

RIDGELINE

HONDA
The Power of Dreams

2018
OWNER'S MANUAL

California Proposition 65 Warning

WARNING: This product contains or emits chemicals known to the state of California to cause cancer and birth defects or other reproductive harm.

Event Data Recorders

This vehicle is equipped with an event data recorder (EDR).

The main purpose of an EDR is to record, in certain crash or near crash-like situations, such as an air bag deployment or hitting a road obstacle, data that will assist in understanding how a vehicle's systems performed. **The EDR is designed to record data related to vehicle dynamics and safety systems for a short period of time, typically 30 seconds or less. The EDR in this vehicle is designed to record such data as:**

- **How various systems in your vehicle were operating;**
- **Whether or not the driver and passenger safety belts were buckled/fastened;**
- **How far (if at all) the driver was depressing the accelerator and/or brake pedal; and,**
- **How fast the vehicle was traveling.**

These data can help provide a better understanding of the circumstances in which crashes and injuries occur. NOTE: EDR data are recorded by your vehicle only if a non-trivial crash situation occurs; no data are recorded by the EDR under normal driving conditions and no personal data (e.g., name, gender, age, and crash location) are recorded. However, other parties, such as law enforcement, could combine the EDR data with the type of personally identifying data routinely acquired during a crash investigation.

To read data recorded by an EDR, special equipment is required, and access to the vehicle or the EDR is needed. In addition to the vehicle manufacturer, other parties, such as law enforcement, that have the special equipment, can read the information if they have access to the vehicle or the EDR.

The data belongs to the vehicle owner and may not be accessed by anyone else except as legally required or with the permission of the vehicle owner.

Service Diagnostic Recorders

This vehicle is equipped with service-related devices that record information about powertrain performance. The data can be used to verify emissions law requirements and/or help technicians diagnose and solve service problems. It may also be combined with data from other sources for research purposes, but it remains confidential. Some diagnostic and maintenance information is uploaded to Honda upon vehicle start up.

California Perchlorate Contamination Prevention Act

The airbags, seat belt tensioners, and CR type batteries in this vehicle may contain perchlorate materials - special handling may apply. See www.dtsc.ca.gov/hazardouswaste/perchlorate/

As you read this manual, you will find information that is preceded by a **NOTICE** symbol. This information is intended to help you avoid damage to your vehicle, other property, or the environment.

Software End User License Agreement

Your vehicle comes equipped with software, which is governed by the End User License Agreement in Owner's Manual, and which contains a binding arbitration clause. Please refer to the End User License Agreement for the terms and conditions governing your use of the installed software, as well as the applications, services, functions, and content provided through the software. Your use of the installed software will serve as your consent to the terms and conditions of the End User License Agreement.

You may opt out within 30 days of your initial use of the Software by sending a signed, written notice to HONDA at American Honda Motor Co., Inc. Honda Automobile Customer Services Mail Stop 100-5E-8A, 1919 Torrance Blvd. Torrance, CA 90501-2746.

Privacy Notice

This vehicle may share location and usage information. To manage this setting, visit www.hondalink.com/vehicle-data-choices.

A Few Words About Safety

Your safety, and the safety of others, is very important. And operating this vehicle safely is an important responsibility.

To help you make informed decisions about safety, we have provided operating procedures and other information on labels and in this manual. This information alerts you to potential hazards that could hurt you or others.

Of course, it is not practical or possible to warn you about all the hazards associated with operating or maintaining your vehicle. You must use your own good judgment.

You will find this important safety information in a variety of forms, including:

- **Safety Labels** - on the vehicle.
- **Safety Messages** - preceded by a safety alert symbol  and one of three signal words: **DANGER**, **WARNING**, or **CAUTION**. These signal words mean:

 You **WILL** be **KILLED** or **SERIOUSLY HURT** if you don't follow instructions.

 You **CAN** be **KILLED** or **SERIOUSLY HURT** if you don't follow instructions.

 You **CAN** be **HURT** if you don't follow instructions.

- **Safety Headings** - such as Important Safety Precautions.
- **Safety Section** - such as Safe Driving.
- **Instructions** - how to use this vehicle correctly and safely.

This entire book is filled with important safety information - please read it carefully.

This owner's manual should be considered a permanent part of the vehicle and should remain with the vehicle when it is sold.

This owner's manual covers all models of your vehicle. You may find descriptions of equipment and features that are not on your particular model.

Images throughout this owner's manual (including the front cover) represent features and equipment that are available on some, but not all, models. Your particular model may not have some of these features.

This owner's manual is for vehicles sold in the United States and Canada.

The information and specifications included in this publication were in effect at the time of approval for printing. Honda Motor Co., Ltd. reserves the right, however, to discontinue or change specifications or design at any time without notice and without incurring any obligation.

➤ Safe Driving P. 29

For Safe Driving P. 30 Seat Belts P. 35 Airbags P. 42

➤ Instrument Panel P. 73

Indicators P. 74 Gauges and Multi-Information Display P. 103

➤ Controls P. 109

Clock P. 110 Locking and Unlocking the Doors P. 111
Security System P. 133 Opening and Closing the Windows P. 136
Adjusting the Mirrors P. 161 Adjusting the Seats P. 163
Heating and Cooling System* P. 195

➤ Features P. 199

Audio System P. 200
General Information on the Audio System P. 298
HomeLink® Universal Transceiver* P. 348 Bluetooth® HandsFreeLink® P. 351, 376

➤ Driving P. 409

Before Driving P. 410 Towing a Trailer P. 418
Parking Your Vehicle P. 501 Multi-View Rear Camera P. 510

➤ Maintenance P. 517

Before Performing Maintenance P. 518 Maintenance Minder™ P. 521
Checking and Maintaining Wiper Blades P. 543
Heating and Cooling System*/Climate Control System* Maintenance P. 556

➤ Handling the Unexpected P. 565

Tools P. 566 If a Tire Goes Flat P. 567
Overheating P. 583 Indicator, Coming On/Blinking P. 585
When You Cannot Unlock the Fuel Fill Door P. 595

➤ Information P. 599

Specifications P. 600 Identification Numbers P. 602
Emissions Testing P. 605 Warranty Coverages P. 607

Contents

Child Safety P. 55

Exhaust Gas Hazard P. 70

Safety Labels P. 71

Opening and Closing the Tailgate P. 128
Opening and Closing the Moonroof* P. 140
Interior Lights/Convenience Items P. 171

Opening and Closing the Trunk P. 130
Operating the Switches Around the Steering Wheel P. 142
Climate Control System* P. 188

Audio System Basic Operation P. 206, 224
Customized Features P. 317

Audio Error Messages P. 294

Off-Highway Driving Guidelines P. 430
Refueling P. 512

When Driving P. 432
Fuel Economy and CO₂ Emissions P. 515

Braking P. 488

Maintenance Under the Hood P. 525
Checking and Maintaining Tires P. 545
Cleaning P. 557

Replacing Light Bulbs P. 537
Battery P. 554
Accessories and Modifications P. 563

Remote Transmitter Care P. 555

Engine Does Not Start P. 576
Fuses P. 589
Refueling P. 596

Jump Starting P. 579
Emergency Towing P. 594

Shift Lever Does Not Move P. 582

Devices that Emit Radio Waves P. 603
Authorized Manuals P. 609

Reporting Safety Defects P. 604
Customer Service Information P. 610

Quick Reference Guide P. 4

Safe Driving P. 29

Instrument Panel P. 73

Controls P. 109

Features P. 199

Driving P. 409

Maintenance P. 517

Handling the Unexpected P. 565

Information P. 599

Index P. 611

Visual Index

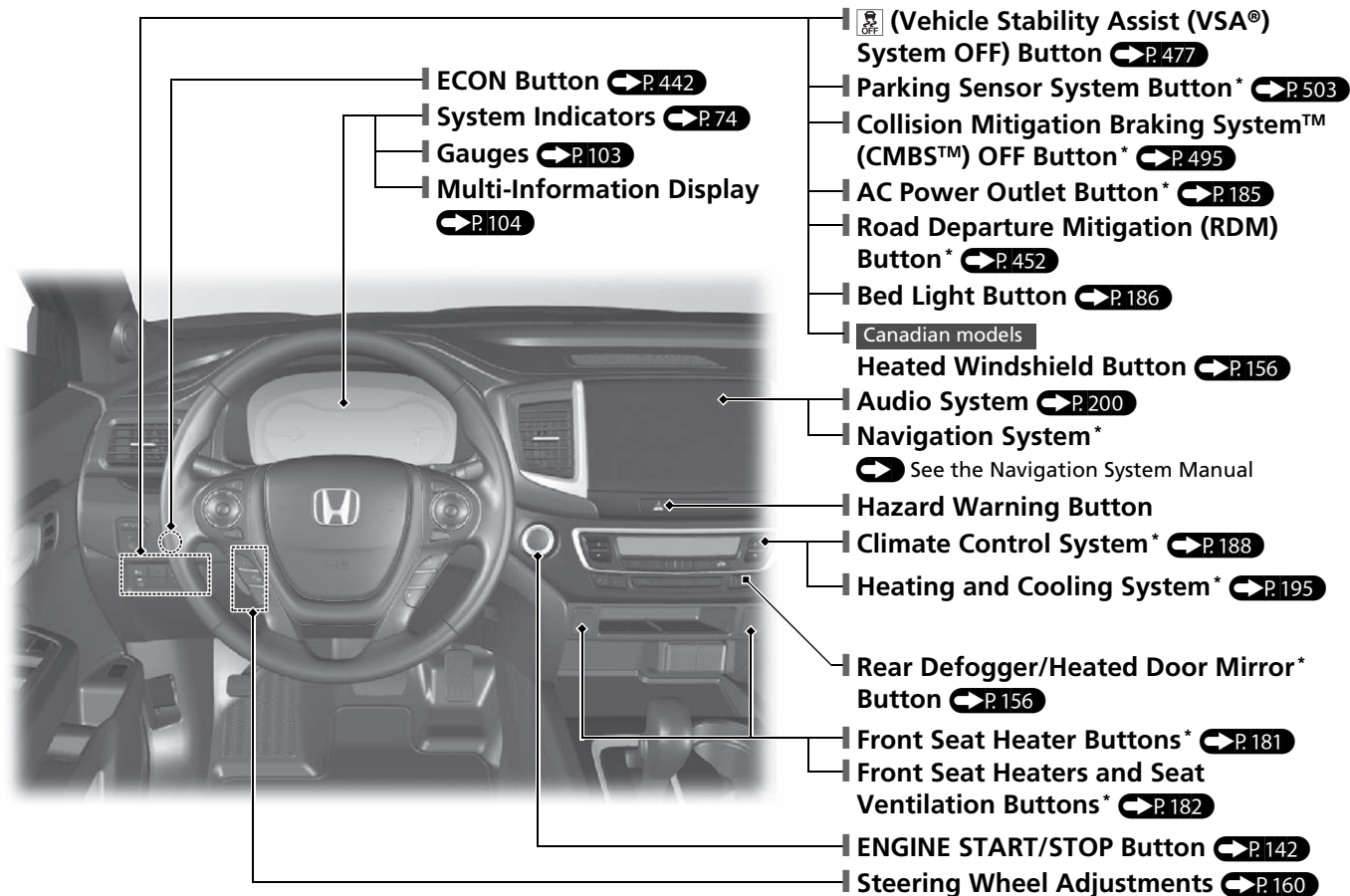

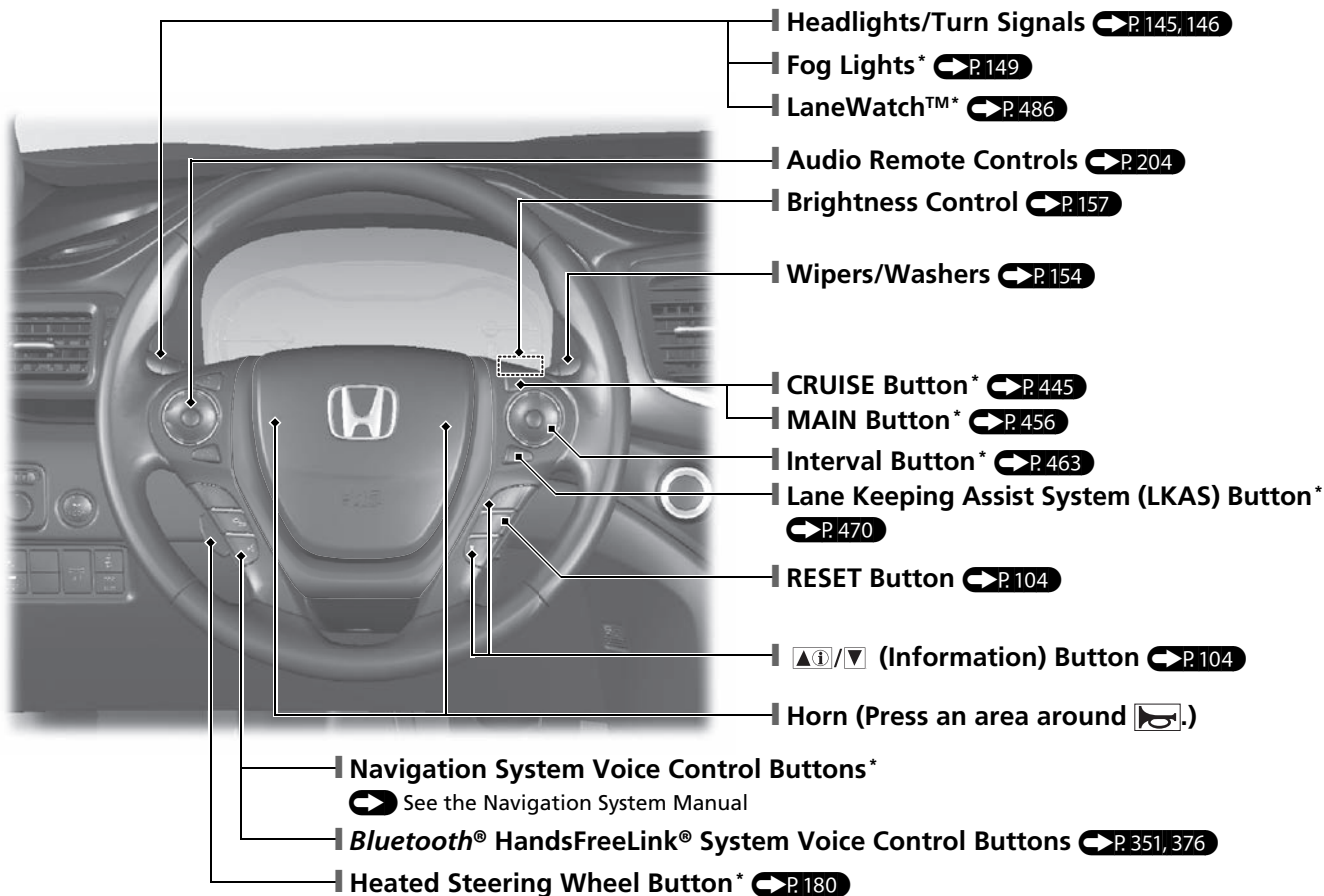

Visual Index

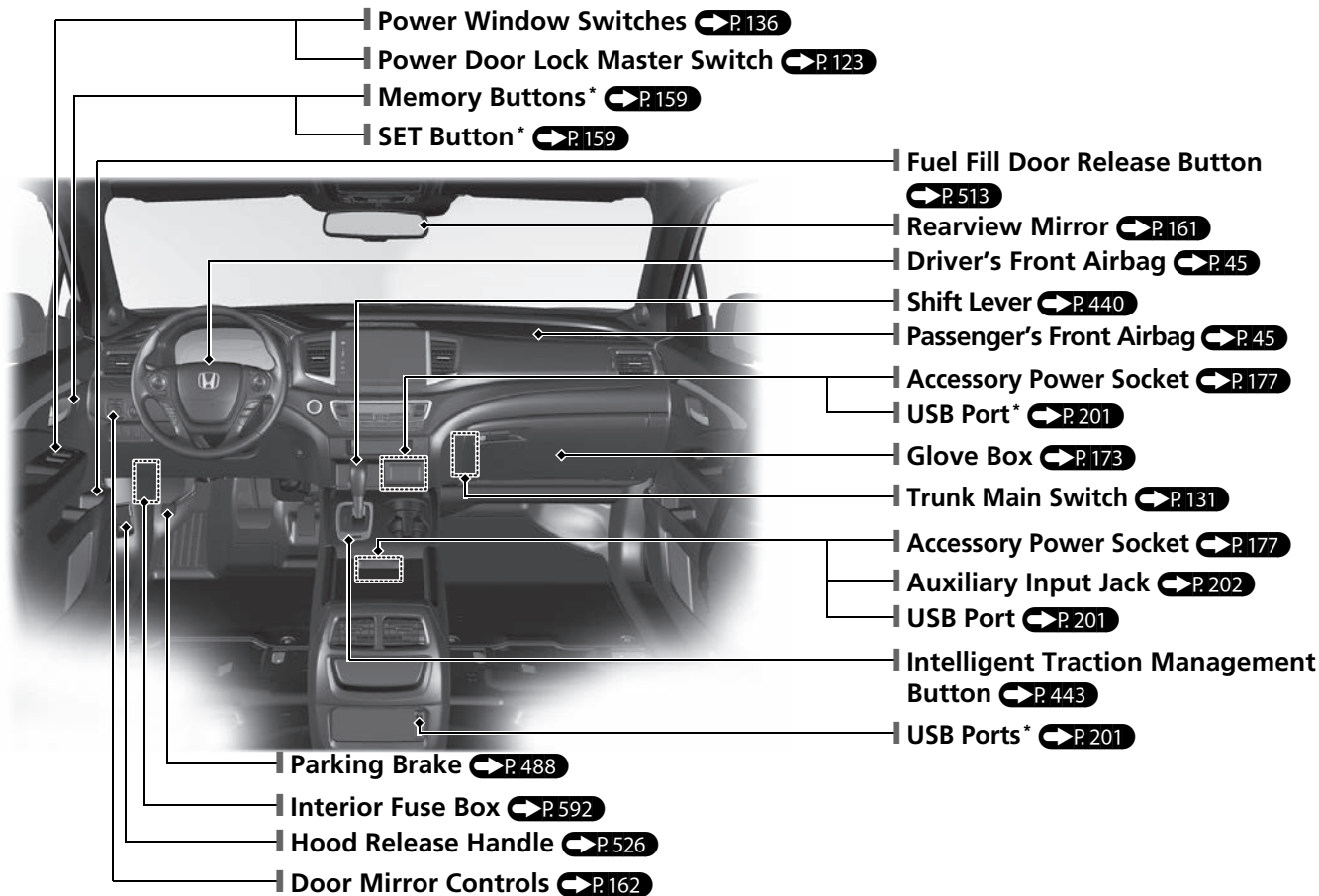

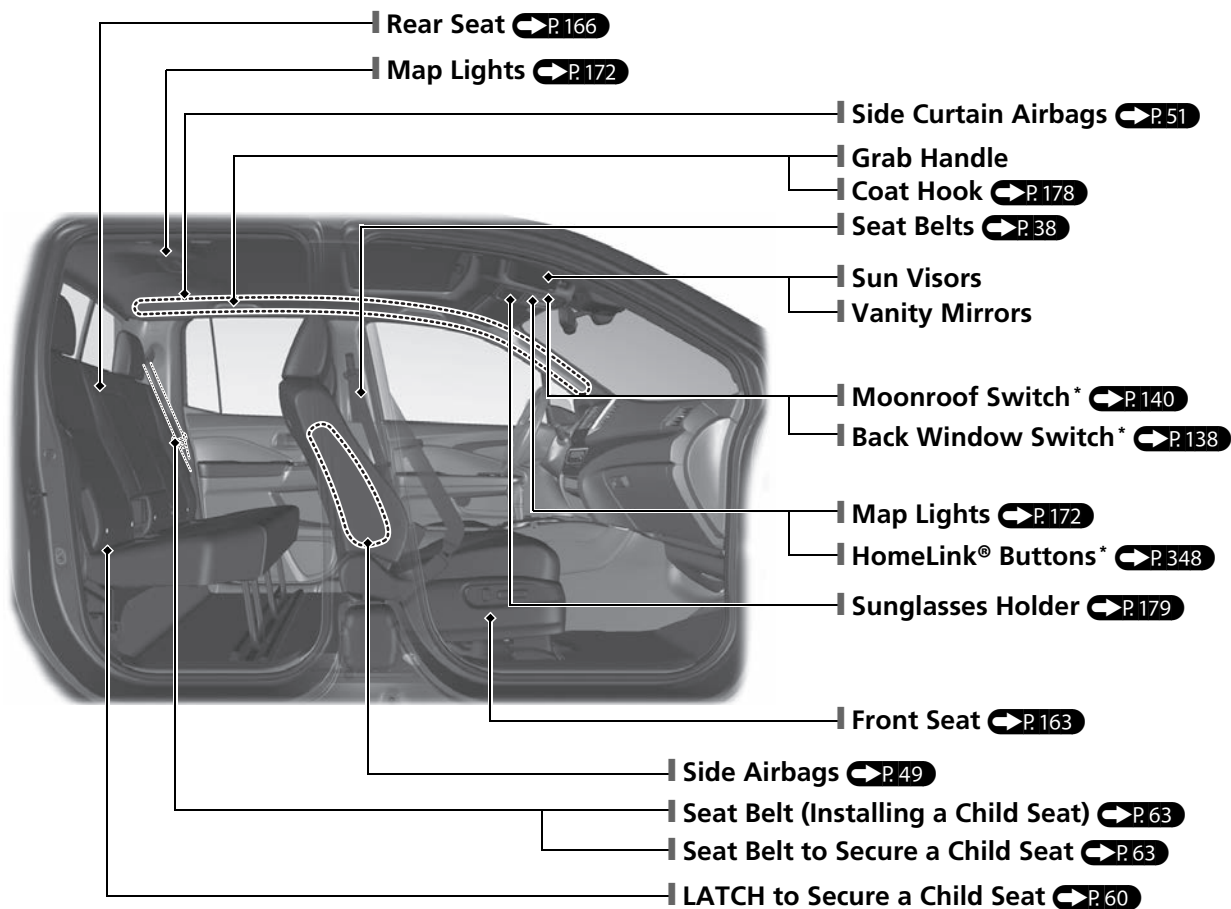

Visual Index

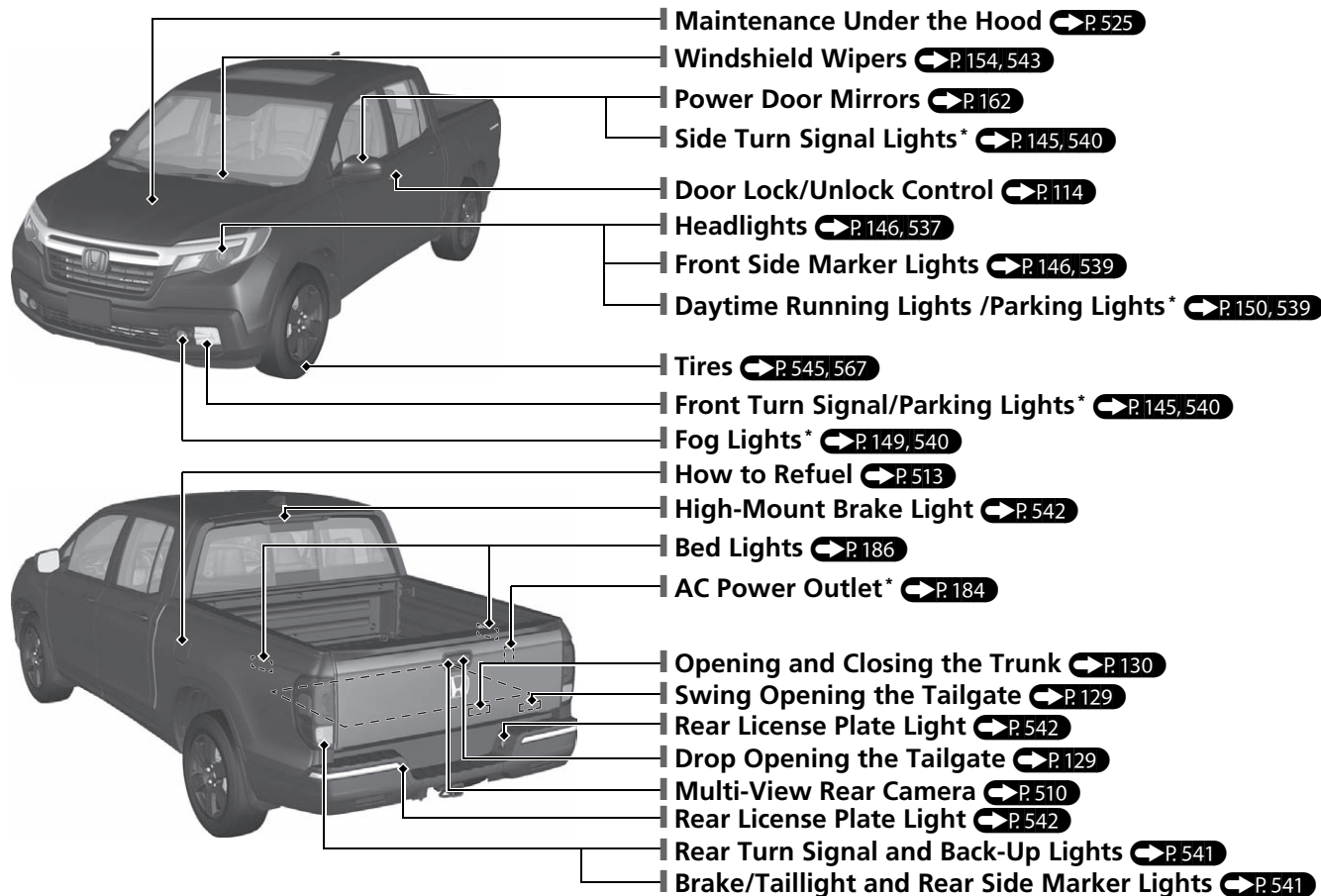

Eco Assist[®] System

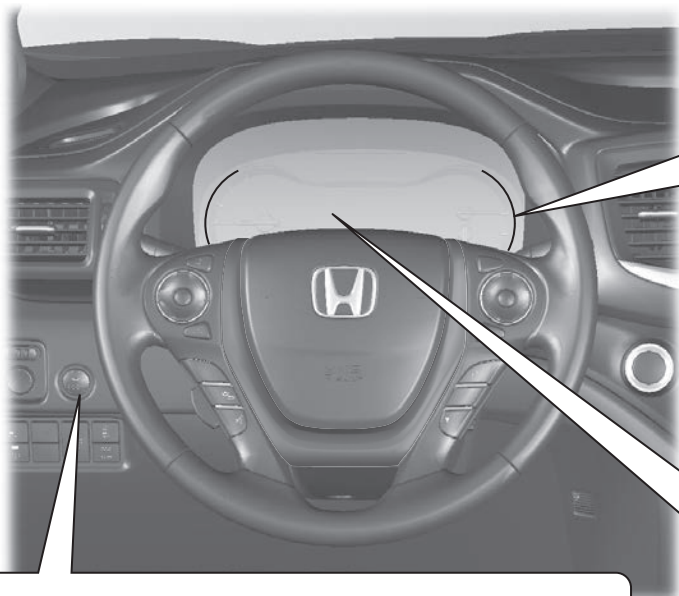

Ambient Meter

- Changes color to reflect your driving style.
 - Green:** Fuel efficient driving
 - Light green:** Moderate acceleration/deceleration
 - White:** Aggressive acceleration/deceleration
- The ambient meter color changes in accordance with your brake or accelerator pedal operation.



ECON Button  **P.442**
Helps maximize fuel economy.



ECON Mode Indicator

 **P.87**

Comes on when the ECON button is pressed.

Safe Driving P.29

Airbags P.42

- Your vehicle is fitted with airbags to help protect you and your passengers during a moderate-to-severe collision.

Child Safety P.55

- All children 12 and younger should be seated in the rear seat.
- Smaller children should be properly restrained in a forward-facing child seat.
- Infants must be properly restrained in a rear-facing child seat.

Exhaust Gas Hazard P.70

- Your vehicle emits dangerous exhaust gases that contain carbon monoxide. Do not run the engine in confined spaces where carbon monoxide gas can accumulate.

Seat Belts P.35

- Fasten your seat belt and sit upright well back in the seat.
- Check that your passengers are wearing their seat belts correctly.

Before Driving Checklist P.34

- Before driving, check that the front seats, head restraints, steering wheel, and mirrors have been properly adjusted.

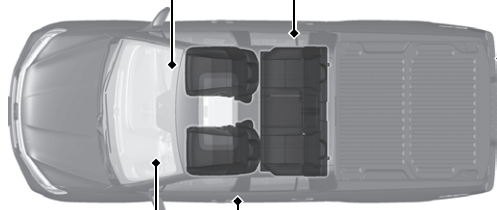















Fasten your lap belt as low as possible.

Instrument Panel P.73



Gauges P.103 / Multi-Information Display P.104 / System Indicators P.74

System Indicators

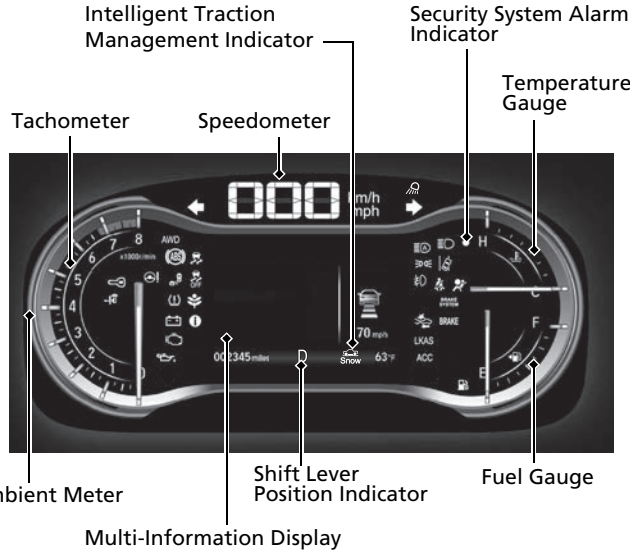



-  Blind spot information (BSI) Indicator*
-  Electric Power Steering (EPS) System Indicator
-  Malfunction Indicator Lamp
-  Low Oil Pressure Indicator
-  **AWD** All-wheel drive system (AWD) Indicator*
-  Vehicle Stability Assist (VSA®) System Indicator
-  **VSA OFF** Indicator
-  Immobilizer System Indicator
-  Smart Entry System Indicator
-  Charging System Indicator
-  Low Tire Pressure/TPMS Indicator
-  System Message Indicator
-  **ECON** Mode Indicator
-  **LKAS** Auto high-beam Indicator*
-  Lane Keeping Assist System (LKAS) Indicator*













System Indicators

-  Collision Mitigation Braking System™ (CMBS™) Indicator*
-  Road Departure Mitigation (RDM) Indicator*

Lights Indicators

-  Lights On Indicator
-  High Beam Indicator
-  Fog Light Indicator*
-  Bed Lights On Indicator

System Indicators

- ACC** Adaptive Cruise Control (ACC) Indicator*
-  **CRUISE MAIN** Indicator*
-  **CRUISE CONTROL** Indicator*
-  Turn Signal and Hazard Warning Indicators
-  Supplemental Restraint System Indicator
-  **(ABS)** Anti-lock Brake System (ABS) Indicator
- BRAKE** U.S. Parking Brake and Brake System Indicator (Red)
Canada 
- BRAKE SYSTEM** U.S. Brake System Indicator (Amber)
Canada 
-   Low Fuel Indicator
-   Seat Belt Reminder Indicator





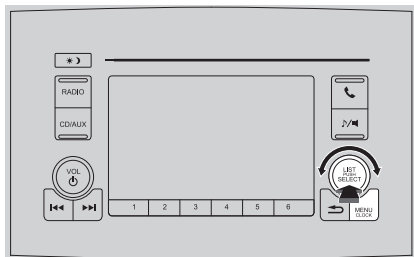

* Not available on all models

Controls P.109

Clock P.110



Models with color audio system



- 1 Press and hold the **MENU/CLOCK** button for two seconds.
- 2 Select **Adjust Clock**, then press .
- 3 Rotate  to adjust the hours.
- 4 Press  to switch to minute adjustment.
- 5 Rotate  to adjust the minutes.
- 6 Press  to switch to Set.
- 7 Press  to complete clock adjustment.

Models with Display Audio



- 1 Select , then select **Settings**.
- 2 Select **Clock/Info**, then **Clock Adjustment**.
- 3 Adjust the dates, hours and minutes by selecting /.
- 4 Select **OK** to set the time.

ENGINE START/STOP Button P.142

Press the button to change the vehicle's power mode.



Turn Signals P.145

Turn Signal Control Lever



Lights P.146

Light Control Switches

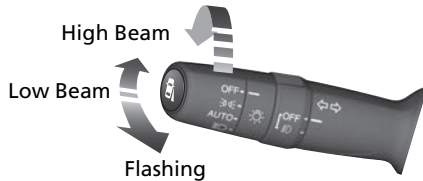

Wipers and Washers

 P.154

Wiper/Washer Control Lever

MIST
OFF

AUTO*1: Wiper speed varies automatically

INT*2: Low speed with intermittent

LO: Low speed wipe

HI: High speed wipe

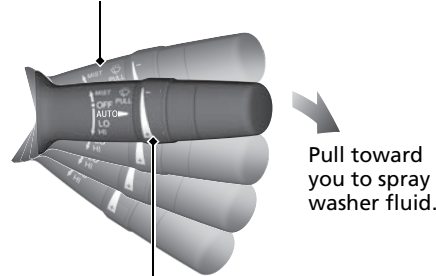

Pull toward you to spray washer fluid.

Adjustment Ring

: Low Sensitivity*1

: Lower speed, fewer sweeps*2

: High Sensitivity*1

: Higher speed, more sweeps*2

*1: Models with automatic intermittent wipers

*2: Models without automatic intermittent wipers

Models with automatic intermittent wipers

AUTO should always be turned **OFF** before cleaning the windshield or driving through a car wash.

Steering Wheel P.160

- To adjust, push the adjustment lever down, adjust to the desired position, then pull up the lever back in place.

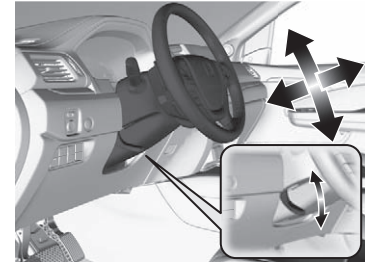

Unlocking the Front Doors from the Inside

➔ P.122

- Pull either front door inner handle to unlock and open it at the same time.



Trunk ➔ P.130

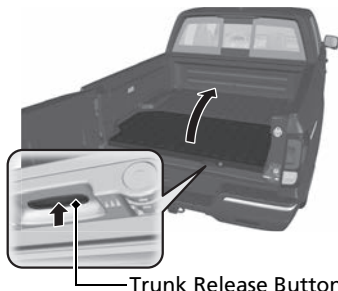

- Press the trunk release button to unlock and open the trunk when you are carrying the smart entry remote.

Power Door Mirrors

➔ P.162

- With the power mode in ON, move the selector switch to L or R.
- Push the appropriate edge of the adjustment switch to adjust the mirror.
- Press the folding button* to fold in and out the door mirrors.

Folding Button* Selector Switch

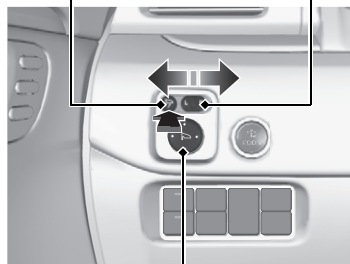

Adjustment Switch

Power Windows ➔ P.136

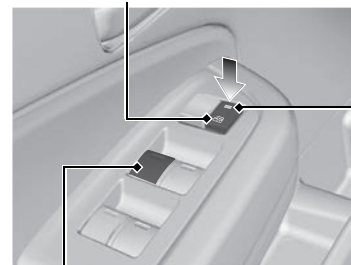

- With the power mode in ON, open and close the power windows.
- If the power window lock button is in the off position, each passenger's window can be opened and closed with its own switch.
- If the power window lock button is in the on position (indicator is on), each passenger's window switch is disabled.

Power Window Lock Button Indicator



Window Switch





Climate Control System* P.188

- Press the **AUTO** button to activate the climate control system.
- Press the  button to turn the system on or off.
- Press the  button to defrost the windshield.

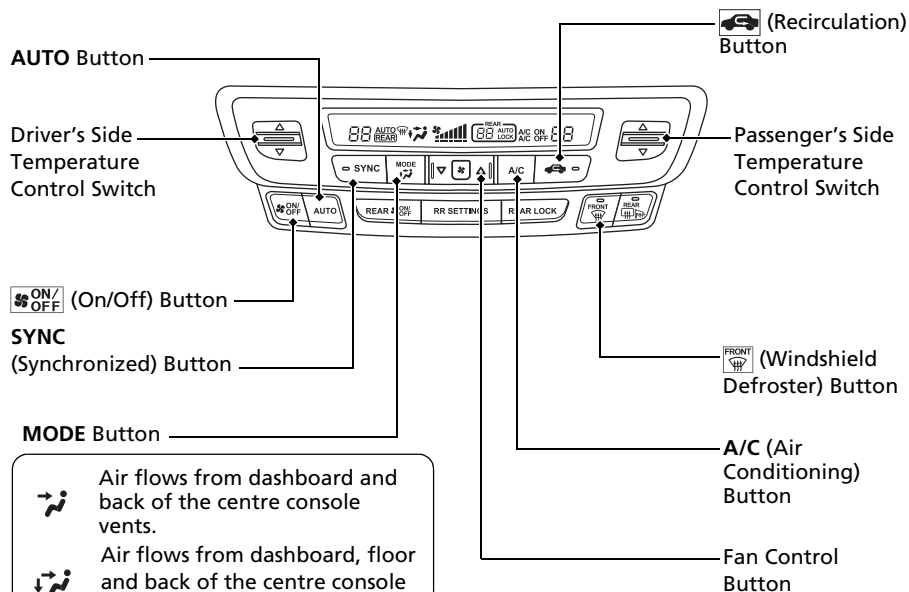
Models with navigation system

The climate control system is voice operable.  P.245





-  Air flows from dashboard and back of the centre console vents.
-  Air flows from dashboard, floor and back of the centre console vents.
-  Air flows from floor vents.
-  Air flows from floor and windshield defroster vents.

Rear Climate Control* P.193

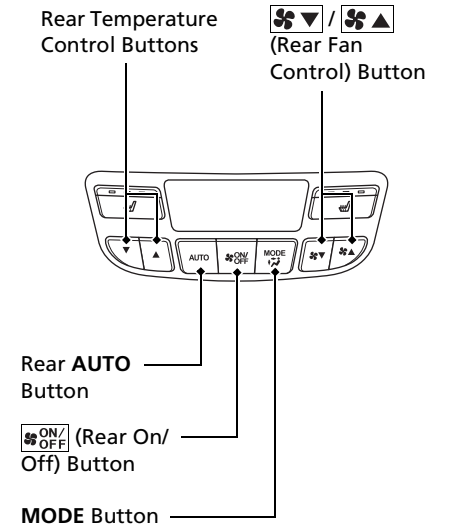

- Press the **AUTO** button to activate the rear climate control system.
- Press the  button to turn the system on or off.



-  Air flows from the rear console vents.
-  Air flow from the rear console vents and floor vents.
-  Air flows from the rear floor vents.

* Not available on all models

Heating and Cooling System*

- Toggle up and down the fan control switch to adjust the fan speed.
- Press the Mode button to select the vents air flows from.
- Toggle up and down the temperature control switch to adjust the temperature.
- Use the  button for maximum cool setting.
- Press the  button to turn the system on or off.
- Press the  button to defrost the windshield.

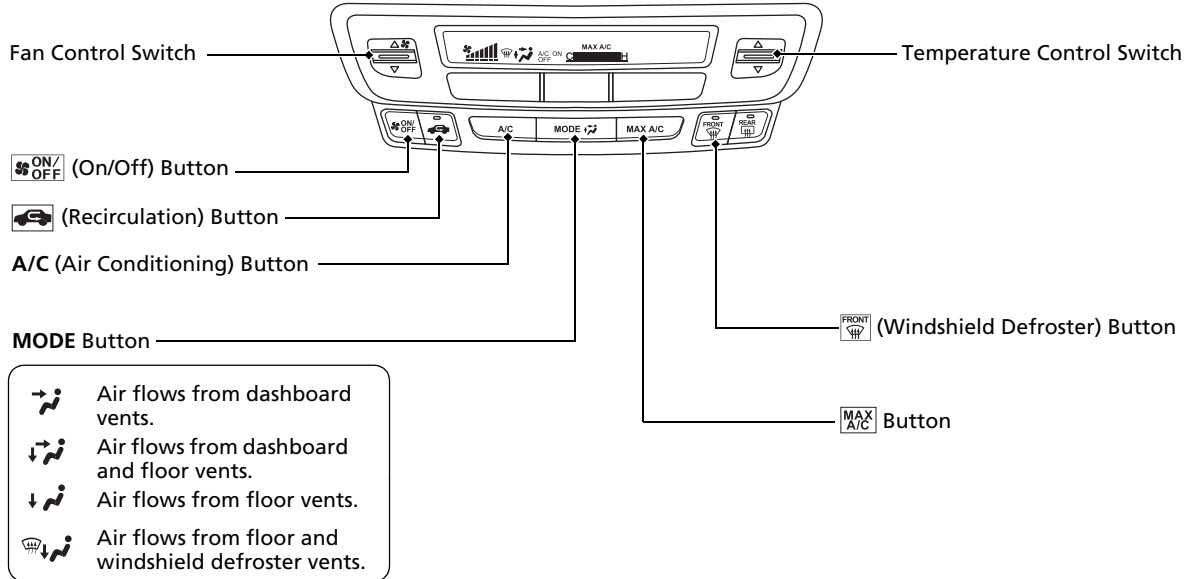

Features P.199

Audio system P.200

Models with color audio system

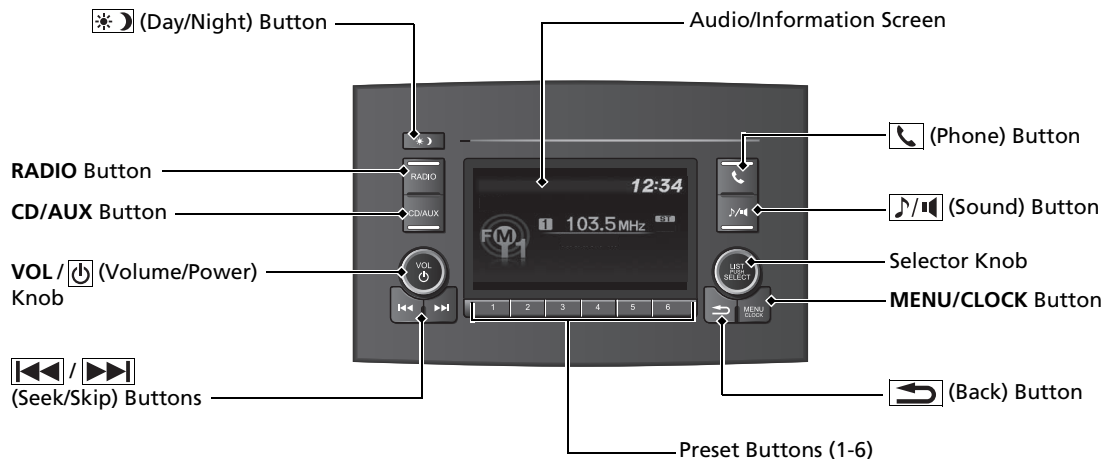

Models with Display Audio

For navigation system operation  See the Navigation System Manual

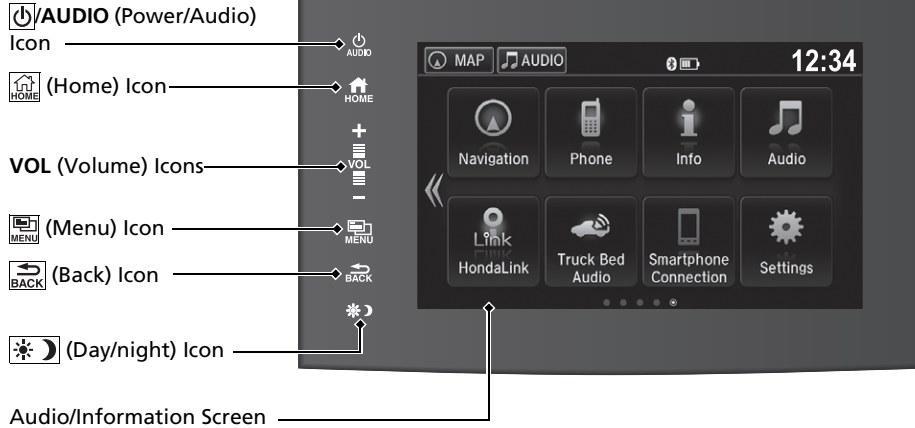

Multi-Information Display



Canadian models

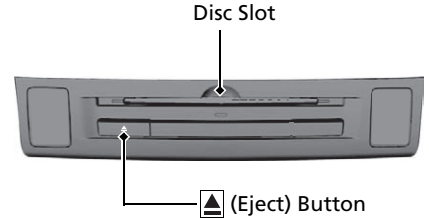

Audio Remote Controls

➔ P.204

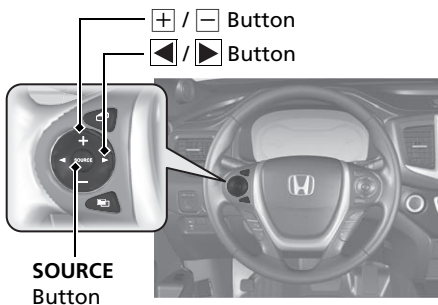

- + / - Button
Press to adjust the volume up/down.
- SOURCE Button

Models with color audio system

Press to change the audio mode:
FM1/FM2/AM/USB/iPod/
Bluetooth® Audio/AUX

Models with Display Audio

Press to change the audio mode:
FM/AM/SiriusXM*/CD*/USB/iPod/
Pandora®*/Bluetooth® Audio/AUX

- < / > Button
Radio: Press to change the preset station.
Press and hold to select the next or previous strong station.

CD*/USB device:

Press to skip to the beginning of the next song or return to the beginning of the current song.
Press and hold to change a folder.

Driving P.409

Automatic Transmission P.440

- Shift to **P** and depress the brake pedal when starting the engine.

● Shifting

P **Park**
Turn off or start the engine.
Transmission is locked.

R **Reverse**
Used when reversing.

N **Neutral**
Transmission is not locked.

D **Drive**
Normal driving.

L **Low**

- Strong engine power when climbing and strong engine braking when going down steep hills.

D4 **Drive (D4)**
Press the **D4** button while the shift lever is in **D**.
Used when:

- Going up or down hills.
- Towing a trailer in hilly terrain.

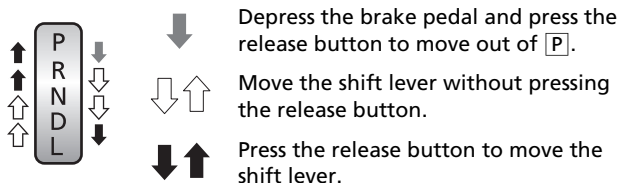
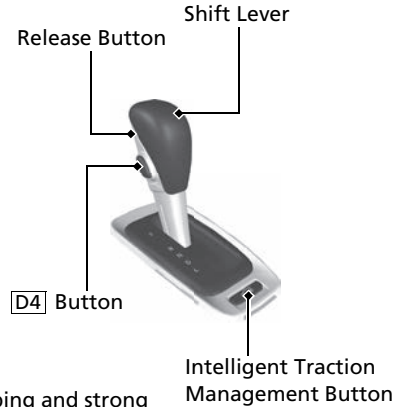

VSA® OFF Button P. 477

- The vehicle stability assist (VSA®) system helps stabilize the vehicle during cornering, and helps maintain traction while accelerating on loose or slippery road surfaces.
- VSA® comes on automatically every time you start the engine.
- To partially disable or fully restore VSA® function, press and hold the button until you hear a beep.

Cruise Control* P. 445

- Cruise control allows you to maintain a set speed without keeping your foot on the accelerator pedal.
- To use cruise control, press the **CRUISE** button, then press the **-/SET** button once you have achieved the desired speed (above 25 mph or 40 km/h).

Collision Mitigation Braking System™ (CMBS™) OFF Button*

 P. 495

- When a possible collision is likely unavoidable, the CMBS™ can help you to reduce the vehicle speed and the severity of the collision.
- To turn the CMBS™ on or off, press and hold the button until you hear a beep.

Tire Pressure Monitoring System (TPMS) P. 480, 588

- TPMS monitors tire pressure.
- TPMS is turned on automatically every time you start the engine.
- TPMS fill assist provides audible and visual guidance during tire pressure adjustment.

Refueling P. 512

Fuel recommendation: Unleaded gasoline with a pump octane number 87 or higher recommended

Fuel tank capacity: 19.5 US gal (73.8 ℓ)

- 1 Press the fuel fill door release button.



- 2 After refueling, wait for about five seconds before removing the filler nozzle.

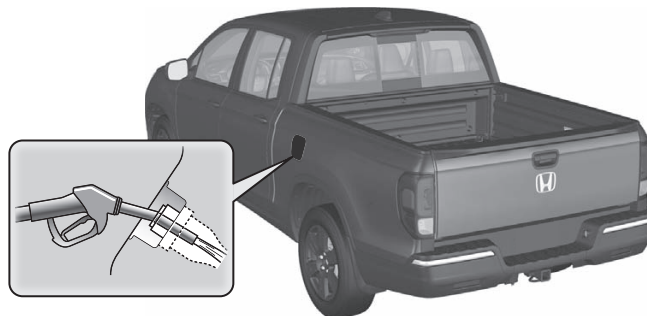

Honda Sensing™*

Honda Sensing™ is a driver support system which employs the use of two distinctly different kinds of sensors, a radar sensor located in the front grille and a front sensor camera mounted to the interior side of the windshield, behind the rear view mirror.

The camera is located behind the rearview mirror.

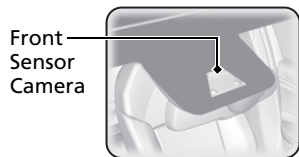

Front Sensor Camera

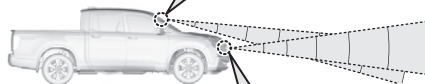

Radar Sensor



The radar sensor is inside the front grille.

Adaptive Cruise Control (ACC)* P. 455

Helps maintain a constant vehicle speed and a set following interval behind a vehicle detected ahead of yours, without you having to keep your foot on the brake or the accelerator.

Road Departure Mitigation (RDM) System* P. 450

Alerts and helps to assist you when the system detects a possibility of your vehicle unintentionally crossing over detected lane markings and/or leaving the roadway altogether.

Lane Keeping Assist System (LKAS)* P. 463

Provides steering input to help keep the vehicle in the middle of a detected lane and provides tactile and visual alerts if the vehicle is detected drifting out of its lane.

Collision Mitigation Braking System™ (CMBS™)* P. 492

Can assist you when there is a possibility of your vehicle colliding with a vehicle or a pedestrian detected in front of yours. The CMBS™ is designed to alert you when a potential collision is determined, as well as to reduce your vehicle speed to help minimize collision severity when a collision is deemed unavoidable.

Maintenance ↔ P.517

Under the Hood ↔ P.525

- Check engine oil, engine coolant, and windshield washer fluid. Add when necessary.
- Check brake fluid.
- Check the battery condition monthly.

- 1** Pull the hood release handle under the corner of the dashboard.



- 2** Locate the hood latch lever, pull the lever up, and lift up the hood.

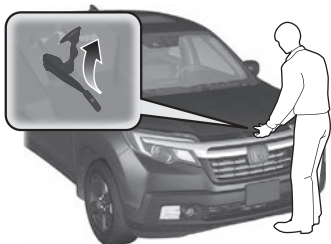

- 3** When finished, close the hood and make sure it is firmly locked in place.

Wiper Blades ↔ P.543

- Replace blades if they leave streaks across the windshield.



Tires ↔ P.545

- Inspect tires and wheels regularly.
- Check tire pressures regularly.
- Install snow tires for winter driving.

Lights ↔ P.537

- Inspect all lights regularly.

Handling the Unexpected P.565

Flat Tire P.567

- Park in a safe location and replace the flat tire with the compact spare tire located in the trunk.



Engine Won't Start P.576

- If the battery is dead, jump start using a booster battery.

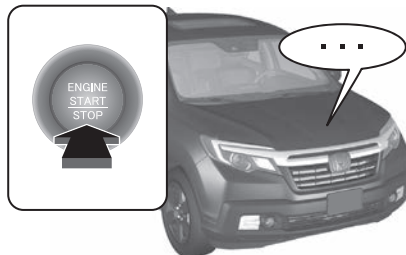

Overheating P.583

- Park in a safe location. If you do not see steam under the hood, open the hood, and let the engine cool down.



Indicators Come On P.585

- Identify the indicator and consult the owner's manual.

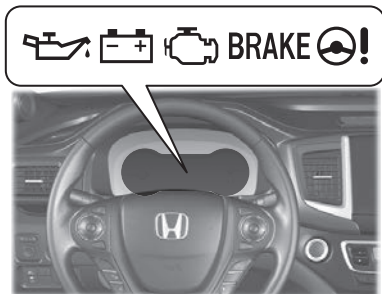

Blown Fuse P.589

- Check for a blown fuse if an electrical device does not operate.

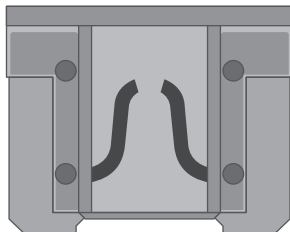

Emergency Towing P.594

- Call a professional towing service if you need to tow your vehicle.



What to Do If

Q Canadian models
The power mode does not change from **VEHICLE OFF (LOCK)** to **ACCESSORY**. Why?

A

- The steering wheel may be locked.
- Move the steering wheel left and right after pressing the **ENGINE START/STOP** button.



Q The power mode does not change from **ON** to **VEHICLE OFF (LOCK)**. Why?

A The shift lever should be moved to **P**.



Q Why does the brake pedal pulsate slightly when applying the brakes?

A This can occur when the ABS activate and does not indicate a problem. Apply firm, steady pressure on the brake pedal. Never pump the brake pedal.

▶ ABS operation ➔ **P.490**

Q The rear door cannot be opened from inside the vehicle. Why?

A Check if the childproof lock is in the lock position. If so, open the rear door with the outside door handle. To cancel this function, push the lever to the unlock position.

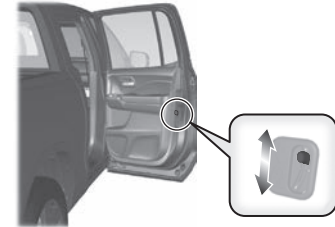

Q Why do the doors lock after I unlocked the doors?

A If you do not open the doors within 30 seconds, the doors are relocked automatically for security.

Q Why does the beeper sound when I open the driver's door?

A The beeper sounds when:

- The exterior lights are left on.
- The power mode is in ACCESSORY.

Q Why does the beeper sound when I start driving?

A The beeper sounds when:

- Driver and/or front passenger are not wearing their seat belts.
- The parking brake pedal is not fully released.

Q Why do I hear a screeching sound when I apply the brake pedal?

A The brake pads may need to be replaced. Have your vehicle inspected by a dealer.

Q

I'm seeing an amber indicator of a tire with an exclamation point. What is that?

A

The Tire Pressure Monitoring System (TPMS) needs attention. Check tire pressure.

▶ If the Low Tire Pressure/Tire Pressure Monitoring System (TPMS) Indicator Comes On or Blinks  **P. 588**

Safe Driving

You can find many safety recommendations throughout this chapter, and throughout this manual.

For Safe Driving

Important Safety Precautions.....	30
Important Handling Information.....	32
Your Vehicle's Safety Features.....	33
Safety Checklist	34

Seat Belts

About Your Seat Belts	35
Fastening a Seat Belt	38
Seat Belt Inspection.....	41

Airbags

Airbag System Components.....	42
Types of Airbags	45
Front Airbags (SRS)	45
Side Airbags.....	49
Side Curtain Airbags	51
Airbag System Indicators.....	52
Airbag Care	54

Child Safety

Protecting Child Passengers	55
Safety of Infants and Small Children	57
Safety of Larger Children	68

Exhaust Gas Hazard

Carbon Monoxide Gas.....	70
--------------------------	----

Safety Labels

Label Locations.....	71
----------------------	----

The following pages explain your vehicle's safety features and how to use them properly. The safety precautions below are ones that we consider to be among the most important.

Important Safety Precautions

■ Always wear your seat belt

A seat belt is your best protection in all types of collisions. Airbags are designed to supplement seat belts, not replace them. So even though your vehicle is equipped with airbags, make sure you and your passengers always wear your seat belts, and wear them properly.

■ Restrain all children

Children ages 12 and under should ride properly restrained in a back seat, not the front seat. Infants and small children should be restrained in a child seat. Larger children should use a booster seat and a lap/shoulder seat belt until they can use the belt properly without a booster seat.

■ Be aware of airbag hazards

While airbags can save lives, they can cause serious or fatal injuries to occupants who sit too close to them, or are not properly restrained. Infants, young children, and short adults are at the greatest risk. Be sure to follow all instructions and warnings in this manual.

■ Don't drink and drive

Alcohol and driving don't mix. Even one drink can reduce your ability to respond to changing conditions, and your reaction time gets worse with every additional drink. So don't drink and drive, and don't let your friends drink and drive, either.

▣ Important Safety Precautions

Some states, provinces and territories prohibit the use of cell phones other than hands-free devices by the driver while driving.

■ Pay appropriate attention to the task of driving safely

Engaging in cell phone conversation or other activities that keep you from paying close attention to the road, other vehicles, and pedestrians could lead to a crash. Remember, situations can change quickly, and only you can decide when it is safe to divert some attention away from driving.

■ Control your speed

Excessive speed is a major factor in crash injuries and deaths. Generally, the higher the speed, the greater the risk, but serious injuries can also occur at lower speeds. Never drive faster than is safe for current conditions, regardless of the maximum speed posted.

■ Keep your vehicle in safe condition

Having a tire blowout or a mechanical failure can be extremely hazardous. To reduce the possibility of such problems, check your tire pressures and condition frequently, and perform all regularly scheduled maintenance.

■ Never let passengers ride in the pickup bed or inside a truck cap (shell).

They could be killed or injured in a crash, or become ill or even die from carbon monoxide poisoning if engine exhaust enters the cap.

Important Handling Information

Your vehicle has higher ground clearance than a passenger vehicle designed for use only on pavement. Higher ground clearance has many advantages for off-highway driving. It allows you to travel over bumps, obstacles, and rough terrain. It also provides good visibility so you can anticipate problems earlier.

These advantages come at some cost. Because your vehicle is taller and rides higher off the ground, it has a higher center gravity making it more susceptible to tipping or roll over if you make abrupt turns. Utility vehicles have a significantly higher rollover rate than other types of vehicles. In a rollover crash, an unbelted person is significantly more likely to die than a person wearing a seat belt. As a reminder, make sure you and your passengers always wear seat belts.

► Important Handling Information

For information on how to reduce the risk of rollover, read:

► **Driving Guidelines for Your Utility Vehicle**
P. 438

► **Off-Highway Driving Guidelines** P. 430

Failure to operate your vehicle correctly might result in a crash or a rollover.

Your Vehicle's Safety Features

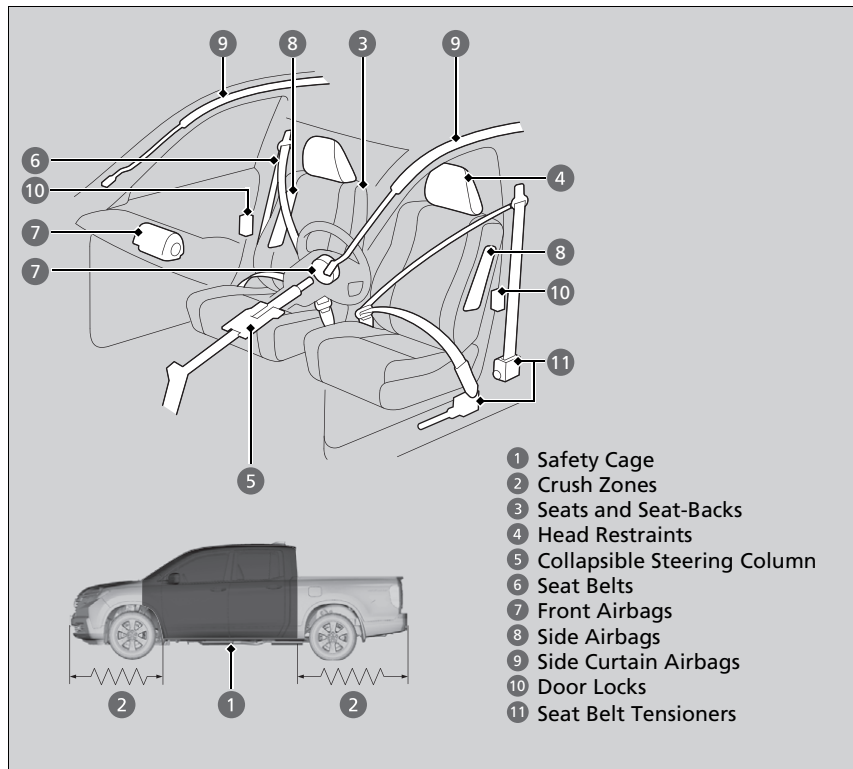

- 1 Safety Cage
- 2 Crush Zones
- 3 Seats and Seat-Backs
- 4 Head Restraints
- 5 Collapsible Steering Column
- 6 Seat Belts
- 7 Front Airbags
- 8 Side Airbags
- 9 Side Curtain Airbags
- 10 Door Locks
- 11 Seat Belt Tensioners

The following checklist will help you take an active role in protecting yourself and your passengers.

▣ Your Vehicle's Safety Features

Your vehicle is equipped with many features that work together to help protect you and your passengers during a crash.

Some features do not require any action on your part. These include a strong steel framework that forms a safety cage around the passenger compartment, front and rear crush zones, a collapsible steering column, and tensioners that tighten the front seat belts in a sufficient crash.

However, you and your passengers cannot take full advantage of these features unless you remain seated in the correct position and always wear your seat belts. In fact, some safety features can contribute to injuries if they are not used properly.

Safety Checklist

For the safety of you and your passengers, make a habit of checking these items each time before you drive.

- After everyone has entered the vehicle, be sure all doors are closed and locked. Locking the doors helps prevent an occupant from being ejected and an outsider from unexpectedly opening a door.
 - ❏ **Locking/Unlocking the Doors from the Inside** P. 121
- Adjust your seat to a position suitable for driving. Be sure the front seats are adjusted as far to the rear as possible while allowing the driver to control the vehicle. Sitting too close to a front airbag can result in serious or fatal injury in a crash.
 - ❏ **Adjusting the Seats** P. 163
- Adjust head restraints to the proper position. Head restraints are most effective when the center of the head restraint aligns with the center of your head. Taller persons should adjust their head restraint to the highest position.
 - ❏ **Adjusting the front head restraint positions** P. 168
- Always wear your seat belt, and make sure you wear it properly. Confirm that any passengers are properly belted as well.
 - ❏ **Fastening a Seat Belt** P. 38
- Protect children by using seat belts or child seats according to a child's age, height and weight.
 - ❏ **Child Safety** P. 55

» Safety Checklist

If the door, trunk and/or tailgate open message appears on the multi-information display, the door, the trunk and/or the tailgate is not completely closed. Close all doors, the trunk and the tailgate tightly until the message disappears.



About Your Seat Belts

Seat belts are the single most effective safety device because they keep you connected to the vehicle so that you can take advantage of many built-in safety features. They also help keep you from being thrown against the inside of the vehicle, against any passengers, or out of the vehicle. When worn properly, seat belts also keep your body properly positioned in a crash so that you can take full advantage of the additional protection provided by the airbags.

In addition, seat belts help protect you in almost every type of crash, including:

- frontal impacts
- side impacts
- rear impacts
- rollovers

■ Lap/shoulder seat belts

All five seating positions are equipped with lap/shoulder seat belts with emergency locking retractors. In normal driving the retractor lets you move freely while keeping some tension on the belt. During a collision or sudden stop the retractor locks to restrain your body.

The front passenger's and rear seat belts also have a lockable retractor for use with child seats.

🔧 **Installing a Child Seat with a Lap/Shoulder Seat Belt** P. 63

🔧 About Your Seat Belts

⚠️ WARNING

Not wearing a seat belt properly increases the chance of serious injury or death in a crash, even though your vehicle has airbags.

Be sure you and your passengers always wear seat belts and wear them properly.

⚠️ WARNING

Allowing passengers to ride in the pickup bed or on the tailgate can result in death or serious injury in a crash.

Make sure all passengers ride in a seat and wear a seat belt properly.

Seat belts cannot completely protect you in every crash. But in most cases, seat belts can reduce your risk of serious injury.

Most states and all Canadian provinces and territories require you to wear seat belts.

If you extend the seat belt too quickly, it will lock in place. If this happens, slightly retract the seat belt, then extend it slowly.

■ Proper use of seat belts

Follow these guidelines for proper use:

- All occupants should sit upright, well back in the seat, and remain in that position for the duration of the trip. Slouching and leaning reduce the effectiveness of the belt and can increase the chance of serious injury in a crash.
- Never place the shoulder part of a lap/shoulder seat belt under your arm or behind your back. This could cause very serious injuries in a crash.
- Two people should never use the same seat belt. If they do, they could be very seriously injured in a crash.
- Do not put any accessories on the seat belts. Devices intended to improve comfort or reposition the shoulder part of a seat belt can reduce the protective capability and increase the chance of serious injury in a crash.

■ Seat Belt Reminder



Your vehicle monitors front seat belt use. If the power mode is set to ON before the driver's seat belt is fastened, the beeper will sound and the indicator will blink. If the driver does not fasten the belt before the beeper stops, the indicator will remain on. The beeper will periodically sound and the indicator will blink while driving until the driver's and/or the front passenger's seat belt is fastened.

▶▶ About Your Seat Belts

If a front and/or rear seat passenger moves around and extends the seat belt, the lockable retractor may activate. If this happens, release the retractor by unfastening the seat belt and allow the belt to retract completely. Then refasten the belt.

The pickup bed is not equipped with seats or seat belts. Do not let anyone ride in the pickup bed as they can easily be thrown out and be killed or seriously injured.

▶▶ Seat Belt Reminder

The indicator will also come on if a front passenger does not fasten their seat belt within six seconds after the power mode is set to ON.

When no one is sitting in the front passenger's seat, the indicator will not come on and the beeper will not sound.

The indicator also may not come on and the beeper may not sound when the occupant is not heavy enough to trigger the weight sensor. Such occupants (e.g., infants and smaller children) should be moved to the rear seat as a deploying front airbag likely will injure or kill them.

▶▶ **Protecting Child Passengers** P. 55

Automatic Seat Belt Tensioners

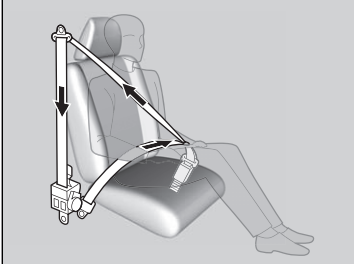

The front seats are equipped with automatic seat belt tensioners to enhance safety.

The tensioners automatically tighten the front seat belts during a moderate-to-severe frontal collision, sometimes even if the collision is not severe enough to inflate the front airbags.

Automatic Seat Belt Tensioners

The seat belt tensioners can only operate once. If a tensioner is activated, the SRS indicator will come on. Have a dealer replace the tensioner and thoroughly inspect the seat belt system as it may not offer protection in a subsequent crash.

During a moderate-to-severe side impact, the tensioner on that side of the vehicle also activates.

Fastening a Seat Belt

After adjusting a front seat to the proper position, and while sitting upright and well back in the seat:

➤ **Adjusting the Seats** P. 163

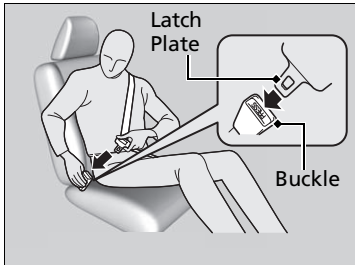
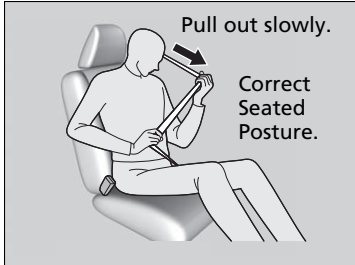

1. Pull the seat belt out slowly.

2. Insert the latch plate into the buckle, then tug on the belt to make sure the buckle is secure.

▶ Make sure that the belt is not twisted or caught on anything.

Fastening a Seat Belt

No one should sit in a seat with an inoperative seat belt or one that does not appear to be working correctly. Using a seat belt that is not working properly may not protect the occupant in a crash. Have a dealer check the belt as soon as possible.

Never insert any foreign objects into the buckle or retractor mechanism.



3. Position the lap part of the belt as low as possible across your hips, then pull up on the shoulder part of the belt so the lap part fits snugly. This lets your strong pelvic bones take the force of a crash and reduces the chance of internal injuries.
4. If necessary, pull up on the belt again to remove any slack, then check that the belt rests across the center of your chest and over your shoulder. This spreads the forces of a crash over the strongest bones in your upper body.

■ Adjusting the Shoulder Anchor

The front seats have adjustable shoulder anchors to accommodate taller and shorter occupants.

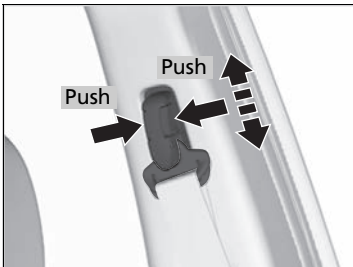

1. Move the anchor up or down while squeezing the release buttons.
2. Position the anchor so that the belt rests across the center of your chest and over your shoulder.

⌘ Fastening a Seat Belt

⚠ WARNING

Improperly positioning the seat belts can cause serious injury or death in a crash.

Make sure all seat belts are properly positioned before driving.

To release the belt, push the red **PRESS** button then guide the belt by hand until it has retracted completely.

When exiting the vehicle, be sure the belt is out of the way and will not get caught by closing the door.

⌘ Adjusting the Shoulder Anchor

The shoulder anchor height can be adjusted to four levels. If the belt contacts your neck, lower the height one level at a time.

After an adjustment, make sure that the shoulder anchor position is secure.

Advice for Pregnant Women

If you are pregnant, the best way to protect yourself and your unborn child when driving or riding in a vehicle is to always wear a seat belt and keep the lap part of the belt as low as possible across the hips.

Wear the shoulder belt across the chest avoiding the abdomen.



Wear the lap part of the belt as low as possible across the hips.

Advice for Pregnant Women

Each time you have a checkup, ask your doctor if it is okay for you to drive.

To reduce the risk of injuries to both you and your unborn child that can be caused by an inflating front airbag:

- When driving, sit upright and adjust the seat as far back as possible while allowing full control of the vehicle.
- When sitting in the front passenger's seat, adjust the seat as far back as possible.

Seat Belt Inspection

Regularly check the condition of your seat belts as follows:

- Pull each belt out fully, and look for frays, cuts, burns, and wear.
- Check that the latch plate and buckles work smoothly and the belts retract easily.
 - ▶ If a belt does not retract easily, cleaning the belt may correct the problem. Only use a mild soap and warm water. Do not use bleach or cleaning solvents. Make sure the belt is completely dry before allowing it to retract.

Any belt that is not in good condition or working properly will not provide proper protection and should be replaced as soon as possible.

A belt that has been worn during a crash may not provide the same level of protection in a subsequent crash. Have your seat belts inspected by a dealer after any collision.

Seat Belt Inspection

⚠ WARNING

Not checking or maintaining seat belts can result in serious injury or death if the seat belts do not work properly when needed.

Check your seat belts regularly and have any problem corrected as soon as possible.

Airbag System Components

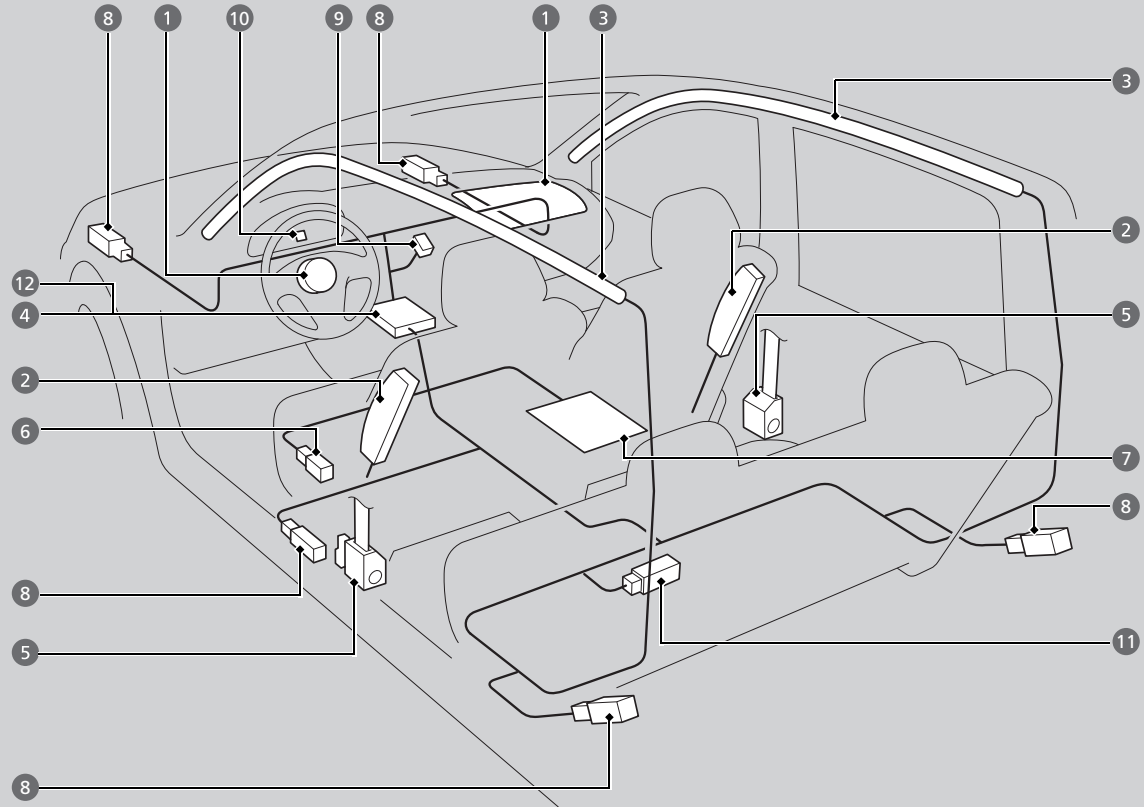

The front, front side, and side curtain airbags are deployed according to the direction and severity of impact. Both side curtain airbags are deployed in a rollover. The airbag system includes:

- ❶ Two SRS (Supplemental Restraint System) front airbags. The driver's airbag is stored in the center of the steering wheel; the front passenger's airbag is stored in the dashboard. Both are marked **SRS AIRBAG**.
- ❷ Two side airbags, one for the driver and one for a front passenger. The airbags are stored in the outer edges of the seat-backs. Both are marked **SIDE AIRBAG**.
- ❸ Two side curtain airbags, one for each side of the vehicle. The airbags are stored in the ceiling, above the side windows. The front and rear pillars are marked **SIDE CURTAIN AIRBAG**.
- ❹ An electronic control unit that, when the vehicle is on, continually monitors information about the various impact sensors, seat and buckle sensors, airbag activators, and seat belt tensioners. During a crash event the unit records such information.
- ❺ Automatic front seat belt tensioners. In addition, the driver's and front passenger's seat belt buckles incorporate sensors that detect whether or not the belts are fastened.
- ❻ A driver's seat position sensor. If the seat is too far forward, the airbag will inflate with less force.
- ❼ Weight sensors in the front passenger's seat. The front passenger's airbag will be turned off if the weight on the seat is approximately 65 lbs (29 kg) or less (the weight of an infant or small child).
- ❽ Impact sensors that can detect a moderate-to-severe front or side impact.
- ❾ An indicator on the dashboard that alerts you that the front passenger's front airbag has been turned off.
- ❿ An indicator on the instrument panel that alerts you to a possible problem with your airbag system or seat belt tensioners.
- ⓫ Safing Sensor
- ⓬ A rollover sensor that can detect if your vehicle is about to roll over and signal the control unit to deploy both side curtain airbags.

■ Important Facts About Your Airbags

Airbags can pose serious hazards. To do their job, airbags must inflate with tremendous force. So, while airbags help save lives, they can cause burns, bruises, and other minor injuries, sometimes even fatal ones if occupants are not wearing their seat belts properly and sitting correctly.

What you should do: Always wear your seat belt properly, and sit upright and as far back from the steering wheel as possible while allowing full control of the vehicle. A front passenger should move their seat as far back from the dashboard as possible.

Remember, however, that no safety system can prevent all injuries or deaths that can occur in a severe crash, even when seat belts are properly worn and the airbags deploy.

Do not place hard or sharp objects between yourself and a front airbag.

Carrying hard or sharp objects on your lap, or driving with a pipe or other sharp object in your mouth, can result in injuries if your front airbag inflates.

Do not attach or place objects on the front airbag covers. Objects on the covers marked **SRS AIRBAG** could interfere with the proper operation of the airbags or be propelled inside the vehicle and hurt someone if the airbags inflate.

▶ Important Facts About Your Airbags

Do not attempt to deactivate your airbags. Together, airbags and seat belts provide the best protection.

When driving, keep hands and arms out of the deployment path of the front airbag by holding each side of the steering wheel. Do not cross an arm over the airbag cover.

Types of Airbags

Your vehicle is equipped with three types of airbags:

- **Front airbags:** Airbags in front of the driver's and front passenger's seats.
- **Side airbags:** Airbags in the driver's and front passenger's seat-backs.
- **Side curtain airbags:** Airbags above the side windows.

Each is discussed in the following pages.

Front Airbags (SRS)

The front SRS airbags inflate in a moderate-to-severe frontal collision to help protect the head and chest of the driver and/or front passenger.

SRS (Supplemental Restraint System) indicates that the airbags are designed to supplement seat belts, not replace them. Seat belts are the occupant's primary restraint system.

Housing Locations

The front airbags are housed in the center of the steering wheel for the driver, and in the dashboard for the front passenger. Both airbags are marked **SRS AIRBAG**.

Types of Airbags

The airbags can inflate whenever the power mode is in ON.

After an airbag inflates in a crash, you may see a small amount of smoke. This is from the combustion process of the inflator material and is not harmful. People with respiratory problems may experience some temporary discomfort. If this occurs, get out of the vehicle as soon as it is safe to do so.

Front Airbags (SRS)

During a frontal crash severe enough to cause one or both front airbags to deploy, the airbags can inflate at different rates, depending on the severity of the crash, whether or not the seat belts are latched, and/or other factors. Frontal airbags are designed to supplement the seat belts to help reduce the likelihood of head and chest injuries in frontal crashes.

■ Operation

Front airbags are designed to inflate during moderate-to-severe frontal collisions. When the vehicle decelerates suddenly, the sensors send information to the control unit which signals one or both front airbags to inflate.

A frontal collision can be either head-on or angled between two vehicles, or when a vehicle crashes into a stationary object, such as a concrete wall.

■ How the Front Airbags Work

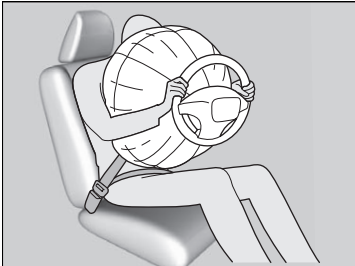

While your seat belt restrains your torso, the front airbag provides supplemental protection for your head and chest.

The front airbags deflate immediately so that they won't interfere with the driver's visibility or the ability to steer or operate other controls.

The total time for inflation and deflation is so fast that most occupants are not aware that the airbags deployed until they see them lying in front of them.

▶▶ How the Front Airbags Work

Although the driver's and front passenger's airbags normally inflate within a split second of each other, it is possible for only one airbag to deploy. This can happen if the severity of a collision is at the margin, or threshold that determines whether or not the airbags will deploy. In such cases, the seat belt will provide sufficient protection, and the supplemental protection offered by the airbag would be minimal.

■ When front airbags should not deploy

Minor frontal crashes: Front airbags were designed to supplement seat belts and help save lives, not to prevent minor scrapes, or even broken bones that might occur during a less than moderate-to-severe frontal crash.

Side impacts: Front airbags can provide protection when a sudden deceleration causes a driver or front passenger to move toward the front of the vehicle. Side airbags and side curtain airbags have been specifically designed to help reduce the severity of injuries that can occur during a moderate-to-severe side impact which can cause the driver or passenger to move toward the side of the vehicle.

Rear impacts: Head restraints and seat belts are your best protection during a rear impact. Front airbags cannot provide any significant protection and are not designed to deploy in such collisions.

Rollovers: In a rollover, your best form of protection is a seat belt or, if your vehicle is equipped with a rollover sensor, both a seat belt and a side curtain airbag. Front airbags, however, are not designed to deploy in a rollover as they would provide little if any protection.

■ When front airbags deploy with little or no visible damage

Because the airbag system senses sudden deceleration, a strong impact to the vehicle framework or suspension might cause one or more of the airbags to deploy. Examples include running into a curb, the edge of a hole, or other low fixed object that causes a sudden deceleration in the vehicle chassis. Since the impact is underneath the vehicle, damage may not be readily apparent.

■ When front airbags may not deploy, even though exterior damage appears severe

Since crushable body parts absorb crash energy during an impact, the amount of visible damage does not always indicate proper airbag operation. In fact, some collisions can result in severe damage but no airbag deployment because the airbags would not have been needed or would not have provided protection even if they had deployed.

Advanced Airbags

The airbags have advanced features to help reduce the likelihood of airbag related injuries to smaller occupants.

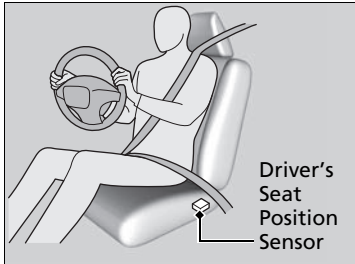

The driver's advanced airbag system includes a seat position sensor.

Based on information from this sensor and the severity of the impact, the advanced airbag system determines the optimal deployment of the driver's airbag.

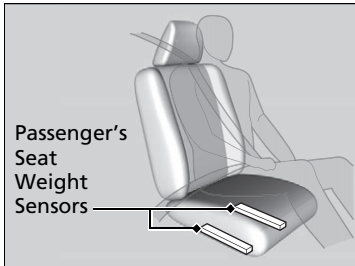

The front passenger's advanced airbag system has weight sensors.

We advise against allowing a child age 12 or under to ride in the front passenger's seat. However, **if you do allow a child age 12 or under to ride in the front passenger's seat**, note that the system will automatically turn off the front passenger's airbag if the sensors detect that the child is approximately 65 lbs (29 kg) or less.

Advanced Airbags

If there is a problem with the driver's seat position sensor, the SRS indicator will come on and the airbag will inflate with full (normal) force, regardless of the driver's seating position.

For the advanced airbags to work properly:

- Do not spill any liquid on or under the seats.
- Do not put any object under the passenger's seat.
- Make sure any objects are positioned properly on the floor. Improperly positioned objects can interfere with the advanced airbag sensors.
- All occupants should sit upright and wear their seat belts properly.
- Do not cover the passenger's side dashboard with a cloth, towel, cover, etc.

▶ **Passenger Airbag Off Indicator** P. 53

Make sure the floor mat behind the front passenger's seat is hooked to the floor mat anchor. An improperly placed mat can interfere with the advanced airbag sensors.

▶ **Floor Mats** P. 558

Side Airbags

The side airbags help protect the torso and pelvis of the driver or a front passenger during a moderate-to-severe side impact.

Housing Locations

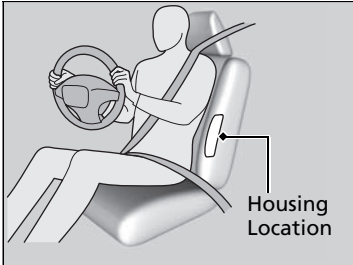

The side airbags are housed in the outside edge of the driver's and passenger's seat-backs.

Both are marked **SIDE AIRBAG**.

Operation

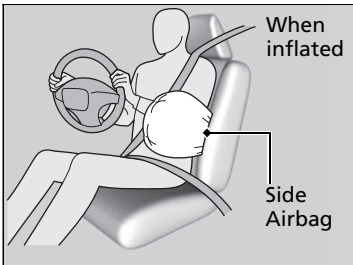

When the sensors detect a moderate-to-severe side impact, the control unit signals the side airbag on the impact side to immediately inflate.

Side Airbags

Make sure you and your front seat passenger always sit upright. Leaning into the path of a side airbag can prevent the airbag from deploying properly and increases your risk of serious injury.

Do not attach accessories on or near the side airbags. They can interfere with the proper operation of the airbags, or hurt someone if an airbag inflates.

Do not cover or replace the front seat-back covers without consulting a dealer. Improperly replacing or covering front seat-back covers can prevent your side airbags from properly deploying during a side impact.

■ **When a side airbag deploys with little or no visible damage**

Because the airbag system senses sudden acceleration, a strong impact to the side of the vehicle's framework can cause a side airbag to deploy. In such cases, there may be little or no damage, but the side impact sensors detected a severe enough impact to deploy the airbag.

■ **When a side airbag may not deploy, even though visible damage appears severe**

It is possible for a side airbag to not deploy during an impact that results in apparently severe damage. This can occur when the point of impact was toward the far front or rear of the vehicle, or when the vehicle's crushable body parts absorbed most of the crash energy. In either case, the side airbag would not have been needed nor provided protection even if it had deployed.

Side Curtain Airbags

The side curtain airbags help protect the heads of the driver and any passengers during a moderate-to-severe side impact. The side curtain airbags equipped in this vehicle are also designed to help reduce the likelihood of partial and complete ejection of vehicle occupants through side windows in crashes, particularly rollover crashes.

Housing Locations

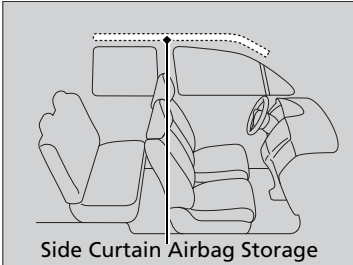

The side curtain airbags are located in the ceiling above the side windows on both sides of the vehicle.

Operation

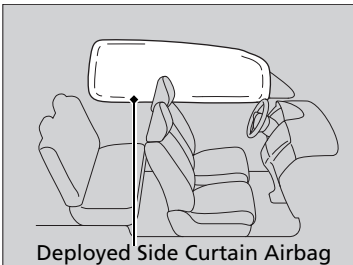

The side curtain airbag is designed to deploy in a rollover or a moderate-to-severe side impact.

Side Curtain Airbags

If the SRS control unit senses that your vehicle is about to rollover, it immediately deploys both side curtain airbags and activates both front seat belt tensioners.

If the impact is on the passenger's side, the passenger's side curtain airbag deploys even if there is no passenger in the passenger seat.

To get the best protection from the side curtain airbags, occupants should wear their seat belts properly and sit upright and well back in their seats.

Do not attach any objects to the side windows or roof pillars as they can interfere with the proper operation of the side curtain airbags.

■ When side curtain airbags deploy in a frontal collision

One or both side curtain airbags may also inflate in a moderate-to-severe angled frontal collision.

Airbag System Indicators

If a problem occurs in the airbag system, the SRS indicator will come on and a message appears on the multi-information display.

■ Supplemental Restraint System (SRS) Indicator

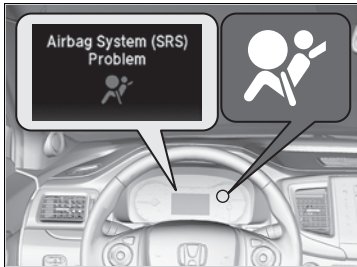

■ When the power mode is set to ON

The indicator comes on for a few seconds, then goes off. This tells you the system is working properly.

If the indicator comes on at any other time, or does not come on at all, have the system checked by a dealer as soon as possible. If you don't, your airbags and seat belt tensioners may not work properly when they are needed.

▶▶ Supplemental Restraint System (SRS) Indicator

⚠ WARNING

Ignoring the SRS indicator can result in serious injury or death if the airbag systems or tensioners do not work properly.

Have your vehicle checked by a dealer as soon as possible if the SRS indicator alerts you to a possible problem.

Passenger Airbag Off Indicator

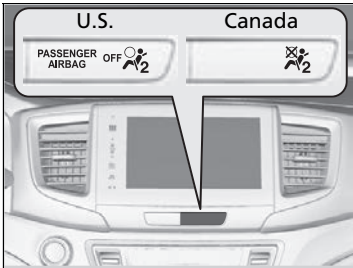

When the passenger airbag off indicator comes on

The indicator comes on to alert you that the passenger's front airbag has been turned off. This occurs when the weight sensors detect 65 lbs (29 kg) or less, the weight of an infant or small child, on the seat.

Children age 12 or under should always ride properly restrained in a back seat.

📖 **Child Safety** P. 55

Objects placed on the seat can also cause the indicator to come on.

If the front passenger seat is empty, the passenger's front airbag will not deploy and the indicator will not come on.

Passenger Airbag Off Indicator

If the indicator comes on with no front passenger and no objects on the passenger's seat, or with an adult riding there, something may be interfering with the weight sensors, such as:

- An object hanging on the seat or in the seat-back pocket.
- A child seat or other object pressing against the rear of the seat-back.
- A rear passenger pushing or pulling on the back of the front passenger's seat.
- The front seat or seat-back is forced back against an object on the seat or floor behind it.
- An object placed under the front passenger's seat.

If none of these conditions exist, have your vehicle checked by a dealer as soon as possible.

The passenger airbag off indicator may come on and goes off repeatedly if the total weight on the seat is near the airbag cutoff threshold.

Airbag Care

You do not need to, and should not, perform any maintenance on or replace any airbag system components yourself. However, you should have your vehicle inspected by a dealer in the following situations:

■ When the airbags have deployed

If an airbag has inflated, the control unit and other related parts must be replaced. Similarly, once an automatic seat belt tensioner has been activated, it must be replaced.

■ When the vehicle has been in a moderate-to-severe collision

Even if the airbags did not inflate, have your dealer inspect the following: the driver's seat position sensor, weight sensors in the passenger's seat, front seat belt tensioners, and each seat belt that was worn during the crash.

■ Do not remove or modify a front seat without consulting a dealer

This would likely disable or affect the proper operation of the driver's seat position sensor or the weight sensors in the passenger's seat. If it is necessary to remove or modify a front seat to accommodate a person with disabilities, contact a Honda dealer, or for U.S. vehicles, American Honda Automobile Customer Service at 1-800-999-1009 and for Canadian vehicles, Honda Canada Customer Relations at 1-888-9-HONDA-9.

▶▶ Airbag Care

We recommend against the use of salvaged airbag system components, including the airbag, tensioners, sensors, and control unit.

Protecting Child Passengers

Each year, many children are injured or killed in vehicle crashes because they are either unrestrained or not properly restrained. In fact, vehicle crashes are the number one cause of death of children ages 12 and under.

To reduce the number of child deaths and injuries, every state, Canadian province and territory requires that infants and children be properly restrained when they ride in a vehicle.

Children should sit properly restrained in a rear seat. This is because:

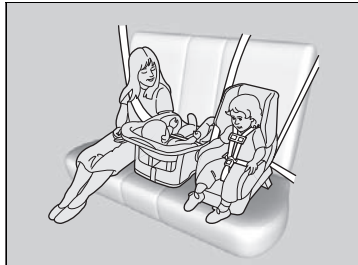

- An inflating front or side airbag can injure or kill a child sitting in the front seat.
- A child in the front seat is more likely to interfere with the driver's ability to safely control the vehicle.
- Statistics show that children of all sizes and ages are safer when they are properly restrained in a rear seat.

Protecting Child Passengers

⚠ WARNING

Children who are unrestrained or improperly restrained can be seriously injured or killed in a crash.

Any child too small for a seat belt should be properly restrained in a child seat. A larger child should be properly restrained with a seat belt, using a booster seat if necessary.

The National Highway Traffic Safety Administration and Transport Canada recommend that all children ages 12 and under be properly restrained in a rear seat. Some states or provinces/territories have laws restricting where children may ride.

Continued

- Any child who is too small to wear a seat belt correctly must be restrained in an approved child seat that is properly secured to the vehicle using either the seat belt or the lower anchors of the LATCH system.
- Never hold a child on your lap because it is impossible to protect them in the event of a collision.
- Never put a seat belt over yourself and a child. During a crash, the belt would likely press deep into the child and cause serious or fatal injuries.
- Never let two children use the same seat belt. Both children could be very seriously injured in a crash.
- Do not allow children to operate the doors, windows or seat adjustments.
- Do not leave children in the vehicle unattended, especially in hot weather when the inside of the vehicle can get hot enough to kill them. They could also activate vehicle controls causing it to move unexpectedly.

► Protecting Child Passengers

⚠ WARNING

Allowing a child to play with a seat belt or wrap one around their neck can result in serious injury or death.

Instruct children not to play with any seat belt and make sure any unused seat belt a child can reach is buckled, fully retracted, and locked.

⚠ WARNING

Allowing a child to play on the pickup bed can result in serious injury or death by opening or closing the tailgate.

To deactivate a lockable retractor, release the buckle and allow the seat belt to wind up all the way.

To remind you of the passenger's front airbag hazards and child safety, your vehicle warning came with a label on the dashboard (U.S. models) and has labels on the front visors. Please read and follow the instructions on these labels.

📖 Safety Labels P. 71

Safety of Infants and Small Children

■ Protecting Infants

An infant must be properly restrained in a rear-facing, reclining child seat until the infant reaches the seat manufacturer's weight or height limit for the seat, and the infant is at least one year old. Many experts recommend use of a rear-facing seat for a child up to two years old if the child's height and weight are appropriate for a rear-facing seat.

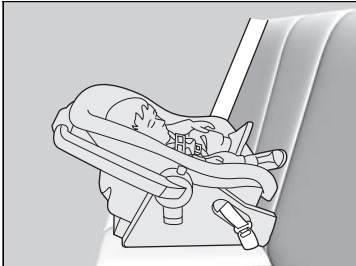

■ Positioning a rear-facing child seat

Child seats must be placed and secured in a rear seating position.

When properly installed, a rear-facing child seat may prevent the driver or a front passenger from moving their seat all the way back, or from locking their seat-back in the desired position. Make sure that there is no contact between the child seat and the seat in front of it.

It can also interfere with proper operation of the passenger's advanced front airbag system.

➤ **Airbags** P. 42

If this occurs, we recommend that you install the child seat directly behind the front passenger's seat, move the seat as far forward as needed, and leave it unoccupied. Or, you may wish to get a smaller rear-facing child seat.

⊠ Protecting Infants

⚠ WARNING

Placing a rear-facing child seat in the front seat can result in serious injury or death during a crash.

Always place a rear-facing child seat in the rear seat, not the front.

Rear-facing child seats should never be installed in a forward facing position.

Always refer to the child seat manufacturer's instructions before installation.

Do not allow a front seat to rest against a child seat installed in a rear seating position: The weight sensor in the front seat may not correctly detect the actual weight of the occupant.

■ Protecting Smaller Children

If a child is at least one year old and has exceeded the weight and height limitations of a rearward facing child seat, the child should be properly restrained in a firmly secured forward facing child seat until they exceed the weight and height limitations for the forward facing child seat.



■ Forward-facing child seat placement

We strongly recommend placing a forward-facing child seat in a rear seating position.

Placing a forward-facing child seat in the front seat can be hazardous, even with advanced front airbags that automatically turn the passenger's front airbag off. A rear seat is the safest place for a child.

▶▶ Protecting Smaller Children

⚠ WARNING

Placing a forward-facing child seat in the front seat can result in serious injury or death if the front airbag inflates.

If you must place a forward-facing child seat in front, move the vehicle seat as far back as possible, and properly restrain the child.

Educate yourself about the laws and regulations regarding child seat use where you are driving, and follow the child seat manufacturer's instructions.

Many experts recommend use of a rear-facing seat for a child up to two years old if the child's height and weight are appropriate for a rear-facing seat.

■ Selecting a Child Seat

Most child seats are LATCH-compatible (Lower Anchors and Tethers for Children). Some have a rigid-type connector while others have a flexible-type connector. Both are equally easy to use. Some existing and previously owned child seats can only be installed using the seat belt. Whichever type you choose, follow the child seat manufacturer's use and care instructions including recommended expiration dates as well as the instructions in this manual. Proper installation is key to maximizing your child's safety.

In seating positions and vehicles not equipped with LATCH, a LATCH compatible child seat can be installed using the seat belt and a top tether for added security. This is because all child seats are required to be designed so that they can be secured with a lap belt or the lap part of a lap/shoulder belt. In addition, the child seat manufacturer may advise that a seat belt be used to attach a LATCH-compatible seat once a child reaches a specified weight. Please read the child seat owner's manual for proper installation instructions.

■ Important consideration when selecting a child seat

Make sure the child seat meets the following three requirements:

- The child seat is the correct type and size for the child.
- The child seat is the correct type for the seating position.
- The child seat is compliant with Federal Motor Vehicle Safety Standard 213 or Canadian Motor Vehicle Safety Standard 213.

▶▶ Selecting a Child Seat

Installation of a LATCH-compatible child seat is simple.

LATCH-compatible child seats have been developed to simplify the installation process and reduce the likelihood of injuries caused by incorrect installation.

■ Installing a LATCH-Compatible Child Seat

A LATCH-compatible child seat can be installed in any of the three rear seating position. A child seat is attached to the lower anchors with either the flexible or rigid type of connectors.

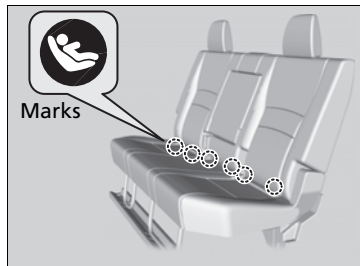

1. Locate the lower anchors under the marks.
2. Make sure there are no objects near the anchors that could prevent a secure connection between the child seat and the anchors.

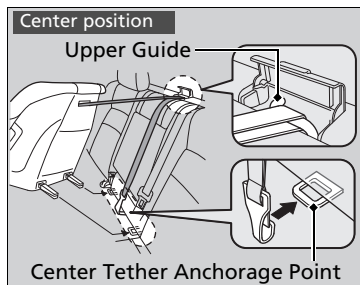

3. Lower the head restraint to its lowest position.
4. Lift the upper guide cover, then route the tether strap around the upper guide.
5. Route the tether strap downward properly, then attach the strap hook to the center tether anchor.
 - Making sure the strap is not twisted.

►► Installing a LATCH-Compatible Child Seat

⚠ WARNING

Never attach two child seats to the same anchor. In a collision, one anchor may not be strong enough to hold two child seat attachments and may break, causing serious injury or death.

For your child's safety, when using a child seat installed using the LATCH system, make sure that the child seat is properly secured to the vehicle. A child seat that is not properly secured will not adequately protect a child in a crash and may cause injury to the child or other vehicle occupants.

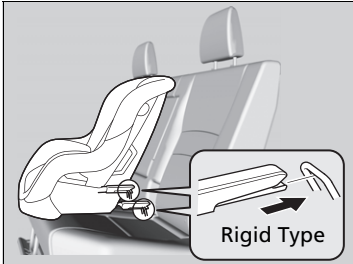
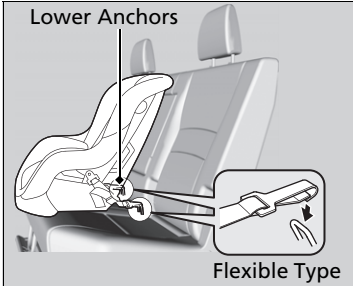

All positions

- Place the child seat on the vehicle seat, then attach the child seat to the lower anchors according to the instructions that came with the child seat.

▶▶ Installing a LATCH-Compatible Child Seat

⚠ WARNING

Do not use the lower inner anchors of the outer rear seats to secure a LATCH-compatible child seat to the rear center seat, unless the manufacturer's instructions for that system permit the use of inner anchors with the stated spacing.

Installing a LATCH-compatible child seat in the rear center seat

Each outer rear seat is equipped with a pair of lower anchors which are used to secure a LATCH-compatible child seat. The rear center seat, however, is not equipped with anchors of any kind. The inner and outer anchors are spaced apart at a standard distance of 11 inches (280 mm). The distance between the two inner anchors is 21.7 inches (550 mm).

LATCH-compatible restraint systems that are fitted with rigid-type attachments cannot be installed in the rear center seat. However, a system fitted with flexible-type attachments can be installed in the center seat, provided that the manufacturer's instructions for that system permit the use of the inner anchors with the stated spacing.

Before seating a child, make sure that the system is properly attached to both the lower anchors and tether anchors.

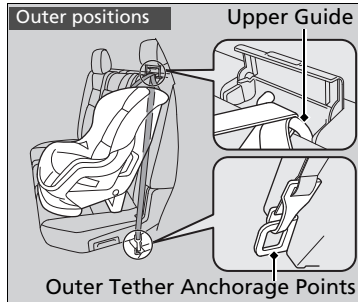
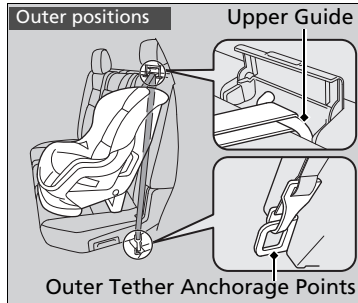

Outer positions

7. Put the outer head restraint to its uppermost position (or remove it), then route the tether strap over the seat-back and through the head restraint legs.
8. Lift the upper guide cover, then route the tether strap around the upper guide.
9. Route the tether strap downward properly, then attach the strap hook to the tether anchor under the seat. See the label.
 - Making sure the strap is not twisted.

All positions

10. Tighten the tether strap as instructed by the child seat manufacturer.
11. Make sure the child seat is firmly secured by rocking it forward and back and side to side; little movement should be felt.
12. Make sure any unused seat belt that a child can reach is buckled, the lockable retractor is activated, and the belt is fully retracted and locked.

► **Protecting Child Passengers** P. 55

■ Installing a Child Seat with a Lap/Shoulder Seat Belt

A child seat can be installed with a lap/shoulder belt in any rear seat or, if absolutely necessary, the front passenger seat.



1. Place the child seat on the vehicle seat.
2. Route the seat belt through the child seat according to the seat manufacturer's instructions, and insert the latch plate into the buckle.
 - ▶ Insert the latch plate fully until it clicks.

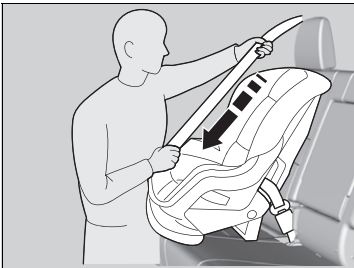

3. Slowly pull the shoulder part of the belt all the way out until it stops. This activates the lockable retractor.
4. Let the seat belt retract a few inches and check that the retractor has switched modes by pulling on the webbing. It should not pull out again until it is reset by removing the latch plate from the buckle.
 - ▶ If you are able to pull the shoulder belt out, the lockable retractor is not activated. Slowly pull the seat belt all the way out, and repeat steps 3 – 4.

⊠ Installing a Child Seat with a Lap/Shoulder Seat Belt

A child seat that is not properly secured will not adequately protect a child in a crash and may cause injury to the child or other vehicle occupants.



5. Grab the shoulder part of the seat belt near the buckle, and pull up to remove any slack from the lap part of the belt.

▶ When doing this, place your weight on the child seat and push it into the vehicle seat.

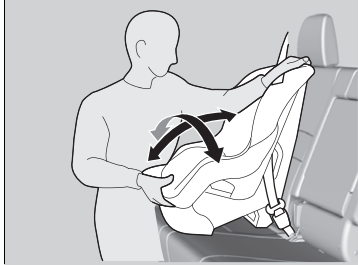

6. Make sure the child seat is firmly secured by rocking it forward and back and side to side; less than one inch of movement should occur near the seat belt.

7. Make sure any unused seat belt that a child can reach is buckled, the lockable retractor is activated, and the belt is fully retracted and locked.

➤ **Protecting Child Passengers** P. 55

➤ **Installing a Child Seat with a Lap/Shoulder Seat Belt**

To deactivate a lockable retractor, release the buckle and allow the seat belt to wind up all the way.

■ Adding Security with a Tether

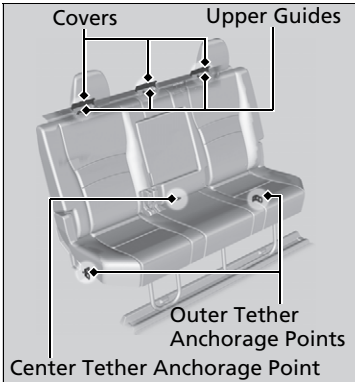

A tether anchorage point is provided at each outside of the seat bottom and between the lower anchors of the rear center seat. If you have a child restraint system that comes with a tether but can be installed with a seat belt, the tether may be used for additional security.

▣ Adding Security with a Tether

Since a tether can provide additional security to the lap/shoulder seat belt installation, we recommend using a tether whenever one is available.

Always use a tether for forward facing child seats when using the seat belt or lower anchors.

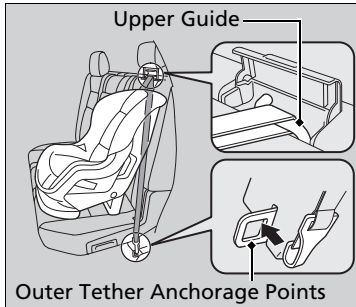

■ Using an outer anchor

1. Put the outer head restraint to its uppermost position, then route the tether strap between the head restraint legs.
2. Lift the cover, then hook the tether strap through the upper guide as shown.
3. Route the tether strap downward properly, making sure the strap is not twisted.
4. Attach the tether strap hook to the outer tether anchor on the outside of the seat bottom.
5. Tighten the tether strap as instructed by the child seat manufacturer.

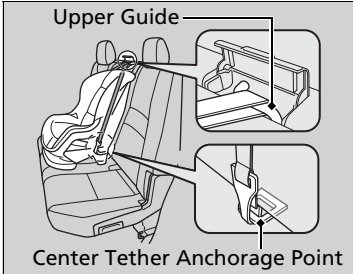

■ Using the center anchor

1. Lower the head restraint to its lowest position.
2. Route the tether strap over the seat-back, lift the cover, then hook the tether strap through the upper guide as shown.
3. Route the tether strap downward properly along the seat-back, making sure the strap is not twisted.
4. Attach the tether strap hook to the center tether anchor between the lower anchors for the LATCH-compatible child seat.
5. Tighten the tether strap as instructed by the child seat manufacturer.

☒ Using the center anchor

Make sure to attach the tether strap hook to the anchor before installing the child seat, because the tether anchor is positioned behind the child seat.

Safety of Larger Children

Protecting Larger Children

The following pages give instructions on how to check proper seat belt fit, what kind of booster seat to use if one is needed, and important precautions for a child who must sit in front.

Checking Seat Belt Fit

When a child is too big for a child seat, secure the child in a rear seat using the lap/shoulder seat belt. Have the child sit upright and all the way back, then answer the following questions.



Checklist

- Do the child's knees bend comfortably over the edge of the seat?
- Does the shoulder belt cross between the child's neck and arm?
- Is the lap part of the seat belt as low as possible, touching the child's thighs?
- Will the child be able to stay seated like this for the whole trip?

If you answer yes to all these questions, the child is ready to wear the lap/shoulder seat belt correctly. If you answer no to any question, the child needs to ride on a booster seat until the seat belt fits properly without a booster seat.

Safety of Larger Children

WARNING

Allowing a child age 12 or under to sit in front can result in injury or death if the passenger's front airbag inflates.

If a larger child must ride in front, move the vehicle seat as far to the rear as possible, have the child sit up properly and wear the seat belt properly, using a booster seat if needed.

Booster Seats



If a lap/shoulder seat belt cannot be used properly, position the child in a booster seat in a rear seat. For the child's safety, check that the child meets the booster seat manufacturer's recommendations.

Protecting Larger Children-Final Checks

Your vehicle has a rear seat where children can be properly restrained. If you ever have to carry a group of children, and a child must ride in front:

- Make sure you read and fully understand the instructions and safety information in this manual.
- Move the front passenger seat as far back as possible.
- Have the child sit upright and well back in the seat.
- Check that the seat belt is properly positioned so that the child is secure in the seat.

Monitoring child passengers

We strongly recommend that you keep an eye on child passengers. Even older, more mature children sometimes need to be reminded to fasten their seat belts and sit up properly.

Booster Seats

When installing a booster seat, make sure to read the instructions that came with it, and install the seat accordingly.

There are high- and low-type booster seats. Choose a booster seat that allows the child to wear the seat belt correctly.

Some U.S. states, and Canadian provinces and territories require children to use a booster seat until they reach a given age or weight (e.g. six years or 60 lbs). Be sure to check current laws in the state or province, or territory where you intend to drive.

Carbon Monoxide Gas

The engine exhaust from this vehicle contains carbon monoxide, a colorless, odorless, and highly toxic gas. As long as you properly maintain your vehicle, carbon monoxide gas will not get into the interior.

■ Have the exhaust system inspected for leaks whenever

- The exhaust system is making an unusual noise.
- The exhaust system may have been damaged.
- The vehicle is raised for an oil change.

ⓘ Carbon Monoxide Gas

WARNING

Carbon monoxide gas is toxic.

Breathing it can cause unconsciousness and even kill you.

Avoid any enclosed areas or activities that expose you to carbon monoxide.

An enclosed area such as a garage can quickly fill up with carbon monoxide gas. Do not run the engine with the garage door closed. Even when the garage door is open, drive out of the garage immediately after starting the engine.

Label Locations

These labels are in the locations shown. They warn you of potential hazards that can cause serious injury or death. Read these labels carefully.

If a label comes off or becomes hard to read (except for the U.S. dashboard label which may be removed by the owner), contact a dealer for a replacement.

Sun Visor
U.S. models

▲ WARNING

EVEN WITH ADVANCED AIR BAGS

- Child can be killed or seriously injured by the air bag.
- The back seat is the safest place for children.
- Never use a rear-facing child seat in the front.
- Always use seat belts and child restraints.
- See owner's manual for more information about air bags.

Canadian models

▲ WARNING	▲ ATTENTION
<p>To avoid serious injury</p> <ul style="list-style-type: none"> ■ For maximum safety protection in all types of crashes, you must always wear your safety belt. ■ Do not install rearward-facing child seats in any front passenger seat position. ■ Do not sit or lean unnecessarily close to the air bag. ■ Do not place any objects over the air bag or between the air bag and yourself. ■ See the owner's manual for further information and explanations. 	<p>Pour éviter des blessures graves</p> <ul style="list-style-type: none"> ■ Pour profiter d'une protection maximale lors d'une collision bouclez toujours votre ceinture de sécurité. ■ N'installez jamais un siège pour enfants faisant face à l'arrière sur le siège du passager avant. ■ Ne vous appuyez pas et ne vous assoyez pas près du coussin gonflable. ■ Ne déposez aucun objet sur le coussin gonflable ou entre le coussin gonflable et vous. ■ Lisez le guide utilisateur pour de plus amples renseignements.

Sun Visor
U.S. models only

▲ WARNING: HIGHER ROLLOVER RISK

Avoid Abrupt Maneuvers and Excessive Speed.
Always Buckle Up.
See Owner's Manual For Further Information.

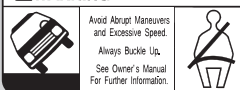

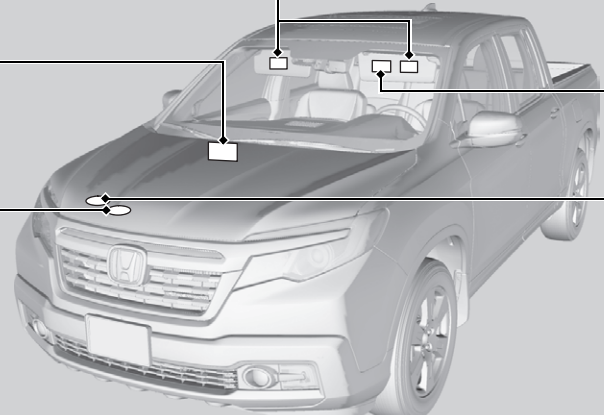

Dashboard
U.S. models only

This Vehicle is Equipped with Advanced Air Bags

Even with Advanced Air Bags

Children can be killed or seriously injured by the air bags. The back seat is the safest place for children. Never use a rear-facing child seat in the front. Always use seat belts and child restraints. See owner's manual for more information about air bags.

to be removed by owner only.

Air Conditioner System
U.S. models

▲ WARNING

Flammable Refrigerant
CAUTION: SYSTEM CONTAINS REFRIGERANT
BECAUSE OF HIGH PRESSURE.
TO BE SERVICED ONLY BY QUALIFIED PERSONNEL.
See instructions in the service manual.

AIR CONDITIONER SYSTEM
REFRIGERANT: R-1234yf (SAE J681 (D64) (D65))
REC. CHARGE: MAX 0.825kg MIN 0.575kg
OIL TYPE: RLB5M OIL (POE)

TBZ Honda Motor Co., Ltd.

Canadian models



R-1234yf

Radiator Cap

▲ DANGER
WARNING
危険 危険

NEVER OPEN WHEN HOT.
HOT coolant will scald you.
N'OUVEREZ PAS QUAND CHAUD.
N'EST BEUSSEZ MOTOR OFFREIL.
熱い液体があなたを火傷させます。
108kPa



U.S. models

⚠ WARNING

- Do not fill a portable fuel container in the truck bed.
- Static electricity can ignite gas vapors and you can be burned.
- Always place container on the ground before filling.
- See owner's manual for complete instructions.

Canadian models

⚠ WARNING

- Do not fill a portable fuel container in the truck bed.
- Static electricity can ignite gas vapors and you can be burned.
- Always place container on the ground before filling.
- See owner's manual for complete instructions.

⚠ ATTENTION

- Ne pas remplir un bidon d'essence dans l'espace cargo.
- L'électricité statique peut enflammer les vapeurs d'essence et vous brûler.
- Toujours déposer le bidon d'essence au sol avant le remplissage.
- Pour de plus amples renseignements consulter le manuel du propriétaire.









Pickup bed





Instrument Panel

This chapter describes the buttons, indicators, and gauges that are used while driving.

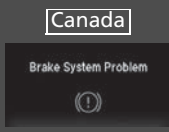

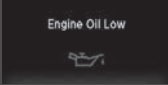













Indicators	74
Multi-Information Display Warning and Information Messages.....	91
Gauges and Multi-Information Display	
Gauges.....	103
Multi-Information Display	104

Indicator	Name	On/Blinking	Explanation	Message
 <p>U.S. BRAKE Canada  (Red)</p>	Parking Brake and Brake System Indicator (Red)	<ul style="list-style-type: none"> Comes on for a few seconds when you set the power mode to ON, then goes off if the parking brake has been released. Comes on when the parking brake is applied, and goes off when it is released. Comes on when the brake fluid level is low. Comes on if there is a problem with the brake system. The beeper sounds and the indicator comes on if you drive with the parking brake not fully released. 	<ul style="list-style-type: none"> Comes on while driving - Make sure the parking brake is released. Check the brake fluid level. <ul style="list-style-type: none"> ➤ What to do when the indicator comes on while driving P. 587 Comes on along with the ABS indicator - Have your vehicle checked by a dealer. <ul style="list-style-type: none"> ➤ If the Brake System Indicator (Red) Comes On P. 587 	  
 <p>U.S. BRAKE SYSTEM Canada  (Amber)</p>	Brake System Indicator (Amber)	<ul style="list-style-type: none"> Comes on for a few seconds when you set the power mode to ON, then goes off. Comes on if there is a problem with a system related to braking other than the conventional brake system. 	<ul style="list-style-type: none"> Comes on while driving - Have your vehicle checked by a dealer. With this indicator on, your vehicle still has normal braking ability. 	 





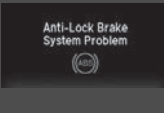

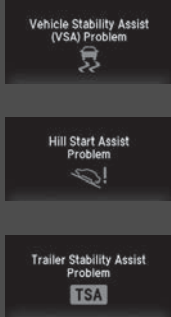

Indicator	Name	On/Blinking	Explanation	Message
	Low Oil Pressure Indicator	<ul style="list-style-type: none"> • Comes on when you set the power mode to ON, and goes off when the engine starts. • Comes on when the engine oil pressure is low. 	<ul style="list-style-type: none"> • Comes on while driving - Immediately stop in a safe place. <ul style="list-style-type: none"> ► If the Low Oil Pressure Indicator Comes On P. 585 	
	Malfunction Indicator Lamp	<ul style="list-style-type: none"> • Comes on when you set the power mode to ON, and goes off either when the engine starts or after several seconds if the engine did not start. If "readiness codes" have not been set, it blinks five times before it goes off. • Comes on if there is a problem with the emissions control systems. • Blinks when a misfire in the engine's cylinders is detected. 	<ul style="list-style-type: none"> • Readiness codes are part of the on board diagnostics for the emissions control systems. <ul style="list-style-type: none"> ► Testing of Readiness Codes P. 605 • Comes on while driving - Have your vehicle checked by a dealer. • Blinks while driving - Stop in a safe place where there are no flammable objects. Stop the engine for 10 minutes or more, and wait for it to cool down. Then, take your vehicle to a dealer. <ul style="list-style-type: none"> ► If the Malfunction Indicator Lamp Comes On or Blinks P. 586 	
	Charging System Indicator	<ul style="list-style-type: none"> • Comes on when you set the power mode to ON, and goes off when the engine starts. • Comes on when the battery is not charging. 	<ul style="list-style-type: none"> • Comes on while driving - Turn off the climate control system*/heating and cooling system* and rear defogger in order to reduce electricity consumption. <ul style="list-style-type: none"> ► If the Charging System Indicator Comes On P. 585 	







* Not available on all models



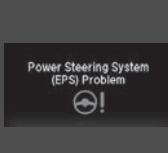

Indicator	Name	On/Blinking	Explanation	Message
	Shift Lever Position Indicator	<ul style="list-style-type: none"> Indicates the current shift lever position. 	<p> Shifting P. 440</p>	—
	Transmission Indicator	<ul style="list-style-type: none"> Blinks if the transmission system has a problem. 	<ul style="list-style-type: none"> Blinks while driving - Avoid sudden starts and acceleration and have the vehicle checked by a dealer immediately. 	<p>Transmission System Problem</p> 
	Seat Belt Reminder Indicator	<ul style="list-style-type: none"> Comes on and the beeper sounds if you are not wearing a seat belt when you set the power mode to ON. If the front passenger is not wearing a seat belt, the indicator comes on about a few seconds later. Blinks while driving if either you or the front passenger has not fastened a seat belt. The beeper sounds and the indicator blinks at regular intervals. 	<ul style="list-style-type: none"> The beeper stops and the indicator goes off when you and the front passenger fasten their seat belts. Stays on after you or the front passenger has fastened the seat belt - A detection error may have occurred in the sensor. Have your vehicle checked by a dealer. <p> Seat Belt Reminder P. 36</p>	<p>Fasten Seat Belt</p>  <p>Fasten Passenger's Seat Belt</p> 

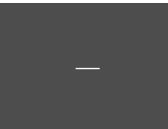
Indicator	Name	On/Blinking	Explanation	Message
	Low Fuel Indicator	<ul style="list-style-type: none"> • Comes on when the fuel reserve is running low (approximately 2.5 U.S. gal./9.5 Liter left). • Blinks if there is a problem with the fuel gauge. 	<ul style="list-style-type: none"> • Comes on - Refuel your vehicle as soon as possible. • Blinks - Have your vehicle checked by a dealer. 	 
	Anti-lock Brake System (ABS) Indicator	<ul style="list-style-type: none"> • Comes on for a few seconds when you set the power mode to ON, then goes off. • If it comes on at any other time, there is a problem with the ABS. 	<ul style="list-style-type: none"> • Stays on constantly - Have your vehicle checked by a dealer. With this indicator on, your vehicle still has normal braking ability but no anti-lock function.  Anti-lock Brake System (ABS) P. 490 	
	Supplemental Restraint System Indicator	<ul style="list-style-type: none"> • Comes on for a few seconds when you set the power mode to ON, then goes off. • Comes on if a problem with any of the following is detected: <ul style="list-style-type: none"> - Supplemental restraint system - Side airbag system - Side curtain airbag system - Seat belt tensioner 	<ul style="list-style-type: none"> • Stays on constantly or does not come on at all - Have your vehicle checked by a dealer. 	

Indicator	Name	On/Blinking	Explanation	Message
	<p>Vehicle Stability Assist (VSA®) System Indicator</p>	<ul style="list-style-type: none"> • Comes on for a few seconds when you set the power mode to ON, then goes off. • Blinks when VSA®, or trailer stability assist is active. • Comes on if there is a problem with the VSA®, hill start assist, trailer stability assist or brake lighting system. 	<ul style="list-style-type: none"> • Stays on constantly - Have your vehicle checked by a dealer. <ul style="list-style-type: none"> ➤ Vehicle Stability Assist (VSA®), aka Electronic Stability Control (ESC), System P. 476 ➤ Trailer Stability Assist P. 427 ➤ Hill start assist system P. 437 • When Trailer Stability Assist Problem is displayed on the multi-information display, the VSA® does not activate. 	









Indicator	Name	On/Blinking	Explanation	Message
	Vehicle Stability Assist (VSA®) OFF Indicator	<ul style="list-style-type: none"> • Comes on for a few seconds when you set the power mode to ON, then goes off. 	—	—
		<ul style="list-style-type: none"> • Comes on when VSA® OFF switch is pressed. 	<ul style="list-style-type: none"> • Appears when Normal or Snow Mode is selected.  VSA® On and Off P. 477 	
		<p>AWD models</p> <ul style="list-style-type: none"> • Comes on when Mud/Sand mode is selected by pressing Intelligent Traction Management System switch. 	<ul style="list-style-type: none"> • Appears when Mud Mode is selected.  Intelligent Traction Management P. 443 	
			<ul style="list-style-type: none"> • Appears when Sand Mode is selected.  Intelligent Traction Management P. 443 	
			<ul style="list-style-type: none"> • Appears when Mud or Sand Mode is selected. To turn VSA® on, select Normal or Snow.  Intelligent Traction Management P. 443 	

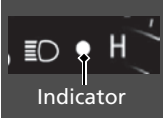



Indicator	Name	On/Blinking	Explanation	Message
	Electric Power Steering (EPS) System Indicator	<ul style="list-style-type: none"> Comes on when you set the power mode to ON, and goes off when the engine starts. Comes on if there is a problem with the EPS system. 	<ul style="list-style-type: none"> Stays on constantly or does not come on at all - Have your vehicle checked by a dealer. <ul style="list-style-type: none"> ➤ If the Electric Power Steering (EPS) System Indicator Comes On P. 587 	
	Low Tire Pressure/TPMS Indicator	<ul style="list-style-type: none"> Comes on for a few seconds when you set the power mode to ON, then goes off. Comes on if the tire pressure of any of the tires becomes significantly low. Blinks for about one minute, and then stays on if there is a problem with the TPMS with Tire Fill Assist, or when a compact spare tire is temporarily installed. 	<ul style="list-style-type: none"> Comes on while driving - Stop in a safe place, check tire pressures, and inflate the tire(s) if necessary. Blinks and remains on - Have your vehicle checked by a dealer. If the vehicle is fitted with a compact spare, get your regular tire repaired or replaced and put back on your vehicle as soon as you can. 	 
	Turn Signal and Hazard Warning Indicators	<ul style="list-style-type: none"> Blinks when you operate the turn signal lever. Blink when you press the hazard warning button. 	<ul style="list-style-type: none"> Does not blink or blinks rapidly - A turn signal light bulb has blown. Change the bulb immediately. <ul style="list-style-type: none"> ➤ Replacing Light Bulbs P. 540, 541 	
	High Beam Indicator	<ul style="list-style-type: none"> Comes on when the high beam headlights are on. 	—	

Indicator	Name	On/Blinking	Explanation	Message
	Lights On Indicator	<ul style="list-style-type: none"> Comes on whenever the light switch is on, or in AUTO when the exterior lights are on. 	<ul style="list-style-type: none"> If you set the power mode to VEHICLE OFF (LOCK) while the lights are on, a chime sounds when the driver's door is opened. 	—
	Auto high-beam Indicator*	<ul style="list-style-type: none"> Comes on for a few seconds when you set the power mode to ON, then goes off. Comes on when all the operating conditions of the Auto high-beam are met. 	<p> Auto High-Beam (High Beam Support System)* P. 151</p>	—
	Fog Light Indicator*	<ul style="list-style-type: none"> Comes on when the fog lights are on. 	—	—
	Immobilizer System Indicator	<ul style="list-style-type: none"> Comes on briefly when you set the power mode to ON, then goes off. Comes on if the immobilizer system cannot recognize the key information. 	<ul style="list-style-type: none"> Blinks - You cannot start the engine. Set the power mode to VEHICLE OFF (LOCK), then select the ON mode again. Repeatedly blinks - The system may be malfunctioning. Have your vehicle checked by a dealer. Do not attempt to alter this system or add other devices to it. Electrical problems can occur. 	—



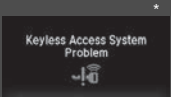
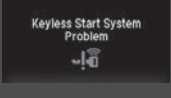

Instrument Panel



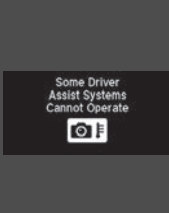

* Not available on all models

Indicator	Name	On/Blinking	Explanation	Message
	Security System Alarm Indicator	<ul style="list-style-type: none"> Blinks when the security system alarm has been set. 	<p> Security System Alarm P. 133</p>	—
	System Message Indicator	<ul style="list-style-type: none"> Comes on for a few seconds when you set the power mode to ON, then goes off. Comes on along with a beep when a problem is detected. A system message on the multi-information display appears at the same time. 	<ul style="list-style-type: none"> While the indicator is on, press the  (information) button to see the message again. Refer to the Indicators information in this chapter when a system message appears on the multi-information display. Take the appropriate action for the message. The multi-information display does not return to the normal screen unless the warning is canceled, or the  button is pressed. 	—
	CRUISE MAIN Indicator*	<ul style="list-style-type: none"> Comes on when you press the CRUISE button. 	<p> Cruise Control* P. 445</p>	—
	CRUISE CONTROL Indicator*	<ul style="list-style-type: none"> Comes on when you have set a speed for cruise control. 	<p> Cruise Control* P. 445</p>	—

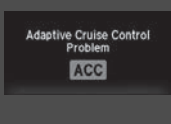

Indicator	Name	On/Blinking	Explanation	Message
	Smart Entry System Indicator	<ul style="list-style-type: none"> • Comes on for a few seconds when you set the power mode to ON, then goes off. • Comes on as soon as a problem is detected in the smart entry system* or keyless starting system. 	<ul style="list-style-type: none"> • Have your vehicle checked by a dealer. 	
				
	All-wheel drive (AWD) Indicator*	<ul style="list-style-type: none"> • Comes on for a few seconds when you set the power mode to ON, then goes off. • Comes on if there is a problem with the AWD system. • Blinks when the differential temperature is too high. 	<ul style="list-style-type: none"> • Stays on constantly - The engine drives the front wheels only in this state. Have your vehicle checked by a dealer. 	
			<ul style="list-style-type: none"> • Blinks while driving - Stop in a safe place, change to P, and idle the engine until the indicator goes off. If the indicator does not stop blinking, take your vehicle to a dealer.  i-VTM4 (Intelligent Variable Torque Management)-4® System* P. 479 	







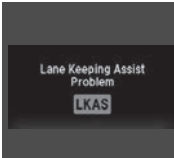

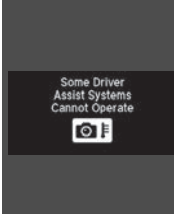
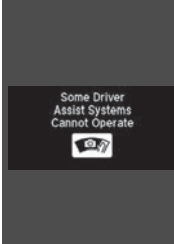
* Not available on all models

Indicator	Name	On/Blinking	Explanation	Message
	Road Departure Mitigation (RDM) Indicator*	<ul style="list-style-type: none"> • Comes on for a few seconds when you set the power mode to ON, then goes off. • Comes on if there is a problem with the RDM system. 	<ul style="list-style-type: none"> • Stays on constantly - Have your vehicle checked by a dealer. 	
		<ul style="list-style-type: none"> • Comes on when the RDM system shuts itself off. 	<ul style="list-style-type: none"> • Stays on - The temperature inside the camera is too high. Use the climate control system*/heating and cooling system* to cool down the camera. The system activates when the temperature inside the camera cools down. ► Front Sensor Camera* P. 448 	
			<ul style="list-style-type: none"> • Stays on - The area around the camera is blocked by dirt, mud, etc. Stop your vehicle in a safe place, and wipe it off with a soft cloth. • Have your vehicle checked by a dealer if the indicator and message come back on after you cleaned the area around the camera. ► Front Sensor Camera* P. 448 	

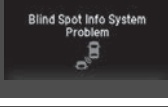

Indicator	Name	On/Blinking	Explanation	Message
<p style="font-size: 2em; font-weight: bold; text-align: center;">ACC</p>	<p>Adaptive Cruise Control (ACC) Indicator (Amber)*</p>	<ul style="list-style-type: none"> • Comes on for a few seconds when you set the power mode to ON, then goes off. • Comes on if there is a problem with ACC. 	<ul style="list-style-type: none"> • Comes on while driving - Have your vehicle checked by a dealer. 	
		<ul style="list-style-type: none"> • Comes on if anything covers the radar sensor cover and prevents the sensor from detecting a vehicle in front. • May come on when driving in bad weather (rain, snow, fog, etc.) • ACC has been automatically canceled. 	<ul style="list-style-type: none"> • When the radar sensor gets dirty, stop your vehicle in a safe place, and wipe off dirt using a soft cloth. • Have your vehicle checked by a dealer if the message does not disappear even after you clean the sensor cover. 	
<p style="font-size: 2em; font-weight: bold; text-align: center;">ACC</p>	<p>Adaptive Cruise Control (ACC) Indicator (Green)*</p>	<ul style="list-style-type: none"> • Comes on when you press the MAIN button. 	<p>➤ Adaptive Cruise Control (ACC)* P. 455</p>	
		<ul style="list-style-type: none"> • Comes on if the temperature inside the camera is too high. • ACC has been automatically canceled. 	<ul style="list-style-type: none"> • Use the climate control system*/heating and cooling system* to cool down the camera. • Goes off - The camera has been cooled down. Pressing the MAIN button can resume the system. <p>➤ Front Sensor Camera* P. 448 ➤ Adaptive Cruise Control (ACC)* P. 455</p>	





* Not available on all models

Indicator	Name	On/Blinking	Explanation	Message
LKAS	Lane Keeping Assist System (LKAS) Indicator (Amber)*	<ul style="list-style-type: none"> Comes on for a few seconds when you set the power mode to ON, then goes off. Comes on if there is a problem with the LKAS. 	<ul style="list-style-type: none"> Stays on constantly - Have your vehicle checked by a dealer. 	
LKAS	Lane Keeping Assist System (LKAS) Indicator (Green)*	<ul style="list-style-type: none"> Comes on when you press the MAIN button. 	<ul style="list-style-type: none"> ➤ Lane Keeping Assist System (LKAS)* P. 468 	
		<ul style="list-style-type: none"> Comes on when the LKAS is in operation, or the LKAS button is pressed, but the temperature inside the front sensor camera is too high. The LKAS cancels automatically. The beeper sounds simultaneously. 	<ul style="list-style-type: none"> Use the climate control system*/heating and cooling system* to cool down the camera. Goes off - The camera has been cooled down and the system activates normally. ➤ Front Sensor Camera* P. 448 	
		<ul style="list-style-type: none"> Comes on when the area around the camera is blocked by dirt, mud, etc. Stop your vehicle in a safe place, and wipe it off with a soft cloth. May come on when driving in bad weather (rain, snow, fog, etc.) 	<ul style="list-style-type: none"> Have your vehicle checked by a dealer if the indicator and message come back on after you cleaned the area around the camera. 	

Indicator	Name	On/Blinking	Explanation	Message
	Blind spot information (BSI) Indicator*	<ul style="list-style-type: none"> Comes on for a few seconds when you set the power mode to ON, then goes off. Stays on while BSI is turned off. 	—	
		<ul style="list-style-type: none"> Comes on when mud, snow, or ice accumulates in the vicinity of sensor. 	<ul style="list-style-type: none"> Comes on while driving - Remove the obstacle in the vicinity of sensor.  Blind spot information (BSI) System* P. 484 	
		<ul style="list-style-type: none"> Comes on if there is a problem with the system. 	<ul style="list-style-type: none"> Comes on while driving - Have your vehicle checked by a dealer. 	
	ECON Mode Indicator	<ul style="list-style-type: none"> Comes on when you press the ECON button. 	 ECON Button P. 442	

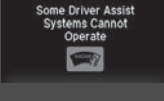

* Not available on all models

Indicator	Name	On/Blinking	Explanation	Message
	Collision Mitigation Braking System™ (CMBS™) Indicator*	<ul style="list-style-type: none"> • Comes on for a few seconds when you set the power mode to ON, then goes off. • Comes on when you deactivate the CMBS™. A multi-information display message appears for five seconds. • Comes on if there is a problem with the CMBS™. 	<ul style="list-style-type: none"> • Stays on constantly without the CMBS™ off - Have your vehicle checked by a dealer. <ul style="list-style-type: none"> ➤ Collision Mitigation Braking System™ (CMBS™)* P. 492 	

Indicator	Name	On/Blinking	Explanation	Message
	Collision Mitigation Braking System™ (CMBS™) Indicator*	<ul style="list-style-type: none"> Comes on when the CMBS™ system shuts itself off. 	<ul style="list-style-type: none"> Stays on - The area around the camera is blocked by dirt, mud, etc. Stop your vehicle in a safe place, and wipe it off with a soft cloth. <ul style="list-style-type: none"> ➤ Front Sensor Camera* P. 448 	
		<ul style="list-style-type: none"> When the radar sensor gets dirty, stop your vehicle in a safe place, and wipe off dirt using a soft cloth. Have your vehicle checked by a dealer if the message does not disappear even after you clean the sensor cover. <ul style="list-style-type: none"> ➤ Collision Mitigation Braking System™ (CMBS™)* P. 492 		
		<ul style="list-style-type: none"> Stays on - The temperature inside the camera is too high. Use the climate control system*/heating and cooling system* to cool down the camera. The system activates when the temperature inside the camera cools down. <ul style="list-style-type: none"> ➤ Front Sensor Camera* P. 448 		

Instrument Panel

* Not available on all models



Indicator	Name	On/Blinking	Explanation	Message
	<p>Bed Lights On Indicator</p>	<ul style="list-style-type: none"> • Comes on when the bed lights are on. • Comes on for 30 minutes when you set power mode to ACCESSORY or VEHICLE OFF (LOCK) without turning off the bed lights, then goes off. 	<p> Bed Lights P. 186</p>	<p>—</p>



Multi-Information Display Warning and Information Messages



The following messages appear only on the multi-information display. Press the  (information) button to see the message again with the system message indicator on.

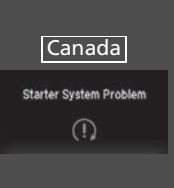

Message	Condition	Explanation
 Door Open	<ul style="list-style-type: none"> Appears if a door, the trunk or the tailgate*1 is not completely closed. 	<ul style="list-style-type: none"> Goes off when all the doors, the trunk and the tailgate are closed.
 Trunk Open		
 Tailgate Open		
 Door & Trunk Open		
 Door & Tailgate Open		
 Trunk & Tailgate Open		
 Door & Trunk & Tailgate Open		

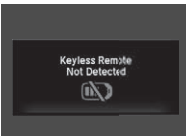
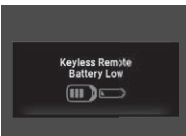
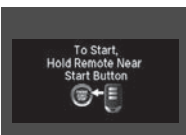

*1:When the tailgate is dropped open, the message does not appear.

Message	Condition	Explanation
 <p>Charging System Problem</p>	<ul style="list-style-type: none"> • Appears when there is a problem with the sensor on the battery. 	<ul style="list-style-type: none"> • Have your vehicle checked by a dealer. <ul style="list-style-type: none"> ➤ Checking the Battery P. 554
	<ul style="list-style-type: none"> • Appears along with the battery charging system indicator when the battery is not charging. 	<ul style="list-style-type: none"> • Turn off the climate control system */heating and cooling system * and rear defogger to reduce electricity consumption. <ul style="list-style-type: none"> ➤ If the Charging System Indicator Comes On P. 585
 <p>Maintenance Due Soon</p> <p>AB1234567</p>	<ul style="list-style-type: none"> • Appears when the scheduled maintenance is due soon. • Consequently, Maintenance Due Now and Maintenance Past Due follow. 	<ul style="list-style-type: none"> ➤ Maintenance Minder Messages on the Multi-Information Display P. 522
 <p>Engine Temperature Too Hot</p>	<ul style="list-style-type: none"> • Appears when the engine coolant temperature gets abnormally high. 	<ul style="list-style-type: none"> ➤ Overheating P. 583

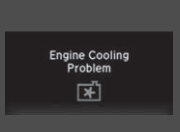
Message	Condition	Explanation
 <p>U.S. Starter System Problem STARTER SYSTEM</p>  <p>Canada Starter System Problem !</p>	<ul style="list-style-type: none"> Appears when the starter system has a problem. 	<ul style="list-style-type: none"> Hold the ENGINE START/STOP button up to 15 seconds to start the engine. <ul style="list-style-type: none"> ► Starting the Engine P. 432 Have your vehicle checked by a dealer.
 <p>Canadian models To Unlock Wheel: Push + Rotate ⊕</p>	<ul style="list-style-type: none"> Appears when the steering wheel is locked. 	<ul style="list-style-type: none"> Move the steering wheel left and right while pressing the ENGINE START/STOP button.
 <p>Accessory Mode ⊕</p>	<ul style="list-style-type: none"> Appears when the power mode is in ACCESSORY. 	<p>—</p>

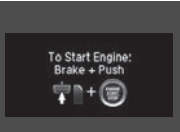
Message	Condition	Explanation
	<ul style="list-style-type: none"> Appears after the driver's door is opened when the power mode is in ACCESSORY. 	<ul style="list-style-type: none"> Press the ENGINE START/STOP button twice with your foot off the brake pedal to change the power mode to VEHICLE OFF (LOCK).
	<ul style="list-style-type: none"> Appears when you close the door with the power mode is in ON without the smart entry remote inside the vehicle. 	<ul style="list-style-type: none"> Disappears when you bring the smart entry remote back inside the vehicle and close the door. <ul style="list-style-type: none"> ➤ Smart Entry Remote Reminder P. 144
	<ul style="list-style-type: none"> Appears when the smart entry remote battery becomes weak. 	<ul style="list-style-type: none"> Replace the battery as soon as possible. <ul style="list-style-type: none"> ➤ Replacing the Button Battery P. 555
	<ul style="list-style-type: none"> Appears if the smart entry remote battery is too weak to start the engine or the key is not within operating range to start the engine. The beeper sounds six times. 	<ul style="list-style-type: none"> Bring the smart entry remote in front of the ENGINE START/STOP button. <ul style="list-style-type: none"> ➤ If the Smart Entry Remote Battery is Weak P. 577
	<ul style="list-style-type: none"> Appears three seconds after the To Start, Hold Remote Near Start Button, then To Start Engine messages appeared sequentially. 	<ul style="list-style-type: none"> Unless you bring the smart entry remote in front of the ENGINE START/STOP button, this message does not appear. <ul style="list-style-type: none"> ➤ If the Smart Entry Remote Battery is Weak P. 577



Message	Condition	Explanation
	<ul style="list-style-type: none"> Appears if there is a problem with the cooling system. 	<ul style="list-style-type: none"> Drive slowly to prevent overheating and have your vehicle checked by a dealer as soon as possible.
	<ul style="list-style-type: none"> Appears when the transmission system temperature is too high. 	<ul style="list-style-type: none"> Stop in a safe place and move the shift lever to P. Let the engine idle until the message disappears.
	<ul style="list-style-type: none"> Appears if the shift lever is in a position other than P and you press the ENGINE START/STOP button to turn the engine off. 	<ul style="list-style-type: none"> Move the shift lever to P and then press the ENGINE START/STOP button twice.
	<ul style="list-style-type: none"> Appears when you set the power mode to ACCESSORY or ON. 	<p>➤ Starting the Engine P. 432</p>

Message	Condition	Explanation
<div style="border: 1px solid black; padding: 5px; margin-bottom: 5px;">AWD models</div>  <div style="border: 1px solid black; padding: 5px; margin-top: 5px;">2WD models</div> 	<ul style="list-style-type: none"> • Appears when pressing the Intelligent Traction Management button. 	<p>➤ Intelligent Traction Management P. 443</p>

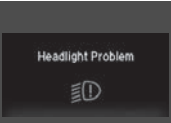
Models with LED low beam headlights

Message	Condition	Explanation
	<ul style="list-style-type: none"> • Appears if there is a problem with the headlights. 	<ul style="list-style-type: none"> • Appears while driving - The low beam headlights may not be on. When conditions allow you to drive safely, have your vehicle checked by a dealer as soon as possible.

Models with parking sensor

Message	Condition	Explanation
 <p>Parking Sensor System Problem</p>	<ul style="list-style-type: none"> • Appears if there is a problem with the parking sensor system. 	<ul style="list-style-type: none"> • Check if the area around the sensor(s) is covered with mud, ice, snow, etc. If the indicator(s) stays on or the beeper does not stop even after you clean the area, have the system checked by a dealer.
 <p>WARNING: Approaching Object</p>	<ul style="list-style-type: none"> • Appears if there are obstacles around the sensors. 	<ul style="list-style-type: none"> • Check for obstacles near your vehicle to make sure it is safe to park.

Models with ACC

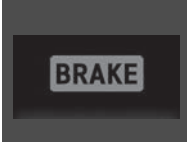
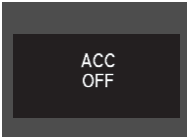
Message	Condition	Explanation
	<ul style="list-style-type: none"> Flashes when the system senses a likely collision with a vehicle in front of you. 	<ul style="list-style-type: none"> Take the appropriate means to prevent a collision (apply the brakes, change lanes, etc.) <ul style="list-style-type: none"> ➤ Collision Mitigation Braking System™ (CMBS™)* P. 492 ➤ Adaptive Cruise Control (ACC)* P. 455
	<ul style="list-style-type: none"> Appears when ACC has been automatically canceled. 	<ul style="list-style-type: none"> You can resume the set speed after the condition that caused ACC to cancel improves. Press the RES/+SET/- button. <ul style="list-style-type: none"> ➤ Adaptive Cruise Control (ACC)* P. 455

Models with washer level sensor

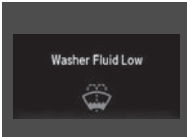

Message	Condition	Explanation
	<ul style="list-style-type: none"> Appears when the washer fluid is low. 	<ul style="list-style-type: none"> Refill washer fluid. <ul style="list-style-type: none"> ➤ Refilling Window Washer Fluid P. 536

Models with remote engine start



Message	Condition	Explanation
	<ul style="list-style-type: none"> • Appears when you unlock and open the driver's door while the engine is running by the smart entry remote. 	<p>➤ Remote Engine Start* P. 434</p>

* Not available on all models

Models with LKAS



Message	Condition	Explanation
	<ul style="list-style-type: none"> • Appears when the vehicle is driving out of a detected lane. Rapid vibrations on the steering wheel. 	<ul style="list-style-type: none"> • Keep the vehicle within the lane you are driving. • The color of either line changes from white to amber as the vehicle gets closer to that side of the lane line. <ul style="list-style-type: none"> ➤ Lane Keeping Assist System (LKAS)* P. 468
	<p>When you selected Warning Only</p> <ul style="list-style-type: none"> • Rapid vibrations on the steering wheel when the vehicle is drifting out of a detected lane. <p>When you selected Normal or Wide</p> <ul style="list-style-type: none"> • Rapid vibrations on the steering wheel with steering assist when the vehicle is drifting out of a detected lane. 	<ul style="list-style-type: none"> • Keep the vehicle within the lane you are driving. • The color of either line changes from white to amber as the vehicle gets closer to that side of the lane line. <ul style="list-style-type: none"> ➤ Road Departure Mitigation (RDM) System* P. 450
	<ul style="list-style-type: none"> • Blinks when you fail to steer the vehicle. The beeper sounds simultaneously. 	<ul style="list-style-type: none"> • Operate the steering wheel to resume the LKAS.

Models with LKAS

Message	Condition	Explanation
	<ul style="list-style-type: none"> • Appears when the LKAS is in operation, or the LKAS button is pressed, but there is a problem with a system related to the LKAS. The LKAS cancels automatically. The beeper sounds simultaneously if selected by customization. 	<ul style="list-style-type: none"> • If any other system indicators come on, such as the VSA®, ABS and brake system, take appropriate action. ► Indicators P. 74
	<ul style="list-style-type: none"> • Appears when the LKAS is in operation, or the LKAS button is pressed, but the temperature inside the LKAS camera is too high. The LKAS cancels automatically. The beeper sounds simultaneously if selected by customization. 	<ul style="list-style-type: none"> • Use the climate control system*/heating and cooling system* to cool down the camera. • Goes off - The camera has been cooled down. Pressing the LKAS button can resume the system. ► Front Sensor Camera* P. 448
	<ul style="list-style-type: none"> • Appears when the area around the camera is blocked by dirt, mud, etc. Stop your vehicle in a safe place, and clean the camera area of the windshield with a soft cloth. • May appear when driving in bad weather (rain, snow, fog, etc.) 	<ul style="list-style-type: none"> • Have your vehicle checked by a dealer if the indicator and message come back on after you cleaned the area around the camera.

* Not available on all models

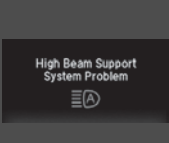
Models with Auto high-beam

Message	Condition	Explanation
 <p>High Beam Support System Problem</p>	<ul style="list-style-type: none"> Appears if there is a problem with the Auto high-beam (High Beam Support System). 	<ul style="list-style-type: none"> Manually operate the headlight switch. If you are driving with the high-beam headlights when this happens, the headlights are changed to low beams. <ul style="list-style-type: none"> ➤ Auto High-Beam (High Beam Support System)* P. 151
 <p>High Beam Support System Cannot Operate</p>	<ul style="list-style-type: none"> Appears when the area around the camera on the windshield is blocked by dirt, mud, etc. 	<ul style="list-style-type: none"> Stop your vehicle in a safe place, and clean the camera area of the windshield with a soft cloth. If the message does not disappear after cleaning the lens, have your vehicle checked by a dealer.

Gauges

Gauges include the speedometer, tachometer, fuel gauge, and related indicators. They are displayed when the power mode is in ON.

Speedometer

Displays your driving speed in mph (U.S.) or km/h (Canada).

Tachometer

Shows the number of engine revolutions per minute.

Fuel Gauge

Displays the amount of fuel left in the fuel tank.

Temperature Gauge

Displays the temperature of the engine coolant.

Speedometer

Press and hold the **RESET** button until you hear a beep when the blank appears on the multi-information display.

The speedometer reading as well as the displayed measurements will switch between mph and km/h. The display change message will switch for a few seconds.

Fuel Gauge

NOTICE

You should refuel when the reading approaches **[E]**. Running out of fuel can cause the engine to misfire, damaging the catalytic converter.

The actual amount of remaining fuel may differ from the fuel gauge reading.

Temperature Gauge

NOTICE

Driving with the temperature gauge pointer in the upper zone can cause serious engine damage. Pull safely to the side of the road and allow engine temperature to return to normal.

➤ **Overheating** P. 583

Multi-Information Display

The multi-information display shows the odometer, trip meter, outside temperature indicator*, and other gauges. It also displays important messages such as warnings and other helpful information.

Switching the Display

Press the  (information) or **RESET** button.

Instrument Panel

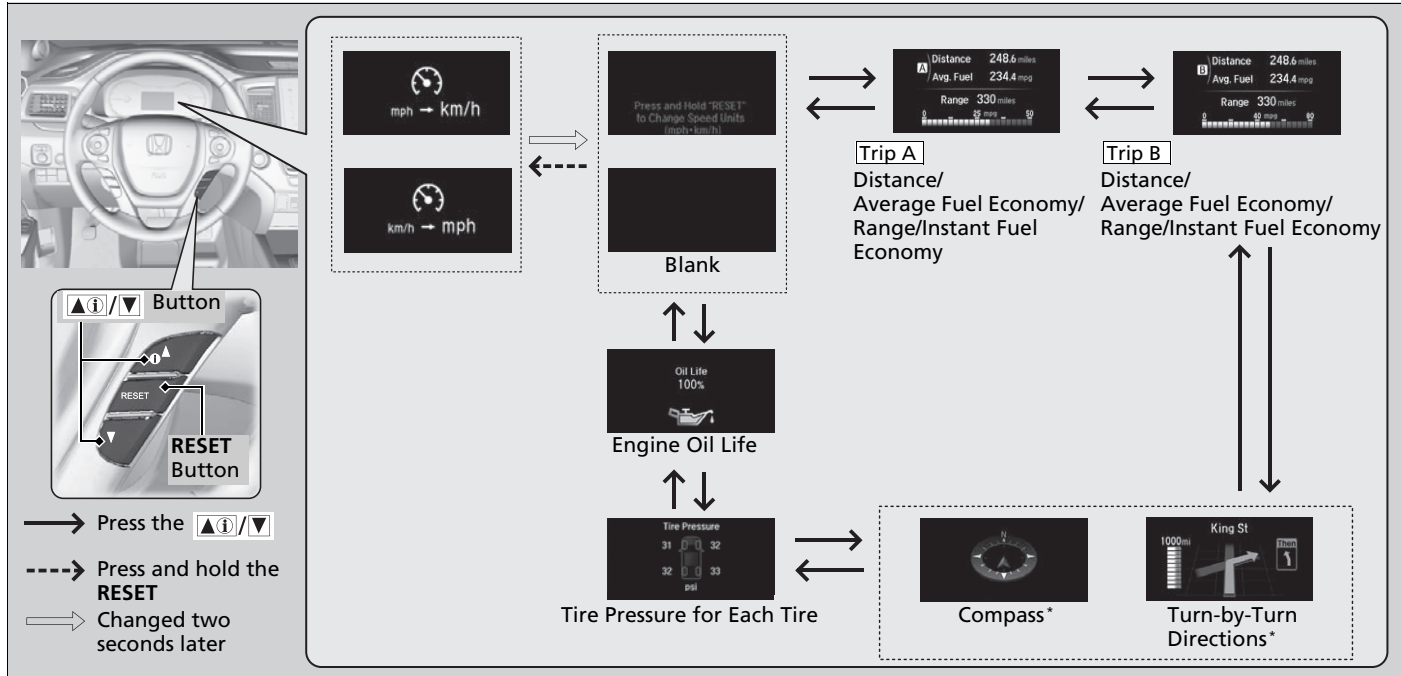

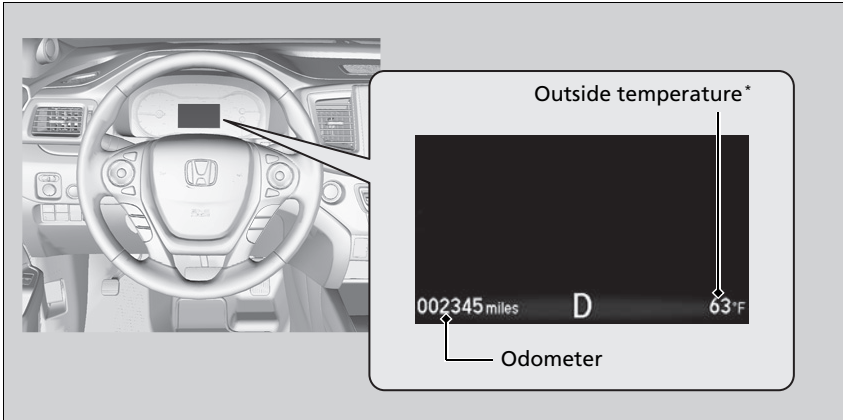

■ Odometer

Shows the total number of miles (U.S.) or kilometers (Canada) that your vehicle has accumulated.

* Not available on all models

■ Outside Temperature*

Shows the outside temperature in Fahrenheit (U.S.) or Celsius (Canada).

Models with Display Audio

■ Adjusting the outside temperature display

Adjust the temperature reading up to $\pm 5^{\circ}\text{F}$ or $\pm 3^{\circ}\text{C}$ if the temperature reading seems incorrect.

■ Trip Meter

Shows the total number of miles (U.S.) or kilometers (Canada) driven since the last reset. Meters A and B can be used to measure two separate trips.

■ Resetting a trip meter

To reset a trip meter, display it, then press and hold the **RESET** button until the trip meter is reset to **0.0**.

■ Average Fuel Economy

Shows the estimated average fuel economy of each trip meter in mpg (U.S.) or l/100 km (Canada). The display is updated at set intervals. When a trip meter is reset, the average fuel economy is also reset.

►► Outside Temperature*

The temperature sensor is located in the front bumper.

Road heat and exhaust from another vehicle can affect the temperature reading when your vehicle speed is less than 19 mph (30 km/h).

It may take several minutes for the display to be updated after the temperature reading has stabilized.

Models with Display Audio

Use the audio/information screen's customized features to correct the temperature.

► **Customized Features** P. 317

►► Trip Meter

Switch between trip meter A and trip meter B by pressing the /▼ button.

►► Average Fuel Economy

Models with Display Audio

You can change when to reset the average fuel economy.

► **Customized Features** P. 317

■ Range

Shows the estimated distance you can travel on the remaining fuel. This distance is estimated from the fuel economy of your previous trips.

■ Instant Fuel Economy

Shows the instant fuel economy as a bar graph in mpg (U.S.) or l/100 km (Canada).

■ Tire Pressure Monitor

Shows each tire's pressure.

➤ **TPMS with Tire Fill Assist** P. 480

■ Maintenance Minder™

Shows the Maintenance Minder™ information.

➤ **Maintenance Minder™** P. 521

Models with navigation system

■ Turn-by-Turn Directions

Shows you turn-by-turn driving directions to your destination linked with the navigation system.

➤ **Refer to the navigation system**

➤ Turn-by-Turn Directions

The multi-information display shows a compass when the route guidance is not used.

You can select whether the turn-by-turn display comes on or not during the route guidance.

➤ **Customized Features** P. 317

➤ **Refer to the navigation system**

Controls

This chapter explains how to operate the various controls necessary for driving.



Clock	110
Locking and Unlocking the Doors	
Key Types and Functions	111
Low Smart Entry Remote Signal Strength.....	113
Locking/Unlocking the Doors from the Outside	114
Locking/Unlocking the Doors from the Inside	121
Childproof Door Locks	123
Auto Door Locking/Unlocking	124
Opening and Closing the Tailgate	128
Opening and Closing the Trunk	130
Security System	
Immobilizer System	133
Security System Alarm.....	133

Opening and Closing the Windows	136
Opening and Closing the Moonroof*	140
Operating the Switches Around the Steering Wheel	
ENGINE START/STOP Button.....	142
Turn Signals	145
Light Switches.....	146
Fog Lights*	149
Daytime Running Lights	150
Auto High-Beam (High Beam Support System)*	151
Wipers and Washers	154
Rear Defogger/Heated Door Mirror* Button	156

Canadian models

Heated Windshield Button	156
Brightness Control	157
Driving Position Memory System*	158
Adjusting the Steering Wheel	160
Adjusting the Mirrors	
Interior Rearview Mirror	161
Power Door Mirrors	162
Adjusting the Seats	163
Interior Lights/Convenience Items	
Interior Lights	171
Interior Convenience Items	173
In-Bed Convenience Items.....	184
Climate Control System*	188
Heating and Cooling System*	195

* Not available on all models





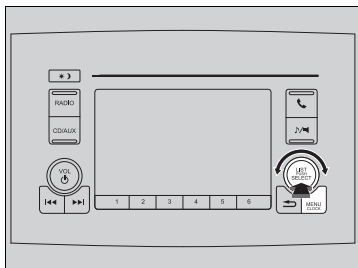

Adjusting the Clock

You can adjust the time manually in the audio/information screen, with the power mode in ON.



Adjusting the Time



Models with color audio system

1. Press and hold the **MENU/CLOCK** button.
2. Select **Adjust Clock**, then press .
3. Rotate  to adjust the hours.
4. Press  to switch to minute adjustment.
5. Rotate  to adjust the minutes.
6. Press  to switch to **Set**.
7. Press  to complete clock adjustment.

Models with Display Audio

1. Select , then select **Settings**.
2. Select **Clock/Info**, then **Clock Adjustment**.
3. Adjust the dates, hours and minutes by selecting /.
4. Select **OK** to set the time.

Clock







Models with color audio system

These indications are used to show how to operate the selector knob.

Rotate  to select.

Press  to enter.

To change the setting between **12h** and **24h**:

1. Press the **MENU/CLOCK** button.
2. Rotate  to select **Settings**, then press .
3. Rotate  to select **Clock Format**, then press .
4. Rotate  to select **12h** or **24h**, then press .

Models with navigation system

The clock is automatically updated through the navigation system, so the time does not need to be adjusted.

All models

You can customize the clock display to show the 12 hour clock or 24 hour clock.

➤ **Customized Features** P. 317

Key Types and Functions

This vehicle comes with the following keys:

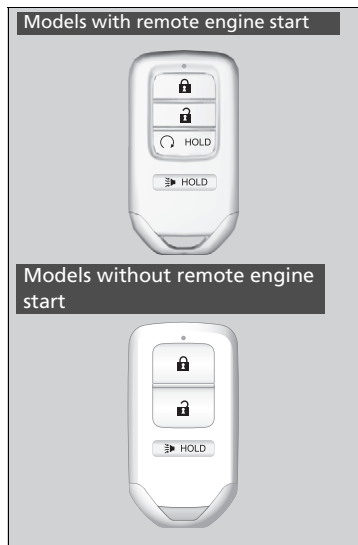

Use the keys to start and stop the engine, and to lock or unlock all the doors or open the trunk.

Key Types and Functions

All the keys have an immobilizer system. The immobilizer system helps to protect against vehicle theft.

Immobilizer System P. 133

The keys contain precision electronics.

Adhere to the following advice to prevent damage to the electronics:

- Do not leave the keys in direct sunlight, or in locations with high temperature or high humidity.
- Do not drop the keys or set heavy objects on them.
- Keep the keys away from liquids.
- Do not take the keys apart except for replacing the battery.

If the circuits in the keys are damaged, the engine may not start, and the smart entry system may not work.

If the keys do not work properly, have them inspected by a dealer.

Models with remote engine start

You can remotely start the engine using the remote engine start.

Remote Engine Start* P. 434

* Not available on all models

■ Smart entry remote

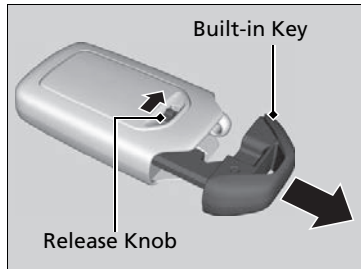

The built-in key can be used to lock/unlock the doors or open the trunk when the smart entry remote battery becomes weak or the power door lock/unlock operation is disabled.

To remove the built-in key, slide the release knob and then pull out the key. To reinstall the built-in key, push the built-in key into the smart entry remote until it clicks.

■ Key Number Tag

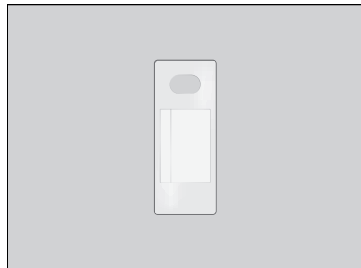

Contains a number that you will need if you purchase a replacement key.

▣ Key Number Tag

Keep the key number tag separate from the key in a safe place outside of your vehicle. If you wish to purchase an additional key, contact a dealer.

If you lose your key and you cannot start the engine, contact a dealer.

Low Smart Entry Remote Signal Strength

The vehicle transmits radio waves to locate the smart entry remote when locking/unlocking the doors, opening the trunk, or to start the engine.

In the following cases, locking/unlocking the doors, opening the trunk, or starting the engine may be inhibited or operation may be unstable:

- Strong radio waves are being transmitted by nearby equipment.
- You are carrying the smart entry remote together with telecommunications equipment, laptop computers, cell phones, or wireless devices.
- A metallic object is touching or covering the smart entry remote.

Low Smart Entry Remote Signal Strength

Communication between the smart entry remote and the vehicle consumes the smart entry remote's battery.

The smart entry remote battery lasts about two years. This changes by how often you use the remote.

The battery is consumed whenever the smart entry remote is receiving strong radio waves. Avoid placing it near electrical appliances such as televisions and personal computers.

Locking/Unlocking the Doors from the Outside

■ Using the Smart Entry with Push Button Start System *

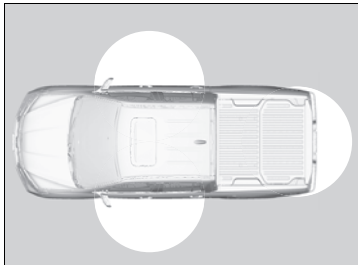

When you carry the smart entry remote, you can lock/unlock the doors or open the trunk.

You can lock/unlock the doors within a radius of about 32 inches (80 cm) of the outside door handle. You can open the trunk within about 32 inches (80 cm) radius from the trunk release button.

▣ Locking/Unlocking the Doors from the Outside

If the interior light switch is in the door activated position, the interior light comes on when you unlock the doors.

No doors opened: The light fades out after 30 seconds.

Doors relocked: The light goes off immediately.

▣ **Interior Lights** P. 171

▣ Using the Smart Entry with Push Button Start System *

If you do not open a door within 30 seconds of unlocking the vehicle with the smart entry system, the doors will automatically relock.

You can lock or unlock doors using the smart entry system only when the power mode is in VEHICLE OFF.

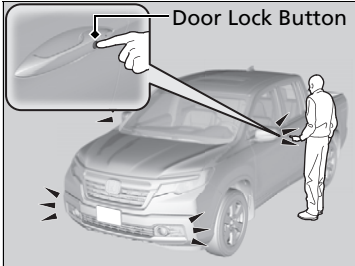

■ Locking the doors

Press the door lock button on a front door.

- ▶ Some exterior lights flash; the beeper sounds; all the doors lock; and the security system sets.

☒ Using the Smart Entry with Push Button Start System*

- Do not leave the smart entry remote in the vehicle when you get out. Carry it with you.
- Even if you are not carrying the smart entry remote, you can lock or unlock the doors or open the trunk while someone else with the remote is within range.
- The door may be unlocked if the door handle is covered with water in heavy rain or in a car wash if the smart entry remote is within range.
- If you grip a door handle wearing gloves, the door sensor may be slow to respond or may not respond by unlocking the doors.
- After locking the door, wait at least two seconds before unlocking it by gripping the handle.
- The door might not open if you pull it immediately after gripping the door handle. Grip the handle again and confirm that the door is unlocked before pulling the handle.
- Even within the 32 inches (80 cm) radius, you may not be able to lock/unlock the doors with the smart entry remote if it is above or below the outside handle.
- The smart entry remote may not operate if it is too close to the door and door glass.

* Not available on all models

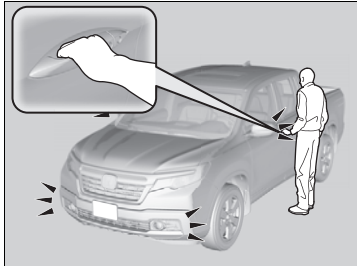

■ Unlocking the doors and trunk

Grab the driver's door handle:

- ▶ The driver's door unlocks.
- ▶ Some exterior lights flash twice and the beeper sounds twice.

Grab the front passenger's door handle:

- ▶ All doors unlock.
- ▶ Some exterior lights flash twice and the beeper sounds twice.

Press the trunk release button:

- ▶ The trunk unlocks and opens.
- ▶ The beeper sounds once.

➤ **Using the Trunk Release Button** P. 131

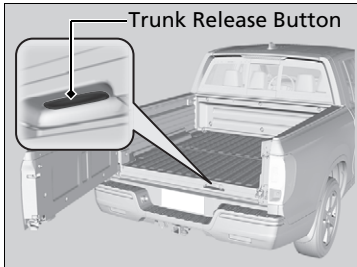

▶▶ Using the Smart Entry with Push Button Start System*

Models with Display Audio

The light flash, beep and door unlock mode settings can be customized using the audio/information screen.

➤ **Customized Features** P. 317

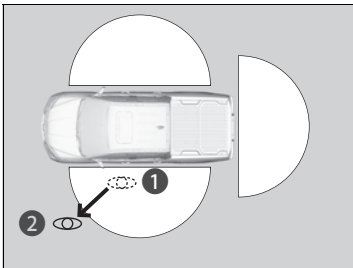
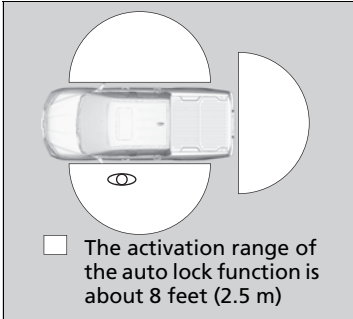

■ Locking the vehicle (Walk away auto lock)*

When you walk away from the vehicle while carrying the smart entry remote, the doors will automatically lock.

The auto lock function activates when all doors and trunk are closed, and the smart entry remote is within about 8 feet (2.5 m) radius of the outside door handle.

Exit vehicle while carrying smart entry remote and close door(s).

1. While within about 8 feet (2.5 m) radius of the vehicle.
 - ▶ The beeper sounds; the auto lock function will be activated.
2. Carry the smart entry remote beyond about 5 feet (1.5 m) from the vehicle and remain outside this range for 2 or more seconds.
 - ▶ Some exterior lights flash; the beeper sounds; all doors will then lock.

☒ Locking the vehicle (Walk away auto lock)*

The auto lock function is set to OFF as the factory default setting. The auto lock function can be set to ON using the audio/information screen.

▶ **Customized Features** P. 317

After the auto lock function has been activated, when you stay within the locking/unlocking operation range, the indicator on the smart entry remote will continue to flash until the doors are locked.

When you stay beside the vehicle within the operation range, the doors will automatically lock approximately 30 seconds after the auto lock function activating beeper sounds.

When you open a door after the auto lock function activating beeper sounds, the auto lock function will be canceled.

When all doors and trunk have been closed and the smart entry remote is inside the vehicle, or if the smart entry remote is not detected within about 8 feet (2.5 m) of the vehicle, auto lock function will not be activated.

To temporarily deactivate the function:

1. Set the power mode to VEHICLE OFF (LOCK).
2. Open the driver's door.
3. Using the master door lock switch, operate the lock as follows:
Lock → Unlock → Lock → Unlock.
► The beeper sounds and the function is deactivated.

To restore the function:

- Set the power mode to ON.
- Lock the vehicle without using the auto lock function
- Open or close the door.

► Locking the vehicle (Walk away auto lock)*

The auto lock function does not operate when any of the following conditions are met.

- The smart entry remote is inside the vehicle.
- A door or the hood is not closed.
- The power mode is set to any mode other than OFF.
- The smart entry remote is not located within a radius of about 8 feet (2.5 m) from the vehicle when you get out of the vehicle and close the doors.

Auto lock function operation stop beeper

After the auto lock function has been activated, the auto lock operation stop beeper sounds for approximately two seconds in the following cases.

- The smart entry remote is put inside the vehicle through a window.
- You are located too close to the vehicle.
- The smart entry remote is put inside the trunk.

If the warning beeper sounds, check that you are carrying the smart entry remote. Then, open/close a door and confirm the auto lock activation beeper sounds once.

■ Using the Remote Transmitter

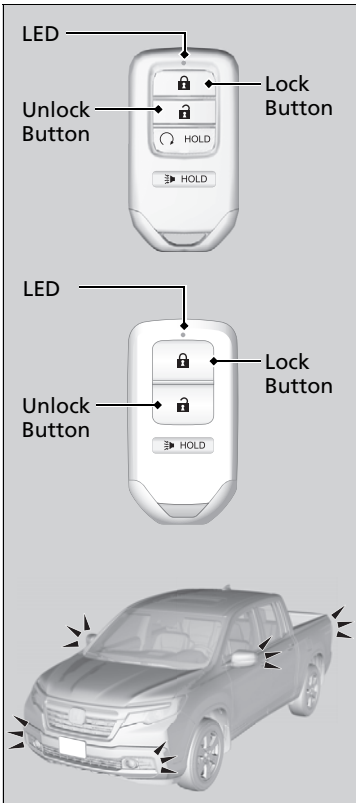

■ Locking the doors

Press the lock button.

Once:

- ▶ Some exterior lights flash, all the doors lock, and the security system sets.

Twice (within five seconds after the first push):

- ▶ Some exterior lights flash, the beeper sounds and verifies the security system is set.

■ Unlocking the doors

Press the unlock button.

Once:

- ▶ Some exterior lights flash twice, and the driver's door unlocks.

Twice:

- ▶ Some exterior lights flash twice, the remaining doors unlock.

⊗ Using the Remote Transmitter

If you do not open a door within 30 seconds of unlocking the vehicle with the remote transmitter, the doors will automatically relock.

Models with Display Audio

You can change the relock timer setting.

⊗ Customized Features P. 317

You can lock or unlock the doors using the remote transmitter only when the power mode is in VEHICLE OFF.

The remote transmitter uses low-power signals, so the operating range may vary depending on the surroundings.

The remote will not lock the vehicle when a door is open.

If the distance at which the remote transmitter works varies, the battery is probably low. If the LED does not come on when you press a button, the battery is dead.

⊗ Replacing the Button Battery P. 555

Models with Display Audio

You can customize the door lock mode and keyless lock acknowledgement setting.

⊗ Customized Features P. 317

■ Locking/Unlocking the Doors Using a Key

If the smart entry remote battery or the vehicle battery is dead, use the key instead of the smart entry remote.

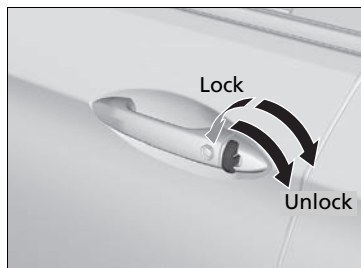

Fully insert the key and turn it.

▶▶ Locking/Unlocking the Doors Using a Key

When you lock the driver's door with a key, all the other doors and trunk lock at the same time. When unlocking, the driver's door unlocks first. Turn the key a second time within a few seconds to unlock the remaining doors and the trunk.

Models with Display Audio

You can customize the door unlock mode setting.

▶ **Customized Features** P. 317

■ Locking a Door Without Using a Key

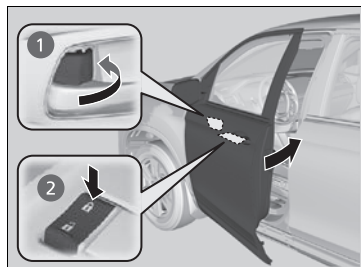

■ Locking the front doors

Push the lock tab forward ① or push the master door lock switch in the lock direction ②, and close the door.

■ Locking the rear doors

Push the lock tab forward and close the door.

▶▶ Locking a Door Without Using a Key

When you lock the driver's door or the passenger's door, all the other doors lock at the same time. Make sure you have the key in your hand when you lock the driver's door, any of the other doors or the trunk, otherwise you may end up locking the key inside the vehicle.

■ Lockout prevention system

The door cannot be locked when any door is open. If trunk is open, door can be locked.

Locking/Unlocking the Doors from the Inside

■ Using the Lock Tab

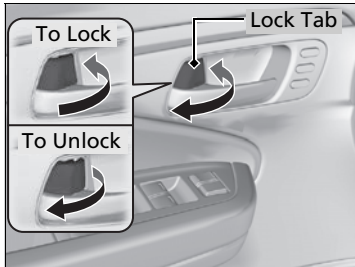

■ Locking a door

Push the lock tab forward.

■ Unlocking a door

Pull the lock tab rearward.

☒ Using the Lock Tab

When you lock the door using the lock tab on the driver's door, all the other doors lock at the same time.

When you unlock the door using the lock tab on the driver's door, only the driver's door will unlock.

■ Unlocking Using the Front Door Inner Handle



Pull the front door inner handle.

- ▶ The door unlocks and opens in one motion.

Unlocking and opening the driver's door from the inner handle unlocks all the other doors.

To avoid unlocking all the doors, use the lock tab on the driver's door to unlock, then lock again before opening the door.

- ▶ This setting works for one time only.

Models with Display Audio

If you do not want all the doors to be unlocked all the time, customize the **Auto Door Unlock** setting to **Off** using the audio/information screen.

☒ Unlocking Using the Front Door Inner Handle

The front door inner handles are designed to allow front seat occupants to open the door in one motion. However, this feature requires that front seat occupants never pull a front door inner handle while the vehicle is in motion.

Children should always ride in a rear seat where childproof door locks are provided.

☒ **Childproof Door Locks** P. 123

■ Using the Master Door Lock Switch

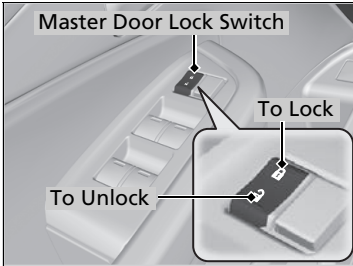

Press the master door lock switch on either front door to lock or unlock all the doors.

☒ Using the Master Door Lock Switch

When you lock or unlock either front door using the master door lock switch, all the other doors lock or unlock at the same time.

Childproof Door Locks

The childproof door locks prevent the rear doors from being opened from the inside regardless of the position of the lock tab.

☒ Childproof Door Locks

To open the door from the inside when the childproof door lock is on, put the lock tab in the unlock position, lower the rear window, put your hand out of the window, and pull the outside door handle.

■ Setting the Childproof Door Locks

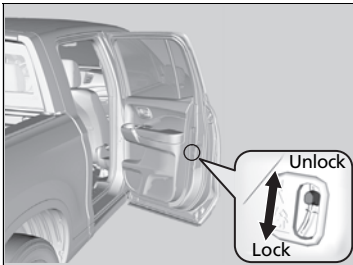

Slide the lever in the rear door to the lock position, and close the door.

■ When opening the door

Open the door using the outside door handle.

Auto Door Locking/Unlocking

Your vehicle locks all doors and unlocks all doors or the driver's door automatically when a certain condition is met.

■ Auto Door Locking

■ Drive lock mode

All doors and trunk lock when the vehicle's speed reaches about 10 mph (15 km/h).

■ Auto Door Unlocking

■ Driver's door open mode

All doors unlock when the driver's door is opened.

▶▶ Auto Door Locking/Unlocking

■ Models with Display Audio

You can turn off or change to another auto door locking/unlocking setting using the audio/information screen.

▶ **Customized Features** P. 317

Customizing the Auto Door Locking/Unlocking Setting*

You can customize the auto door locking/unlocking setting to your liking using the master door lock switch.

List of the Auto Door Locking/Unlocking Customizable Options

■ Auto door locking



Mode	Description
Drive Lock Mode^{*1}	All doors lock when the vehicle's speed reaches about 10 mph (15 km/h).
Off	The auto door locking is deactivated all the time.

■ Auto door unlocking

Mode	Description
Driver's Door Open Mode^{*1}	All doors unlock when the driver's door is opened.
Park Unlock Mode	All doors unlock when the shift lever is moved into P with the brake pedal depressed.
Off	The auto door unlocking is deactivated all the time.

*1:Default setting

■ Customizing Flow for Auto Door Locking Options

Steps	Drive Lock Mode*1	Off
1	Apply the parking brake.	Apply the parking brake.
2	Close the driver's door.	Open the driver's door.
3	Set the power mode to ON.	Set the power mode to ON.
4	<p>Press and hold the lock side of the master door lock switch on the driver's door for more than five seconds. Release the switch after you hear a click twice.</p> 	<p>Press and hold the lock side of the master door lock switch on the driver's door for more than five seconds. Release the switch after you hear one click.</p> 
5	<p>Set the power mode to ACCESSORY within 20 seconds. ▶ Customization is completed.</p>	

*1:Default setting

■ Customizing Flow for Auto Door Unlocking Options

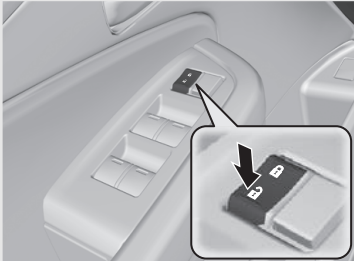
Steps	Driver's Door Open Mode*1	Park Unlock Mode	Off
1	Apply the parking brake. Move the shift lever out of P .	Apply the parking brake. Move the shift lever to P .	Apply the parking brake. Move the shift lever to P .
2	Close the driver's door.		Open the driver's door.
3	Set the power mode to ON.		Set the power mode to ON.
4	<p>Press and hold the unlock side of the master door lock switch on the driver's door for more than five seconds. Release the switch after you hear a click twice.</p> 		
5	<p>Set the power mode to ACCESSORY within 20 seconds. ▶ Customization is completed.</p>		

*1:Default setting

Precautions for Opening/Closing the Tailgate

Always make sure individuals and objects are clear of the tailgate before opening or closing it.

■ Opening the tailgate

- Support the tailgate with your hands until it has completely opened.
- Be careful when it is windy. The wind may cause the tailgate to close when it is in the swing open position.

■ Closing the tailgate

Unless absolutely necessary, close the tailgate before driving.

ⓘ Precautions for Opening/Closing the Tailgate

WARNING

Anyone caught in the path of a tailgate that is being opened or closed can be seriously injured.

Make sure that all people are clear of the tailgate before opening or closing it.

Be careful not to put your hands between the tailgate and the cargo area when closing the tailgate.

When you are storing or picking up luggage from the cargo area while the engine is idling, do not stand in front of the exhaust pipe. You may get burned.

WARNING

Allowing passengers to ride in the pickup bed or on the tailgate can result in death or serious injury in a crash.

Make sure all passengers ride in a seat and wear a seat belt properly.

Using the Tailgate Release Handle

■ Drop Open the Tailgate

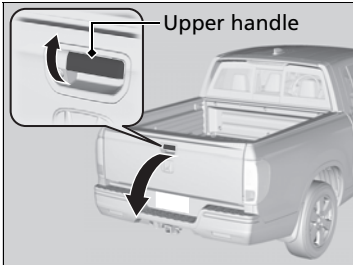

Pull up the upper handle to drop open the tailgate.

- ▶ Make sure to hold the tailgate until it is fully opened.

■ Swing Open the Tailgate

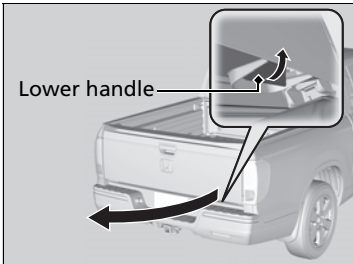

Pull up the lower handle to swing open the tailgate.

☒ Using the Tailgate Release Handle

NOTICE

As a safety feature, the upper handle is disabled if you do not fully close the tailgate after it is swung open. Likewise, the lower handle is disabled if you do not fully close the tailgate after it is dropped open.

☒ Swing Open the Tailgate

The tailgate can be swing open in two steps.

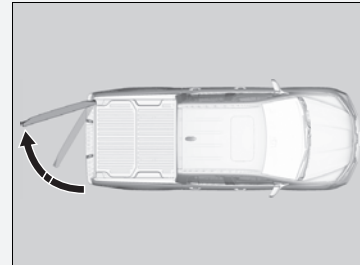

The bed lights come on when you swing open the tailgate.

Precautions for Opening/Closing the Trunk

■ Opening the trunk

Open the trunk all the way.

- ▶ If it is not fully opened, the trunk lid may begin to close under its own weight.

■ Closing the trunk

Keep the trunk lid closed while driving to:

- ▶ Avoid possible damage.

Using the key

If the smart entry remote battery or the vehicle battery is dead, use the key instead of the smart entry remote.

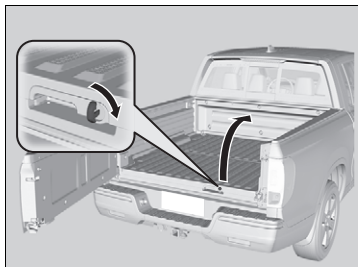

1. Swing open the tailgate.
2. Fully insert the key and turn it.
3. Open the trunk.

ⓘ Opening and Closing the Trunk

⚠ WARNING

Swinging the tailgate open or closed while anyone is in its path can cause serious injury.

Make sure all passengers are clear of the tailgate's path before opening or closing it.

Using the Trunk Release Button

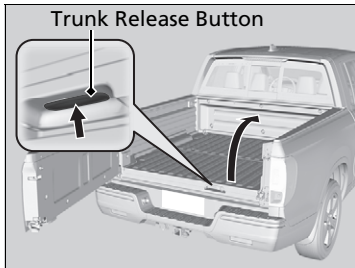

Push up the trunk release button on the trunk lid after all the doors are unlocked.

Even if the trunk is locked, you can open the trunk if you carry the smart entry remote.

- ▶ The beeper will sound.

Trunk Main Switch

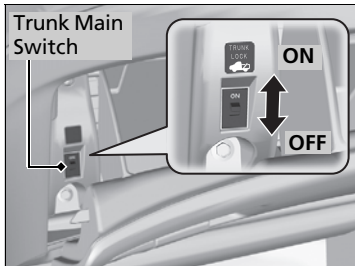

The trunk main switch disables the trunk release button on the trunk lid to protect luggage in the trunk.

1. Turn off the trunk main switch in the glove box.
2. Lock the glove box.

Using the Trunk Release Button

- If you forget the remote inside, the beeper will sound and the trunk will not close.
- A person who is not carrying the smart entry remote can unlock the trunk if a person who is carrying it is within range.
- Do not leave the smart entry remote inside the trunk and close the lid. The beeper sounds and the trunk cannot be closed.
- Do not carry the smart entry remote near the trunk lid when closing it.

Trunk Main Switch

If you need to give the key to someone else, remove the built-in key from the smart entry remote by sliding the release knob, and give the remote as a valet key.

Emergency Trunk Opener

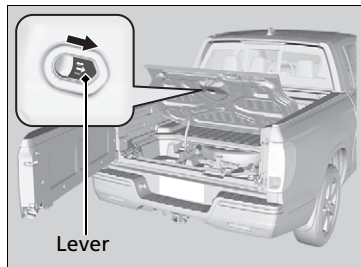

The trunk release lever allows you to open the trunk from inside for your safety.

Slide the release lever in the direction of the arrow.

Emergency Trunk Opener

Parents should decide if their children should be shown how to use this feature.

Immobilizer System

The immobilizer system prevents a key that has not been pre-registered from starting the engine. Each key contains electronic transmitters that use electronic signals to verify the key.

Pay attention to the following when pressing the **ENGINE START/STOP** button:

- Do not allow objects that emit strong radio waves near the **ENGINE START/STOP** button.
- Make sure the key is not covered by or touching a metal object.
- Do not bring a key from another vehicle's immobilizer system near the **ENGINE START/STOP** button.
- Do not put the key near magnetic items. Electronic device such as televisions and audio systems emit strong magnetic fields. Note that even a key chain can become magnetic.

Security System Alarm

The security system alarm activates when the trunk, hood or doors are forcibly opened. The alarm does not go off if the trunk or doors are opened with the key, remote transmitter or smart entry with push button start system.

However, the alarm goes off if a door is opened with the key and the shift lever is moved out of **P** or the hood is opened before the power mode is set to ON.

■ When the security system alarm activates

The horn sounds intermittently, some exterior lights flash.

Immobilizer System

NOTICE

Leaving the smart entry remote in the vehicle can result in theft or accidental movement of the vehicle. Always take the key with you whenever you leave the vehicle unattended.

Do not alter the system or add other devices to it. Doing so may damage the system and make your vehicle inoperable.

Security System Alarm

Do not alter the system or add other devices to it. Doing so may damage the system and make your vehicle inoperable.

The security alarm continues for a maximum of two minutes until the security system alarm deactivates.

■ To deactivate the security system alarm

Unlock the vehicle using the key, remote transmitter, or smart entry with push button start system. The system, along with the horn and flashing lights, is deactivated.

■ Setting the security system alarm

The security system alarm automatically sets when the following conditions have been met:

- The power mode is set to VEHICLE OFF (LOCK).
- The hood and trunk are closed.
- All doors are locked from outside with the key, remote transmitter, or smart entry system.

■ When the security system alarm sets

The security system alarm indicator in the instrument panel blinks. When the blinking interval changes after about 15 seconds, the security system alarm is set.

■ To cancel the security system alarm

The security system alarm is canceled when the vehicle is unlocked using the key, remote transmitter, smart entry system, or the power mode is set to ON. The security system alarm indicator goes off at the same time.

⌘ Security System Alarm

Do not set the security system alarm when someone is in the vehicle or a window is open. The system can accidentally activate when:

- Unlocking the door with the lock tab.
- Opening the trunk with the trunk release or the emergency trunk opener.
- Opening the hood with the hood release.
- Moving the shift lever out of **P**.

If the battery goes dead after you have set the security system alarm, the security alarm may go off once the battery is recharged or replaced.

If this occurs, deactivate the security system alarm by unlocking a door using the key, remote transmitter, or smart entry system.

■ Panic Mode



■ The panic button on the remote transmitter

If you press the panic button for approximately one second, the following will occur for about 30 seconds:

- The horn sounds.
- Some exterior lights flash.

■ Canceling panic mode

Press any button on the remote transmitter, or set the power mode to ON.

Opening/Closing the Power Windows

The power windows can be opened and closed when the power mode is in ON, using the switches on the doors. The driver's side switches can be used to open and close all the windows.

The power window lock button on the driver's side must be switched off (not pushed in, indicator off) to open and close the windows from anywhere other than the driver's seat.

When the power window lock button is pushed in, the indicator comes on and you can only operate the driver's window. Turn the power window lock button on if a child is in the vehicle.

Opening/Closing the Power Windows

WARNING

Closing a power window on someone's hands or fingers can cause serious injury.

Make sure your passengers are away from the windows before closing them.

The power windows can be operated for up to 10 minutes after you set the power mode to VEHICLE OFF (LOCK). Opening either front door cancels this function.

Auto Reverse

If a power window senses resistance when closing automatically, it will stop closing and reverse direction.

The driver's window auto reverse function is disabled when you continuously pull up the switch.

The auto reverse function stops sensing when the window is almost closed to ensure that it fully closes.

Opening/Closing Windows with Auto-Open/Close Function

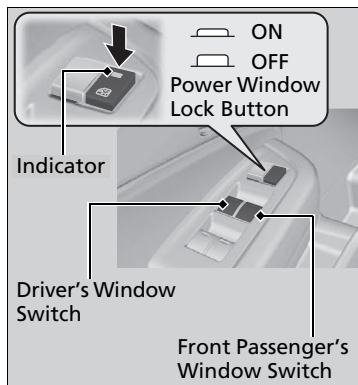

■ Manual operation

To open: Push the switch down lightly, and hold it until the desired position is reached.

To close: Pull the switch up lightly, and hold it until the desired position is reached.

■ Automatic operation (front windows)

To open: Push the switch down firmly.

To close: Pull the switch up firmly.

The window opens or closes completely. To stop the window at any time, push or pull the switch briefly.

Opening/Closing Windows without Auto-Open/Close Function

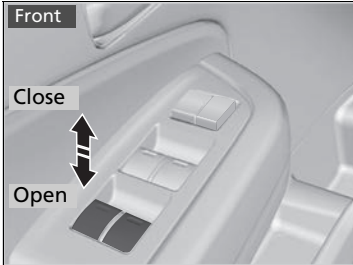

To open: Push the switch down.

To close: Pull the switch up.

Release the switch when the window reaches the desired position.

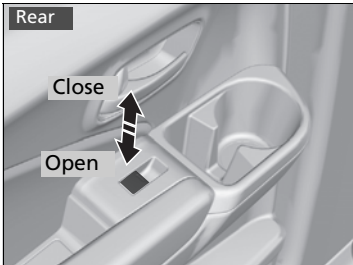

■ Opening/Closing Back Window*

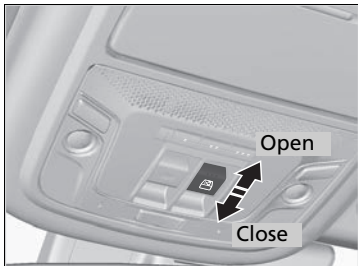

To open: Pull the switch back.

To close: Push the switch forward.
Release the switch when the window reaches the desired position.

■ Opening Windows and the Moonroof* with the Remote



To open: Press the unlock button, and then within 10 seconds, press it again and hold it.

If the windows and Moonroof* stop midway, repeat the procedure.

☒ Opening/Closing Back Window*

This switch opens and closes the back window only.

■ Opening/Closing Windows and the Moonroof* with the Key

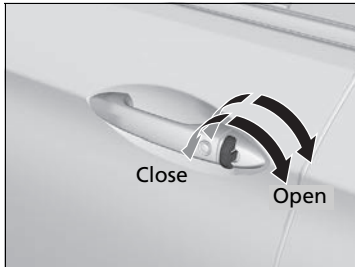

To open: Unlock the driver's door with the key. Within 10 seconds of returning the key to the central position, turn the key in the unlock direction and hold it there.

To close: Lock the driver's door with the key. Within 10 seconds of returning the key to the central position, turn the key in the lock direction and hold it there.

Release the key to stop the windows and the moonroof* at the desired position. If you want further adjustment, repeat the same operation.

* Not available on all models

Opening and Closing the Moonroof*

■ Opening/Closing the Moonroof

You can only operate the moonroof when the power mode is in ON. Use the switch in the front of the ceiling to open and close the moonroof.

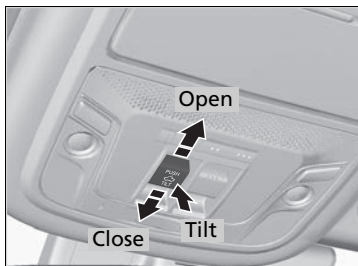

■ Automatic operation

To open: Pull the switch back firmly.

To close: Push the switch forward firmly.

The moonroof will automatically open or close all the way. To stop the moonroof midway, push the switch briefly.

☞ Opening/Closing the Moonroof

⚠ CAUTION

Opening or closing the moonroof on someone's hands or fingers can cause serious injury.

Make sure all hands and fingers are clear of the moonroof before opening or closing it.

NOTICE

Opening the moonroof in below freezing temperature or when it is covered with snow or ice can damage the moonroof panel or motor.

The power moonroof can be operated for up to 10 minutes after you set the power mode to VEHICLE OFF (LOCK).

Opening either front door cancels this function.

■ Manual operation

To open: Pull the switch back lightly, and hold it until the desired position is reached.

To close: Push the switch forward lightly, and hold it until the desired position is reached.

■ Tilting the moonroof up

To tilt: Push on the center of the moonroof switch.

To close: Push the switch forward firmly, then release.

☒ Opening/Closing the Moonroof

When resistance is detected, the auto reverse function causes the moonroof to change directions, then stop. Auto reverse stops sensing when the moonroof is almost closed to ensure that it fully closes. Make sure that all objects, including fingers, are clear of the moonroof.

You can use the remote transmitter or the key to operate the moonroof.

☒ **Opening Windows and the Moonroof* with the Remote** P. 138

☒ **Opening/Closing Windows and the Moonroof* with the Key** P. 139

* Not available on all models

ENGINE START/STOP Button

Changing the Power Mode



VEHICLE OFF (LOCK)

The button is off.
The steering wheel is locked*1.
The power to all electrical components is turned off.
Blinking in white (when the door is open)



ACCESSORY

The button blinks (in red).
Operate the audio system and other accessories in this position.



ON

The button is on in red.
All electrical components can be used.

Without pressing the brake pedal



Press the button.



Press the button without the shift lever in **P**.



Shift to **P***2.



Shift to **P**, then press the button.

*1:Canadian models

*2:U.S. models

ENGINE START/STOP Button

ENGINE START/STOP Button Operating Range

You can start the engine when the smart entry remote is inside the vehicle.

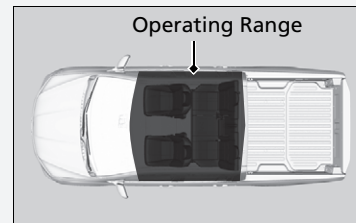

If the smart entry remote battery is weak, beeper sounds and the **To Start, Hold Remote Near Start Button** message appears on the multi-information display.

If the Smart Entry Remote Battery is Weak P. 577

The engine may also run if the smart entry remote is close to the door or window, even if it is outside the vehicle.

ON mode:

The **ENGINE START/STOP** button is red when the engine is running.

Automatic Power Off

If you leave the vehicle for 30 to 60 minutes with the shift lever in **[P]** and the power mode in ACCESSORY, the vehicle automatically goes into the mode similar to VEHICLE OFF (LOCK) to avoid draining the battery.

Canadian models

When in this mode:

The steering wheel does not lock.

You cannot lock or unlock doors with the remote transmitter or the smart entry system.

Press the **ENGINE START/STOP** button to switch the mode to VEHICLE OFF (LOCK).

Power Mode Reminder

If you open the driver's door when the power mode is set to ACCESSORY, a warning beep sounds.

ENGINE START/STOP Button

Canadian models

If the power mode does not change from VEHICLE OFF to ACCESSORY, press the **ENGINE START/STOP** button while moving the steering wheel left and right. The steering wheel will unlock, allowing the mode to change.

Do not leave the power mode in ACCESSORY or ON when you get out.

■ Smart Entry Remote Reminder

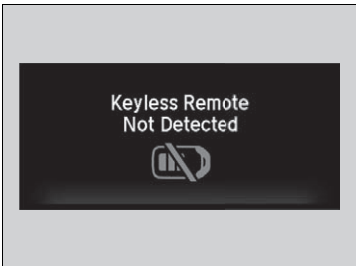

Warning buzzers may sound from inside and/or outside the vehicle to remind you that the smart entry remote is out of the vehicle. If the buzzer continues even after the remote is put back inside, place it within its operational range.

■ When the power mode is in ON

If the smart entry remote is taken out of the vehicle, and the driver's door is closed, a warning buzzer sounds from both inside and outside the vehicle. Furthermore, a warning message on the multi-information display notifies the driver inside that the remote is outside of the vehicle.

■ When the power mode is in ACCESSORY

If the smart entry remote is taken out of the vehicle, and/or all the doors are closed, a warning buzzer sounds from outside the vehicle.

▶▶ Smart Entry Remote Reminder

When the smart entry remote is within the system's operational range, and the driver's door is closed, the warning function cancels.

If the smart entry remote is taken out of the vehicle after the engine has been started, you can no longer change the **ENGINE START/STOP** button mode or restart the engine. Always make sure if the remote is in your vehicle when you operate the **ENGINE START/STOP** button.

Removing the smart entry remote from the vehicle through a window does not activate the warning buzzer.

Do not put the smart entry remote on the dashboard or in the glove box. It may cause the warning buzzer to go off. Under some other conditions that can prevent the vehicle from locating the remote, the warning buzzer may also go off even if the remote is within the system's operational range.

Turn Signals

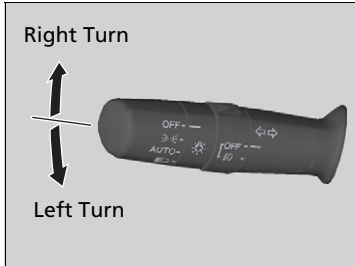

The turn signals can be used when the power mode is in ON.

■ One-touch turn signal

When you lightly push up or down and release the turn signal lever, the exterior turn signals and turn signal indicator blink three times. This feature can be used when signaling for a lane change.

Light Switches

Manual Operation

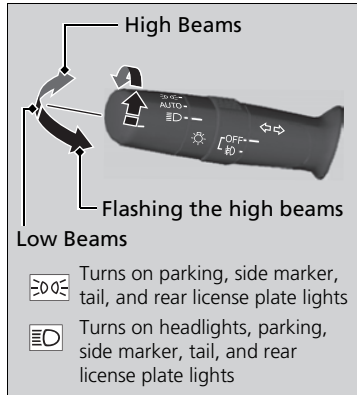

Rotating the light switch turns the lights on and off, regardless of the power mode setting.

■ High beams

Push the lever forward until you hear a click.

■ Low beams

When in high beams, pull the lever back to return to low beams.

■ Flashing the high beams

Pull the lever back, and release it.

Light Switches

If you leave the power mode in VEHICLE OFF (LOCK) with the lights on, a light on reminder chime sounds when you open the driver's door.

When the lights are on, the indicator in the instrument panel will be on.

Indicators P. 74

Do not leave the lights on when the engine is off because it will cause the battery to discharge.

If you sense that the level of the headlights is abnormal, have the vehicle inspected by a dealer.

Automatic Operation (automatic lighting control)



Automatic lighting control can be used when the power mode is in ON.

When you turn the light switch to **AUTO**, the headlights and other exterior lights will switch on and off automatically depending on the ambient brightness.

Models with Display Audio

▶ You can change the auto light sensitivity setting.

➤ **Customized Features** P. 317

Automatic Operation (automatic lighting control)

We recommend that you turn on the lights manually when driving at night, in a dense fog, or in dark areas such as long tunnels or parking facilities.

The light sensor is in the location shown below. Do not cover this light sensor with anything; otherwise, the automatic lighting system may not work properly.

Models with automatic intermittent wipers

Light Sensor

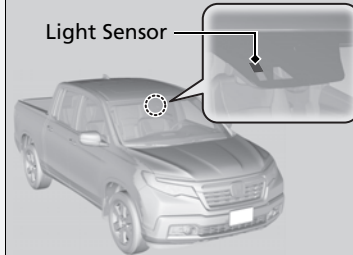

Models without automatic intermittent wipers

Light Sensor

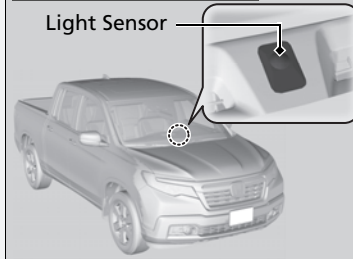

■ Headlight Integration with Wiper

The headlights automatically come on when the wipers are used several times within a certain number of intervals with the headlight switch in **AUTO**.

The headlights automatically go off a few minutes later if the wipers are stopped.

■ Automatic Lighting Off Feature

The headlights, all other exterior lights, and the instrument panel lights turn off 15 seconds after you set the power mode to VEHICLE OFF (LOCK), take the remote with you, and close the driver's door.

If you set the power mode to VEHICLE OFF (LOCK) with the headlight switch on, but do not open the door, the lights turn off after 10 minutes (three minutes, if the switch is in the **AUTO** position).

The lights turn on again when you unlock or open the driver's door. If you unlock the door, but do not open it within 15 seconds, the lights go off. If you open the driver's door, you will hear a lights on reminder chime.

▶▶ Automatic Operation (automatic lighting control)

Adjust the auto light sensitivity as follows:

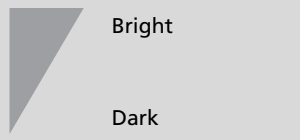
Setting	The exterior lights come on when the ambient light is at
Max	
High	
Mid	
Low	
Min	

▶▶ Headlight Integration with Wiper

This feature activates while the headlights are off in **AUTO**.

The instrument panel brightness does not change when the headlights come on.

When the ambient light is dark, the automatic lighting control feature overrides, and the headlights come on with or without the wipers sweeping more than several times.

▶▶ Automatic Lighting Off Feature

Models with Display Audio
 You can change the headlight auto off timer setting.
 ▶ **Customized Features** P. 317

Fog Lights*

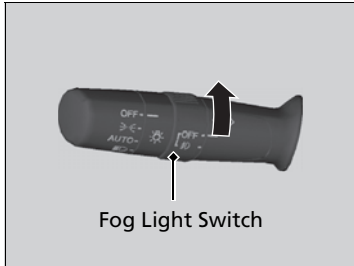

When the headlights are on, turn the fog light switch on to use the fog lights.

☒ Fog Lights*

When the fog lights are on, the indicator in the instrument panel will be on. They go off when the headlights turn off, or when the daytime running lights are on.

➤ **Indicators** P. 74

* Not available on all models

Daytime Running Lights

The daytime running lights come on when the following conditions have been met:

- The power mode is in ON.
- The headlight switch is off.
- The parking brake is released.

The daytime running lights are off once the headlight switch is turned on, or when the head light switch is in **AUTO** and it is getting darker outside.

Auto High-Beam (High Beam Support System)*

Uses the camera attached, monitors the space ahead of your vehicle, and automatically changes the low beam headlights to high beam headlights when necessary.

The system operates when:

- The headlight switch is in **AUTO**.
- The lever is in the low beam position.
- The system recognizes that you are driving at night and the low beam headlights come on.
- The vehicle speed is above 25 mph (40 km/h).

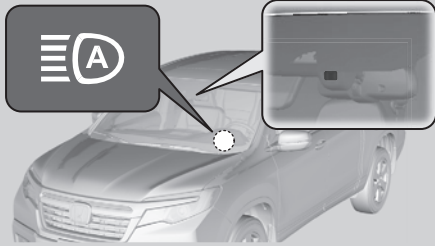

The system changes between high and low beam headlights when:

The camera is not detecting any lights coming from preceding or oncoming vehicles: The headlights change to high beams.

The camera detects lights coming from a preceding or oncoming vehicle: The headlights are returned to low beams.

The camera monitors the range within the 30-degree view angle. The distance that the camera can detect lights ahead differs depending on conditions, such as the brightness of the lights and the weather.

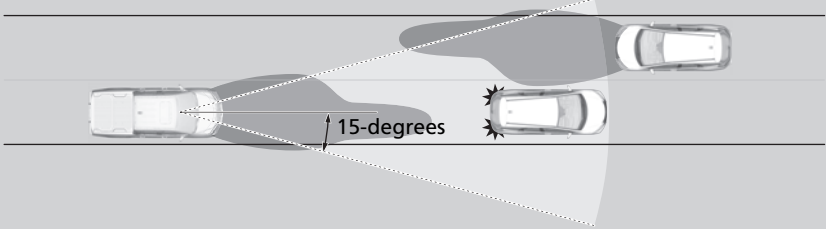

Auto High-Beam (High Beam Support System)*

The auto high-beam determines when to change the headlight beams by responding to the brightness of the lights ahead of your vehicle. In the following cases, the system may not respond to the lights properly:

- The brightness of the lights from the preceding or oncoming vehicle is intense or poor.
- Visibility is poor due to the weather (rain, snow, fog, windshield frost, etc.).
- Other light sources, such as streetlights and electric billboards are illuminating the road ahead.
- The brightness level of the road ahead constantly changes.
- The road is bumpy or with many curves.
- A vehicle cuts in front of you, or a vehicle in front of you is not in the preceding or oncoming direction.
- Your vehicle is tilted with a heavy load in the rear.

If you find the timing of beam changes inconvenient for driving, change the headlight beams manually.

* Not available on all models

Continued

■ To Operate the System



Turn the headlight switch in **AUTO** and pull the headlight lever to low beam.

➤ **Light Switches** P. 146

The auto high-beam indicator comes on.

■ Temporary cancellation

The auto high-beam system operation is temporarily canceled while:

- You are continuously driving at a speed below 15 mph (24 km/h).
- The vehicle speed is below 6 mph (10 km/h).
- The windshield wipers run at high speed for more than a few seconds.

The system operation resumes once the condition that caused it to cancel improves.

▶▶ Auto High-Beam (High Beam Support System)*

For the auto high-beam to work properly:

- Do not place an object that reflects light on the dashboard.
- Keep the windshield around the camera clean. When cleaning the windshield, be careful not to apply the windshield cleanser to the camera lens.
- Do not attach an object, sticker or film to the area around the camera.
- Do not touch the camera lens.

If the camera receives a strong impact, or repairing of the area near the camera is required, consult a dealer.

To help reduce the likelihood that high interior temperatures will cause the camera system to shut off, when parking, find a shady area or face the front of the vehicle away from the sun. If you use a reflective sun shade, do not allow it to cover the camera housing. Covering the camera can concentrate heat on the camera.

■ To manually cancel the system temporarily

You can cancel the operation when you manually change the headlights to high beams. Push the lever forward until you hear a click, or lightly pull the lever towards you to flash high beams. The auto high-beam indicator goes off.

If you want the auto high-beam operation to resume at once, pull the lever towards you.

■ To Disable the System

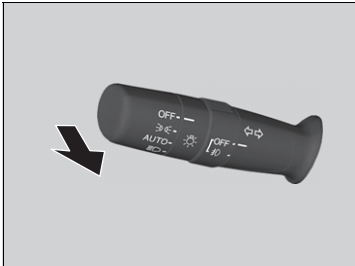

Disable the system when the vehicle is parked with the power mode is in ON and the light switch is in the **AUTO** position.

To disable the system: Pull the light switch lever towards you and hold it for 40 seconds. The auto high-beam indicator in the meter will blink twice.

To enable the system: Pull the light switch lever towards you and hold it for 30 seconds. The auto high-beam indicator in the meter will blink once.

ⓘ Auto High-Beam (High Beam Support System)*

If the **Can Not Operate:**  message appears:

- Park your vehicle in a safe place, and clean the windshield. If the message does not disappear after you have cleaned the windshield and driven for a while, have your vehicle checked by a dealer.

ⓘ To Disable the System

The auto high-beam is in the previously selected disabled or enabled setting each time you start the engine.

* Not available on all models

Wipers and Washers

Windshield Wipers/Washers

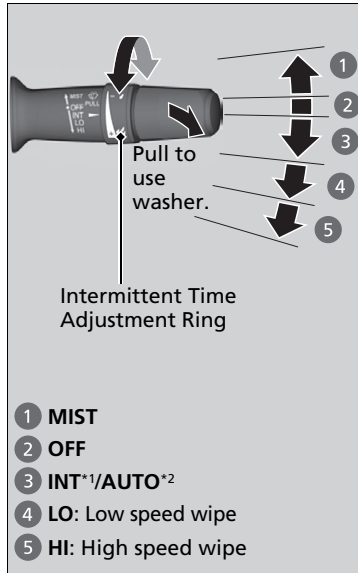

The windshield wipers and washers can be used when the power mode is in ON.

■ MIST

The wipers run at high speed until you release the lever.

■ Wiper switch (OFF, INT*¹/AUTO*², LO, HI)

Move the lever up or down to change the wiper settings.

■ Adjusting wiper operation*

Turn the adjustment ring to adjust wiper operation.



Lower speed, fewer sweeps

Higher speed, more sweeps

■ Washer

Sprays while you pull the lever toward you. When you release the lever for more than one second, the spray stops, the wipers sweep two or three more times to clear the windshield, then stop.

*1 : Models with manual intermittent operation

*2 : Models with automatic intermittent operation

* Not available on all models

Wipers and Washers

NOTICE

Do not use the wipers when the windshield is dry. The windshield will get scratched, or the rubber blades will get damaged.

Turn the washers off if no washer fluid comes out. The pump may get damaged.

The wiper motor may stop motor operation temporarily to prevent an overload. Wiper operation will return to normal within a few minutes, once the circuit has returned to normal.

If the vehicle speeds up while the wipers are operating intermittently, the length of the wipe interval shortens.

When the vehicle speeds up, the wiper operation's shortest delay setting (🕒) and the **LO** setting become the same.

NOTICE

In cold weather, the blades may freeze to the windshield, becoming stuck.

Operating the wipers in this condition may damage the wipers. Use the defroster and heated windshield* to warm the windshield, then turn the wipers on.

If the wipers stop operating due to an obstacle such as the build-up of snow, park the vehicle in a safe place as soon as possible.

Rotate the wiper switch to **OFF**, and set the power mode to ACCESSORY or VEHICLE OFF (LOCK), then remove the obstacle.

Automatic Intermittent Wipers*

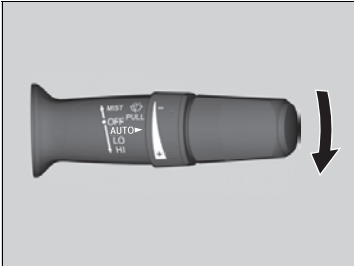

When you push the lever down to **AUTO**, the windshield wipers sweep once, and go into the automatic mode.

The wipers operate intermittently, at low speed, or at high speed and stops in accordance with the amount of rainfall the rainfall sensor detects.

Auto sensitivity adjustment

When the wiper function is set to **AUTO**, you can adjust the sensitivity of the rain fall sensor (using the adjustment ring) so that wipers will operate in accordance with your preference.

Sensor sensitivity

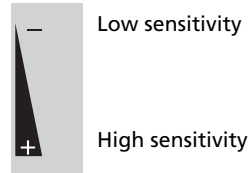

Automatic Intermittent Wipers*

The rainfall sensor is in the location shown below.

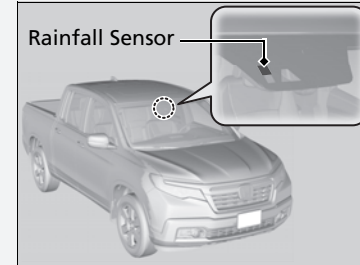

NOTICE

AUTO should always be turned **OFF** before the following situation in order to prevent severe damage to the wiper system:

- Cleaning the windshield
- Driving through a car wash
- No rain present

* Not available on all models

Rear Defogger/Heated Door Mirror* Button

Press the rear defogger and heated door mirror* button to defog the rear window and mirrors when the power mode is in ON.

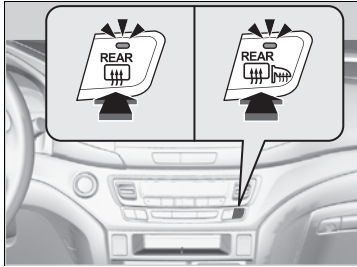

The rear defogger and heated door mirrors* automatically switch off after 10-30 minutes depending on the outside temperature.

►► Rear Defogger/Heated Door Mirror* Button

NOTICE

When cleaning the inside of the rear window, be careful not to damage the heating wires. It is critical to wipe the window from side to side along the defogger heating wires.

This system consumes a lot of power, so turn it off when the window has been defogged or deiced. Also, do not use the system for a long time while the engine is idling. This may weaken the battery, making it difficult to start the engine.

Models with Heated Door Mirror

When the outside temperature is below 41°F (5°C), the heated door mirror may activate automatically for 10 minutes when you set the power mode to ON.

►► Heated Windshield Button

This system activates automatically if the temperature is below 4°C, then deactivates after 15 minutes. After that, the heated windshield button must be pressed to activate the system again for another 15 minutes.

Canadian models

Heated Windshield Button

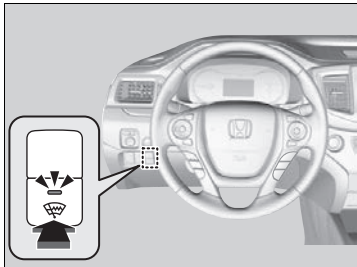

Press the heated windshield button to deice the windshield when the power mode is in ON.

Brightness Control

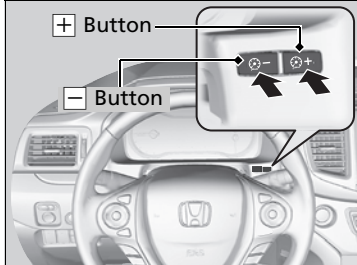

When the power mode is in ON, you can use the **+** or **-** button to adjust instrument panel brightness.

To brighten: Press the **+** button.

To dim: Press the **-** button.

You will hear a beep when the brightness reaches minimum or maximum. Several seconds after you have adjusted the brightness, you will be returned to the previous screen.

■ Brightness level indicator

The brightness level is shown on the multi-information display while you are adjusting it.



▶▶ Brightness Control

Instrument panel brightness varies, depending on whether the exterior lights are on or off. The instrument panel dims to reduce glare when they are on.

If you press the **+** button until the brightness display is up to max, the beeper sounds. This cancels the reduced instrument panel brightness when the exterior lights are on.

The brightness can be set differently for when the exterior lights are on, and when they are off.

Driving Position Memory System*

You can store two driver's seat (except for power lumbar) and door mirror positions with the driving position memory system.

When you unlock and open the driver's door with a remote transmitter or smart entry system, the seat and door mirrors adjust automatically to one of the two preset positions.

When you enter the vehicle, the multi-information display briefly shows you which remote transmitter you used to unlock the vehicle.

- **DRIVER 1** transmitter is linked to memory button 1.
- **DRIVER 2** transmitter is linked to memory button 2.



The driver's seat moves rearward depending on the set seating position once you

- Stop the vehicle.
- Put the transmission in **P**.
- Turn the engine off.
- Then open the driver's door.

Once the power mode is in the ACCESSORY position, the driver's seat moves to the **DRIVER 1** or **2** preset position.

▶▶ Driving Position Memory System*

Using the audio/information screen, you can disable the automatic seat and door mirrors adjustment function.

▶ **Customized Features** P. 317

The driver's seat easy feature can be turned ON/OFF.

▶ **Customized Features** P. 317

System Operation

The system will not operate if:

- The vehicle speed is above 3 mph (5 km/h).
- Either memory position button is pressed while the seat is in motion.
- The seat position is adjusted while in operation.
- The memory 1 or 2 position is set fully to the rear.

To turn the memory position link settings back on, repeat this procedure. The LED will blink once.

■ Storing a Position in Memory

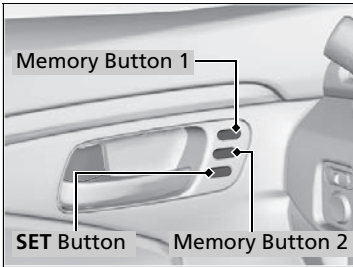

1. Set the power mode to ON. Adjust the driver's seat and door mirrors to the desired position.
2. Press the **SET** button.
 - ▶ You will hear the beeper, and the memory button indicator light will blink.
3. Press and hold memory button **1** or **2** within five seconds of pressing the **SET** button.
 - ▶ Once the seat and the outside mirror positions have been memorized, the indicator light on the button you pressed stays on.

■ Recalling the Stored Position

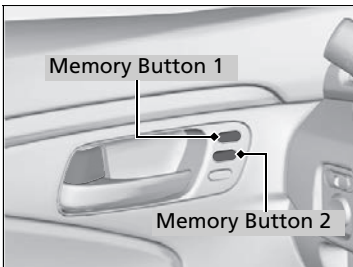

1. Move the shift lever to **P**.
2. Apply the parking brake.
3. Press a memory button (**1** or **2**).
 - ▶ You will hear a beep, and the indicator light will blink.

The seat and the door mirrors will automatically move to the memorized positions. When it has finished moving, you will hear the beeper, and the indicator light stays on.

⊠ Storing a Position in Memory

After you press the **SET** button, the storing operation will be canceled when:

- You do not press the memory button within five seconds.
- You readjust the seat and door mirror position before the double-beep.
- You set the power mode to any position except ON.

⊠ Recalling the Stored Position

The seat and the door mirrors will stop moving if you:

- Press the **SET** button or memory button **1** or **2**.
- Adjust the seat position or door mirrors.
- Shift into a position other than **P**.

Adjusting the Steering Wheel

The steering wheel height and distance from your body can be adjusted so that you can comfortably grip the steering wheel in an appropriate driving posture.

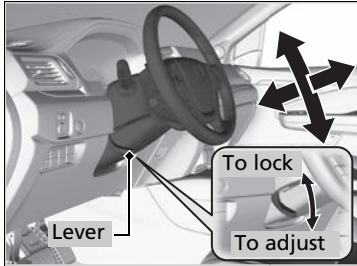

1. Push the steering wheel adjustment lever down.
 - ▶ The steering wheel adjustment lever is under the steering column.
2. Move the steering wheel up or down, and in or out.
 - ▶ Make sure you can see the instrument panel gauges and indicators.
3. Pull the steering wheel adjustment lever up to lock the steering wheel in position.
 - ▶ After adjusting the position, make sure you have securely locked the steering wheel in place by trying to move it up, down, in, and out.

Adjusting the Steering Wheel

CAUTION

Adjusting the steering wheel position while driving may cause you to lose control of the vehicle and be seriously injured in a crash.

Adjust the steering wheel only when the vehicle is stopped.

Make any steering wheel adjustments before you start driving.

Adjusting the Mirrors

Interior Rearview Mirror

Adjust the angle of the rearview mirror when you are sitting in the correct driving position.

Rearview Mirror with Day and Night Positions*

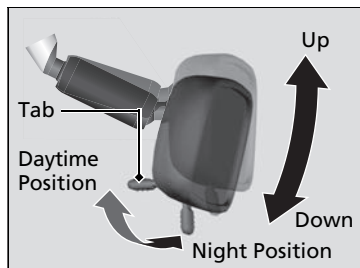

Flip the tab to switch the position. The night position will help to reduce the glare from headlights behind you when driving after dark.

Automatic Dimming Rearview Mirror*

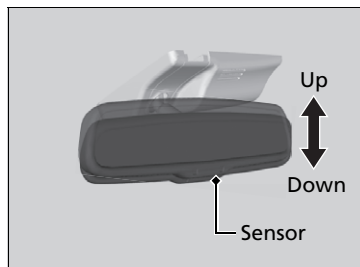

When you are driving after dark, the automatic dimming rearview mirror reduces the glare from headlights behind you, based on inputs from the mirror sensor. This feature is always active.

Adjusting the Mirrors

Keep the inside and outside mirrors clean and adjusted for best visibility.

Adjust the mirrors before you start driving.

➔ **Front Seats** P. 163

Automatic Dimming Rearview Mirror*

The auto dimming function cancels when the shift lever is in **[R]**.

* Not available on all models

Power Door Mirrors

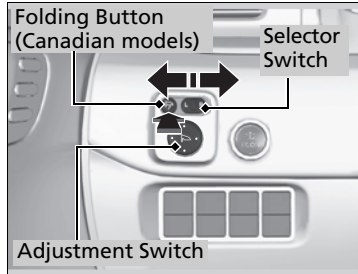

You can adjust the door mirrors when the power mode is in ON.

■ Mirror position adjustment

L/R selector switch: Select the left or right mirror. After adjusting the mirror, return the switch to the center position.

Mirror position adjustment switch: Press the switch left, right, up, or down to move the mirror.

Canadian models

■ Folding door mirrors

Press the folding button to fold in and out the door mirrors.

■ Reverse Tilt Door Mirror*

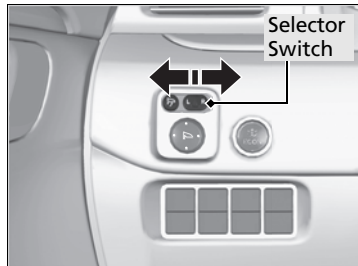

If activated, either side door mirror automatically tilts downward when you put the shift lever into **R**: This improves close-in visibility on the selected side of the vehicle when backing up. The mirror automatically returns to its original position when you shift out of **R**.

To activate this feature, set the power mode to ON, and slide the selector switch to the left or right side.

Adjusting the Seats

Front Seats

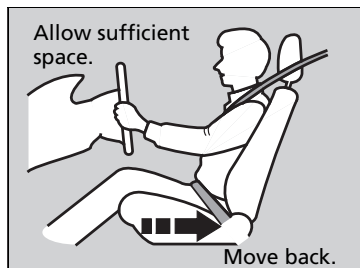

Adjust the driver's seat as far back as possible while allowing you to maintain full control of the vehicle. You should be able to sit upright, well back in the seat and be able to adequately press the pedals without leaning forward, and grip the steering wheel comfortably. The passenger's seat should be adjusted in a similar manner, so that it is as far back from the front airbag in the dashboard as possible.

Adjusting the Seats

⚠ WARNING

Sitting too close to a front airbag can result in serious injury or death if the front airbags inflate.

Always sit as far back from the front airbags as possible while maintaining control of the vehicle.

The National Highway Traffic Safety Administration and Transport Canada recommend that drivers allow at least 10 inches (25 cm) between the center of the steering wheel and the chest.

Always make seat adjustments before driving.

Adjusting the Seat Positions

Adjusting the front power seats*

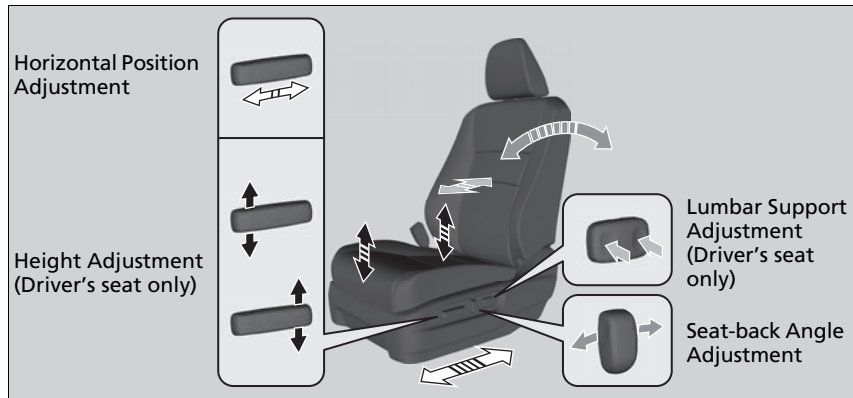

* Not available on all models

Continued

■ Adjusting the front manual seats*

Height Adjustment

(Driver's seat only)

Pull up or push down the lever to raise or lower the seat.

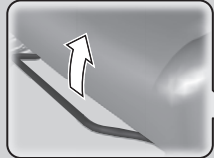

Horizontal Position Adjustment

Pull up on the bar to move the seat, then release the bar.

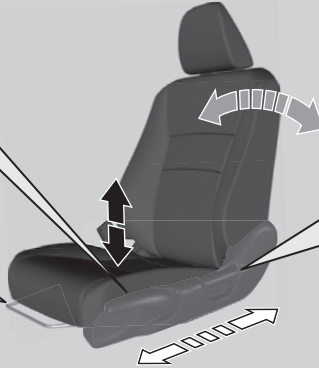

Seat-back Angle Adjustment

Pull up the lever to change the angle.

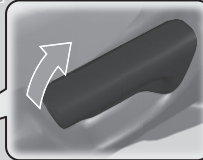

►► Adjusting the front manual seats*

Once a seat is adjusted correctly, rock it back and forth to make sure it is locked in position.

■ Adjusting the Seat-Backs

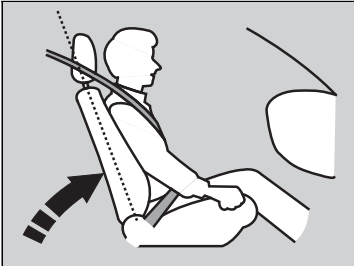

Adjust the driver's seat-back to a comfortable, upright position, leaving ample space between your chest and the airbag cover in the center of the steering wheel.

The front seat passenger should also adjust their seat-back to a comfortable, upright position.

Reclining a seat-back so that the shoulder part of the belt no longer rests against the occupant's chest reduces the protective capability of the belt. It also increases the chance of sliding under the belt in a crash and being seriously injured. The farther a seat-back is reclined, the greater the risk of injury.

▣ Adjusting the Seat-Backs

⚠ WARNING

Reclining the seat-back too far can result in serious injury or death in a crash.

Adjust the seat-back to an upright position, and sit well back in the seat.

Do not put a cushion, or other object, between the seat-back and your back.

Doing so may interfere with proper seat belt or airbag operation.

If you cannot get far enough away from the steering wheel and still reach the controls, we recommend that you investigate whether some type of adaptive equipment may help.

Rear Seats

Folding Up the Rear Seat

The right and left cushions can be raised independently to make room for cargo.

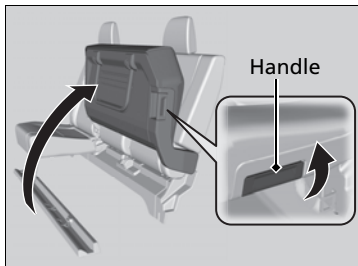

Folding up the rear seat

1. Raise the armrest if it is lowered.
2. Pull the handle and lift up the seat cushion.
3. Release the handle and push the seat cushion firmly against the back support to lock it into place.

► The seat leg automatically retracts as the cushion is raised.

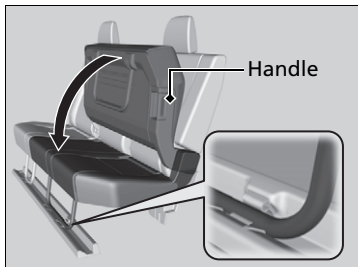

Unfolding the rear seat

1. Hold the seat in its upright position and pull the handle.
► The seat cushion will abruptly drop under its own weight if you do not support it.
2. Slowly lower the cushion until the leg is resting in the floor guide and the cushion is locked into place.

► The seat leg automatically extends out as the cushion is lowered.

Folding Up the Rear Seat

The seat cushion is locked with a mechanism inside the seat.

When the seat is locked, it can not be completely lifted up from the floor without pulling the handle. However, the seat cushion may move up from the floor slightly which is normal. If the seat is in this position, push the seat cushion down before pulling the handle to raise the seat.

Check to make sure there is nothing in the way of the seat cushion or leg before lowering the seat.

The right and left cushions can be raised together or separately to accommodate passengers and cargo.

Maintain a Proper Sitting Position

After all occupants have adjusted their seats and head restraints, and put on their seat belts, it is very important that they continue to sit upright, well back in their seats, with their feet on the floor, until the vehicle is safely parked and the engine is off.

Sitting improperly can increase the chance of injury during a crash. For example, if an occupant slouches, lies down, turns sideways, sits forward, leans forward or sideways, or puts one or both feet up, the chance of injury during a crash is greatly increased.

In addition, an occupant who is out of position in the front seat can be seriously or fatally injured in a crash by striking interior parts of the vehicle or being struck by an inflating front airbag.

ⓘ Maintain a Proper Sitting Position

⚠ WARNING

Sitting improperly or out of position can result in serious injury or death in a crash.

Always sit upright, well back in the seat, with your feet on the floor.

Head Restraints

Your vehicle is equipped with head restraints in all seating positions.

■ Adjusting the front head restraint positions

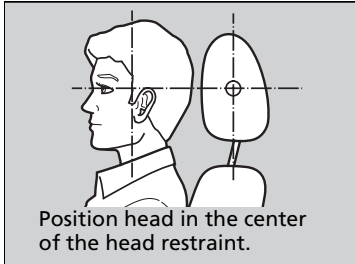

Your vehicle is equipped with head restraints in all seating positions.

Head restraints are most effective for protection against whiplash and other rear-impact crash injuries when the center of the back of the occupant's head rests against the center of the restraint. The tops of the occupant's ears should be level with the center height of the restraint.

To raise the head restraint: Pull it upward.

To lower the head restraint: Push it down while pressing the release button.

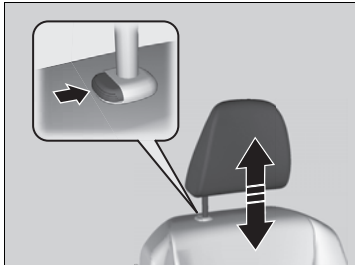

►► Head Restraints

⚠ WARNING

Improperly positioning head restraints reduces their effectiveness and increases the likelihood of serious injury in a crash.

Make sure head restraints are in place and positioned properly before driving.

In order for the head restraint system to work properly:

- Do not hang any items on the head restraints, or from the restraint legs.
- Do not place any objects between an occupant and the seat-back.
- Install each restraint in its proper location.

■ Changing the Rear Seat Head Restraint Position

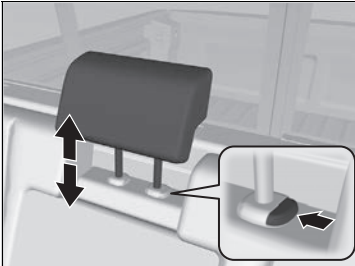

A passenger sitting in the rear seating position should adjust the height of their head restraint to an appropriate position before the vehicle begins moving.

To raise the head restraint:

Pull it upward.

To lower the head restraint:

Push it down while pressing the release button.

■ Removing and Reinstalling the Head Restraints

Head restraints can be removed for cleaning or repair.

To remove a head restraint:

Pull the restraint up as far as it will go. Then push the release button, and pull the restraint up and out.

To reinstall a head restraint:

Insert the legs back in place, then adjust the head restraint to an appropriate height while pressing the release button. Pull up on the restraint to make sure it is locked in position.

☒ Removing and Reinstalling the Head Restraints

⚠ WARNING

Failure to reinstall, or correctly reinstall, the head restraints can result in severe injury during a crash.

Always replace the head restraints before driving.

Armrest

■ Using the Front Seat Armrest



Pull down the armrest.

■ Models with adjustable armrest

Lower the armrest all the way, then pull up to a desired position.

■ Using the Rear Seat Armrest



Pull the armrest down from the center seat back.

Interior Lights

Interior Light Switches

Models without Moonroof

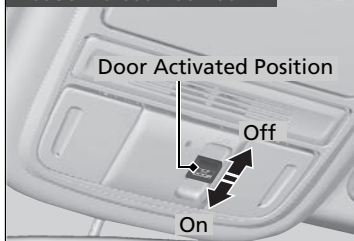

■ ON

The interior lights come on regardless of whether the doors are open or closed.

■ Door activated

The interior lights come on in the following situations:

- When any doors are opened.
- You unlock the driver's door.
- When the power mode is set to VEHICLE OFF (LOCK).

■ OFF

The interior lights remain off regardless of whether the doors are open or closed.

Models with Moonroof

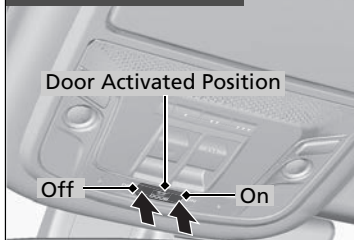

Interior Light Switches

In the door activated position, the interior lights fade out and go off about 30 seconds after the doors are closed.

The lights go off after 30 seconds in the following situations:

- When you unlock the driver's door but do not open it.
- When you set the power mode to VEHICLE OFF (LOCK) but do not open a door.

Models with Display Audio

You can change the interior lights dimming time.

➤ Customized Features P. 317

The interior lights go off immediately in the following situations:

- When you lock the driver's door.
- When you close the driver's door in ACCESSORY mode.
- When you set the power mode to ON.

If you leave any of the doors open in VEHICLE OFF (LOCK) mode, the interior lights go off after about 15 minutes.

Map Lights

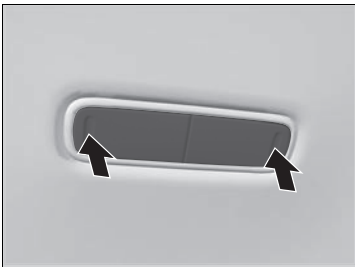
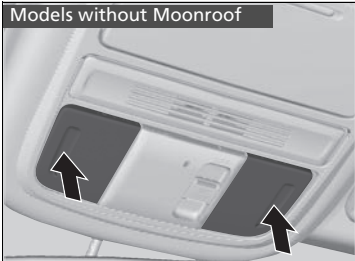

■ Front

The map lights can be turned on and off by pressing the buttons* or lenses*.

■ Rear

The map lights can be turned on and off by pressing the lenses when the front interior light switch is in the door activated position.

»» Map Lights

Models without Moonroof

When the interior light switch is in the door activated position and a door is open, pressing the lens does not turn off the map light.

Interior Convenience Items

■ Glove Box

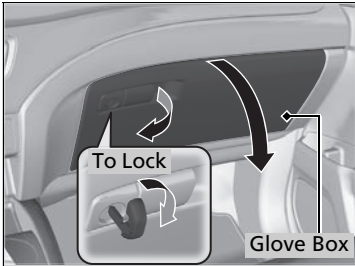

Pull the lever to open the glove box. You can lock the glove box with the built-in key.

☒ Glove Box

⚠ WARNING

An open glove box can cause serious injury to your passenger in a crash, even if the passenger is wearing the seat belt.

Always keep the glove box closed while driving.

■ Console Compartment

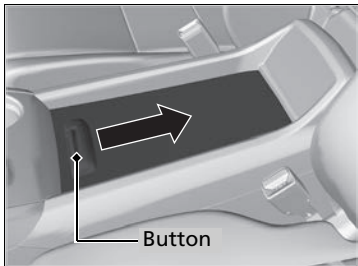

To open the console compartment, press the button to unlock the lid, and then slide it rearward.

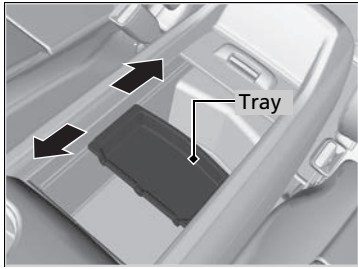

■ **Console Tray**
Slide the tray when you use the console compartment.

■ Beverage Holders



■ Front seat beverage holders

Are located in the console between the front seats.

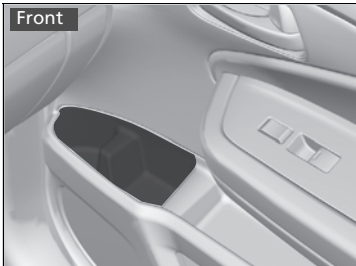

Front

■ Door side beverage holders

Are located on the lower section of each inner door panel.

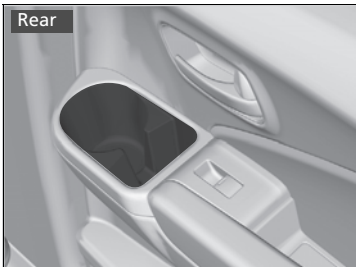

Rear

☒ Beverage Holders

NOTICE

Spilled liquids damage the upholstery, carpeting, and electrical components in the interior.

Be careful when you are using the beverage holders. Hot liquid can scald you.

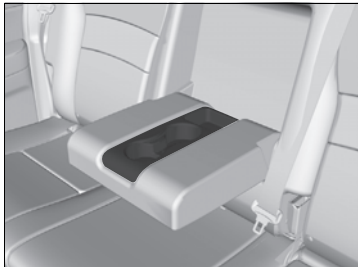

■ **Rear seat beverage holders**

Fold the armrest down to use the rear seat beverage holders.

■ Accessory Power Sockets

The accessory power sockets can be used when the power mode is in ACCESSORY or ON.

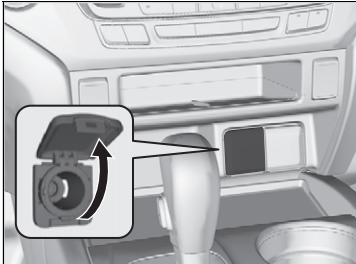

■ Accessory power socket (console panel)

Open the cover to use it.



■ Accessory power socket (console compartment)

Pull the handle and open the cover to use it.

▶▶ Accessory Power Sockets

NOTICE

Do not insert an automotive type cigarette lighter element: The power socket can overheat.

The accessory power socket is designed to supply power for 12-volt DC accessories that are rated 180 watts (15 amps) or less.

To prevent battery drain, use the power socket only when the engine is running.

When both sockets are being used, the combined power rating of the accessories should not exceed 180 watts (15 amps).

■ Coat Hooks



There is a coat hook on the rear grab handle of both sides. Pull it down to use it.

▣ Coat Hooks

The coat hooks are not designed for large or heavy items.

■ Sunglasses Holder

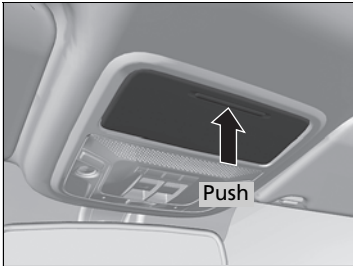

To open the sunglasses holder, push and release the indent. To close, push it again until it latches.

You can store eyeglasses and other small items in this holder.

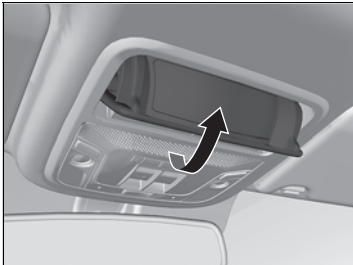

■ Conversation mirror*

The sunglasses holder comes with a mirror. Open the sunglasses holder fully, then push it back to the first detent.

You can use the mirror to view the rear seats.

☒ Sunglasses Holder

Keep the holder closed while driving except when accessing stored items.

* Not available on all models

■ Heated Steering Wheel *

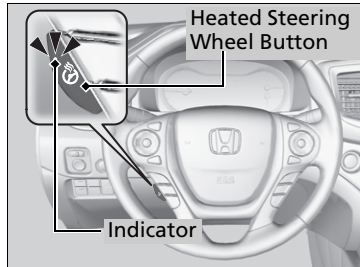

The power mode must be in ON to use the heated steering wheel.

Press the button on the left side of the steering wheel.

When a comfortable temperature is reached, press the button again to turn it off.

The heated steering wheel is turned off every time you start the engine, even if you turned it on the last time you drove the vehicle.

▣ Heated Steering Wheel *

Do not use the heated steering wheel continuously when the engine is off. Under such conditions, the battery may be weakened, making the engine difficult to start.

Front Seat Heaters*



The power mode is in ON to use the seat heaters. The **HI** setting heats the seats faster than the **LO** setting.

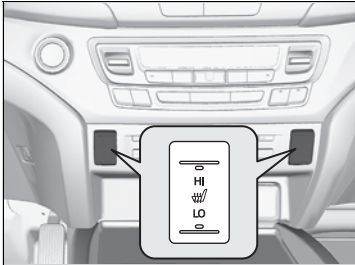

The appropriate indicator will be on while the seat heater is on. For low heat and high heat, press **LO** and **HI** respectively. Center the rocker switch to turn the heater off.

Front Seat Heaters*

⚠ WARNING

Heat induced burns are possible when using seat heaters.

Persons with a diminished ability to sense temperature (e.g., persons with diabetes, lower-limb nerve damage, or paralysis) or with sensitive skin should not use seat heaters.

Do not use the seat heaters even in **LO** when the engine is off. Under such conditions, the battery may be weakened, making the engine difficult to start.

In the **LO** setting, the heater runs continuously and does not automatically turn off.

* Not available on all models

■ Front Seat Heaters and Seat Ventilation*



If the power mode is in ON:

Seat heater - The HI setting heats the seats faster than the LO setting.

Seat ventilation - The HI setting ventilates the seats faster than the LO setting.

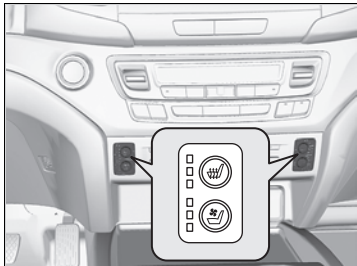

Press the seat heater or the seat ventilation button:

Once - The HI setting (three indicators on)

Twice - The MID setting (two indicators on)

Three times - The LO setting (one indicator on)

Four times - The OFF setting (no indicators on)

When a comfortable temperature is reached while using the seat heaters in HI, select MID or LO to keep the seat warm.

▣ Front Seat Heaters and Seat Ventilation*

⚠ WARNING

Heat induced burns are possible when using seat heaters.

Persons with a diminished ability to sense temperature (e.g., persons with diabetes, lower-limb nerve damage, or paralysis) or with sensitive skin should not use seat heaters.

Do not use the seat heaters and the seat ventilation even in LO when the engine is off. Under such conditions, the battery may be weakened, making the engine difficult to start.

Rear Outer Seat Heaters*

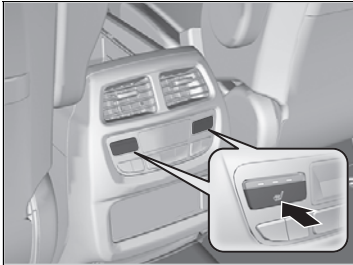

If the power mode is in ON: The HI setting heats the seats faster than the LO setting.

There is no heater in the rear center seating position.

Press the seat heater button:

- Once - The HI setting (three indicators on)
- Twice - The MID setting (two indicators on)
- Three times - The LO setting (one indicator on)
- Four times - The OFF setting (no indicators on)

Once a comfortable temperature has been reached using HI setting, select MID or LO to keep the seat warm.

ⓘ Rear Outer Seat Heaters*

⚠ WARNING

Heat induced burns are possible when using seat heaters.

Persons with a diminished ability to sense temperature (e.g., persons with diabetes, lower-limb nerve damage, or paralysis) or with sensitive skin should not use seat heaters.

Do not use the seat heaters even in LO when the engine is off. Under such conditions, the battery may be weakened, making the engine difficult to start.

* Not available on all models

In-Bed Convenience Items

In-Bed Box

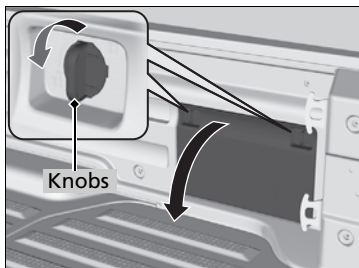

Turn the knobs to the left to open the lid.

AC Power Outlet*

To use the AC power outlet, the power mode must be in ACCESSORY or ON.

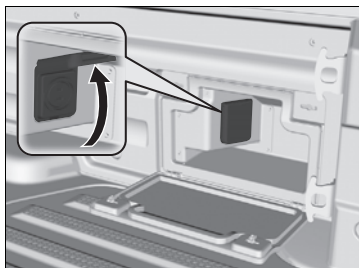

1. Turn the knobs to the left to open the lid.
 ► **In-Bed Box** P. 184
2. Open the cover and plug in the appliance slightly. Turn the plug 90° clockwise, then push it in all the way.

►► AC Power Outlet*

Do not use the AC power outlet for electrical appliances that require high initial peak wattage, such as cathode-ray tube type televisions, refrigerators, electric pumps, etc. It is not suitable for devices that process precise data, such as medical equipment, and that require an extremely stable power supply, such as microcomputer-controlled electric blankets, touch sensor lamps, etc.

The AC power outlet is designed to supply power for up to 115 volt appliances that are rated 400 watts or less.

Continued use of any electrical appliance/device exceeding these ratings may result in damage to the appliance/device.

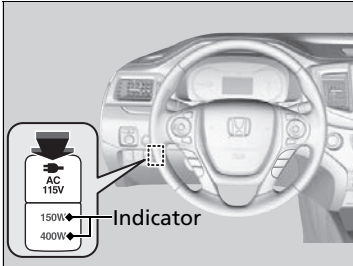

■ ON and OFF

Press the AC power outlet button to turn the system on and off.

- ▶ The indicator in the button comes on when the system is on.

400W (Amber) mode is:

- When the engine running and the shift lever in **[P]**.

150W (Green) mode is:

- When the power mode is in ACCESSORY or ON.
- When the engine running and the shift lever out of **[P]**.
- When the truck bed audio system is activated.

⊠ AC Power Outlet*

The protection circuit may be activated to cut the power supply if any of the following conditions apply:

- The engine is started when the power outlet switch on.
- An electrical appliance exceeding the maximum capacity is used.
- The total power consumed by the electrical features (head lights, air conditioning, etc.), including the truck bed audio*, has exceeded the maximum vehicle wattage capacity for a prolonged period of time.

* Not available on all models

Continued

■ Bed Lights

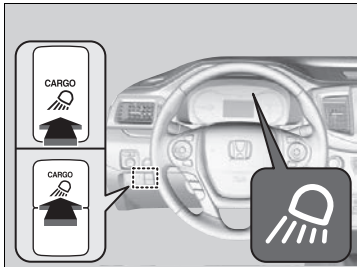

The bed lights can be turned on or off by pressing the button when the shift lever is in **P**.

- The indicator in the meter comes on when the lights are on.

►► Bed Lights

The bed lights comes on when you swing open the tailgate or open the trunk.

If you set the power mode to ACCESSORY or VEHICLE OFF (LOCK) and leave the bed lights on, they will shut off after 30 minutes.

■ Tie-down Anchors

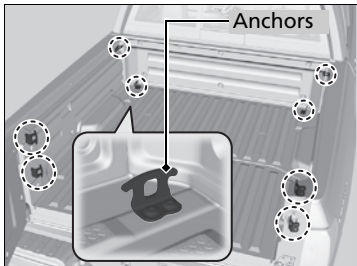

The tie-down anchors on the pickup bed can be used to install a net for securing items.

■ Cargo Hooks

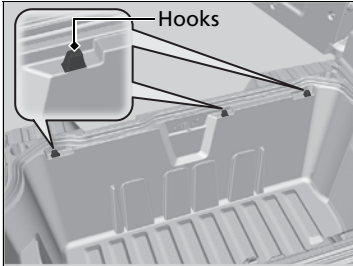

There are three hooks for plastic grocery bags at the back of the trunk. They are designed to hold light items. Heavy objects may damage the hooks.

Using Automatic Climate Control

The automatic climate control system maintains the interior temperature you select. The system also selects the proper mix of heated or cooled air that will as quickly as possible, raise or lower the interior temperature to your preference.

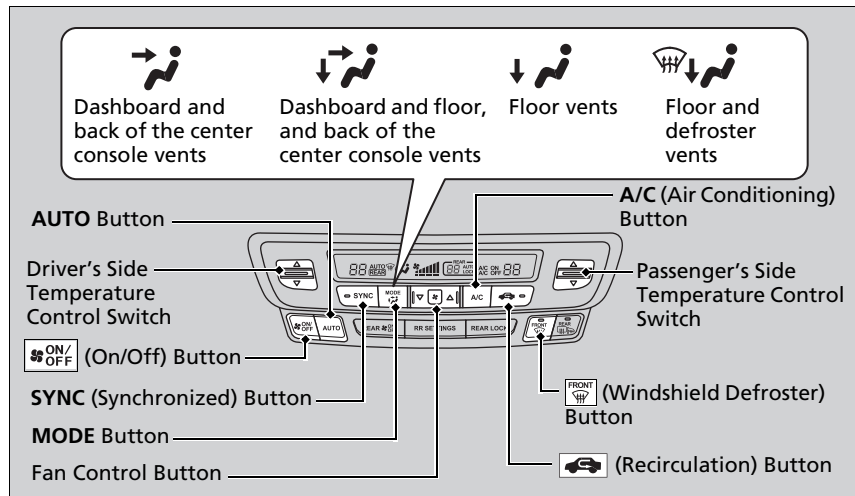

Use the system when the engine is running.

1. Press the **AUTO** button.
2. Adjust the interior temperature using the driver's side or passenger's side temperature control switch.
3. Press the **ON/OFF** button to cancel.

Using Automatic Climate Control

If any buttons are pressed while using the climate control system in auto, the function of the button that was pressed will take priority. The **AUTO** indicator will go off, but functions unrelated to the button that was pressed will be controlled automatically.

If ECON mode is selected, the fan may turn off. To prevent cold air from blowing in from outside, the fan may operate at low speed for a while after the **AUTO** button has been pressed.

Once you have set the desired temperature, do not use the temperature control switches more than necessary.

Doing so may delay the time it takes to reach the set temperature.

If the interior is very warm, you can cool it down more rapidly by partially opening the windows, turning the system on auto, and setting the temperature to low. Change the fresh mode to recirculation mode until the temperature cools down.

When you set the temperature to the lower or upper limit, **Lo** or **Hi** is displayed.

Pressing the **ON/OFF** button switches the climate control system between on and off. When turned on, the system returns to your last selection.

■ Switching between the recirculation and fresh air modes

Press the  button and switch the mode depending on environmental conditions. Recirculation Mode (indicator on): Recirculates air from the vehicle's interior through the system.

Fresh Air Mode (indicator off): Maintains outside ventilation. Keep the system in fresh air mode in normal situations.

■ Defrosting the Windshield and Windows

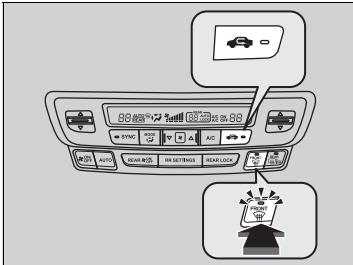

Pressing the  button turns the air conditioner system on and automatically switches the system to fresh air mode.

Press the  button again to turn off, the system returns to the previous settings.

☒ Defrosting the Windshield and Windows

For your safety, make sure you have a clear view through all the windows before driving.

Do not set the temperature near the upper or lower limit.

When cold air hits the windshield, the outside of the windshield may fog up.

If the side windows fog up, adjust the vents so that the air hits the side windows.

■ To rapidly defrost the windows

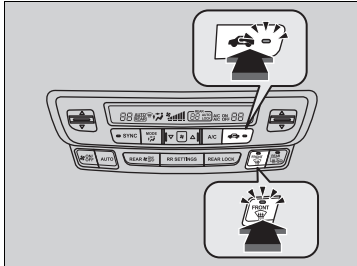

1. Press the  button.
2. Press the  button.

▶▶ To rapidly defrost the windows

After defrosting or defogging the windows, switch over to fresh air mode. If you keep the system in recirculation mode, the windows may fog up from humidity. This impedes visibility.

■ Synchronized Mode

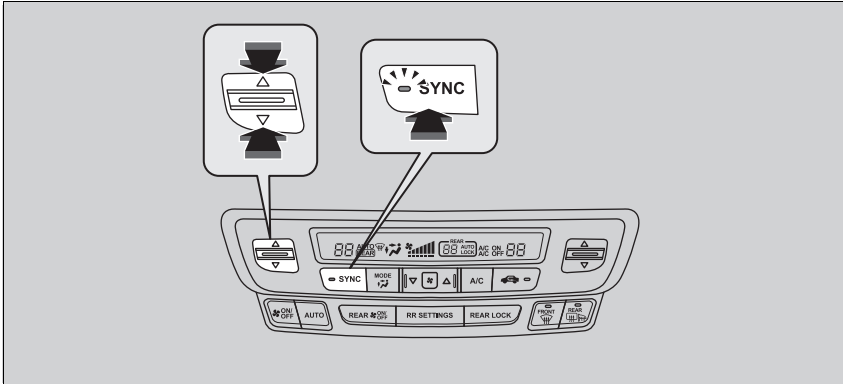

You can set the temperature synchronously for the driver side, front passenger side and rear seats in synchronized mode.

1. Press the **SYNC** button.
 - The system will switch to synchronized mode.
2. Adjust the temperature using driver's side temperature control switch.

Press the **SYNC** button to return to synchronized mode off.

☒ Synchronized Mode

When you press the  button, the system changes to synchronized mode.



When the system is in synchronized mode off, the temperature for the driver, front passenger, and rear seats can be set separately.

Rear Climate Control System

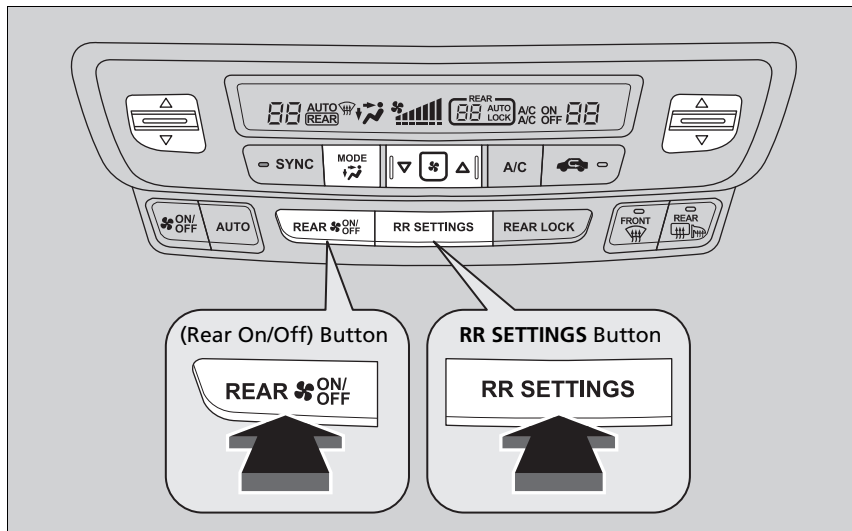
■ Using the Rear Climate Control System From the Front Panel



Use the system when the engine is running and the climate control system is operating.

1. Press the **REAR**  (Rear On/Off) button.
2. Press the **RR SETTINGS** button.
 - The system adjusts the rear climate control system.
3. To turn off the rear climate control system, press the **REAR**  (Rear On/Off) button.

►► Rear Climate Control System

Models with REAR LOCK button

LOCK appears on the rear control panel while the rear lock is on.

If the rear lock is on while in SYNC mode, the rear control panel is disabled. **LOCK SYNC** appears on the rear control panel.

►► Using the Rear Climate Control System From the Front Panel

Models with REAR LOCK button

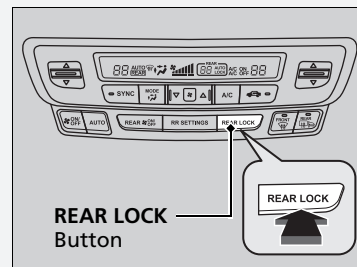

Press the **REAR LOCK** button to turn the rear lock mode on and off.



While the rear lock mode is on, the rear control panel is disabled.

► **REAR LOCK** appears on the display.

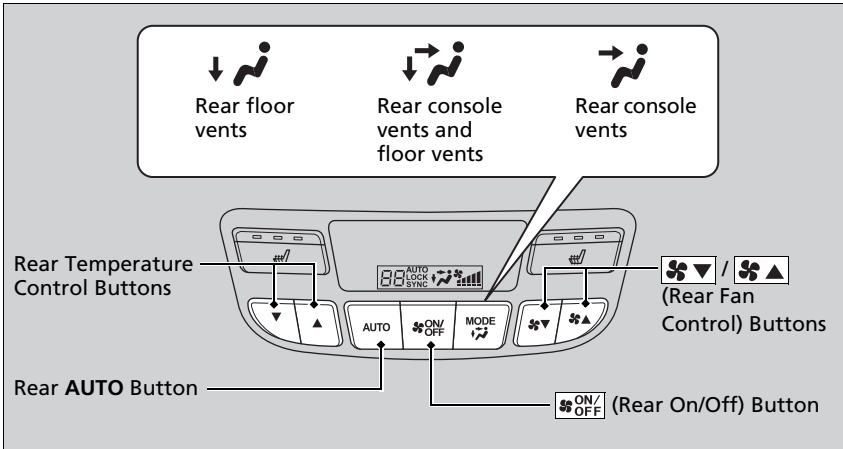
■ Using the Rear Climate Control System From the Rear Panel*



Use the system when the engine is running and the climate control system is operating.

1. Press the  (Rear On/Off) button.
2. Press the Rear **AUTO** button.
3. Adjust the interior temperature using the rear temperature control button.
4. To turn off the rear climate control system, press the  button.

▣ Using the Rear Climate Control System From the Rear Panel*

When the **REAR LOCK** button on the front control panel is off, the temperature of the rear passenger compartment can be controlled independently.

* Not available on all models

Automatic Climate Control Sensors

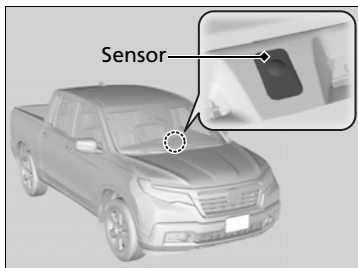

The automatic climate control system is equipped with sensors. Do not cover or spill any liquid on them.

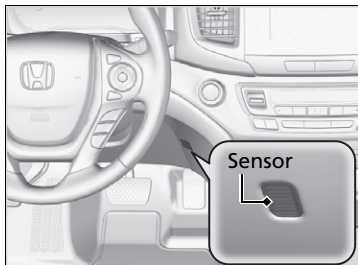

Using Vents, Heating and A/C

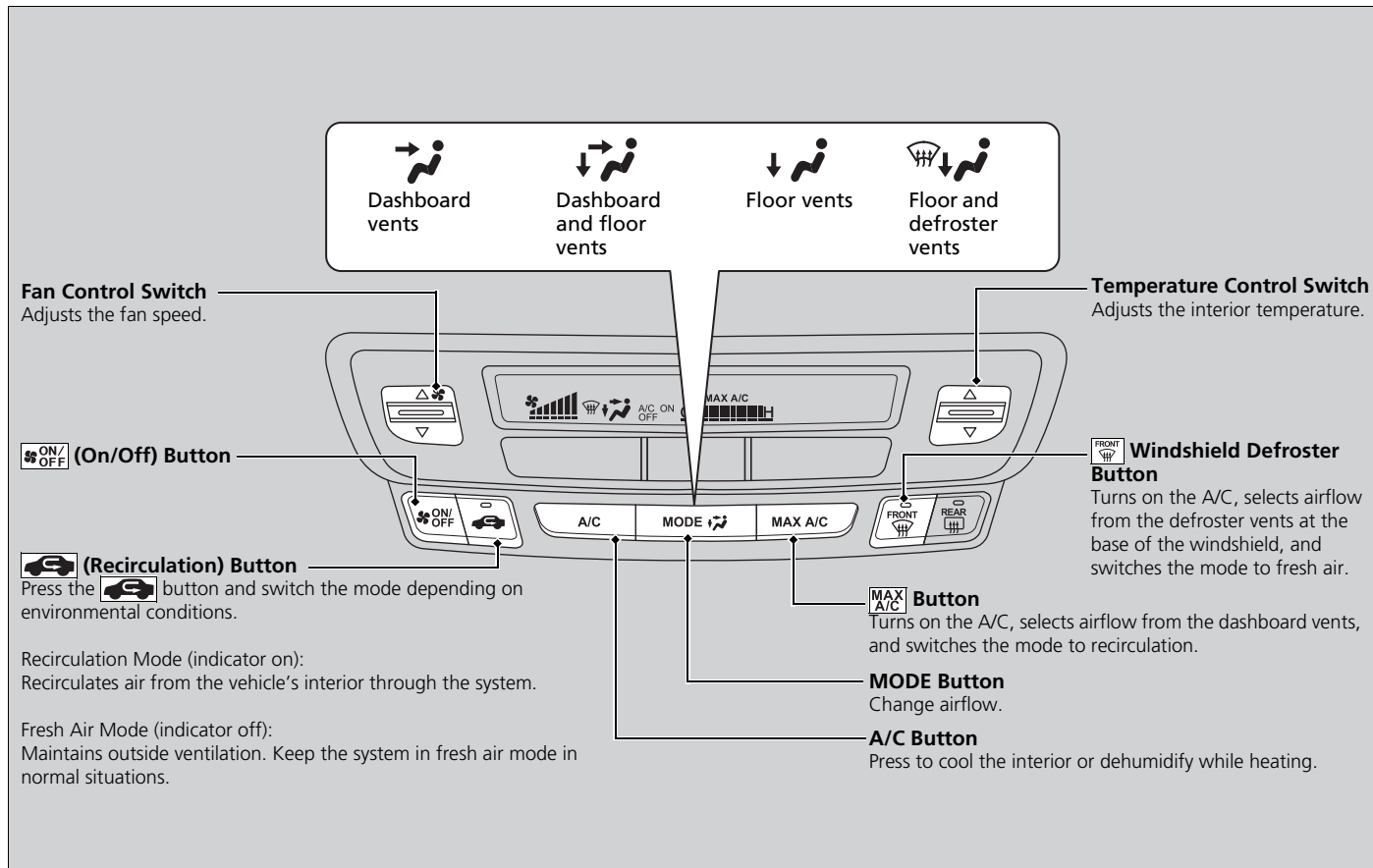

* Not available on all models

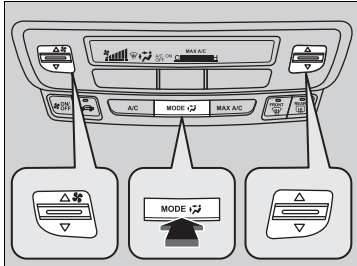

■ Heating



The heater uses heat from the engine coolant to warm the air.

1. Adjust the fan speed using the fan control switch.
2. Press the mode button to select .
3. Adjust the temperature using the temperature control switch.

■ To rapidly warm up the interior

1. Set the fan to the maximum speed.
2. Select .
3. Set the temperature to maximum heat.
4. Press the  button (indicator on).

■ To dehumidify the interior

When used in combination with the heater, the air conditioning system makes the interior warm and dry and can prevent the windows from fogging up.

1. Adjust the fan speed using the fan control switch.
2. Press the **A/C** button to turn on the air conditioning.
3. Select .
4. Adjust the temperature using the temperature control switch.

►► Heating

When you select , the mode automatically switches to fresh air.

►► To rapidly warm up the interior

Change to fresh air mode as soon as the interior gets warm enough. The windows may fog up if kept in recirculation mode.

■ Cooling

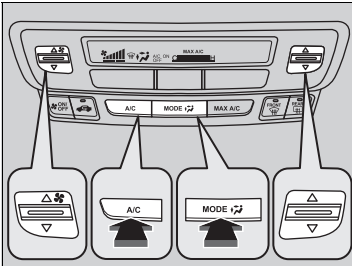

1. Adjust the fan speed using the fan control switch.
2. Press the mode button to select .
3. Adjust the temperature using the temperature control switch.
4. Press the **A/C** button (indicator on).

■ To rapidly cool down the interior

1. Set the fan to the maximum speed.
2. Set the temperature to maximum cool.
3. Press the  button (indicator on).

▣ To rapidly cool down the interior

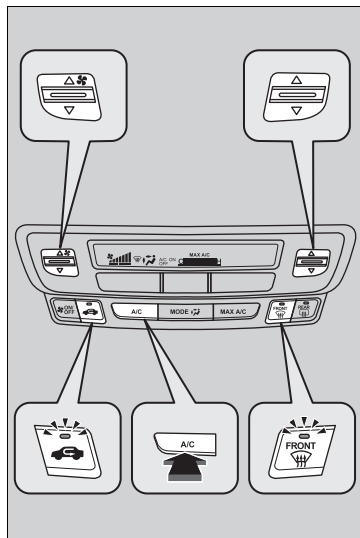

If the interior is very warm, you can cool it down more rapidly by partially opening the windows.

■ Defrosting the Windshield and Windows



Pressing the  button turns the air conditioning system on and automatically switches the system to fresh air mode.

■ To rapidly defrost the windows

1. Set the fan to the maximum speed.
2. Press the  button.
3. Press the  button.
4. Set the temperature to maximum heat.

►► Defrosting the Windshield and Windows

For your safety, make sure you have a clear view through all the windows before driving.

Do not set the temperature near the upper or lower limit.

When cold air hits the windshield, the outside of the windshield may fog up.

If the side windows fog up, adjust the vents so that the air hits the side windows.

►► To rapidly defrost the windows

After defrosting the windows, switch over to fresh air mode.

If you keep the system in recirculation mode, the windows may fog up from humidity. This impedes visibility.

Features

This chapter describes how to operate technology features.

Audio System

About Your Audio System	200
USB Port(s)	201
Auxiliary Input Jack	202
Audio System Theft Protection	203
Audio Remote Controls	204
Models with color audio system	
Audio System Basic Operation	206
Audio/Information Screen	207
Adjusting the Sound	211
Display Setup	212
Playing AM/FM Radio	213
Playing an iPod	215
Playing a USB Flash Drive	218
Playing <i>Bluetooth</i> ® Audio	221

Models with Display Audio

Audio System Basic Operation	224
Audio/Information Screen	225
Adjusting the Sound	242
Display Setup	243
Voice Control Operation	245
Playing AM/FM Radio	249
Playing SiriusXM® Radio*	253
Canadian models	
Playing a CD	261
Playing an iPod	264
Models with navigation system	
Song By Voice™ (SBV)	267
U.S. models	
Playing Pandora®	271

Playing a USB Flash Drive	273
Playing <i>Bluetooth</i> ® Audio	276
HondaLink®	278
Wi-Fi Connection	283
Siri Eyes Free	285
Apple CarPlay	286
Android Auto	289
Truck Bed Audio System*	293
Audio Error Messages	294
General Information on the Audio System	298
Customized Features	317
HomeLink® Universal Transceiver*	348
<i>Bluetooth</i>® HandsFreeLink®	351, 376

* Not available on all models

About Your Audio System

The audio system features AM/FM radio and SiriusXM® Radio* service. It can also play audio CDs*, WMA/MP3/AAC files*, USB flash drives, and iPod, iPhone and Bluetooth® devices.

You can operate the audio system from the buttons* and knobs* on the panel, the remote controls on the steering wheel, or the icons on the touchscreen interface*.

About Your Audio System

Video CDs, DVDs, and 3-inch (8-cm) mini CDs are not supported.

iPod, iPhone and iTunes are trademarks of Apple Inc.

State or local laws may prohibit the operation of handheld electronic devices while operating a vehicle.

Models with Display Audio

SiriusXM® Radio* is available on a subscription basis only. For more information on SiriusXM® Radio*, contact a dealer.

General Information on the Audio System
P. 298

SiriusXM® Radio* is available in the United States and Canada, except Hawaii, Alaska, and Puerto Rico.

SiriusXM® is a registered trademark of SiriusXM Radio*, Inc.

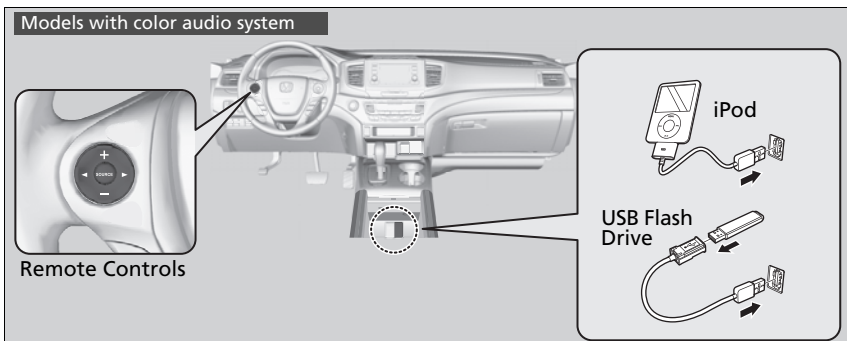
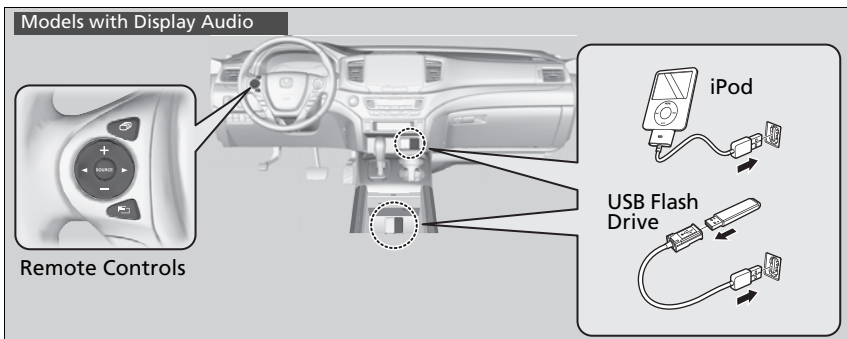

USB Port(s)

Install the iPod USB connector or the USB flash drive to the USB port.

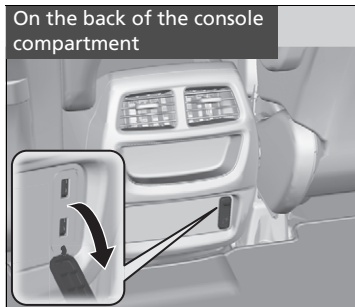
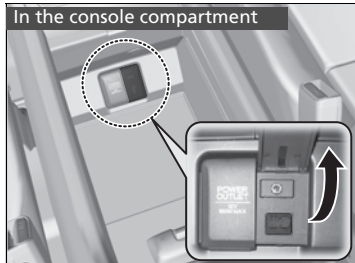
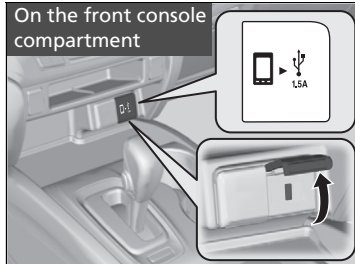

■ On the front console compartment*

The USB port (1.5A) is for charging devices, playing audio files and connecting compatible phones with Apple CarPlay or Android Auto.

■ In the console compartment

The USB port (1.0A) is for playing audio files on a USB flash drive, connecting a mobile phone, and charging devices.

■ On the back of the console compartment*

The USB ports (2.5A) are only for charging devices.

⊠ USB Port(s)

- Do not leave the iPod or USB flash drive in the vehicle. Direct sunlight and high temperatures may damage it.
- We recommend using an extension cable with the USB port.
- Do not connect the iPod or USB flash drive using a hub.
- Do not use a device such as a card reader or hard disk drive, as the device or your files may be damaged.
- We recommend keeping your data backed up before using the device in your vehicle.
- Displayed messages may vary depending on the device model and software version.

If the audio system does not recognize the iPod, try reconnecting it a few times or reboot the device. To reboot, follow the manufacturer's instructions provided with the iPod or visit www.apple.com/ipod.

■ USB charge

The USB port can supply up to 1.0A/1.5A/2.5A of power. It does not output 1.0A/1.5A/2.5A unless the device requests.

For amperage details, read the operating manual of the device that needs to be charged.

Set the power mode to ACCESSORY or ON first.

This port is for battery charge only. You cannot play music even if you have connected a music player to it.

Under certain conditions, a device connected to the port may generate noise in the radio you are listening to.

* Not available on all models

Auxiliary Input Jack



Use the jack to connect standard audio devices.

1. Open the **AUX** cover.
2. Connect a standard audio device to the input jack using a 1/8 inch (3.5 mm) stereo miniplug.
 - ▶ The audio system automatically switches to the AUX mode.

▶▶ Auxiliary Input Jack

Models with color audio system

You can return to AUX mode by pressing the **CD/AUX** button.

Models with Display Audio

You can return to AUX mode by selecting **SOURCE** on the audio screen.

You cannot use the auxiliary input jack if you replace the audio system.

Audio System Theft Protection

The audio system is disabled when it is disconnected from the power source, such as when the battery is disconnected or goes dead. In certain conditions, the system may display a code entry screen. If this occurs, reactivate the audio system.

■ Reactivating the audio system

1. Set the power mode to ON.
2. Turn on the audio system.
3. Press and hold the audio system power button for more than two seconds.
 - ▶ The audio system is reactivated when the audio control unit establishes a connection with the vehicle control unit. If the control unit fails to recognize the audio unit, you must go to a dealer and have the audio unit checked.

▶▶ Audio System Theft Protection

U.S. models

Find the audio system's security code and serial number label in your owner's manual kit.

We recommend that you write down the serial number in this owner's manual.

Do not store the label in your vehicle. If you lose the label, you must first retrieve the serial number, and then obtain the code.

You can find out about your serial number and security code from a dealer.

Audio Remote Controls

Allow you to operate the audio system while driving.

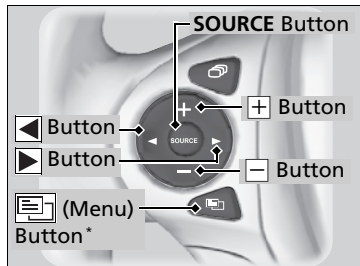

SOURCE Button

Cycles through the audio modes as follows:

Models with color audio system

FM1 → FM2 → AM → USB/iPod → *Bluetooth*[®]
Audio → AUX

Models with Display Audio









FM → AM → SiriusXM^{®*} → CD* → USB → iPod →
Pandora^{®*} → *Bluetooth*[®] Audio → AUX

+ - (Volume) Buttons

Press : To increase the volume.

Press : To decrease the volume.

◀ ▶ Buttons

- When listening to the radio
 - Press** : To select the next preset radio station.
 - Press** : To select the previous preset radio station.
 - Press and hold** : To select the next strong station.
 - Press and hold** : To select the previous strong station.
- When listening to a CD*, iPod, USB flash drive, or *Bluetooth*[®] Audio
 - Press** : To skip to the next song.
 - Press** : To go back to the beginning of the current or previous song.
- When listening to a CD (MP3/WMA/AAC)*, USB flash drive, or *Bluetooth*[®] Audio
 - Press and hold** : To skip to the next folder.
 - Press and hold** : To go back to the previous folder.







▶▶ Audio Remote Controls

Some modes appear only when an appropriate device or medium is used.

Depending on the *Bluetooth*[®] device you connect, some functions may not be operated.

Models with Display Audio

Steering Wheel  (Menu) Button

- When listening to the radio
Press : To display the menu items. You can select **Scan, Save Preset,** or **Seek.**
- When listening to the HD Radio™*
Press : To display the menu items. You can select **Scan, Save Preset,** or **Seek.**
- When listening to the SiriusXM®*
Press : To display the menu items. You can select **Scan, Save Preset, Channel,** or **Category.**
- When listening to a CD* or USB flash drive
Press : To display the menu items. You can select **Scan, Repeat,** or **Random.**
- When listening to an iPod
Press : To display the menu items. You can select **Repeat** or **Shuffle.**
- When listening to a *Bluetooth*® Audio
Press : To display the menu items. You can select **Pause** or **Play.**
- When listening to a Pandora®*
Press : To display the menu items. You can select **Bookmark,** or **Play/Pause.**

* Not available on all models

▶▶ Audio Remote Controls

Models with Display Audio

The  button is available only when the audio mode is FM, AM, SiriusXM®*, CD*, USB, iPod, Pandora®*, or *Bluetooth*® Audio.

Audio System Basic Operation

Models with color audio system

To use the audio system, the power mode must be in ACCESSORY or ON.

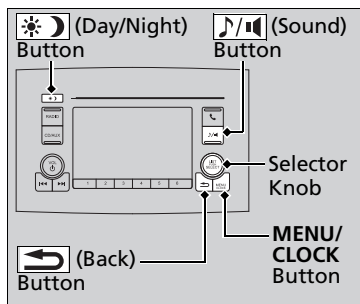

Use the selector knob or **MENU/CLOCK** button to access some audio functions.

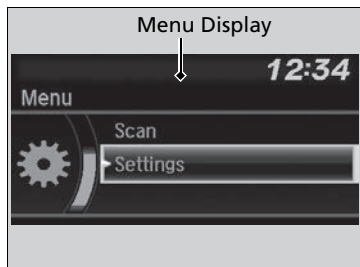

Selector knob: Rotate left or right to scroll through the available choices. Press to set your selection.

MENU/CLOCK button: Press to select any mode.

The available modes include the wallpaper, display, clock, language setup, and play modes. Play modes can be also selected from scan, random, repeat, and so on.

(Back) button: Press to go back to the previous display.

(Sound) button: Press to select the sound setting mode.

(Day/Night) button: Press to change the audio/information screen brightness.

Press , then adjust the brightness using .

- ▶ Each time you press , the mode switches between the daytime mode, nighttime mode and **OFF** mode.

Audio System Basic Operation

These indications are used to show how to operate the selector knob.

Rotate to select.

Press to enter.

Menu Items

- Wallpaper Setup** P. 209
- Display Setup** P. 212
- Scan** P. 214, 220
- Play Mode** P. 217, 220
- RDS Settings** P. 214

One of the operating systems used in this unit is eCos.

For software license terms and condition, visit their website (eCos license URL:

<http://ecos.sourceforge.org/license-overview.html>)

For source code disclosure and other details regarding eCos, visit:

<http://www.hondaopensource2.com>

Press the **SOURCE**, , , or button on the steering wheel to change any audio setting.

- Audio Remote Controls** P. 204

Audio/Information Screen

Displays the audio status and wallpaper. From this screen, you can go to various setup options.

Switching the Display

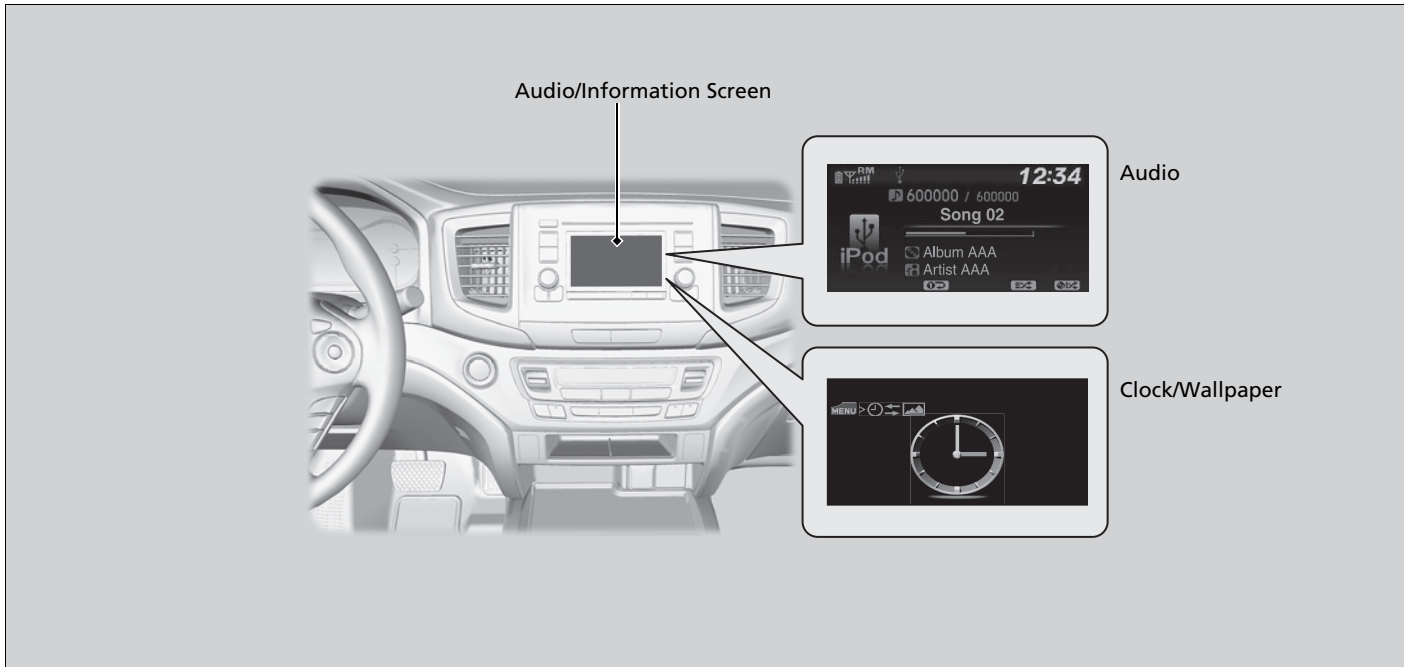







■ Audio

Shows the current audio information.

■ Clock/Wallpaper

Shows a clock screen or an image you import.

■ Change display

1. Press the **MENU/CLOCK** button.
2. Rotate  to select **Settings**, then press .
3. Rotate  to select **Display Change**, then press .
4. Rotate  to select **Wallpaper**, then press .
 - ▶ If you want to return to the audio/information screen, select **Audio**.

Wallpaper Setup

You can change, store, and delete the wallpaper on the audio/information screen.

Import wallpaper

You can import up to three images, one at a time, for wallpaper from a USB flash drive.

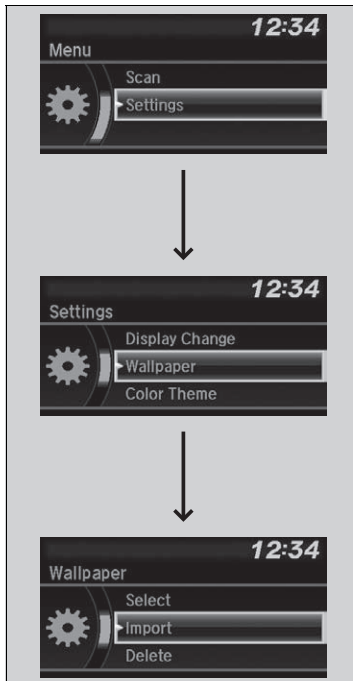









1. Connect the USB flash drive to the USB port.
▶ **USB Port(s)** P. 201
2. Press the **MENU/CLOCK** button.
3. Rotate to select **Settings**, then press .
4. Rotate to select **Wallpaper**, then press .
5. Rotate to select **Import**, then press .
▶ The picture name is displayed on the list.
6. Rotate to select a desired picture, then press .
▶ The selected picture is displayed.
7. Press to save the picture.
8. Press to select **OK**.
9. Rotate to select a location to save the picture, then press .
▶ The display will return to the wallpaper setting screen.

Wallpaper Setup









- When importing wallpaper files, the image must be in the USB flash drive's root directory. Images in a folder cannot be imported.
- The file name must be fewer than 64 characters.
- The file format of the image that can be imported is BMP (bmp) or JPEG (jpg).
- The individual file size limit is 2 MB.
- The maximum image size is 1,920 x 936 pixels. If the image size is less than 480 x 234 pixels, the image is displayed in the middle of the screen with the extra area appearing in black.
- Up to 255 files can be selected.
- If the USB flash drive does not have any pictures, the **No compatible images were found. See Owner's Manual.** message appears.

Continued











■ Select wallpaper

1. Press the **MENU/CLOCK** button.
2. Rotate  to select **Settings**, then press .
3. Rotate  to select **Wallpaper**, then press .
4. Rotate  to select **Select**, then press 
 - ▶ The screen changes to the wallpaper list.
5. Rotate  to select a desired wallpaper, then press .

■ To view wallpaper once it is set

1. Press the **MENU/CLOCK** button.
2. Rotate  to select **Settings**, then press .
3. Rotate  to select **Display Change**, then press .
4. Rotate  to select **Wallpaper**, then press 
 - ▶ The screen changes to the wallpaper list.
5. Rotate  to select a wallpaper that you want to set, then press .

■ Delete wallpaper

1. Press the **MENU/CLOCK** button.
2. Rotate  to select **Settings**, then press .
3. Rotate  to select **Wallpaper**, then press .
4. Rotate  to select **Delete**, then press 
 - ▶ The screen changes to the wallpaper list.
5. Rotate  to select a wallpaper that you want to delete, then press .
6. Rotate  to select **Yes**, then press 
 - ▶ The display will return to the wallpaper setting screen.

▶▶ Wallpaper Setup

To go back to the previous screen, press the  (Back) button.

When the file size is large, it takes a while to be previewed.

Adjusting the Sound

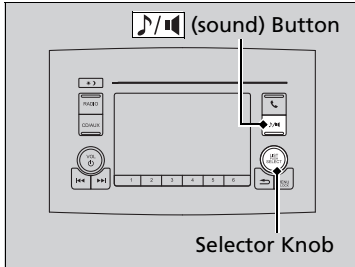

Press the (sound) button, and rotate to scroll through the following choices:

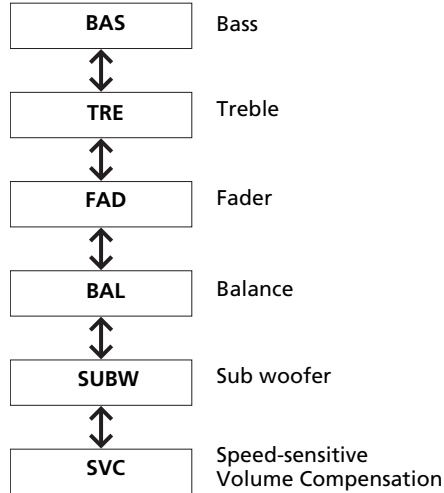
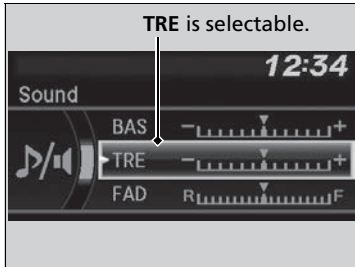

Rotate to adjust the sound setting, then press .

Adjusting the Sound

The SVC has four modes: **Off**, **Low**, **Mid**, and **High**. SVC adjusts the volume level based on the vehicle speed. As you go faster, audio volume increases. As you slow down, audio volume decreases.

Display Setup

You can change the brightness or color theme of the audio/information screen.

■ Changing the Screen Brightness

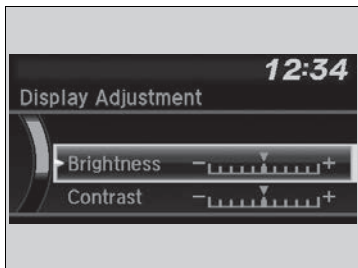

1. Press the **MENU/CLOCK** button.
2. Rotate to select **Settings**, then press .
3. Rotate to select **Display Adjustment**, then press .
4. Rotate to select **Brightness**, then press .
5. Rotate to adjust the setting, then press .

■ Changing the Screen's Color Theme

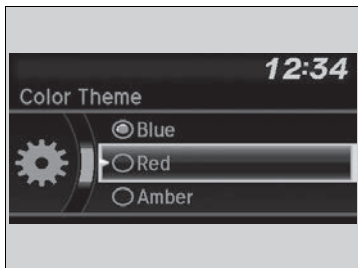

1. Press the **MENU/CLOCK** button.
2. Rotate to select **Settings**, then press .
3. Rotate to select **Color Theme**, then press .
4. Rotate to select the setting you want, then press .

▶▶ Changing the Screen Brightness

You can change the **Contrast** and **Black Level** settings in the same manner.

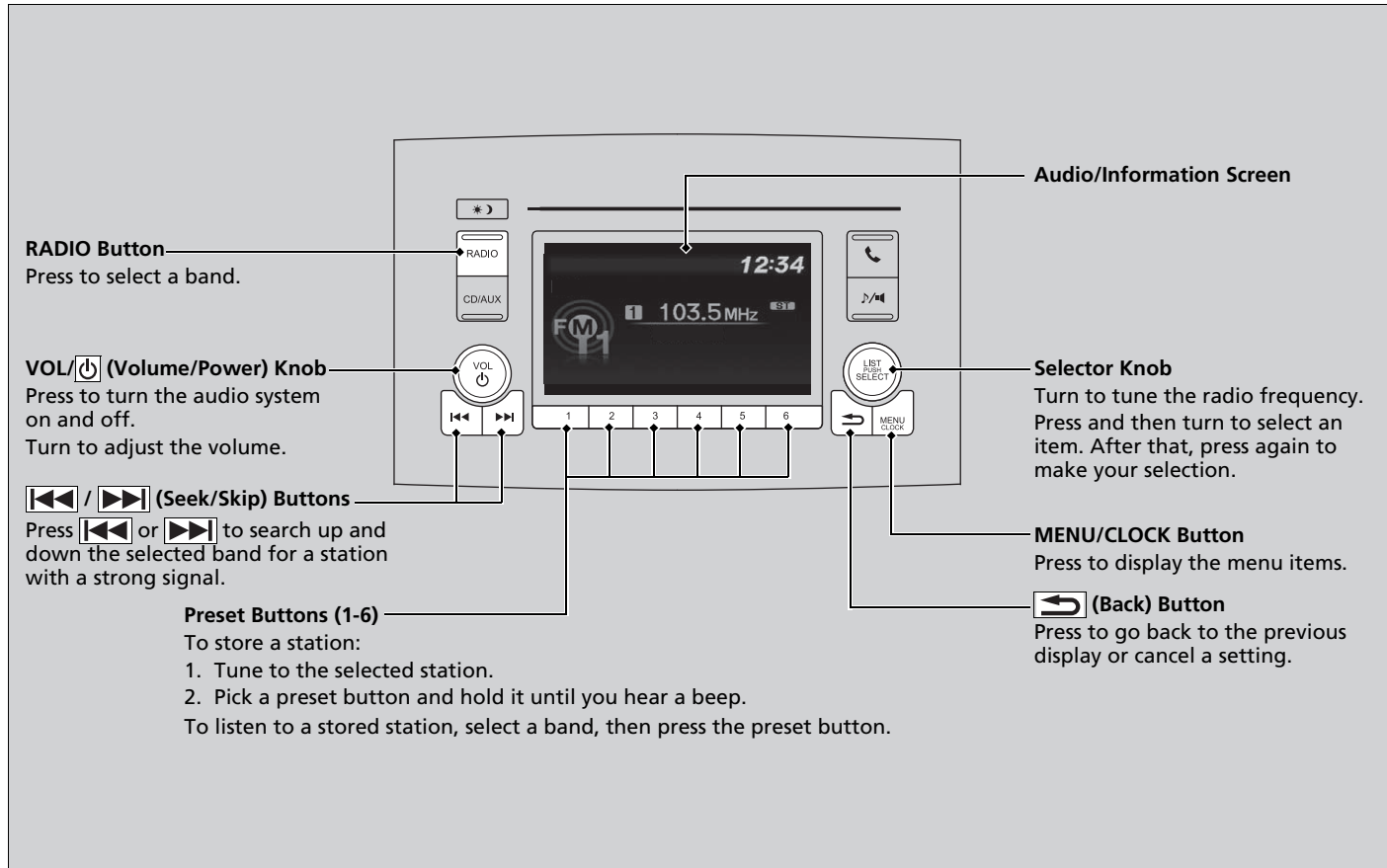

Playing AM/FM Radio



Radio Data System (RDS)

Provides text data information related to your selected RDS capable FM station.

■ To find an RDS station from Station List

1. Press  while listening to an FM station.
2. Rotate  to select the station, then press .

■ Update List

Updates your available station list at any time.

1. Press  while listening to an FM station.
2. Rotate  to select **Update List**, then press .

■ Radio text

Displays the radio text information of the selected RDS station.

1. Press the **MENU/CLOCK** button.
2. Rotate  to select **Settings**, then press .
3. Rotate  to select **RDS Settings**, then press .
4. Rotate  to select **Radio Text**, then press .

■ Scan

Samples each of the strongest stations on the selected band for 10 seconds.

1. Press the **MENU/CLOCK** button.
2. Rotate  to select **Scan**, then press .

To turn off scan, press .

▶▶ Playing AM/FM Radio

The **ST** indicator appears on the display indicating stereo FM broadcasts. Stereo reproduction in AM is not available.

You can store 6 AM stations and 12 FM stations into reset button memory. FM1 and FM2 let you store 6 stations each.

Switching the Audio Mode

Press the **SOURCE** button on the steering wheel.

▶▶ **Audio Remote Controls** P. 204

▶▶ Radio Data System (RDS)

When you select an RDS-capable FM station, the RDS automatically turns on, and the frequency display changes to the station name. However, when the signals of that station become weak, the display changes from the station name to the frequency.

Playing an iPod

Connect the iPod using your dock connector to the USB port, then press the **CD/AUX** button.

 **USB Port(s)** P. 201

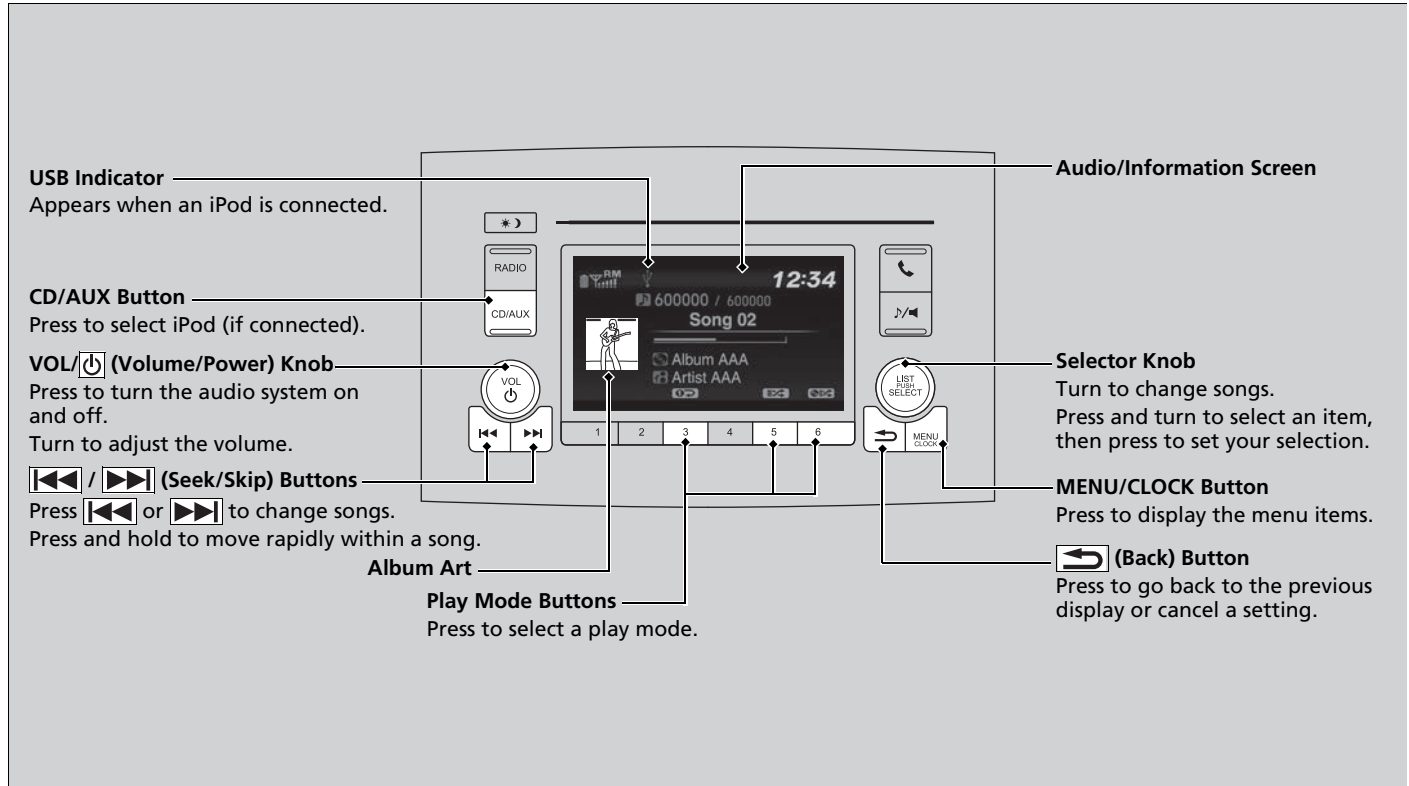

How to Select a Song from the iPod Music List with the Selector Knob

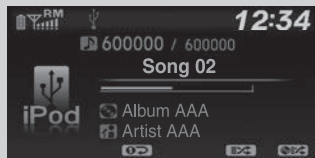

Category Selection

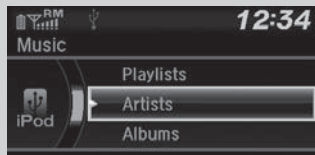



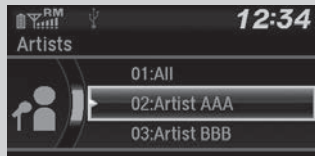

Item Selection



1. Press  to display the iPod music list.

2. Rotate  to select a category.

3. Press  to display a list of items in the category.

4. Rotate  to select an item, then press .
▶ Press  and rotate  repeatedly until a desired item you want to listen to is displayed.

▶▶ Playing an iPod

Available operating functions vary on models or versions. Some functions may not be available on the vehicle's audio system.

If there is a problem, you may see an error message on the audio/information screen.

 **iPod/USB Flash Drive** P. 295

How to Select a Play Mode

You can select repeat and shuffle modes when playing a song.

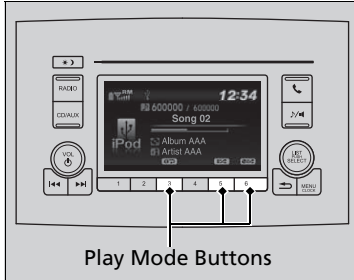

Available mode icons appear above the play mode buttons.

Press the button corresponding to the mode you want to select.

To turn off a play mode

Press the selected button.

How to Select a Play Mode

Play Mode Menu Items



 **Shuffle Albums:** Plays all available albums in a selected category (playlists, artists, albums, songs, genres, or composers) in random order.



 **Shuffle:** Plays all available songs in a selected category (playlists, artists, albums, songs, genres, or composers) in random order.

 **Repeat One Track:** Repeats the current song.

You can also select a play mode by pressing the **MENU/CLOCK** button.

Rotate  to select **Play Mode**, then press .

Rotate  to select a mode, then press .

To turn it off, rotate  to select **Normal Play**, then press .

Playing a USB Flash Drive

Your audio system reads and plays audio files on a USB flash drive in either MP3, WMA or AAC*1 format.

Connect your USB flash drive to the USB port, then press the **CD/AUX** button.

➤ **USB Port(s)** P. 201

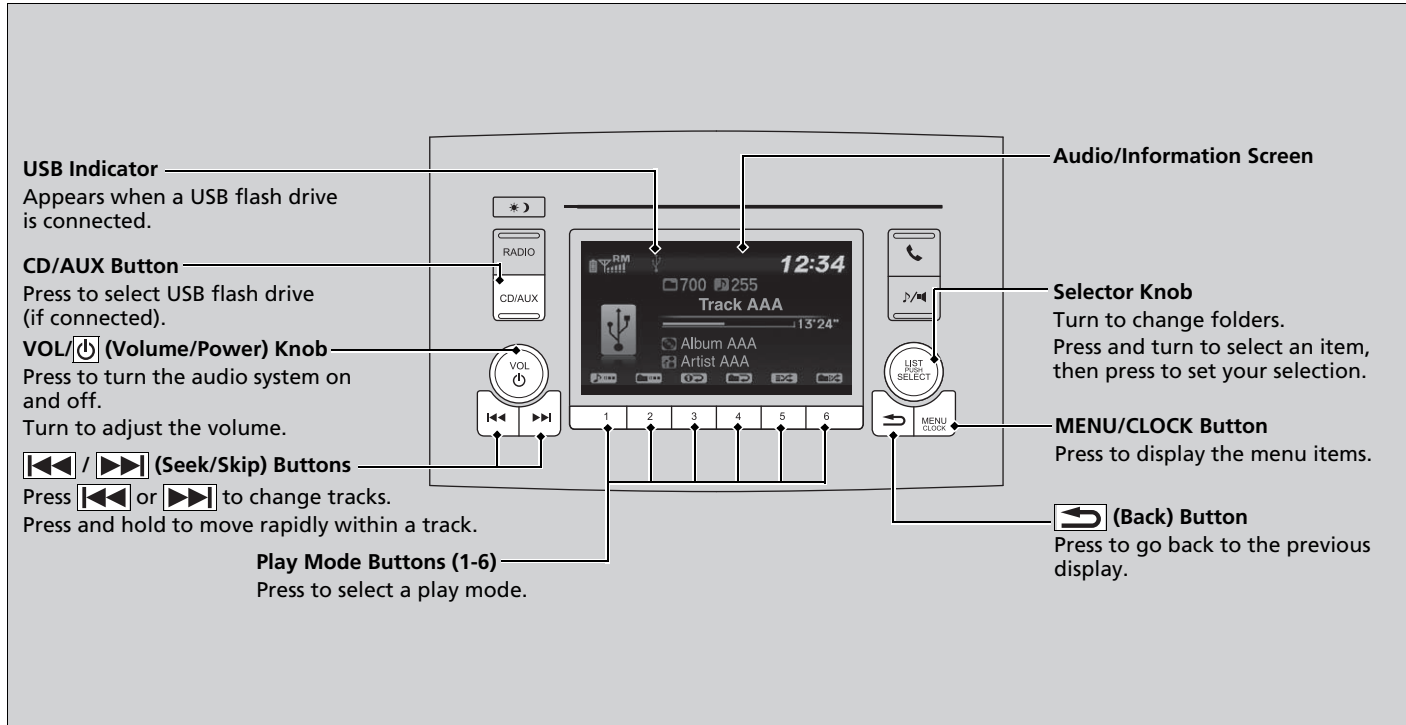

*1: Only AAC format files recorded with iTunes are playable on this unit.

How to Select a File from a Folder with the Selector Knob

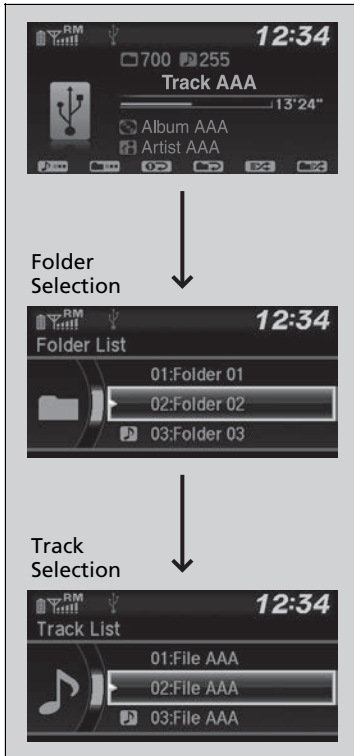

1. Press to display a folder list.

2. Rotate to select a folder.

3. Press to display a list of tracks in that folder.

4. Rotate to select a track, then press .

▶▶ Playing a USB Flash Drive

Use the recommended USB flash drives.

▶ **General Information on the Audio System**
P. 298

Files in WMA format protected by digital rights management (DRM) are not played.

The audio system displays **Unplayable File**, and then skips to the next file.

If there is a problem, you may see an error message on the audio/information screen.

▶ **iPod/USB Flash Drive** P. 295

Continued

■ How to Select a Play Mode

You can select repeat, random, and scan modes when playing a file.

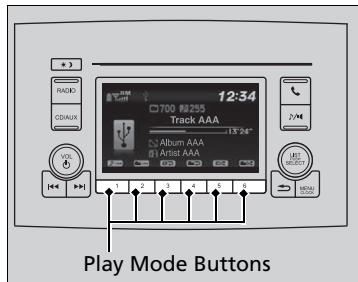

Available mode icons appear above the play mode buttons.

Press the button corresponding to the mode you want to select.

■ To turn off a play mode

Press the selected button.

▶▶ How to Select a Play Mode

Play Mode Menu Items

Repeat

 **Repeat One Folder:** Repeats all files in the current folder.

 **Repeat One Track:** Repeats the current file.

Random

 **Random in Folder:** Plays all files in the current folder in random order.

 **Random All:** Plays all files in random order.



Scan



 **Scan Folders:** Provides 10-second sampling of the first file in each of the main folders.

 **Scan Tracks:** Provides 10-second sampling of all files in the current folder.

You can also select a play mode by pressing the **MENU/CLOCK** button.

Rotate  to select **Play Mode**, then press .

Rotate  to select a mode, then press .

To turn it off, rotate  to select **Normal Play**, then press .

Playing *Bluetooth*® Audio

Your audio system allows you to listen to music from your *Bluetooth*-compatible phone.

This function is available when the phone is paired and connected to the vehicle's *Bluetooth*® HandsFreeLink® (HFL) system.

📌 **Phone Setup** P. 357

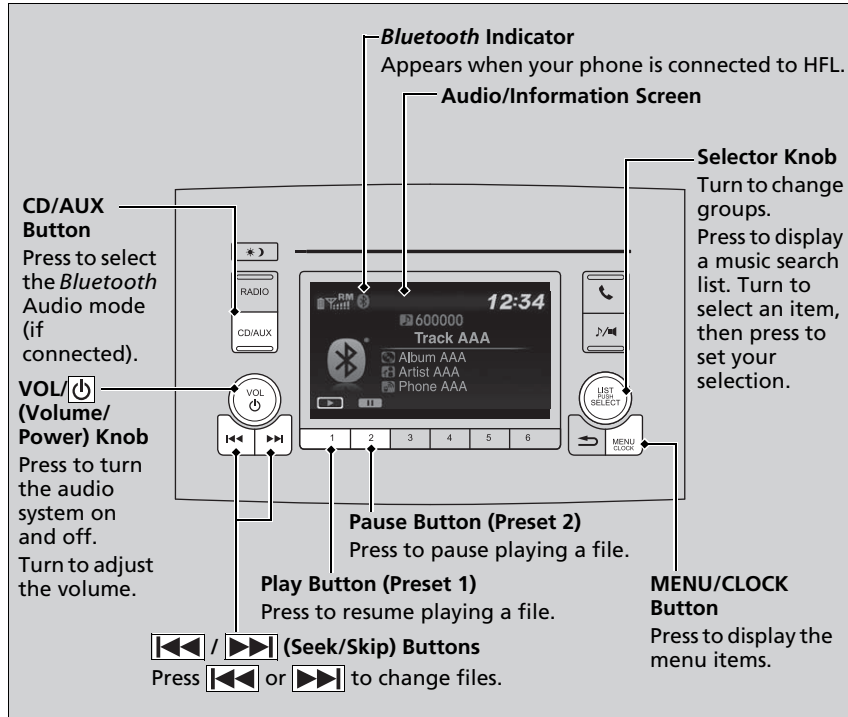

▶▶ Playing *Bluetooth*® Audio

Not all *Bluetooth*-enabled phones with streaming audio capabilities are compatible with the system. For a list of compatible phones:

- U.S.: Visit automobiles.honda.com/handsfreelink/, or call 1-888-528-7876.
- Canada: Visit www.handsfreelink.ca, or call 1-888-528-7876.

In some states, it may be illegal to perform some data device functions while driving.

Only one phone can be used with HFL at a time. When there are more than two paired phones in the vehicle, the first paired phone the system finds is automatically connected.

If more than one phone is paired to the HFL system, there may be a delay before the system begins to play.

In some cases, the name of the artist, album, or track may not appear correctly.

Some functions may not be available on some devices.

■ To Play *Bluetooth*® Audio Files

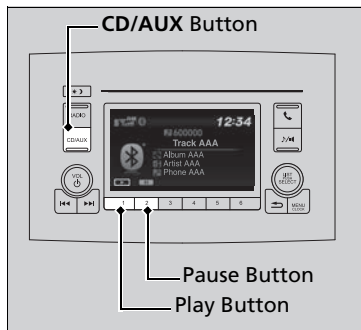

1. Make sure that your phone is paired and connected to HFL.
2. Press the **CD/AUX** button until the *Bluetooth*® Audio mode is selected.

If the phone is not recognized, another HFL-compatible phone, which is not compatible for *Bluetooth*® Audio, may already be connected.

- ### ■ To pause or resume a file
- Press a Play or Pause button to select a mode.

▶▶ To Play *Bluetooth*® Audio Files

To play the audio files, you may need to operate your phone. If so, follow the phone maker's operating instructions.





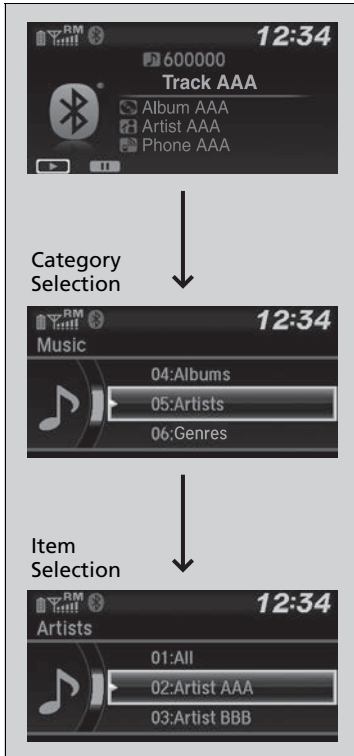

The pause function may not be available on some phones.

If any audio device is connected to the auxiliary input jack or USB port, you may need to press the **CD/AUX** button repeatedly to select the *Bluetooth*® Audio system.

Switching to another mode pauses the music playing from your phone.

How to Select a Song from the Music Search List with the Selector Knob



1. Press  to display the music search list.
2. Rotate  to select a category.
3. Press  to display a list of items in the category.
4. Rotate  to select an item, then press .
 - ▶ Press  and rotate  repeatedly until a desired item you want to listen to is displayed.

How to Select a Song from the Music Search List with the Selector Knob

Depending on the *Bluetooth*® device you connect, some or all of the categories may not be displayed.

Models with Display Audio

To use the audio system function, the power mode must be in ACCESSORY or ON.

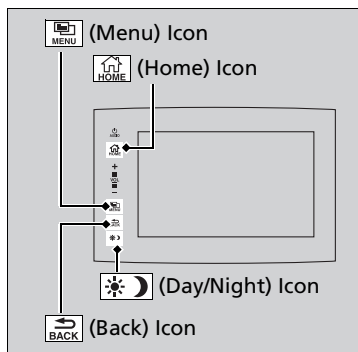

: Select to go to the home screen.

Switching the Display P. 225

: Select to display any mode.

The available modes include **Sound, View Radio Text, Music Search**, and play modes.

: Select to go back to the previous display when it is displayed.

: Select to change the audio/information screen brightness.

Select once and select or to make an adjustment.

▶ Each time you select , the mode switches among the daytime mode, nighttime mode and off mode.

Audio System Basic Operation

Audio Menu Items

- Station List** P. 250, 251
- Music Search List** P. 262, 265, 274
- Scan** P. 251, 260, 263, 275
- Play Mode** P. 263, 266, 275

Audio/Information Screen

Displays the audio status and wallpaper. From this display, you can go to various setup options.

■ Switching the Display

■ Using the button

Press the  (display) button to change the display.

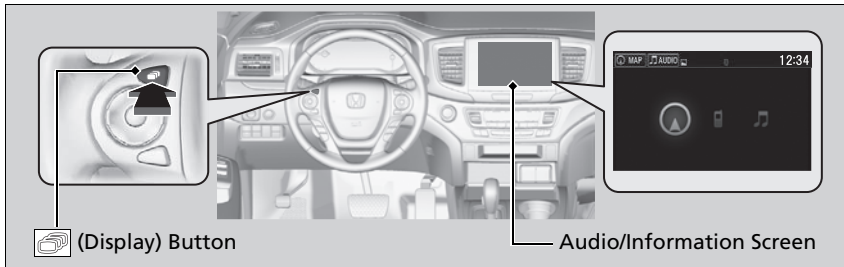

■ Using the audio/information screen

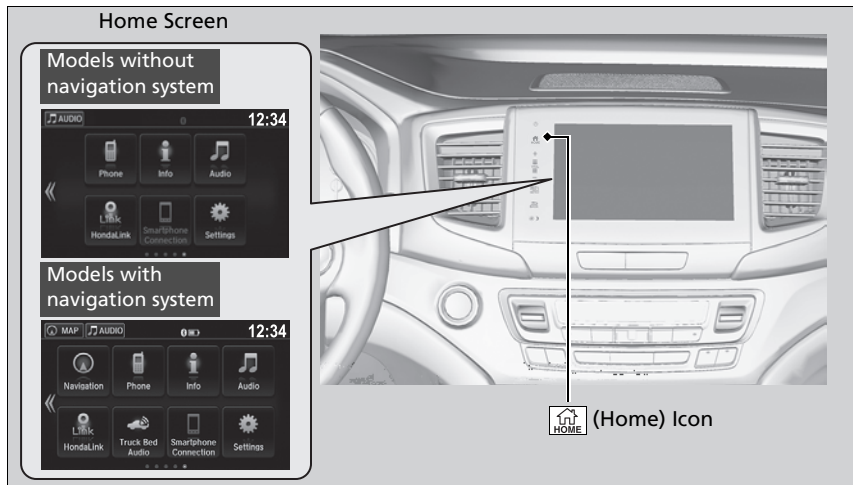

Select  to go to the home screen.

Select **Phone**, **Info**, **Audio**, **Settings**, **Navigation***, **HondaLink**, **Smartphone Connection**, or **Truck Bed Audio***.

■ Phone

Displays the HFL information.

➤ **Bluetooth® HandsFreeLink®** P. 376

▶▶ Using the audio/information screen

Touchscreen Operation

- Use simple gestures - including touching, swiping, and scrolling - to operate certain audio functions.
- Some items may be grayed out during driving to reduce the potential for distraction.
- You can select them when the vehicle is stopped or use voice commands.
- Wearing gloves may limit or prevent touchscreen response.
- You can use the microfiber cleaning cloth included in your owner's kit to remove dust or fingerprints from the touchscreen.

You can change the touchscreen sensitivity setting.

➤ **Customized Features** P. 317

■ Info

Displays **Trip Computer** or **Clock/Wallpaper**. To see all available information, **Trip Computer**, **Voice Info**, **Clock/Wallpaper**, or **System/Device Information**, select



on the **Info Menu** screen.

Trip Computer:

- **Current Drive** tab: Displays the current trip information.
- **History of Trip A** tab: Displays information for the three previous drives. The information is stored every time you reset Trip A.
To delete the history manually, select **Delete History** on the **History of Trip A** tab. The confirmation message appears on the screen, then select **Yes**.

Voice Info: Displays the all commands list.

Clock/Wallpaper: Displays the clock and wallpaper.

System/Device Information:

- **System Info:** Displays the software version of the audio system.
- **USB Info:** Displays the memory usage of the USB device.

■ Audio

Displays the current audio information.

■ Settings

Enters the customizing menu screen.

➤ **Customized Features** P. 323

■ Navigation*

Displays the navigation screen.

➤ **Refer to the Navigation System Manual**

* Not available on all models

■ **HondaLink**

Connects with your smartphone*1 to play personalized music, information, and social media streams.

➤ **HondaLink**® P. 278

■ **Smartphone Connection**

Displays the **Apple CarPlay** or **Android Auto**.

➤ **Apple CarPlay** P. 286

➤ **Android Auto** P. 289

■ **Truck Bed Audio***

Displays the Truck Bed Audio System screen.

➤ **Truck Bed Audio System*** P. 293

*1: Available on specific phones only. Check automobiles.honda.com/handsfreelink/ for U.S. and www.handsfreelink.ca for Canada for compatible phones and hondalink.com for U.S. and honda.ca/hondalink for Canada for feature details.

* Not available on all models

Changing the Home Screen Icon Layout



1. Select .
2. Select and hold an icon.
 - ▶ The screen switches to the customization screen.
3. Drag and drop the icon to where you want it to be.
4. Select **OK**.
 - ▶ The screen will return to the home screen.

Changing the Home Screen Icon Layout

It is not possible to change the position of the  icon.

Wallpaper Setup

You can change, store, and delete the wallpaper on the audio/information screen.

Import wallpaper

You can import up to five images, one at a time, for wallpaper from a USB flash drive.

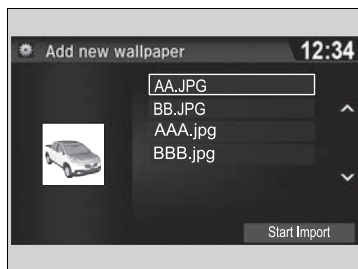
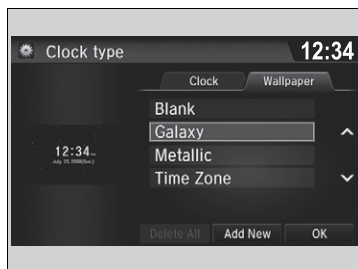

1. Connect the USB flash drive to the USB port.

▶ **USB Port(s)** P. 201

2. Select **Settings**.
3. Select **Clock/Info**.
4. Select **Clock/Wallpaper Type**, then open the **Wallpaper** tab.
5. Select **Add New**.
 - ▶ The picture name is displayed on the list.
6. Select a desired picture.
 - ▶ The preview is displayed on the left side on the screen.
7. Select **Start Import** to save the data.
 - ▶ The display will return to the wallpaper list.

Wallpaper Setup

The wallpaper you set up on **Clock/Wallpaper Type** cannot be displayed on the multi-information display.

- When importing wallpaper files, the image must be in the USB flash drive's root directory. Images in a folder cannot be imported.
- The file name must be fewer than 255 characters.
- The file format of the image that can be imported is BMP (bmp) or JPEG (jpg).
- The individual file size limit is 5 MB.
- The maximum image size is 4,096 × 4,096 pixels. If the image size is less than 800 × 480 pixels, the image is displayed in the middle of the screen with the extra area appearing in black.
- If the USB flash drive does not have any pictures, the **No files detected** message appears.

■ Select wallpaper

1. Select **Settings**.
2. Select **Clock/Info**.
3. Select **Clock/Wallpaper Type**, then open the **Wallpaper** tab.
 - ▶ The screen changes to the wallpaper list.
4. Select a desired wallpaper.
 - ▶ The preview is displayed on the left side on the screen.
 - ▶ The pop-up menu appears on the screen.
5. Select **Set**.
 - ▶ The display will return to the wallpaper list.

■ To view wallpaper once it is set

1. Select .
2. Select **Info**.
3. Select .
4. Select **Clock/Wallpaper**.

■ Delete wallpaper

1. Select **Settings**.
2. Select **Clock/Info**.
3. Select **Clock/Wallpaper Type**, then open the **Wallpaper** tab.
 - ▶ The screen changes to the wallpaper list.
4. Select a wallpaper that you want to delete.
 - ▶ The preview is displayed on the left side on the screen.
 - ▶ The pop-up menu appears on the screen.
5. Select **Delete**.
 - ▶ A confirmation message appears on the screen.
6. Select **Yes** to delete completely.
 - ▶ The display will return to the wallpaper list.

▶▶ Wallpaper Setup

From the pop-up menu, select **Preview** to see a preview at full-size screen.

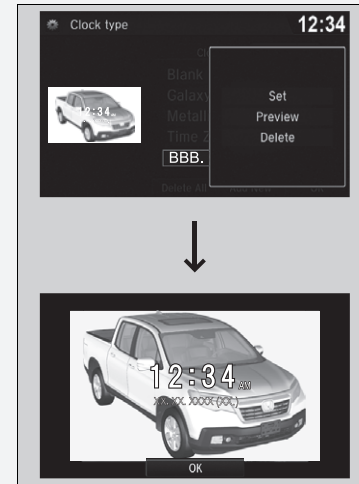

To go back to the previous screen, select **OK**, or select .

When the file size is large, it takes a while to be previewed.



To delete all wallpapers you add, select **Delete All**, then **Yes**.

Continued

■ Home Screen

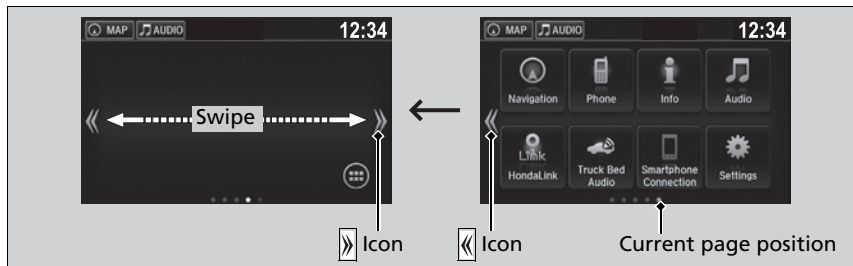
■ To change to a next screen





Selecting  or , or swiping the screen left or right changes to the next screen.

▶▶ Home Screen

The home screen has 5 pages (fixed). You cannot add any more pages.

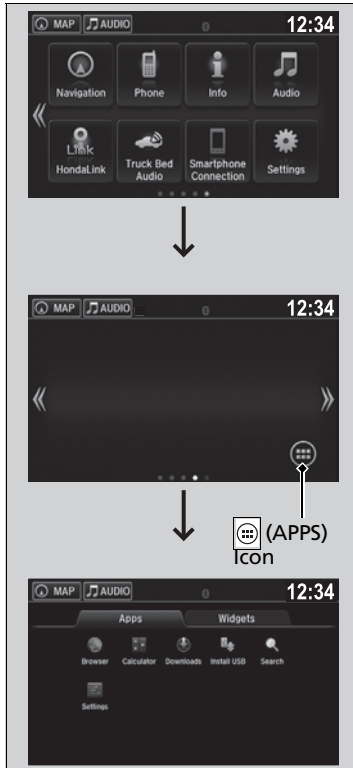
■ To use apps or widgets



1. Select .
2. Select .
- ▶ The **APPS** screen appears.
3. Select the app or widget you want to use.

Preinstall app list:

- **Browser:** Displays the web browser utilized by smartphone and Wi-Fi connection.
- **Calculator:** Displays Calculator.
- **Downloads:** Displays the data downloaded from the web browser and so on.
- **Install USB:** Check with a Honda dealer for apps that are available for installation.
- **Search:** Displays various retrieval screens.
- **Settings:** Displays the Android setting screen.

▶▶ To use apps or widgets

Select and hold a selected app or widget to add that app's or widget's shortcut on the home screen.

Pre-installed apps may not start up normally. If this occurs, you need to reset the system.

▶▶ **Defaulting All the Settings** P. 347

If you perform **Factory Data Reset**, it may reset all the settings to their factory default.

▶▶ **Defaulting All the Settings** P. 347

In case those apps still do not startup normally even after **Factory Data Reset**, contact your dealer.

There is a possibility that a browser is shut down in the situation of the use. In that situation, the screen will return to before the browser startup.

Do not install apps other than those confirmed by a Honda dealer. Installation of unauthorized apps may introduce data corruption risks to your vehicle's information and your privacy.

You can delete user installed apps by the following procedure.

1. Select .
2. Select **Settings**.
3. Select **System**.
4. Select the **Others** tab.
5. Select **Detail Information**.
6. Select an App that you want to delete.
7. Select **Delete**.



Pre-installed apps cannot be deleted.

Continued

■ To add app or widget icons on the home screen

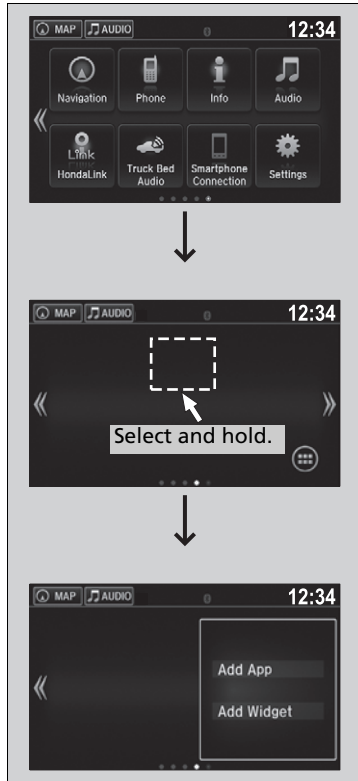
App or widget icons can be added on the home screen.



1. Select .
2. Select .
3. Select and hold empty space on the home screen.
 - ▶ The pop-up menu appears on the screen.
4. Select **Add App** or **Add Widget**.
 - ▶ The corresponding screen will be displayed.

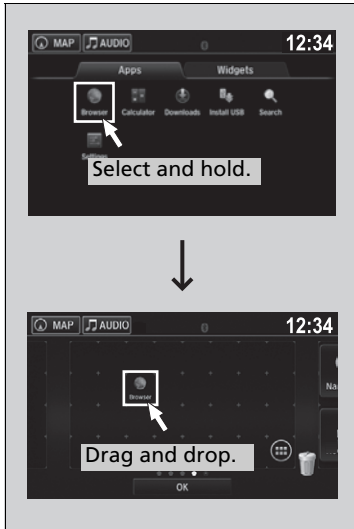

5. Select and hold an app or widget icon you want to add.
 - ▶ The screen switches to the customization screen.
6. Drag and drop the icon to where you want it to be.
7. Select **OK**.
 - ▶ The screen will return to the home screen.

■ To move icons on the home screen

You can change location on the home screen.

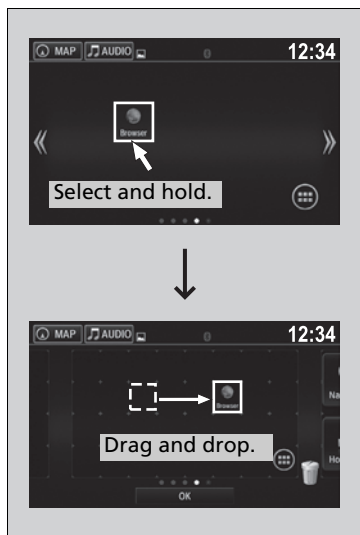

1. Select and hold an icon.
 - ▶ The screen switches to the customization screen.
2. Drag and drop the icon to where you want it to be.
3. Select **OK**.
 - ▶ The screen will return to the home screen.

▶▶ To move icons on the home screen

You can also move the **Phone, Info, Audio, Settings, Navigation***, **HondaLink, Smartphone Connection**, and **Truck Bed Audio*** icons in the same manner.

■ To remove icons on the home screen

You can delete the icons on the home screen.

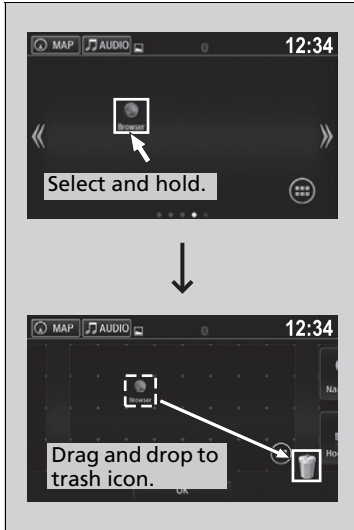

1. Select and hold an icon.
 - ▶ The screen switches to the customization screen.
2. Drag and drop the icon you want to remove to the trash icon.
 - ▶ The icon is removed from the home screen.
3. Select **OK**.
 - ▶ The screen will return to the home screen.

☒ To remove icons on the home screen

You cannot delete the **Phone, Info, Audio, Settings, Navigation***, **HondaLink, Smartphone Connection,** and **Truck Bed Audio*** icons.



Apps or widgets will not be deleted by deleting the icon on the home screen.

* Not available on all models

Continued

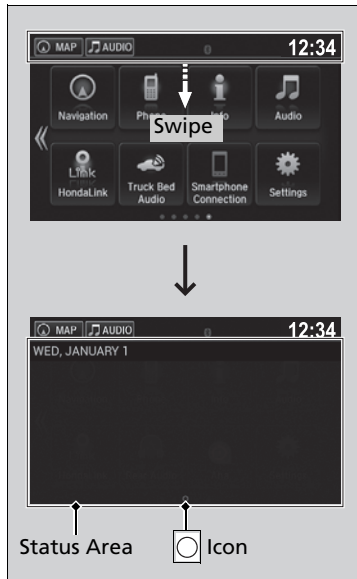
Status Area



1. Swipe the upper area of the screen.
 - ▶ The status area appears.
2. Select an item to see the details.
3. Select  or swipe up the  to close the area.

Closing Apps

You can close specific apps running in the background on the system.

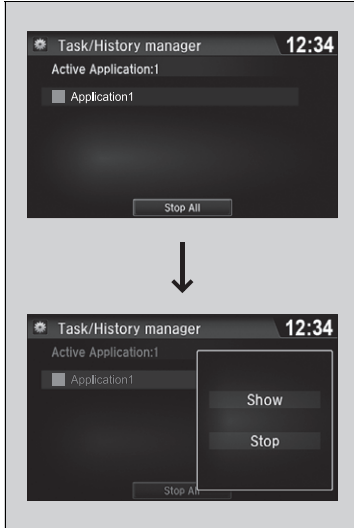

1. Select and hold .
2. Select an app you want to close.
3. Select **Stop**.
 - ▶ The display will return to the app list.

Closing Apps

If you leave the apps used open in the background, some apps may stop operating properly next time using them.

If this happens close unused apps.

To close all apps on the system, select **Stop All**, then **Yes**.

You cannot close the apps of HondaLink® and Garmin™.

■ Updating Apps

Some of the audio system's apps can be updated wirelessly when connected via Wi-Fi, or *Bluetooth*® in conjunction with the HondaLink® app installed on a compatible iOS or Android device. If an update is available, the audio system beeps and a notification is displayed at the top of the screen with the respective app's update icon.

■ To update an app:

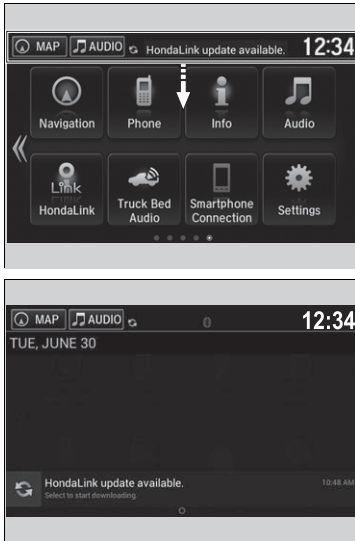

1. From the top of the screen, swipe down to see the messages.
2. Select the software update notification from the list.

▶▶ Updating Apps

The wireless updates are for the apps on the audio system only.

To update compatible apps on your iPhone or Android phone, please visit the App Store or Google Play Store, respectively.

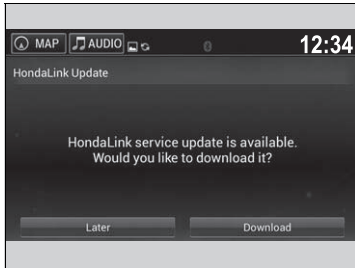

3. Select **Download**.

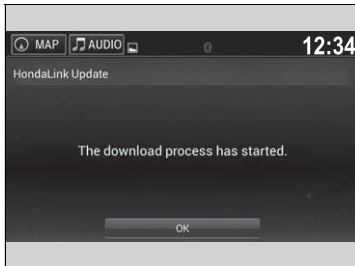

4. Select **OK**.

Adjusting the Sound

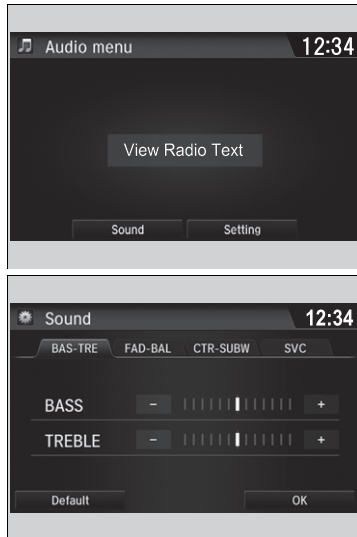

1. Select .
2. Select **Audio**.
3. Select .
4. Select **Sound**.

Select a tab from the following choices:

- **BASS-TRE**: Bass, Treble
- **FAD-BAL**: Fader, Balance
- **CTR-SUBW**: Center, Subwoofer
- **SVC**: Speed Volume Compensation

▶▶ Adjusting the Sound

The SVC has four modes: **Off**, **Low**, **Mid**, and **High**. SVC adjusts the volume level based on the vehicle speed. As you go faster, audio volume increases. As you slow down, audio volume decreases.

You can also adjust the sound the following procedure.

1. Select .
2. Select **Settings**.
3. Select **Audio**.
4. Select **Sound**.

When the Truck Bed Audio system is played select a tab from the following choices:

- **BASS-TRE**: Bass, Treble
- **SUBW**: Subwoofer
- **SVC**: Speed Volume Compensation

Display Setup

You can change the brightness or color theme of the audio/information screen.

Changing the Screen Brightness

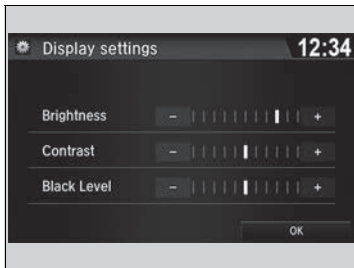

1. Select .
2. Select **Settings**.
3. Select **System**.
4. Select the **Display** tab.
5. Select **Display Settings**.
6. Select the setting you want.
7. Select **OK**.

Changing the Screen's Color Theme

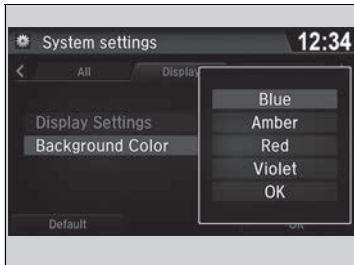

1. Select .
2. Select **Settings**.
3. Select **System**.
4. Select the **Display** tab.
5. Select **Background Color**.
6. Select the setting you want.
7. Select **OK**.

▶▶ Changing the Screen Brightness

You can change the **Contrast** and **Black Level** settings in the same manner.

■ Selecting an Audio Source

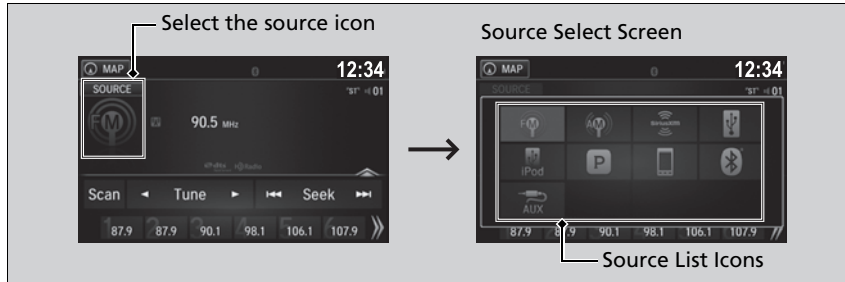



Select the current source icon, then select an icon on the source list to switch the audio source.

■ Limitations for Manual Operation

Certain manual functions are disabled or inoperable while the vehicle is in motion. You cannot select a grayed-out option until the vehicle is stopped.

Voice Control Operation

Your vehicle has a voice control system that allows hands-free operation.

The voice control system uses the  (Talk) and  (hang-up/back) buttons on the steering wheel and a microphone near the map lights on the ceiling.

Voice Recognition

To achieve optimum voice recognition when using the voice control system:

- Make sure the correct screen is displayed for the voice command that you are using.



The system recognizes only certain commands.

Available navigation commands.

 **Voice Portal Screen** P. 246

- Close the windows.
- Adjust the dashboard and side vents so air does not blow onto the microphone on the ceiling.
- Speak clearly in a clear, natural speaking voice without pausing between words.
- Reduce any background noise if possible. The system may misinterpret your command if more than one person is speaking at the same time.

Voice Control Operation

When you press the  button, a helpful prompt asks what you would like to do. Press and release the  button again to bypass this prompt and give a command.

Voice Recognition

The voice control system can only be used from the driver's seat because the microphone unit removes noises from the front passenger's side.

Continued

Voice Portal Screen

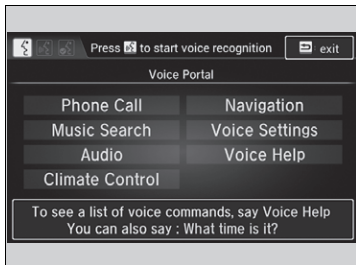

When the  (Talk) button is pressed, available voice commands appear on the screen.

For a complete list of commands, say "Voice Help" after the beep or select **Voice Help**.

You can see the list of commands in **Voice Info** on the **Info menu** screen. Select **Info**, then select .

The system only recognizes the commands on the following pages, at certain screens. Free form voice commands are not recognized.

*1: Models with navigation system

* Not available on all models

Phone Call

This can be only used when the phone is connected. When the system recognizes the *Phone call* command, the screen will change the dedicated screen for the voice recognition of the phone.

- *Dial by number*
- *Call history*
- *Redial*
- *Call <Your Contact Name>*
- *Call <Phone Number>*

Phone Call commands are not available if using Apple CarPlay.

Music Search*¹

This can be only used when the iPod or USB device is connected.

Audio*¹

When the system recognizes the *Audio* command, the screen will change the dedicated screen for the voice recognition of the audio.

- *Audio On*
- *Audio Off*
- *Radio FM*
- *Radio AM*
- *Radio SXM**
- *DISC**
- *Pandora**
- *iPod*
- *USB*
- *Other Sources*

Pandora®* cannot be used with Android Auto.

Navigation*¹

The screen changes the navigation screen.

 **Refer to the Navigation System Manual**

Voice Settings

The screen changes the **Voice Recog** tab on the **System settings** screen.

Trip Computer*¹

The screen changes the trip computer screen.

■ Voice Help

You can see a list of the available commands on the screen.

- *Useful Commands**
- *Phone Commands*
- *Audio Commands**
- *Climate Control Commands**
- *On Screen Commands*
- *Music Search Commands**
- *General Commands**
- *Voice Settings*
- *Getting Started*
- *All Commands*

■ Useful Commands

The system accepts these commands on the voice portal top screen.

- *Call <Phone Number>*
- *Call <Your Contact Name>*
- *What time is it?*
- *What is today's date?*

■ Phone Commands

The system accepts these commands on the dedicated screen for the voice recognition of the phone.

- *Call by Number*
- *Call by Name*
- *Call <Phone Number>*
- *Call <Your Contact Name>*

■ Audio Commands*¹

The system accepts these commands on the dedicated screen for the voice recognition of the audio.

■ Radio FM Commands*

- *Radio tune to <87.7-107.9> FM*
- *Radio tune to <87.7 -107.9> HD <1-8> FM*
- *Radio FM preset <1-12>*

■ Radio AM Commands

- *Radio tune to <530-1710> AM*
- *Radio AM preset <1-6>*

■ Radio SXM Commands*

- *SXM channel <1-999>*
- *SXM channel <station name>*
- *Radio SXM preset <1-12>*

■ DISC Commands*

- *DISC play*
- *DISC play track <1-30>*

■ Pandora Commands*

- *Pandora play*

■ iPod Commands

- *iPod play*
- *iPod play track <1-30>*
- *Music Search*
- *What album is this?*
- *What am I listening to?*

■ USB Commands

- *USB play*
- *USB play track <1-30>*
- *Music Search*
- *What album is this?*
- *What am I listening to?*

■ Bluetooth® audio Commands

- *Bluetooth® audio play*

NOTE:

Bluetooth® Audio commands may not work on some phones or *Bluetooth®* Audio devices.

* Not available on all models

■ AUX-Audio commands

- *AUX audio play*

■ On Screen Commands

When **On Screen Commands** is selected, the explanation screen is displayed.

■ Music Search Commands*1

The system accepts these commands on the **Music Search** screen.

■ Using Song By Voice

Song By Voice™ is a feature that allows you to select music from your iPod or USB device using Voice Commands. To activate this mode, you must push the talk switch and say: "Music search".

■ Song By Voice Commands

- *What am I listening to?*
- *Who am I listening to?*
- *Who is this?*
- *What's playing?*
- *Who's playing?*
- *What album is this?*

*1: Models with navigation system

■ Play Commands

- *Play artist <Name>*
- *Play track/song <Name>*
- *Play album <Name>*
- *Play genre/category <Name>*
- *Play playlist <Name>*
- *Play composer <Name>*

■ List Commands

- *List artist <Name>*
- *List album <Name>*
- *List genre/category <Name>*
- *List playlist <Name>*
- *List composer <Name>*

■ General Commands

- *What time is it?*
- *What is today's date?*

■ Climate Control Commands*1

- *Climate Control on*
- *Climate Control off*
- *Fan Speed <1-7>*
- *Temperature max heat*
- *Temperature max cool*
- *Temperature <57-87> degrees*
- *Defrost on*
- *Defrost off*
- *Air conditioner on*
- *Air conditioner off*
- *More*
- *Climate control automatic*
- *Vent*
- *Dash and floor*
- *Fan speed up*
- *Fan speed down*
- *Floor vents*
- *Floor and defrost*
- *Temperature up*
- *Temperature down*

Playing AM/FM Radio

Multi-Information Display

Audio/Information Screen

Audio/Information Screen

Open/Close Icon^{*1}
Displays/hides the detailed information.

Seek Icons
Select or to search up and down the selected band for a station with a strong signal.

Preset Icons
Tune the radio frequency for preset memory. Select and hold the preset icon to store that station. Select to display preset 7 onwards.

Power/Audio (Power/Audio) Icon
Select to turn the audio system on and off.

VOL (Volume) Icons
Select to adjust the volume.

(Menu) Icon
Select to display the menu items.

(Back) Icon
Select to go back to the previous display.

Scan Icon
Select to scan each station with a strong signal.

Tune Icons
Select or to tune the radio frequency.

*1:Some or all of the lists may not be displayed.

■ Preset Memory

To store a station:

1. Tune to the selected station.
2. Select and hold the preset number for the station you want to store.

You can also store a preset station by the following procedure.

1. Tune to the selected station.
2. Select the open/close icon to display a list.
3. Select the **Preset** tab.
4. Select and hold the preset number for the station you want to store.

■ Station List

Lists the strongest stations on the selected band.

1. Select the open/close icon to display a list.
2. Select the **Station List** tab.
3. Select the station.

■ Manual update

Updates your available station list at any time.

1. Select the open/close icon to display a list.
2. Select the **Station List** tab.
3. Select **Refresh**.

▶▶ Preset Memory

The **ST** indicator appears on the display indicating stereo FM broadcasts.

Stereo reproduction in AM is not available.

Switching the Audio Mode

Press the **SOURCE** button on the steering wheel or select **SOURCE** on the screen.

▶▶ **Audio Remote Controls** P. 204

You can store 6 AM stations and 12 FM stations into preset memory.

▶▶ Models with HD Radio™

HD Radio Technology manufactured under license from iBiquity Digital Corporation. U.S. and Foreign Patents. HD Radio™ and the HD, HD Radio, and "Arc" logos are proprietary trademarks of iBiquity Digital Corp.



■ Scan

Samples each of the strongest stations on the selected band for 10 seconds. To turn off scan, select **Cancel** or .

■ Radio Data System (RDS)

Provides text data information related to your selected RDS-capable FM station.

■ To find an RDS station from Station List

1. Select the open/close icon to display a list while listening to an FM station.
2. Select the **Station List** tab.
3. Select the station.

■ Manual update

Updates your available station list at any time.

1. Select the open/close icon to display a list while listening to an FM station.
2. Select the **Station List** tab.
3. Select **Refresh**.

■ Radio text

Displays the radio text information of the selected RDS station.

1. Select .
2. Select **View Radio Text**.

■ Scan

Samples each of the strongest stations on the selected band for 10 seconds.

To turn off scan, select **Cancel** or .

⌘ Radio Data System (RDS)

When you select an RDS-capable FM station, the RDS automatically turns on, and the frequency display changes to the station name. However, when the signals of that station become weak, the display changes from the station name to the frequency.

Models with HD Radio™

■ HD Subchannel

Displays the subchannel list when an HD Radio™ station is selected while listening to an FM station.

1. Select .
2. Select **HD Radio Subchannel**.
3. Select the channel number.

Playing SiriusXM® Radio*

Multi-Information Display

Channel Icons
 Select **◀◀** or **▶▶** to the previous or next channel.
 Select and hold to rapidly skip 10 channels at a time.

Audio/Information Screen

Station Art

Open/Close Icon^{*1}
 Displays/hides the detailed information.

Skip Icons
 Select **◀◀** or **▶▶** to change section in the channel. Select and hold to move rapidly within the section.

Preset Icons
 Tune the radio frequency for preset memory. Select and hold the preset icon to store that station. Select **>>** to display preset 7 onwards.

Album Art

Multi-Information Display (Top Screen): Shows 002345 miles, D, and 63°F.

Audio/Information Screen (Bottom Screen): Shows MAP, SOURC, CH 000 AAA, Live, 12:34, and a list of channels (Channel 8, Channel 3, Channel 26, 49, 115, 176).

Control Panel Icons:

- Power/Audio Icon:** Press to turn the audio system on and off.
- VOL (Volume) Icons:** Select to adjust the volume.
- (Menu) Icon:** Select to display the menu items.
- (Back) Icon:** Select to go back to the previous display.
- Scan Icon:** Select to scan each channel.
- Category Icons:** Select **◀** or **▶** to display and select a SiriusXM® Radio category.

*1:Some or all of the lists may not be displayed.

* Not available on all models

■ To Change the Tune Mode

1. Select .
2. Select **Tune Mode**.
3. Select **Channel Mode** or **Category Mode**.

▶▶ Playing SiriusXM® Radio*

In the channel mode, all available channels are selectable. In the category mode, you can select a channel within a category (Jazz, Rock, Classical, etc.).

There may be instances when SiriusXM® Radio does not broadcast all the data fields (artist name, title). This does not indicate a problem with your audio system.

SiriusXM® Radio stations load in ascending order, which can take about a minute. Once they have loaded you will be able to scroll up or down to make your selections.

Switching the Audio Mode

Press the **SOURCE** button on the steering wheel or select **SOURCE** on the screen.

▶ **Audio Remote Controls** P. 204

Tune Start:

When you change to a preset channel, a song being played on that channel restarts from the beginning with this function. This can be turned on or off from the **Audio settings** screen.

▶ **Customized Features** P. 323

■ Preset Memory

To store a channel:

1. Tune to the selected channel.
2. Select and hold the preset number for the station you want to store.
3. Select **Replace**.

You can also store a channel by the following procedure.

1. Tune to the selected channel.
2. Select the open/close icon to display a list.
3. Select the **Preset** tab.
4. Select and hold the preset number for the station you want to store.

■ Multi-channel preset (for music channels only)

You can store up to four of your preferred music channels per preset.

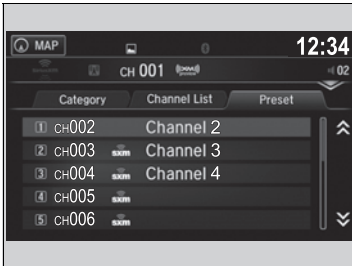

1. Tune a station.
2. Select the open/close icon to display a list.
3. Select the **Preset** tab.
4. Select and hold the preset number you want to add a music channel.
 - ▶ A message appears if there are no available presets.
5. Select **Combine**.

▶▶ Playing SiriusXM® Radio*

You can store 12 SiriusXM® channels into the preset memory.

■ Listening to Featured Channels

Suggested channel listing received from SiriusXM® can be displayed and selected.

1. Select the open/close icon to display a channel list.
2. Select the **Channel List** tab.
3. Select the featured channel list title you want to listen to.
 - ▶ The selected channel list of the title is displayed.
4. Select the channel.

▶▶ Listening to Featured Channels

Up to three featured channels by SiriusXM® can be displayed.

Featured channel lists are at the top of the channel list.

Replay Function

The system can record up to the last 60 minutes broadcast of your currently tuned channel as well as the last 30 minutes broadcast of preset channels, starting from the moment you turn the vehicle on. If you tuned to preset channel, the system records up to 60 minutes of a broadcast instead of up to 30 minutes. You can rewind and replay the last 30 or 60 minutes of a broadcast.

1. Select .
2. Select **Playback Position**.
3. Move the gauge to the position you want to replay.

To play or pause on playback mode:

1. Select .
2. Select **Play/Pause**.

Returning to real-time broadcast

1. Select .
2. Select **Play Live Broadcast**.

Replay Function

The system starts storing broadcast in memory when the power mode is turned ON. You can go back to the program from that point.

You can no longer replay any program once the power mode is turned off as it erases memory. You can check how long the program has been stored in memory from the audio/information screen.

After 30 or 60 minutes of recording the system will automatically start deleting the oldest data.

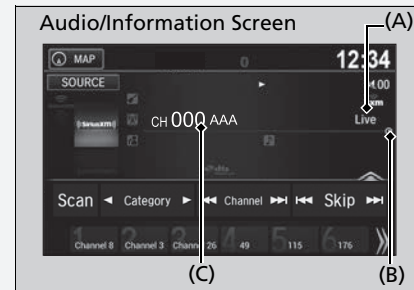

(A): Shows how much time the replayed segment is behind the real-time broadcast

(B): Replayed segment

(C): Length stored in memory

■ Live Sports Alert

While listening to other channel, you can receive sports alerts such as scores from your favorite teams.

■ To set up a favorite team

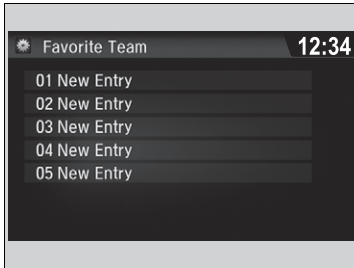

1. Select .
2. Select **Settings**.
3. Select **Audio**.
4. Select the **SXM** tab.
5. Select **SportFlash Setup(Favorite Team)**.
6. Select a team.

■ To set up an alert message

1. Select .
2. Select **Settings**.
3. Select **Audio**.
4. Select the **SXM** tab.
5. Select **SportFlash Setup(Interrupt)**.
6. Select **On(one time)** or **On(continue)**.

▶▶ Live Sports Alert

The sports alert function at SiriusXM® mode only.

▶▶ To set up a favorite team

Sports alerts cut in only when SiriusXM® mode is on. Selecting **On(one time)** from the customize settings disables the alert feature next time you turn the power mode to ON.

 **Customized Features** P. 323

You can also set up a favorite team by the following procedure.

1. Select **Audio**.
2. Select .
3. Select **Setting**.
4. Select the **SXM** tab.

■ To set up a alert beep

1. Select .
2. Select **Settings**.
3. Select **Audio**.
4. Select the **SXM** tab.
5. Select **SportFlash Setup(Interrupt Beep)**.
6. Select **On**.

■ Traffic and Weather Information

You can receive traffic and weather information.

1. Select .
2. Select **Settings**.
3. Select **Audio**.
4. Select the **SXM** tab.
5. Select **Traffic & Weather Setup**.
6. Select the region.
 - ▶ When you do not want to receive the information, select **Unset**.

☒ To set up a alert beep

You can also set up a alert beep by the following procedure.

1. Select **Audio**.
2. Select .
3. Select **Setting**.
4. Select the **SXM** tab.

☒ Traffic and Weather Information

The traffic and weather information function at SiriusXM® mode only.

You can also set up the traffic and weather information by the following procedure.

1. Select **Audio**.
2. Select .
3. Select **Setting**.
4. Select the **SXM** tab.

Continued

■ Scan

Sample each channel on the selected mode for 10 seconds.

1. Select **Scan**.
2. Select **Scan Channels**.
 - ▶ You can select the desired channel by songs using **Scan Songs In Presets**.

To turn off scan, select **Cancel**.

☒ Scan

The “Scan Songs in Presets” function is based on TuneScan™ technology of SiriusXM®.

The “Featured Channels” function is based on Featured Favorites™ technology of SiriusXM®.

TuneScan™ and Featured Favorites™ are registered trademarks of SiriusXM® Radio, Inc.

Canadian models

Playing a CD

Your audio system supports audio CDs, CD-Rs, and CD-RWs in either MP3, WMA, or AAC*1 format. With the CD loaded, select the CD mode.

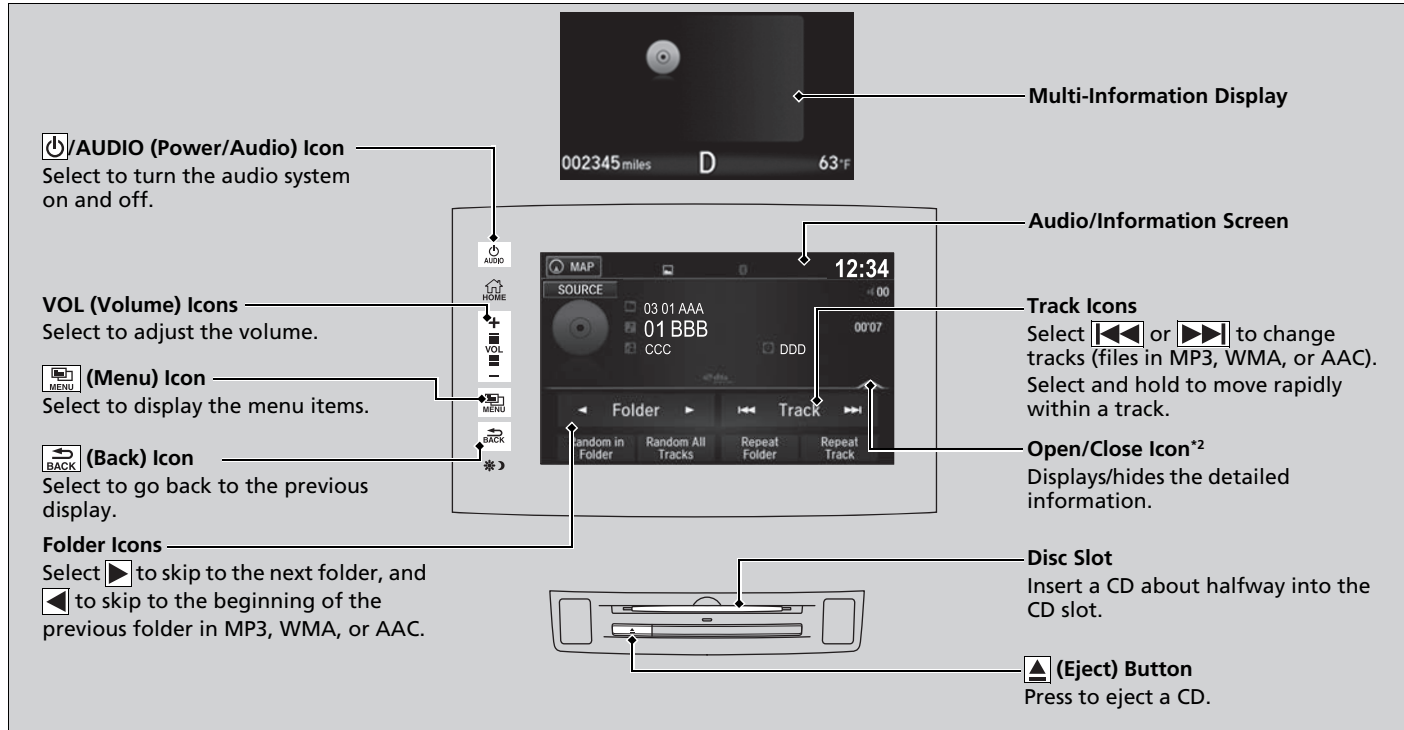

*1: Only AAC format files recorded with iTunes are playable on this unit.

*2: Some or all of the lists may not be displayed.

How to Select a File from the Music Search List (MP3/WMA/AAC)

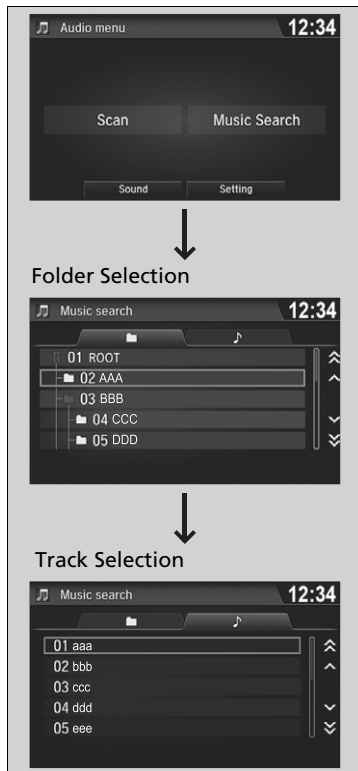

1. Select  and select **Music Search**.

2. Select a folder.

3. Select a track.

▶▶ Playing a CD

NOTICE

Do not use CDs with adhesive labels. The label can cause the CD to jam in the unit.

WMA files protected by digital rights management (DRM) cannot be played.

The audio system displays **Unplayable File**, then skips to the next file.

Text data appears on the display under the following circumstances:

- When you select a new folder, file, or track.
- When you change the audio mode to CD.
- When you insert a CD.

If you eject the CD but do not remove it from the slot, the system reloads the CD automatically after several seconds.

How to Select a Play Mode

You can select scan, repeat, and random modes when playing a track or file.

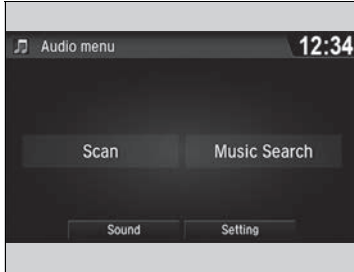

Scan

1. Select .
2. Select **Scan**.
3. Select a play mode.

Random/Repeat

Select a play mode.



To turn off a play mode

Select the mode you want to turn off.

How to Select a Play Mode

Play Mode Menu Items

Scan

Scan Folders (MP3/WMA/AAC): Provides 10-second sampling of the first file in each of the main folders.

Scan Tracks: Provides 10-second sampling of all tracks on the CD (all files in the current folder in MP3, WMA, or AAC).

Random/Repeat

Repeat Folder (MP3/WMA/AAC): Repeats all files in the current folder.

Repeat/Repeat Track: Repeats the current track/file.

Random in Folder (MP3/WMA/AAC): Plays all files in the current folder in random order.

Random/Random All Tracks: Plays all tracks/files in random order.

Playing an iPod

Connect the iPod using your dock connector to the USB port, then select the iPod mode.

➤ **USB Port(s)** P. 201

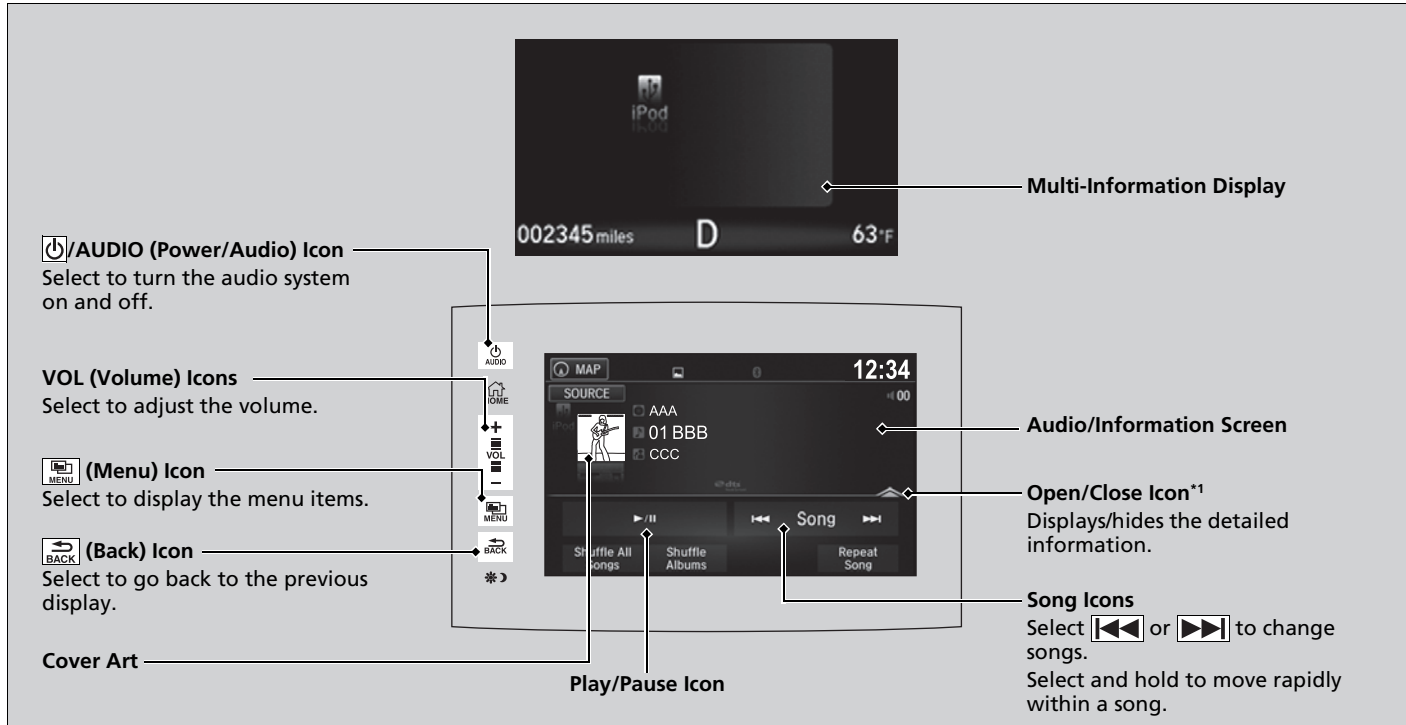

*1: Some or all of the lists may not be displayed.

How to Select a Song from the Music Search List

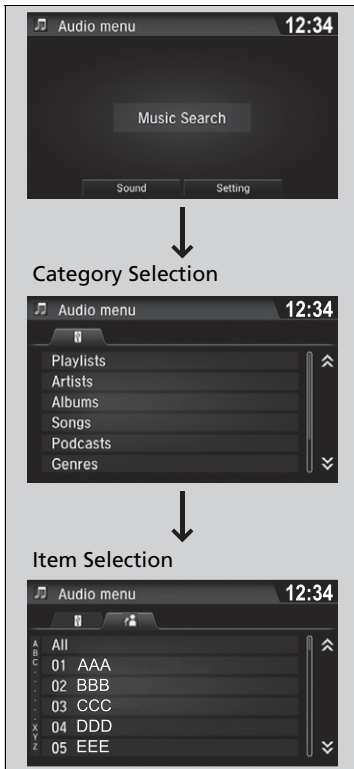

1. Select  and select **Music Search**.

2. Select the items on that menu.

▶▶ Playing an iPod

Available operating functions vary on models or versions. Some functions may not be available on the vehicle's audio system.

If there is a problem, you may see an error message on the audio/information screen.

 **iPod/USB Flash Drive** P. 295

If you operate the music app on your iPhone/iPod while the phone is connected to the audio system, you may no longer be able to operate the same app on the audio/information screen. Reconnect the device if necessary.

If an iPhone is connected via Apple CarPlay, the iPod/USB source will be unavailable and audio files on the phone will be playable only within Apple CarPlay.

■ How to Select a Play Mode

You can select shuffle and repeat modes when playing a file.

Select a play mode.

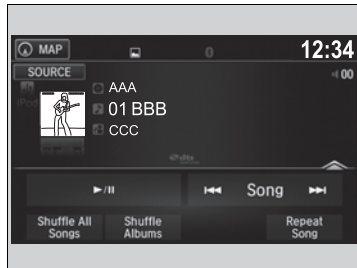

■ To turn off a play mode

Select the mode you want to turn off.

▶▶ How to Select a Play Mode

Play Mode Menu Items

Shuffle All Songs: Plays all available files in a selected list (playlists, artists, albums, songs, podcasts, genres, composers, or audiobooks) in random order.

Shuffle Albums: Plays all available albums in a selected list (playlists, artists, albums, songs, podcasts, genres, composers, or audiobooks) in random order.

Repeat Song: Repeats the current track.

Models with navigation system

Song By Voice™ (SBV)

Use SBV to search for and play music from your USB flash drive or iPod using voice commands.

■ To enable SBV

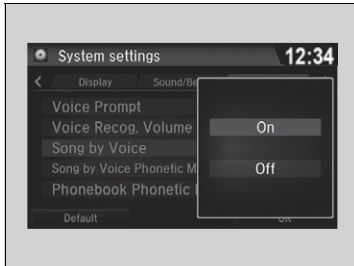

1. Select .
2. Select **Settings**.
3. Select **System**.
4. Select the **Voice Recog** tab.
5. Select **Song by Voice**.
6. Select **On** or **Off**.

⌘ Song By Voice™ (SBV)



Setting options:

- **On** (factory default): Song By Voice™ commands are available.
- **Off**: Disable the feature.

Continued

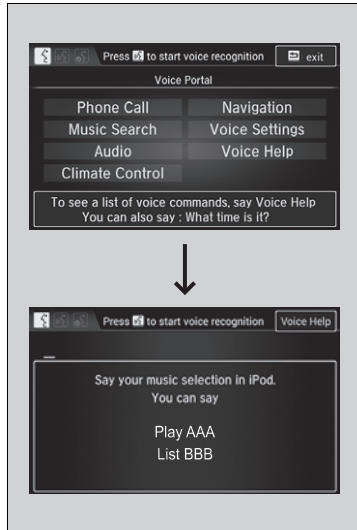
■ Searching for music using SBV



1. Set the **Song by Voice** setting to **On**.
2. Press the  (Talk) button and say "Music Search" to activate the SBV feature for the USB flash drive and iPod.
3. Press the  button and say a command.
 - ▶ Example 1: Say "(List) 'Artist A'" to view a list of songs by that artist. Select the desired song to start playing.
 - ▶ Example 2: Say "Play 'Artist A'" to start playing songs by that artist.
4. To cancel SBV, press the  (hang-up/back) button on the steering wheel. The selected song continues playing.

Once you have canceled this mode, you need to press the  button and say "Music Search" again to re-activate this mode.

▶▶ Searching for music using SBV

Song By Voice™ Commands List

▶ **Song By Voice Commands** P. 248

NOTE:

Song By Voice™ commands are available for tracks stored on the USB flash drive or iPod.

You can add phonetic modifications of difficult words so that it is easier for SBV to recognize artists, songs, albums, and composers in voice commands.

▶ **Phonetic Modification** P. 269

Phonetic Modification

Add phonetic modifications of difficult or foreign words so that it is easier for SBV to recognize artists, songs, albums, and composers in voice commands when searching for music on the USB flash drive or iPod.

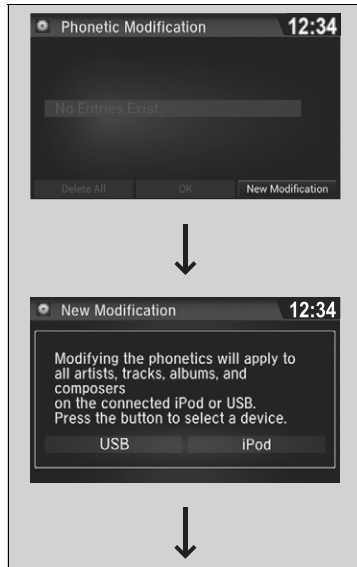



1. Select .
2. Select **Settings**.
3. Select **System**.
4. Select the **Voice Recog** tab.
5. Select **Song by Voice Phonetic Modification**.
6. Select **New Modification**.
7. Select **USB** or **iPod**.

Phonetic Modification

Song by Voice Phonetic Modification is grayed out when **Song By Voice** is set to **Off**.

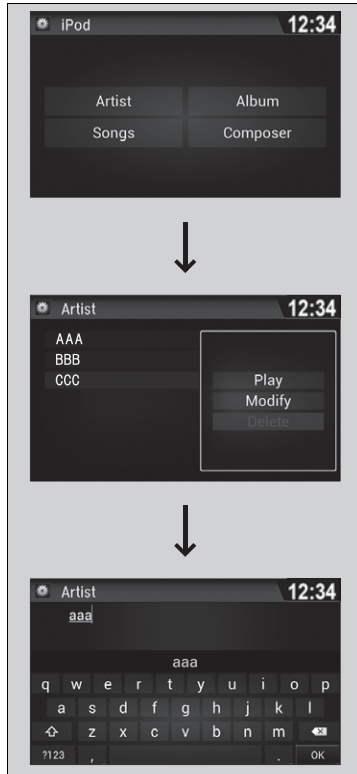
You can store up to 2,000 phonetic modification items.



8. Select the item to modify (e.g., **Artist**).
 - ▶ The list of the selected item appears on the screen.
9. Select an entry to modify.
 - ▶ The pop-up menu appears on the screen.
 - ▶ The listen to the current phonetic modification, select **Play**.
 - ▶ To delete the current phonetic modification, select **Delete**.
10. Select **Modify**.
11. Select the phonetic spelling you want to use (e.g., "Artist A") when prompted.
12. Select **OK**.
 - ▶ The artist "No Name" is phonetically modified to "Artist A." When in the SBV mode, you can press the  (Talk) button and use the voice command "Play 'Artist A'" to play songs by the artist "No Name."

U.S. models

Playing Pandora®

Your audio system allows you to listen to music from the Pandora® app on a compatible smartphone.

This function is available when the phone is paired and connected to the vehicle's *Bluetooth*® HandsFreeLink® (HFL) system, or with an iPhone, you can connect using your USB cable to the USB port.

➤ **Phone Setup** P. 384

➤ **USB Port(s)** P. 201

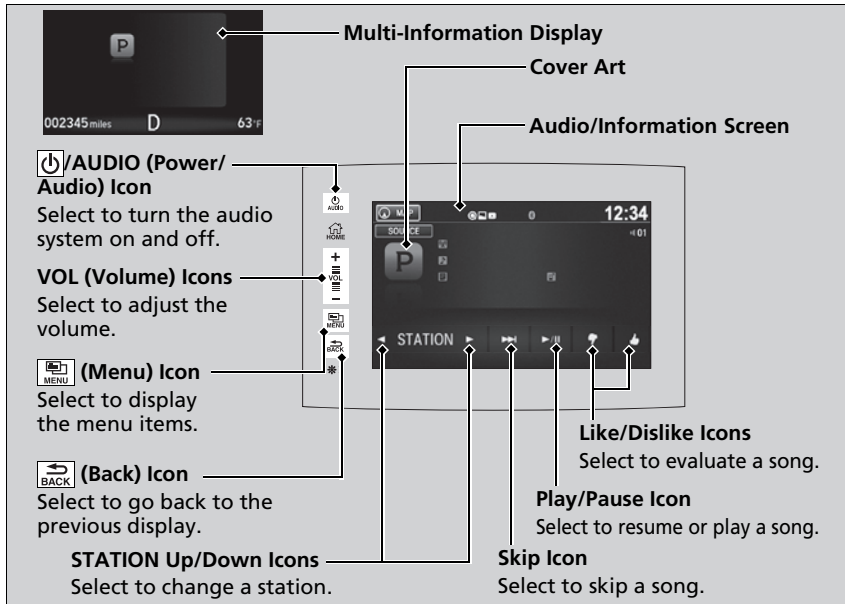

▶▶ Playing Pandora®

Pandora®, the Pandora logo, and the Pandora trade dress are trademarks or registered trademarks of Pandora Media, Inc., used with permission. Pandora is only available in certain countries. Visit the Pandora website for more information.

To find out if your phone is compatible with this feature, visit automobiles.honda.com/handsfreelink/, or call 1-888-528-7876.

To use this service in your vehicle, the Pandora® app must first be installed on your phone. Visit www.pandora.com for more information.

Pandora® is free, personalized radio that plays music and comedy you'll love. Just start with the name of one of your favorite artists, songs, comedians or composers and Pandora® will create a custom station that plays similar tracks. Pandora® also features hundreds of genre stations ranging from Dubstep to Smooth Jazz to Power Workout.

If you cannot operate Pandora® through the audio system, it may be streaming through *Bluetooth*® Audio. Make sure Pandora® mode on your audio system is selected.

If your phone is connected to Android Auto, Pandora will be available only through the Android Auto interface. Visit the Android Auto website to check compatibility.

Continued

■ Pandora® Menu

You can operate some of the Pandora® menu items from your vehicle's audio system. The available items are:

- **Bookmark**
- **Station List**
- **New Station**
- **Sound**
- **Setting**

■ Operating a menu item

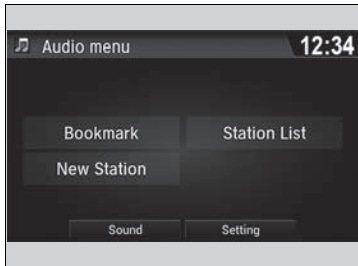

1. Select .
2. Select an item.

▶▶ Pandora® Menu

Available operating functions vary on software versions. Some functions may not be available on the vehicle's audio system.

If there is a problem, you may see an error message on the audio/information screen.

▶ **Pandora®*** P. 296

Pandora® may limit the total number of skips allowed on the service. If you dislike a track after the skip limit has been reached, your feedback will be saved but the current track will continue to play.

To change stations, activate the Pandora® menu, select **Station List**, and then select a new station. It also changes stations on the main Pandora® screen.

Playing a USB Flash Drive

Your audio system reads and plays audio files on a USB flash drive in either MP3, WMA, or AAC*1 format.

Connect your USB flash drive to the USB port, then select the USB mode.

📌 **USB Port(s)** P. 201

The diagram illustrates the audio system's interface. At the top is the **Multi-Information Display**, which shows a USB icon, '002345 miles', 'D', and '63°F'. Below it is the **Audio/Information Screen**, which displays 'MAP', 'SOURCE', '03 01 AAA', '01 BBB', '00:00', '00:07', and playback controls for 'Folder' and 'Track'. A vertical control strip on the left contains icons for AUDIO, HOME, VOL, MENU, and BACK. Labels with arrows point to these icons and the screens, explaining their functions.

🔌/AUDIO (Power/Audio) Icon
Select to turn the audio system on and off.

VOL (Volume) Icons
Select to adjust the volume.

☰ (Menu) Icon
Select to display the menu items.

⏪ (Back) Icon
Select to go back to the previous display.

Folder Icons
Select **▶** to skip to the next folder, and **◀** to skip to the beginning of the previous folder.

Multi-Information Display

Audio/Information Screen

Open/Close Icon*2
Displays/hides the detailed information.

Track Icons
Select **⏮** or **⏭** to change files. Select and hold to move rapidly within a track.

*1: Only AAC format files recorded with iTunes are playable on this unit.

*2: Some or all of the lists may not be displayed.

How to Select a File from the Music Search List

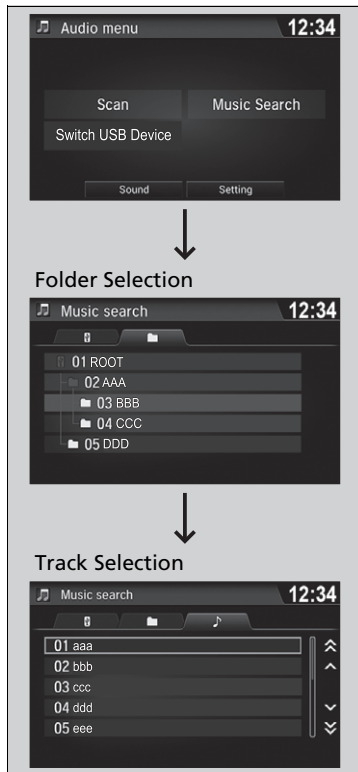

1. Select  and select **Music Search**.

2. Select a folder.

3. Select a track.

▶▶ Playing a USB Flash Drive

Use the recommended USB flash drives.

▶ **General Information on the Audio System**
P. 298

WMA files protected by digital rights management (DRM) cannot be played.

The audio system displays **Unplayable File**, then skips to the next file.

If there is a problem, you may see an error message on the audio/information screen.

▶ **iPod/USB Flash Drive** P. 295

Select **Switch USB Device** in the **Audio menu** screen to switch to another USB device.

How to Select a Play Mode

You can select scan, repeat, and random modes when playing a file.

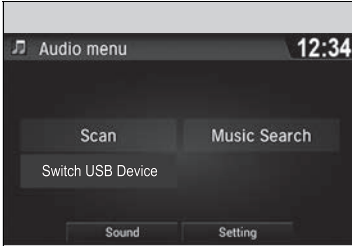

■ Scan

1. Select .
2. Select **Scan**.
3. Select a play mode.

■ Random/Repeat

Select a play mode.



■ To turn off a play mode

Select the mode you want to turn off.

How to Select a Play Mode

Play Mode Menu Items

Scan

Scan Folders: Provides 10-second sampling of the first file in each of the main folders.

Scan Tracks: Provides 10-second sampling of all files in the current folder.

Random/Repeat

Random in Folder: Plays all files in the current folder in random order.

Random All Tracks: Plays all files in random order.

Repeat Folder: Repeats all files in the current folder.

Repeat Track: Repeats the current file.

Playing *Bluetooth*® Audio

Your audio system allows you to listen to music from your *Bluetooth*-compatible phone.

This function is available when the phone is paired and connected to the vehicle's *Bluetooth*® HandsFreeLink® (HFL) system.

📄 **Phone Setup** P. 384

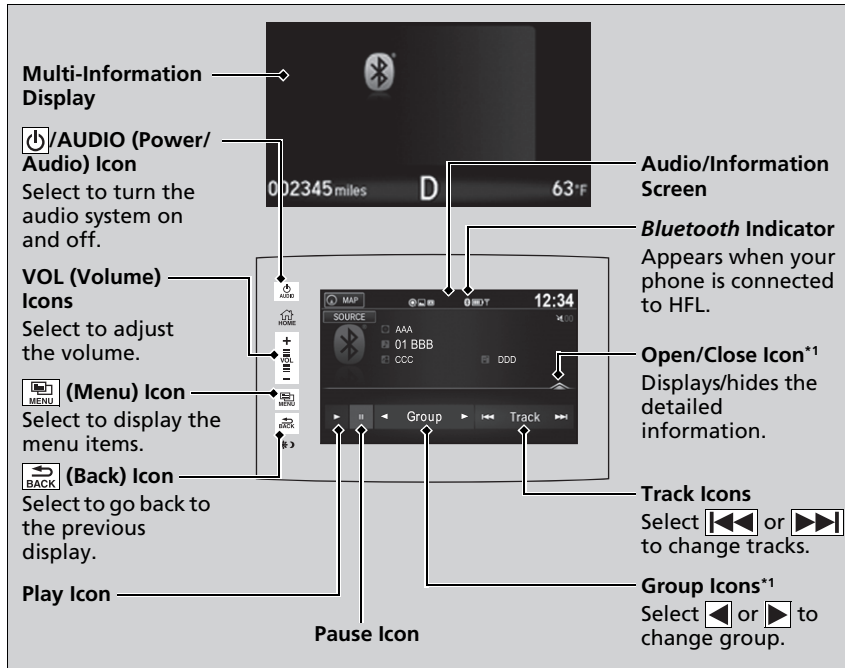

*1: Depending on the *Bluetooth*® device you connect, some or all of the lists may not be displayed.

▶▶ Playing *Bluetooth*® Audio

Not all *Bluetooth*-enabled phones with streaming audio capabilities are compatible. To check if your phone is compatible, visit automobiles.honda.com/handsfreelink/.

It may be illegal to perform some data device functions while driving.

Only one phone can be used with HFL at a time. When there are more than two paired phones in the vehicle, the first paired phone the system finds is automatically connected.

The connected phone for *Bluetooth*® Audio can be different.

If more than one phone is paired to the HFL system, there may be a delay before the system begins to play.

In some cases, the name of the artist, album, or track may not appear correctly.

Some functions may not be available on some devices.

If a phone is currently connected via Apple CarPlay or Android Auto, *Bluetooth*® Audio from that phone will be unavailable. However, you can have a second previously paired phone stream *Bluetooth*® Audio by selecting Connect from *Bluetooth* Device List.

📄 **Phone Setup** P. 384

■ To Play *Bluetooth*® Audio Files

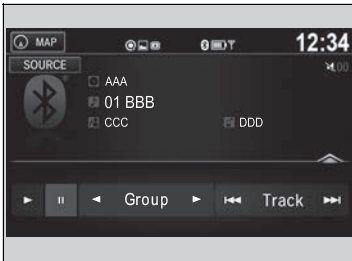

1. Make sure that your phone is paired and connected to the system.

▶ **Phone Setup** P. 384

2. Select the *Bluetooth*® Audio mode.

If the phone is not recognized, another HFL-compatible phone, which is not compatible for *Bluetooth*® Audio, may already be connected.

■ To pause or resume a file

Select the play icon or pause icon.

■ Searching for Music

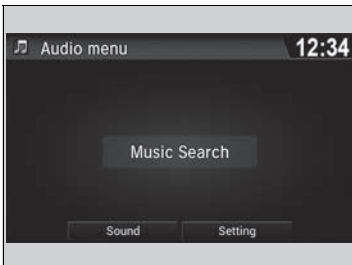

1. Select .

2. Select **Music Search**.

3. Select a search category (e.g., Albums).

4. Select an item.

▶ The selection begins playing.

▶▶ To Play *Bluetooth*® Audio Files

To play the audio files, you may need to operate your phone. If so, follow the phone maker's operating instructions.

Switching to another mode pauses the music playing from your phone.

You can change the connected phone in the *Bluetooth*® settings on the **Audio menu** screen by the following procedure.

1. Select .

2. Select **Setting**.

▶▶ Searching for Music

Depending on the *Bluetooth*® device you connect, some or all of the lists may not be displayed.

HondaLink®

HondaLink® connects you to the latest information from Honda. You can connect your phone wirelessly through Wi-Fi or *Bluetooth*®.

➔ **Wi-Fi Connection** P. 283

➔ **Phone Setup** P. 384

HondaLink® Menu

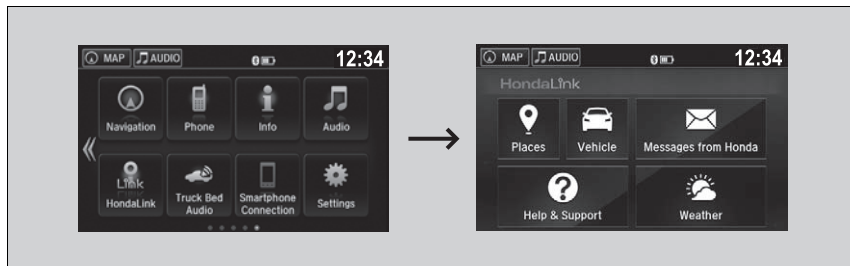

■ Places*

Displays restaurants, gas stations, Honda dealer, and so on. You can also navigate to the found locations via the navigation.

■ Vehicle

Displays instruction messages when the vehicle needs service.

■ Help & Support

Displays tips for vehicle usage, and get support via road side or customer service center.

▶▶ HondaLink®

The HondaLink® connect app is compatible with most iPhone and Android phones.

Some cell phone carriers charge for tethering and smartphone data use. Check your phone's data subscription package.

When Apple CarPlay or Android Auto is connected to the audio system, HondaLink® can be accessed even without a Wi-Fi connection.

■ Messages from Honda

Displays helpful and important information from Honda.

■ Weather

Displays a weekly five-day weather forecast for any location you want. You can change the ZIP Code at any time.

To Connect to HondaLink® Service

Use the following procedure to connect to HondaLink® service.

■ To enable the HondaLink® service

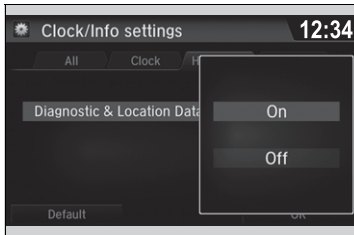

1. Select .
2. Select **Settings**.
3. Select **Clock/Info**.
4. Select the **HondaLink** tab.
5. Select **Diagnostic & Location Data**.
6. Select **On**.

You need to allow the consent of the location service to enable the HondaLink® service.

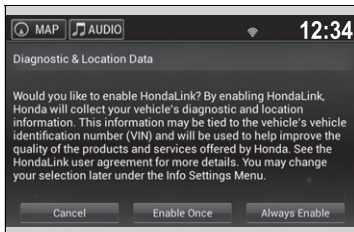

- Cancel:** Does not allow this consent.
- Enable Once:** Allows only one time. (Shows again next time.)
- Always Enable:** Allows anytime. (Never show again.)

Continued

■ To link with HondaLink®

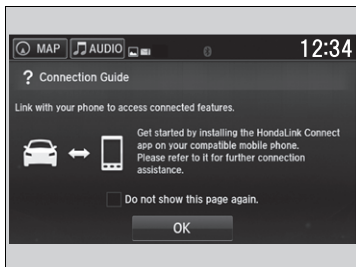

You can see the **Connection Guide** screen after launching HondaLink®. If you do not need this guide, select check-box and select **OK**.

Vehicle Information and Message from Honda Tips

You can check the messages that are received quickly in the shortcut operation.



1. A message appears and notifies you of a new message on the header area.

▶ When the message is received, a notification ring can be heard.

2. A message icon is continuously displayed in the header area until the new message is read.



3. From the top of the screen, swipe down to see the messages.

4. Select a new message to open.

Wi-Fi Connection

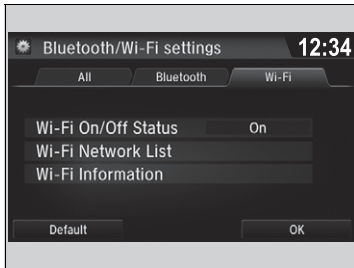

You can connect the Display Audio to the Internet using Wi-Fi and browse websites or use online services on the audio/information screen. If your phone has cell hotspot capabilities, the system can be tethered to the phone. Use the following steps to setup.

Wi-Fi mode (setting for the first time)



1. Select .
2. Select **Settings**.
3. Select **Bluetooth/Wi-Fi**.
4. Select the **Wi-Fi** tab.
5. Select **Wi-Fi On/Off Status**, then **On**.
6. Select **Wi-Fi Network List**.

- ▶ Make sure your phone's Wi-Fi setting is in access point (tethering) mode.
- ▶ Select the phone you want to connect to the system.
- ▶ If you do not find the phone you want to connect in the list, select **Scan**.

7. Select **Connect**.
 - ▶ Enter a password for your phone, and select **OK**.
 - ▶ When the connection is successful, the  icon is displayed on the list.
8. Select  to go back to the home screen.

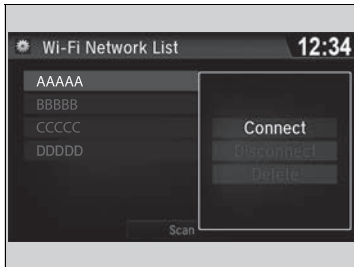

Wi-Fi mode (setting for the first time)

You cannot go through the setting procedure while a vehicle is moving. Park in a safe place to setup the Wi-Fi connection.

Some cell phone carriers charge for tethering and smartphone data use. Check your phone's data subscription package.

Check your phone manual to find out if the phone has Wi-Fi connectivity.

You can confirm whether Wi-Fi connection is on or off with the  icon on **Wi-Fi Network List**. Transmission speed and others will not be displayed on this screen.

■ Wi-Fi mode (after the initial setting has been made)

Make sure your phone's Wi-Fi setting is in access point (tethering) mode.

▶▶ Wi-Fi mode (after the initial setting has been made)

iPhone users

You may need to go through an initial setup for Wi-Fi connection again after you boot your phone.

Siri Eyes Free

You can talk to Siri using the  (Talk) button on the steering wheel when your iPhone is paired to the *Bluetooth*® HandsFreeLink® (HFL) system.

 **Phone Setup** P. 384

Using Siri Eyes Free

 **(Hang-up/back) Button**
Press to deactivate Siri.

Appears when Siri is activated in Siri Eyes Free

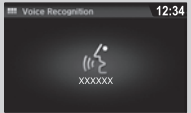

 **(Talk) Button**
Press and hold until the display changes as shown.

While in Siri Eyes Free:
The display remains the same.
No feedback or commands appears.

▶▶ Siri Eyes Free

Siri is a trademark of Apple Inc.

Check Apple Inc. website for features available for Siri.

While driving we recommend only using Siri through the  button on the steering wheel (Siri Eyes Free).

▶▶ Using Siri Eyes Free

Some commands work only on specific phone features or apps.

Apple CarPlay

If you connect an Apple CarPlay-compatible iPhone to the system via USB, you can use the audio/information touch screen, instead of the iPhone display, to make a phone call, listen to music, view maps (navigation), and access messages.

➤ **USB Port(s)** P. 201

Apple CarPlay Menu

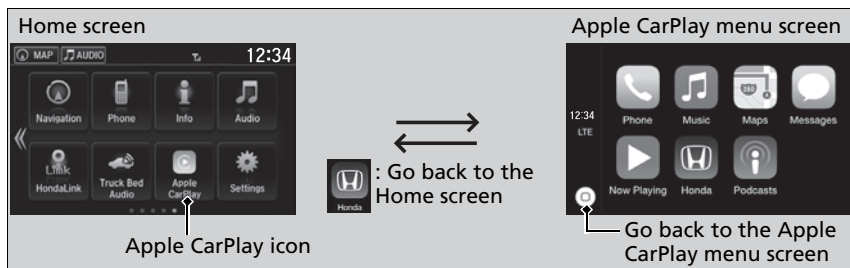

■ Phone

Access the contact list, make phone calls, or listen to voice mail.

■ Messages

Check and reply to text messages, or have messages read to you.

■ Music

Play music stored on your iPhone.

Apple CarPlay

Only iPhone 5 or newer versions with iOS 8.4 or later are compatible with Apple CarPlay.

Park in a safe place before connecting your iPhone to Apple CarPlay and when launching any compatible apps.

To use Apple CarPlay, connect the USB cable to the front USB port. The USB port located in the center console storage will not enable Apple CarPlay operation.

➤ **USB Port(s)** P. 201

To directly access the Apple CarPlay phone function, press **Phone** on the home screen. While connected to Apple CarPlay, calls are only made through Apple CarPlay. If you want to make a call with HandsFreeLink, turn Apple CarPlay OFF or detach the USB cable from your iPhone.

➤ **Setting Up Apple CarPlay** P. 287

When your iPhone is connected to Apple CarPlay, it is not possible to use the *Bluetooth*® Audio or *Bluetooth*® HandsFreeLink®. However, other previously paired phones can stream audio via *Bluetooth*® while Apple CarPlay is connected.

➤ **Phone Setup** P. 384

For details on countries and regions where Apple CarPlay is available, as well as information pertaining to function, refer to the Apple homepage.

■ Maps

Display Apple CarPlay map and use the navigation function just as you would on your iPhone.

Models with navigation system

Only one navigation system (pre-installed navigation or Apple CarPlay) can give directions at a time. When you are using one system, directions to any prior destination set on the other system will be canceled, and the system you are currently using will direct you to your destination.

■ Setting Up Apple CarPlay

After you have connected your iPhone to the system via USB, use the following procedure to set up Apple CarPlay. Use of Apple CarPlay will result in the transmission of certain user and vehicle information (such as vehicle location, speed, and status) to your iPhone to enhance the Apple CarPlay experience. You will need to consent to the sharing of this information on the Display Audio Screen.

■ Enabling Apple CarPlay

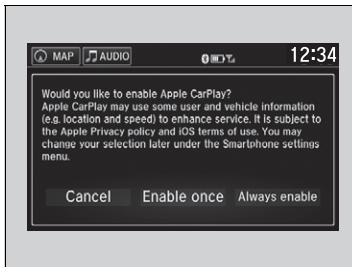

Cancel: Does not allow this consent.

Enable Once: Allows only once. (Prompt shows again next time.)

Always Enable: Allows anytime. (Prompt does not show again.)

You may change the consent settings under the **Smartphone** settings menu.

▶▶ Apple CarPlay

Apple CarPlay Operating Requirements & Limitations

Apple CarPlay requires a compatible iPhone with an active cellular connection and data plan. Your carrier's rate plans will apply.

Changes in operating systems, hardware, software, and other technology integral to providing Apple CarPlay functionality, as well as new or revised governmental regulations, may result in a decrease or cessation of Apple CarPlay functionality and services. Honda cannot and does not provide any warranty or guarantee of future Apple CarPlay performance or functionality.

It is possible to use 3rd party apps if they are compatible with Apple CarPlay. Refer to the Apple homepage for information on compatible apps.

▶▶ Setting Up Apple CarPlay

You can also use the method below to set up Apple CarPlay:
Select HOME→Settings→Smartphone→Apple CarPlay

Use of user and vehicle information

The use and handling of user and vehicle information transmitted to/from your iPhone by Apple CarPlay is governed by the Apple iOS terms and conditions and Apple's Privacy Policy.

■ Operating Apple CarPlay with Siri Eyes Free

Press and hold the talk button to activate Siri Eyes Free.



▣ Operating Apple CarPlay with Siri Eyes Free

Below are examples of questions and commands for Siri Eyes Free:

- What movies are playing today?
- Call dad at work.
- What song is this?
- How's the weather tomorrow?
- Read my latest email.
- Find a table for four tonight in Chicago.

For more information, please visit www.apple.com/ios/siri.

Android Auto

When you connect an Android phone to the Display Audio system via USB, Android Auto is automatically initiated. When connected via Android Auto, you can use the audio/information touch screen to access the Phone, Google Maps (Navigation), Google Play Music, and Google Now functions. When you first use Android Auto, a tutorial will appear on the screen.

We recommend that you complete this tutorial while safely parked before using Android Auto.

➤ **USB Port(s)** P. 201

➤ **Auto Pairing Connection** P. 291

Android Auto

To use Android Auto, you need to download the Android Auto app from Google Play to your smartphone.

Only Android 5.0 (Lollipop) or later versions are compatible with Android Auto.

Bluetooth A2DP cannot be used with Android Auto phone.

Park in a safe place before connecting your Android phone to Android Auto and when launching any compatible apps.

To use Android Auto, connect the USB cable to the front USB port. The USB port in the center console storage will not enable Android Auto operation.

➤ **USB Port(s)** P. 201

To directly access the Android Auto phone function, press **Phone** on the home screen.

➤ **Auto Pairing Connection** P. 291

When your Android phone is connected to Android Auto, it is not possible to use the *Bluetooth*® Audio. However, other previously paired phones can stream audio via *Bluetooth*® while Android Auto is connected.

➤ **Phone Setup** P. 384

Android Auto Menu

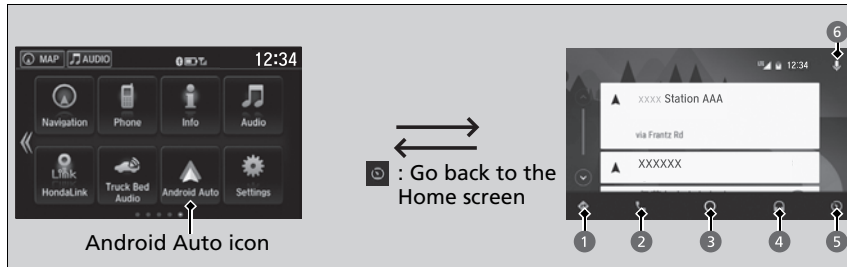

1 Maps (Navigation)

Display Google Maps and use the navigation function just as you would with your Android phone. When the vehicle is in motion, it is not possible to make keyboard entries. Stop the vehicle in a safe location to undertake a search or provide other inputs.

Models with navigation system

Only one navigation system (pre-installed navigation or Android Auto) can give directions at a time. When you are using one system, directions to any prior destination set on the other system will be canceled, and the system you are currently using will direct you to your destination.

The audio/Information screen shows you turn-by-turn driving directions to your destination.

2 Phone (Communication)

Make and receive phone calls as well as listen to voicemail.

3 Google Now (Home screen)

Display useful information organized by Android Auto into simple cards that appear just when they're needed.

Android Auto

For details on countries and regions where Android Auto is available, as well as information pertaining to function, refer to the Android Auto homepage.

Android Auto Operating Requirements & Limitations

Android Auto requires a compatible Android phone with an active cellular connection and data plan. Your carrier's rate plans will apply.

Changes in operating systems, hardware, software, and other technology integral to providing Android Auto functionality, as well as new or revised governmental regulations, may result in a decrease or cessation of Android Auto functionality and services. Honda cannot and does not provide any warranty or guarantee of future Android Auto performance or functionality.

It is possible to use 3rd party apps if they are compatible with Android Auto. Refer to the Android Auto homepage for information on compatible apps.

4 Music and audio

Play Google Play Music and music apps that are compatible with Android Auto.
To switch between music apps, press this icon.

5 Go back to the Home Screen.**6 Voice**

Operate Android Auto with your voice.

Auto Pairing Connection

When you connect an Android phone to the unit via USB, Android Auto is automatically initiated.

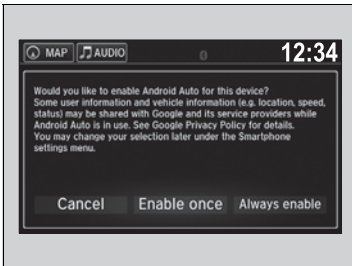
Enabling Android Auto

Cancel: Does not allow this consent.

Enable once: Allows only once. (Prompt shows again next time.)

Always enable: Allows anytime. (Prompt does not show again.)

You may change the consent settings under the **Smartphone** settings menu.

Enabling Android Auto

Only initialize Android Auto when you safely parked. When Android Auto first detects your phone, you will need to set up your phone so that auto pairing is possible. Refer to the instruction manual that came with your phone.

You can use the method below to change Android Auto settings after you have completed the initial setup:
Select HOME→Settings→Smartphone→Android Auto

Use of user and vehicle information

The use and handling of user and vehicle information transmitted to/from your phone by Android Auto is governed by the Google's Privacy Policy.

■ Operating Android Auto with Voice Recognition

Press and hold the talk button to operate Android Auto with your voice.



▣ Operating Android Auto with Voice Recognition

Below are examples of commands you can give with voice recognition:

- Reply to text.
- Call my wife.
- Navigate to Honda.
- Play my music.
- Send a text message to my wife.
- Call flower shop.

For more information, please refer to the Android Auto homepage.

You can also activate the voice recognition function by pressing the  icon in the upper-right corner of the screen.

Truck Bed Audio System*

When the vehicle is stopped or moving at speeds up to 9 mph (15 km/h), audio can be played from the truck bed.

Truck Bed Audio System Setup



1. Check that the shift lever is in **P**.
2. Select .
3. Select **Truck Bed Audio**.

4. Select **On** or **Off**.

Truck Bed Audio System*



After the setting has been completed, screen will time out in 30 seconds.

Audio Error Messages

Canadian models

CD Player

If a disc error occurs, you may see the following error messages.

Error Message	Cause	Solution
Unplayable File	Track/file format not supported	<ul style="list-style-type: none">• Current track/file will be skipped. The next supported track/file plays automatically.
Bad Disc Please check Owner's Manual Please push eject button	Mechanical error	<ul style="list-style-type: none">• Press the  (eject) button and remove the disc, and check that the error message is cleared.• Check that the disc is not damaged or deformed, and insert the disc again.<ul style="list-style-type: none">➤ Protecting CDs P. 300• If the error message reappears, press the  button, and pull out the disc.• Insert a different disc. If the new disc plays, there is a problem with the first disc.• If the error message repeats, or the disc cannot be removed, contact a dealer. Do not try to force the disc out of the player.
Mecha Error		
Bad Disc Please Check Owner's Manual	Servo error	<ul style="list-style-type: none">• If the error message reappears, press the  button, and pull out the disc.• Insert a different disc. If the new disc plays, there is a problem with the first disc.• If the error message repeats, or the disc cannot be removed, contact a dealer. Do not try to force the disc out of the player.
Check Disc	Disc error	<ul style="list-style-type: none">• Check that the disc is not damaged or deformed.<ul style="list-style-type: none">➤ Protecting CDs P. 300
Heat Error	High temperature	<ul style="list-style-type: none">• Turn the audio system off and allow the player to cool down until the error message is cleared.

iPod/USB Flash Drive

If an error occurs while playing an iPod or USB flash drive, you may see the following error messages. If you cannot clear the error message, contact a dealer.

Error Message	Solution
USB Error	Appears when there is a problem with the audio system. Check if the device is compatible with the audio system.
Bad USB Device ^{*1} The connected USB device has a problem. See Owner's Manual ^{*2}	Appears when an incompatible device is connected. Disconnect the device. Then turn the audio system off, and turn it on again. Do not reconnect the device that caused the error.
Unsupported Ver ^{*1} Unsupported Version ^{*2}	Appears when an unsupported iPod is connected. If it appears when a supported iPod is connected, update the iPod software to the newer version.
Connect Retry ^{*2}	Appears when the system does not acknowledge the iPod. Reconnect the iPod.
Unplayable File	Appears when the files in the USB flash drive are DRM or an unsupported format. This error message appears for about three seconds, then plays the next song.
No Data	<p>iPod Appears when the iPod is empty.</p> <p>USB flash drive Appears when the USB flash drive is empty or there are no MP3, WMA, or AAC files in the USB flash drive.</p> <p>iPod and USB flash drive Check that compatible files are stored on the device.</p>
Unsupported Ver ^{*1} Unsupported ^{*2}	Appears when an unsupported device is connected. If it appears when a supported device is connected, reconnect the device.

*1: Models with color audio system

*2: Models with Display Audio

Pandora®*

If an error occurs while playing Pandora®, you may see the following error messages.

If you cannot clear the error message, contact a dealer.

Error Message	Solution
To begin listening, create a new genre station.	Appears when there is no station list on the device. Use the device to create a station.
Unable to rate track. Please try again. Skip limit reached.	Appears when you try to skip a song or select Like/Dislike over the predetermined number of times in an hour.
Unable to play Pandora. Please try again later. Unable to retrieve a track explanation. Please try again later. Unable to create bookmark. Please try again later.	Appears when the commanded operation is failed. Try again later.
No Device Connected	Appears when no data is available with Pandora® activated. Reboot the app and reconnect the device.
Pandora App version is not supported	Appears when Pandora® version is not supported. Update Pandora® to the latest version.
Unable to complete the operation. Please try again later.	Appears when the Pandora® server is in maintenance. Try again later.
Unable to connect Pandora. When stopped, check your mobile phone.	Appears when Pandora® is unable to play music. Check your device.
	Appears when Pandora® app is not installed on your device. Install Pandora® app to the your device.

Models with Display Audio

Android/Apps

If an error occurs while using the audio system or apps, you may see the following error messages. If you cannot clear the error message, contact a dealer.

Error Message	Solution
Unfortunately, **** has stopped.* ¹	Error has occurred within app, select OK on the screen to close the app.
**** is not responding. Would you like to close it?*	App is not responding. Select Wait if you can wait for a response from app a little longer. If it does not respond even if you keep waiting, select OK to close the app and start it up. If the error message continues, perform Factory Data Reset .  Defaulting All the Settings P. 347

*1:****part is variable characters, and will change depending upon where an error occurs.

SiriusXM® Radio Service*

Subscribing to SiriusXM® Radio

1. You need your radio ID ready before registering for subscription. To see the ID in the screen, select **Channel** to 0.
2. Have your radio ID ready, and either call or visit the SiriusXM® website to subscribe.

Receiving SiriusXM® Radio

Switch to the SiriusXM® mode by using the **SOURCE** button on the steering wheel, or through the audio/information screen, and stay in this mode for about 30 minutes until the service is activated. Make sure your vehicle is in an open area with good reception.

SiriusXM® Radio Display Messages

Channel Not Subscribed:

You are not subscribed to the channel selected.

Subscription Update:

SiriusXM® radio is receiving information update from the network.

Channel Not Available:

No such channel exists, or the artist or title information is unavailable.

No Signal:

The signal is too weak in the current location.

Antenna Disconnected:

The SiriusXM® antenna is disconnected. Contact a dealer.

Subscribing to SiriusXM® Radio

Contact Information for SiriusXM® Radio:

- US: SiriusXM® Radio at www.sirius.com/subscribe-now, or 1-855-236-9236
- Canada: SiriusXM® Canada at www.sirius.ca/subscribe-now, or 1-877-209-0079

Receiving SiriusXM® Radio

The SiriusXM® satellites are in orbit over the equator; therefore, objects south of the vehicle may cause satellite reception interruptions. Satellite signals are more likely to be blocked by tall buildings and mountains the farther north you travel from the equator.

You may experience reception problems under the following circumstances:

- In a location with an obstruction to the south of your vehicle.
- In tunnels
- On the lower level of a multi-tiered road
- Large items carried on the roof rack

Canadian models

Recommended CDs

- Use only high-quality CD-R or CD-RW discs labeled for audio use.
- Use only CD-R or CD-RW discs on which the recordings are closed.
- Play only standard round-shaped CDs.

The CD packages or jackets should have one of these marks.



CDs with MP3, WMA or AAC files

- Some software files may not allow for audio play or text data display.
- Some versions of MP3, WMA or AAC formats may be unsupported.

Recommended CDs

A Dual-disc cannot play on this audio unit. If recorded under certain conditions, a CD-R or CD-RW may not play either.

■ Protecting CDs

Follow these precautions when handling or storing CDs:

- Store a CD in its case when it is not being played.
- When wiping a CD, use a soft clean cloth from the center to the outside edge.
- Handle a CD by its edge. Never touch either surface.
- Never insert foreign objects into the CD player.
- Keep CDs out of direct sunlight and extreme heat.
- Do not place stabilizer rings or labels on the CD.
- Avoid fingerprints, liquids, and felt-tip pens on the CD.

▶▶ Protecting CDs

NOTICE

Do not insert a damaged CD. It may be stuck inside and damage the audio unit.

Examples:

- Bubbled, wrinkled, labeled, and excessively thick CDs



Bubbled/
Wrinkled



With Label/
Sticker



Using
Printer Label
Kit



Sealed



With Plastic Ring

- Damaged CDs



Chipped/
Cracked

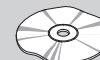

Warped

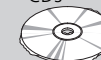

Burrs

- Poor quality CDs

- Small CDs



3-inch
(8-cm)
CD

Compatible iPod, iPhone, and USB Flash Drives

■ iPod and iPhone Model Compatibility

Model
iPod (5th generation)
iPod classic 80GB/160GB (launch in 2007)
iPod classic 120GB (launch in 2008)
iPod classic 160GB (launch in 2009)
iPod nano (1st to 7th generation*) launch in 2012
iPod touch (1st to 5th generation*) launch in 2012
iPhone 3G/iPhone 3GS/iPhone 4/iPhone 4s/iPhone 5*/iPhone 5c*/iPhone 5s*/iPhone6*

■ USB Flash Drives

- Use a recommended USB flash drive of 256 MB or higher.
- Some digital audio players may not be compatible.
- Some USB flash drives (e.g., a device with security lockout) may not work.
- Some software files may not allow for audio play or text data display.
- Some versions of MP3, WMA, or AAC formats may be unsupported.

*1: Models with Display Audio

* Not available on all models

⌘ iPod and iPhone Model Compatibility

This system may not work with all software versions of these devices.

⌘ USB Flash Drives

Files on the USB flash drive are played in their stored order. This order may be different from the order displayed on your PC or device.

Honda App License Agreement

■ END USER LICENSE AGREEMENT

PLEASE CAREFULLY READ THIS END USER LICENSE AGREEMENT (THIS "AGREEMENT") WHICH GOVERNS YOUR USE OF THE SOFTWARE INSTALLED ON YOUR HONDA OR ACURA VEHICLE (YOUR "VEHICLE") AS WELL AS THE APPLICATIONS, SERVICES, FUNCTIONS, AND CONTENT PROVIDED THROUGH THE SOFTWARE (COLLECTIVELY, THE "SERVICES"). YOUR USE OF THE SOFTWARE OR SERVICES WILL SERVE AS YOUR CONSENT TO THE TERMS OF THIS AGREEMENT. THE SOFTWARE IS OWNED (OR LICENSED), PROVIDED, AND/OR OPERATED BY AMERICAN HONDA MOTOR CO. INC., ("HONDA," "US," "WE," OR "OUR"), WITH ITS BUSINESS ADDRESS AT 1919 TORRANCE BLVD., TORRANCE, CA 90501. REFERENCE TO "HONDA" IN THIS AGREEMENT INCLUDES HONDA'S PARENT COMPANY AND ITS AFFILIATES AND DESIGNATED AGENTS. THE SERVICES ARE OWNED (OR LICENSED), PROVIDED, AND/OR OPERATED BY HONDA OR A THIRD-PARTY SERVICE PROVIDER (A "PROVIDER"). REFERENCE TO A "PROVIDER" IN THIS AGREEMENT INCLUDES SUCH PROVIDER'S PARENT COMPANY, AFFILIATES, AND DESIGNATED AGENTS.

A. Description of the Software. The SOFTWARE includes the software, firmware and the like, installed and executing on your VEHICLE during manufacture, and thereafter updated from time to time by HONDA, you or an authorized HONDA dealer (a "DEALER"). The SOFTWARE allows you to access and use a variety of SERVICES, including but not limited to: (a) HONDA applications, services, and content provided through the SOFTWARE (together, "HONDA SERVICES"); and (b) PROVIDER applications, services, and content provided through the SOFTWARE (together, "PROVIDER SERVICES"), each of which may provide access to various information, media, content, and services.

B. SOFTWARE Licensing and Intellectual Property.

1. SOFTWARE. This AGREEMENT grants you a non-exclusive, limited, and revocable license to use the SOFTWARE and SERVICES solely (a) as installed on your VEHICLE by HONDA, (b) as updated on your Vehicle by HONDA, you (but only as and when directed by HONDA), or a DEALER and (c) as permitted under the terms of this AGREEMENT.

2. HONDA Services. The SOFTWARE may provide you with access to various HONDA SERVICES. Installation, activation, or use of HONDA SERVICES may require your consent to additional terms, conditions, and privacy policies applicable to those HONDA SERVICES (the "HONDA TERMS"). You acknowledge and agree that any collection, use, sharing of data generated by your VEHICLE or your use of your VEHICLE, and your use of the HONDA SERVICES shall be subject to this AGREEMENT and any additional HONDA TERMS that may be specifically applicable to such HONDA SERVICES or data generation. The HONDA SERVICES may collect, use, and share such data while you are using the SOFTWARE.

3. Open-Source Software. The SOFTWARE and SERVICES may incorporate software licensed to HONDA under free or open-source licenses which govern HONDA's distribution and your use of such software. HONDA and the third-party authors, licensors, and distributors of such software disclaim all warranties and all liability arising from any and all use or distribution of the software. To the extent such software is provided under terms that differ from the applicable free or open-source licenses, those terms are offered by HONDA alone. Additional information regarding free and open-source software incorporated in the SOFTWARE and SERVICES is available in this manual or within the SOFTWARE.

4. Provider Services. The SOFTWARE may provide you with access to various PROVIDER SERVICES. Installation or use of such PROVIDER SERVICES may require your consent to additional terms, conditions, and privacy policies of the applicable PROVIDER (the "PROVIDER TERMS"). This AGREEMENT restricts the manner in which you can install and use PROVIDER SERVICES but does not grant you a license or permission to use such PROVIDER SERVICES. Your permission to use PROVIDER SERVICES is limited and subject to any license grants, conditions, and limitations included in the PROVIDER TERMS. You acknowledge that any collection, use, sharing of your information, targeted advertising practices by PROVIDERS, and your use of the PROVIDER SERVICES shall be subject to both this AGREEMENT and any applicable PROVIDER TERMS. The PROVIDER SERVICES may collect, use, and share such information while you are using the SOFTWARE.

5. License Limitations and Restrictions on Use.

(a) Limited License. You understand and agree that the SOFTWARE and SERVICES are licensed, not sold, to you solely for use in accordance with this AGREEMENT and any applicable PROVIDER TERMS, and any documentation for the VEHICLE made available to you by HONDA (any "DOCUMENTATION"). HONDA and its licensors reserve all rights in the SOFTWARE and HONDA SERVICES not expressly granted to you under this AGREEMENT. PROVIDERS and their licensors reserve all rights in the PROVIDER SERVICES not expressly granted to you under the applicable PROVIDER TERMS.

(b) Restrictions on Use. The licenses granted under this AGREEMENT do not permit you to use the SOFTWARE or SERVICES on a device other than your VEHICLE. As a condition of using the SOFTWARE and SERVICES, you agree that you may not and will not:

- (1) copy, download, distribute, modify, publish, sell, rent, lease, lend, license, sublicense, reuse, or create derivative works of the SOFTWARE or SERVICES or any of the content or other material within the SOFTWARE or SERVICES, including without limitation, HONDA or PROVIDER names, logos, or any other trademarks of HONDA or PROVIDERS or used in association with the SOFTWARE or any SERVICES, except as required to use the SOFTWARE or SERVICES in accordance with this AGREEMENT, any applicable PROVIDER TERMS, and the DOCUMENTATION;
- (2) access or use the SOFTWARE or SERVICES in any manner intended to damage or impair the operation of the SOFTWARE or SERVICES or interfere with anyone else's use and enjoyment of the SOFTWARE or SERVICES;
- (3) access or attempt to access any system or server on which the SOFTWARE or SERVICES is hosted or modify or alter the SOFTWARE or SERVICES in any way;
- (4) use the SOFTWARE or SERVICES for any unlawful purpose, or in violation of any third party rights;
- (5) use the SOFTWARE or SERVICES in violation of any applicable traffic regulations, rules or laws, including but not limited to any driver distraction laws, rules or regulations;
- (6) violate the terms of this AGREEMENT, any HONDA TERMS, any PROVIDER TERMS or other applicable third-party terms, conditions, and privacy policies; or
- (7) reverse engineer, decompile, disassemble, attempt to derive the source code of, nor permit others to reverse engineer, decompile, or disassemble, or attempt to derive the source code of the SOFTWARE or SERVICES, except and only to the extent that such activity is expressly permitted (a) by applicable law notwithstanding this limitation or (b) the terms of applicable free or opensource software licenses.

6. Intellectual Property Rights. All title and intellectual property rights in and to the SOFTWARE and SERVICES, the accompanying DOCUMENTATION, and all copies of the SOFTWARE or SERVICES are owned by HONDA, PROVIDERS, or their suppliers or licensors. This AGREEMENT does not grant you any rights in connection with any trademarks or service marks of HONDA, PROVIDERS, or their licensors, affiliates, or suppliers.

7. Export Restrictions: You acknowledge that the SOFTWARE and SERVICES are subject to U.S., European Union, and other export jurisdictions. You agree to comply with all applicable international and national laws that apply to the SOFTWARE and SERVICES, including the U.S. Export Administration Regulations, as well as end-user, end-use, and destination restrictions issued by the U.S. and other governments.

C. SOFTWARE Operation

- 1.** HONDA reserves the right to suspend or terminate your access to and use of the SOFTWARE or SERVICES if you are found to be in violation of this AGREEMENT or as reasonably deemed necessary by HONDA.
- 2. Eligibility/Registration/Activation.** The SOFTWARE is intended for and available to individuals who (a) are of legal age of majority in their jurisdiction of residence (and at least 18 years of age), or are younger than 18 years of age and possess a valid driver's license issued by their jurisdiction of residence, and (b) own or have permissive access to a compatible VEHICLE. We do not knowingly collect any information, including personal information, from children under 13. If we learn or are notified that we have collected personal information of a child under 13, we will immediately take steps to delete such information.
- 3. Use of PROVIDER SERVICES through the SOFTWARE.** Certain PROVIDER SERVICES made available through the SOFTWARE may require that you register or otherwise have an account with the PROVIDER and agree to PROVIDER TERMS. Any use of any of such PROVIDER SERVICES within the SOFTWARE is subject to this AGREEMENT and the applicable PROVIDER TERMS. HONDA does not exercise control over such PROVIDER SERVICES and is not responsible or liable for the availability, security, or content of such PROVIDER SERVICES, and the inclusion of any PROVIDER SERVICES does not imply a referral from, the approval of, or the endorsement by HONDA of such PROVIDER SERVICES. HONDA is not responsible or liable, directly or indirectly, for any damage relating to or resulting from your use of the PROVIDER SERVICES.
- 4. Links to Third Party Sites:** The SOFTWARE may provide you with the ability to access third-party sites and content through the use of the SOFTWARE or SERVICES. The third-party sites and content are not under the control of HONDA. HONDA is not responsible or liable, directly or indirectly, for such third-party websites and their content or for any damage relating to or resulting from your access or use of such websites and content.

5. Unauthorized Use and Abuse. You are responsible for ensuring your (and any authorized third parties') use of the SOFTWARE and SERVICES remains in compliance with this AGREEMENT and all other applicable HONDA TERMS and PROVIDER TERMS. You acknowledge and agree that any use of the SOFTWARE or SERVICES occurring through your VEHICLE will be deemed your actions and that HONDA and PROVIDERS may rely upon such actions. You agree to immediately notify us if you suspect fraudulent or abusive activity involving the SOFTWARE or SERVICES. If you so notify us or if we otherwise suspect fraudulent or abusive activity, you agree to cooperate with us in any fraud investigation and to use any fraud prevention measures we prescribe. Your failure to immediately notify us or cooperate to use such measures will result in your liability for all fraudulent usage or abusive activity associated with your VEHICLE.

6. SOFTWARE Updates. The SOFTWARE and SERVICES may be updated when your VEHICLE is serviced by a DEALER or remotely, over-the-air, by HONDA from time to time; such updates may occur with or without further notice or your future consent. The SOFTWARE may be updated at HONDA's discretion and for any purpose including, without limitation, to patch or otherwise improve the SOFTWARE or SERVICES functionality, security, or stability. All updates to the SOFTWARE and SERVICES are subject to this AGREEMENT and any other applicable HONDA TERMS and PROVIDER TERMS.

7. Uninstalling, Removing, and Replacing the SOFTWARE. Replacing SOFTWARE or HONDA SERVICES with software or firmware not provided and installed by HONDA or a DEALER will render all representations and warranties for the SOFTWARE, HONDA SERVICES, and VEHICLE functionality reliant upon the SOFTWARE or HONDA SERVICES null and void.

D. SOFTWARE Operational Notices and Warnings

1. Vehicle Geolocation Information. You acknowledge that your VEHICLE may be equipped with certain traffic and map features. The traffic feature will automatically collect and transmit, through GPS technology, your Vehicle's current location (longitude and latitude), travel direction and speed ("VEHICLE GEOLOCATION INFORMATION") to HONDA and PROVIDERS. The VEHICLE GEOLOCATION INFORMATION is used by HONDA and PROVIDERS to provide traffic and navigation-related information to you, but may also be used to provide other SERVICES or offers to you. HONDA will not use such VEHICLE GEOLOCATION INFORMATION for its own marketing efforts, or provide such information to unaffiliated third parties for their own purposes, without your express consent.

2. Potential Map Inaccuracy and Route Safety. Maps used by this system may be inaccurate because of changes in roads, traffic controls, routing, or driving conditions. Always use good judgment and common sense when following suggested routes. Do not follow the route suggestions if doing so would result in an unsafe or illegal driving maneuver, if you would be placed in an unsafe situation, or if you would be directed into an area that you consider unsafe. Do not rely on any navigation features included in the system to route you to emergency services. Not all emergency services such as police, fire stations, hospitals, or clinics are likely to be contained in the map database for such navigation features. Ask local authorities or an emergency services operator for such locations and routes. The driver is ultimately responsible for the safe operation of the vehicle and therefore, must evaluate whether it is safe to follow the suggested directions. Any navigation features are provided only as an aid. Make your driving decisions based on your observations of local conditions and existing traffic regulations. Navigation features are not a substitute for your personal judgment. Any route suggestions made by the SOFTWARE or SERVICES should never replace any local traffic regulations or your personal judgment or knowledge of safe driving practices.

3. Speech Recognition: You acknowledge and understand that HONDA and PROVIDERS may record, retain, and use voices commands when you use the speech recognition components of the SOFTWARE or SERVICES. You and all VEHICLE operators and passengers (a) consent to the recording and retention of voice commands in support of providing speech recognition components and (b) release HONDA and PROVIDERS from all claims, liabilities, and losses that may result from any use of such recorded voice commands. Recognition errors are inherent in speech recognition. It is your responsibility to monitor any speech recognition functions included in the system and address any errors. Neither HONDA nor PROVIDERS will be liable for any damages arising out of errors in the speech recognition process.

4. Distraction Hazards. Navigation features may require manual (non-verbal) input or setup. Attempting to perform such set-up or insert data while driving can seriously distract your attention and could cause a crash or other serious consequences; the ability to undertake such interactions may also be limited by state or local law, which laws you are responsible to know and follow. Even occasional short scans of the screen may be hazardous if your attention has been diverted away from your driving at a critical time. Pull over and stop the vehicle in a safe and legal manner before attempting to access a function of the system requiring prolonged attention. Do not raise the volume excessively. Keep the volume at a level where you can still hear outside traffic and emergency signals while driving. Driving while unable to hear these sounds could result in a crash.

E. Information Collection and Storage

1. Information Collection, Use, Transmission and Storage of Data. Consent to Use of Data: You agree that HONDA and PROVIDERS may collect and use your information gathered in any manner as part of product support services related to the SOFTWARE or related services. HONDA may share such information with third parties, including, without limitation, PROVIDERS, third party software and services suppliers, their affiliates and/or their designated agents, solely to improve their products or to provide services or technologies to you. HONDA, third party software and systems suppliers, their affiliates and/or their designated agent may disclose this information to others, but not in a form that personally identifies you.

2. Information Storage. Depending on the type of multimedia system you have in your VEHICLE, certain information may be stored for ease of use of the SOFTWARE including, without limitation, search history, location history in certain applications, previous and saved destinations, map locations within certain applications, and device numbers and contact information.

(a) Vehicle Health Information. Your VEHICLE may remotely transmit information regarding the status and health of your VEHICLE (“VEHICLE INFORMATION”) to HONDA without notification to you. VEHICLE INFORMATION may contain VEHICLE maintenance and malfunction status that is derived from VEHICLE diagnostic data and includes, but is not limited to, status of powered doors and windows, battery life data, battery charging data, VEHICLE speed, coolant temperature, air compressor revolution, output power, warning codes, diagnostic trouble codes, fuel injection volume, and engine rotations per minute. VEHICLE HEALTH INFORMATION may be used by HONDA for research and development, to deliver HONDA SERVICES and information to you, and to contact you, and is retained only for a period of time necessary to fulfill these goals.

(b) VEHICLE Geolocation Data (non-navigation/map based). If you opt-in to geolocation-based SERVICES, your vehicle’s geolocation data (latitude and longitude) will be automatically sent from your VEHICLE to HONDA and PROVIDERS.

(c) You understand that the inputting or uploading of information to your VEHICLE’s multimedia system or the SOFTWARE or SERVICES is at your own risk and that HONDA is not responsible for unauthorized access to or use of any personal or other information. All information uploaded to the SOFTWARE and SERVICES may be stored on your VEHICLES’s multimedia system and you understand that the security and safety of your VEHICLE’s multimedia system is your sole responsibility.

F. NO WARRANTY. You understand and agree that your use of the SOFTWARE and SERVICES are solely at your own risk and that you will be solely responsible for any damage to your VEHICLE's multimedia system or any other equipment or any loss of data that may result from your use of the SOFTWARE or SERVICES. THE SOFTWARE AND SERVICES ARE PROVIDED ON AN "AS IS" AND "AS AVAILABLE" BASIS WITHOUT ANY WARRANTY OF ANY KIND, EXPRESSED, IMPLIED OR STATUTORY. WE SPECIFICALLY DISCLAIM ANY IMPLIED WARRANTIES OF MERCHANTABILITY, FITNESS FOR A PARTICULAR PURPOSE, AND NON-INFRINGEMENT. HONDA makes no warranties that the SOFTWARE or SERVICES will meet your requirements, or that the SOFTWARE or SERVICES will be uninterrupted, timely, secure, non-infringing or error free. You understand and agree that you are responsible for any and all charges, costs or expenses associated with your use of the SOFTWARE or SERVICES. Advice or information, whether oral or written, obtained by you from us or through the SOFTWARE or SERVICES are provided for informational purposes only and will not create any warranty not expressly made herein. You should not rely on any such information or advice. We assume no liability or responsibility for any errors or omissions in the SOFTWARE or SERVICES. We do not make any warranty or representation that your use of the material displayed on, or obtained through, the SOFTWARE or SERVICES is non-infringing of any rights of any third party. Any decision or action taken by you on the basis of information or content provided via the application is at your sole discretion and risk. HONDA and PROVIDERS are not responsible or liable for any such decision, or for the accuracy, completeness, usefulness, or availability of any content or information displayed, transmitted, or otherwise made available via the SOFTWARE or SERVICES. To the extent jurisdictions do not allow the exclusion of certain warranties, some of the above exclusions may not apply to you.

G. LIMITATIONS ON LIABILITY. You and HONDA are each waiving important rights.

1. Limitations on YOUR liability. HONDA cannot recover from you any consequential, indirect, incidental, or special damages, or attorney's fees in connection with your use of the SOFTWARE or HONDA SERVICES. HONDA WAIVES TO THE FULLEST EXTENT ALLOWED BY LAW ANY CLAIM FOR DAMAGES OTHER THAN DIRECT, COMPENSATORY DAMAGES AS LIMITED IN THIS AGREEMENT.

2. Limitation on HONDA and PROVIDER liability. Neither HONDA nor PROVIDERS will be liable to you or any other party for consequential, indirect, incidental, special, or punitive damages (including without limitation lost profits) in connection with your use of the SOFTWARE or SERVICES, even if HONDA or PROVIDERS are aware of the possibility of such damages. These limitations apply to all claims, including, without limitation, claims in contract and tort (such as negligence, product liability and strict liability). To the extent that a jurisdiction does not permit the exclusion or limitation of liability as set forth herein our liability is limited to the maximum extent permitted by law in such states. If HONDA or PROVIDERS are found liable to you for any reason, you agree that the aggregate liability of all these parties to you for any claim is limited to ten U.S. dollars (US \$10.00). Neither HONDA nor any PROVIDER would have agreed to provide the SOFTWARE or SERVICES to you if you did not agree to this limitation. This amount is the sole and exclusive liability of HONDA and PROVIDERS to you, and is payable as liquidated damages and not as a penalty. Except where prohibited by law, you may not bring any claim against HONDA or any third-party beneficiary more than two (2) years after the claim arises. We do not have any liability for SOFTWARE or SERVICES interruptions of any length.

(a) **Release of HONDA and PROVIDERS** For yourself and anyone else claiming under you, you agree to release and discharge HONDA, PROVIDERS, their respective officers, directors, and employees, and each third-party beneficiary from all claims, liabilities and losses in connection with the SOFTWARE or SERVICES, including, but not limited to claims for personal injury or property damage arising from the total or partial failure of performance of the SOFTWARE or SERVICES, even if caused by or based upon the negligence, gross negligence, strict products liability, Deceptive Trade Practices Act violations, bad faith, or breach of warranty of us or the malfunction of the SOFTWARE or SOFTWARE SERVICES. YOU AGREE TO WAIVE TO THE FULLEST EXTENT ALLOWED BY LAW, ANY CLAIM FOR DAMAGES OTHER THAN DIRECT, COMPENSATORY DAMAGES AS LIMITED IN THIS AGREEMENT. YOU HEREBY RELEASE AND DISCHARGE HONDA AND ITS LICENSORS AND CONTRACTORS (INCLUDING ANY THIRD PARTIES PROVIDING ALL OR PART OF THE SOFTWARE OR SERVICES) FROM AND AGAINST ANY CLAIMS, DAMAGES, EXPENSES AND LIABILITY ARISING FROM OR RELATED TO ANY INJURIES, DAMAGES, OR LOSSES TO ANY PERSON (INCLUDING DEATH) OR PROPERTY OF ANY KIND RESULTING IN WHOLE OR PART, DIRECTLY OR INDIRECTLY, FROM YOUR USE OF THE SOFTWARE OR SERVICES.

H. Survival. You agree that the limitations of liability and indemnities in this AGREEMENT will survive even after the AGREEMENT has ended. These limitations of liability apply not only to you, but to anyone using the SOFTWARE or SERVICES via your VEHICLE, to anyone making a claim on your behalf, and to any claims made by your family, employees, customers, or others arising out of or relating to your VEHICLE, the SOFTWARE, or SERVICES.

I. Availability/Interruption. The SOFTWARE and certain SERVICES are made available through your VEHICLE's compatible multimedia system when the VEHICLE is turned on. Certain SERVICES may be available only through your compatible mobile device when it is within the operating range of the VEHICLE and a wireless carrier. The availability of the SOFTWARE and SERVICES may be subject to transmission limitation or interruption, including but not limited to technical obsolescence or sunset of the hardware, software or firmware, inside of or external to the Vehicle, required for data transmission or receipt. HONDA does not guarantee that the SOFTWARE, SERVICES, or any portion thereof will be available at all times or in all areas. You acknowledge and agree that HONDA is not responsible for performance degradation, interruption or delays. You acknowledge that HONDA shall not be liable to you if the SOFTWARE or SERVICES in a given location are not available. If the SOFTWARE or SERVICES are not available within your intended location, you agree that your sole remedy shall be to cease using the SOFTWARE and SERVICES.

J. PRODUCT SUPPORT: Product support for the SOFTWARE is provided by HONDA. For product support, please refer to HONDA instructions provided in the DOCUMENTATION. Should you have any questions concerning this AGREEMENT, or if you desire to contact HONDA for any other reason, please refer to the HONDA contact information provided in the DOCUMENTATION.

K. Termination and Transfer.

1. Termination. This AGREEMENT is effective until terminated by you or US. WE may terminate this AGREEMENT for any or no reason, and with or without notice to you. Your rights under this AGREEMENT will terminate automatically without notice from US if you fail to comply with any term of this AGREEMENT. Upon termination of this AGREEMENT, you shall cease all use of the SOFTWARE and SERVICES.

2. Transfer: You may permanently transfer your rights under this AGREEMENT only as part of a sale or transfer of the VEHICLE, provided you retain no copies, you transfer all of the SOFTWARE and HONDA SERVICES (including all component parts, the media and printed materials, and any upgrades), and the recipient agrees to the terms of this AGREEMENT. You agree to notify HONDA upon the sale or transfer of the VEHICLE. To contact HONDA, please refer to the HONDA contact information provided in the DOCUMENTATION.

L. Changes to the SOFTWARE or SERVICES. WE may change, modify, or update the SOFTWARE or SERVICES from time to time. Unless explicitly stated otherwise, any new features or services that augment or enhance the SOFTWARE or SERVICES in the future shall respectively be considered part of the SOFTWARE or SERVICES and subject to this AGREEMENT. WE reserve the right at any time and from time to time to interrupt, restrict, modify, suspend, discontinue, temporarily or permanently, the SOFTWARE or SERVICES (or any portion thereof), with or without notice to you, and you agree that HONDA shall not be liable to you or to any third party for any modification, suspension or discontinuance of the SOFTWARE or SERVICES.

M. ARBITRATION:

PLEASE READ THIS ARBITRATION PROVISION CAREFULLY TO UNDERSTAND YOUR RIGHTS. YOU AGREE THAT ANY CLAIM THAT YOU MAY HAVE IN THE FUTURE MUST BE RESOLVED THROUGH BINDING ARBITRATION. YOU WAIVE THE RIGHT TO HAVE YOUR DISPUTE HEARD IN COURT AND WAIVE THE RIGHT TO BRING CLASS CLAIMS. YOU UNDERSTAND THAT DISCOVERY AND APPEAL RIGHTS ARE MORE LIMITED IN ARBITRATION.

Arbitration is a method of resolving a claim, dispute or controversy without filing a lawsuit. By agreeing to arbitrate, the right to go to court is waived and instead claims, disputes or controversies are submitted to binding arbitration. This provision sets forth the terms and conditions of our agreement. YOU and HONDA agree and acknowledge that this Agreement affects interstate commerce and the Federal Arbitration Act ("FAA") applies. By using the Software, Vehicle, or Services, YOU elect to have disputes resolved by arbitration. YOU, HONDA or any involved third party may pursue a Claim. "Claim" means any dispute between YOU, HONDA, or any involved third party relating to your use of the Software, the Vehicle, or the Services, this Agreement, or our relationship, including any representations, omissions or warranties. "Claim" does not include personal injury or wrongful death claims. YOU or HONDA may seek remedies in small claims court or provisional judicial remedies without arbitrating. In addition, notwithstanding anything herein to the contrary, YOU or HONDA may seek equitable relief in a court of competent jurisdiction.

YOU or HONDA may select arbitration with American Arbitration Association, JAMS or National Arbitration and Mediation. Contact these sponsors for their rules. The hearing will be in the federal district where YOU reside. If agreed, it may be by telephone or written submissions. Filing and arbitrator fees to be paid per the sponsor rules. You may contact the sponsor for a fee waiver. If no fee waivers, HONDA will pay filing and arbitrator fees up to \$5,000, unless law requires more. Each party is responsible for other fees. Arbitrator may award costs or fees to prevailing party, if permitted by law. HONDA will not seek fees, unless the claims are frivolous.

Arbitrator shall be an attorney or current or retired judge familiar with automotive or consumer software. The arbitrator shall follow substantive law, statute of limitations and decide all issues relating to the interpretation, construction, enforceability and applicability of this provision. The arbitrator may order relief permitted by law. This provision is governed and enforceable by the FAA. An award shall include a written opinion and be final, subject to appeal by the FAA.

This provision survives termination of this Agreement or relationship, bankruptcy, assignment or transfer. If part of this provision is unenforceable, the remainder remains in effect. If unenforceability allows arbitration as a class action, then this provision is entirely unenforceable. YOU may opt out within 30 days of your initial use of the Software by sending a signed, written notice to HONDA at Honda Financial Services, P.O. Box 165007, Irving, TX 75016. HONDA reserves the right to make changes to this provision after providing written notice and an opportunity to opt out.

N. Miscellaneous: You may not assign this AGREEMENT without HONDA's prior written consent. This AGREEMENT and any additional HONDA TERMS and PROVIDER TERMS represents the entire agreement between you and US. HONDA may amend the terms of this AGREEMENT by providing you with notices of such updated terms. If you do not consent to be bound by the updated terms, your sole remedy will be to cease using the SOFTWARE and SERVICES. If any part of this AGREEMENT is found invalid, void, or unenforceable, the balance of the AGREEMENT will remain valid and enforceable according to its terms. To the fullest extent permitted by law, and except as explicitly provided otherwise, this AGREEMENT and any disputes arising out of or relating to it will be governed by the laws of the State of California, except that California laws concerning choice of law or conflicts shall not apply if they would cause the substantive law of another jurisdiction to apply. Notwithstanding the foregoing, Section M shall be governed by the Federal Arbitration Act and the laws of the State of California, as applicable, as set forth therein. The failure to enforce any term of this AGREEMENT on one occasion shall not prevent enforcement on any other occasion or the enforcement of any other term. Headings and captions shall not be considered included for purposes of interpretation or application hereof, but are for convenience only.

Models with Display Audio

Legal Information on Apple CarPlay/Android Auto

OWNER'S MANUAL LICENSE/LIABILITY STATEMENTS

USE OF APPLE CARPLAY IS SUBJECT TO YOUR AGREEMENT TO THE CARPLAY TERMS OF USE, WHICH ARE INCLUDED AS PART OF THE APPLE iOS TERMS OF USE. IN SUMMARY, THE CARPLAY TERMS OF USE DISCLAIM APPLE AND ITS SERVICE PROVIDERS' LIABILITY IF THE SERVICES FAIL TO PERFORM CORRECTLY OR ARE DISCONTINUED, STRICTLY LIMIT APPLE AND ITS SERVICE PROVIDERS' OTHER LIABILITIES, DESCRIBE THE KINDS OF USER INFORMATION (INCLUDING, FOR EXAMPLE, VEHICLE LOCATION, VEHICLE SPEED, AND VEHICLE STATUS) BEING GATHERED AND STORED BY APPLE AND ITS SERVICE PROVIDERS, AND DISCLOSE CERTAIN POSSIBLE RISKS ASSOCIATED WITH THE USE OF CARPLAY, INCLUDING THE POTENTIAL FOR DRIVER DISTRACTION. SEE APPLE'S PRIVACY POLICY FOR DETAILS REGARDING APPLE'S USE AND HANDLING OF DATA UPLOADED BY CARPLAY.

USE OF ANDROID AUTO IS SUBJECT TO YOUR AGREEMENT TO THE ANDROID AUTO TERMS OF USE WHICH MUST BE AGREED TO WHEN THE ANDROID AUTO APPLICATION IS DOWNLOADED TO YOUR ANDROID PHONE. IN SUMMARY, THE ANDROID AUTO TERMS OF USE DISCLAIM GOOGLE AND ITS SERVICE PROVIDERS' LIABILITY IF THE SERVICES FAIL TO PERFORM CORRECTLY OR ARE DISCONTINUED, STRICTLY LIMIT GOOGLE AND ITS SERVICE PROVIDERS' OTHER LIABILITIES, DESCRIBE THE KINDS OF USER INFORMATION (INCLUDING, FOR EXAMPLE, VEHICLE LOCATION, VEHICLE SPEED, AND VEHICLE STATUS) BEING GATHERED AND STORED BY GOOGLE AND ITS SERVICE PROVIDERS, AND DISCLOSE CERTAIN POSSIBLE RISKS ASSOCIATED WITH THE USE OF ANDROID AUTO, INCLUDING THE POTENTIAL FOR DRIVER DISTRACTION. SEE GOOGLE'S PRIVACY POLICY FOR DETAILS REGARDING GOOGLE'S USE AND HANDLING OF DATA UPLOADED BY ANDROID AUTO.

DISCLAIMER OF WARRANTIES; LIMITATION ON LIABILITY

YOU EXPRESSLY ACKNOWLEDGE AND AGREE THAT USE OF APPLE CARPLAY OR ANDROID AUTO (“THE APPLICATIONS”) IS AT YOUR SOLE RISK AND THAT THE ENTIRE RISK AS TO SATISFACTORY QUALITY, PERFORMANCE, ACCURACY AND EFFORT IS WITH YOU TO THE MAXIMUM EXTENT PERMITTED BY APPLICABLE LAW, AND THAT THE APPLICATIONS AND INFORMATION ON THE APPLICATIONS IS PROVIDED “AS IS” AND “AS AVAILABLE,” WITH ALL FAULTS AND WITHOUT WARRANTY OF ANY KIND, AND HONDA HEREBY DISCLAIMS ALL WARRANTIES AND CONDITIONS WITH RESPECT TO THE APPLICATIONS AND INFORMATION ON THE APPLICATIONS, EITHER EXPRESS, IMPLIED OR STATUTORY, INCLUDING, BUT NOT LIMITED TO, THE IMPLIED WARRANTIES AND/OR CONDITIONS OF MERCHANTABILITY, SATISFACTORY QUALITY, FITNESS FOR A PARTICULAR PURPOSE, ACCURACY, QUIET ENJOYMENT, AND NON-INFRINGEMENT OF THIRD PARTY RIGHTS. NO ORAL OR WRITTEN INFORMATION OR ADVICE GIVEN BY HONDA OR AN AUTHORIZED REPRESENTATIVE SHALL CREATE A WARRANTY. AS EXAMPLES, AND WITHOUT LIMITATION, HONDA DISCLAIMS ANY WARRANTY REGARDING THE ACCURACY OF DATA PROVIDED BY THE APPLICATIONS, SUCH AS THE ACCURACY OF DIRECTIONS, ESTIMATED TRAVEL TIME, SPEED LIMITS, ROAD CONDITIONS, NEWS, WEATHER, TRAFFIC, OR OTHER CONTENT PROVIDED BY APPLE, GOOGLE, THEIR AFFILIATES, OR THIRD PARTY PROVIDERS; HONDA DOES NOT GUARANTEE AGAINST LOSS OF APPLICATION DATA, WHICH MAY BE LOST AT ANY TIME; HONDA DOES NOT GUARANTEE THAT THE APPLICATIONS OR ANY SERVICES PROVIDED THROUGH THEM WILL BE PROVIDED AT ALL TIMES OR THAT ANY OR ALL SERVICES WILL BE AVAILABLE AT ANY PARTICULAR TIME OR LOCATION. FOR EXAMPLE, SERVICES MAY BE SUSPENDED OR INTERRUPTED WITHOUT NOTICE FOR REPAIR, MAINTENANCE, SECURITY FIXES, UPDATES, ETC., SERVICES MAY BE UNAVAILABLE IN YOUR AREA OR LOCATION, ETC. IN ADDITION, YOU UNDERSTAND THAT CHANGES IN THIRD PARTY TECHNOLOGY OR GOVERNMENT REGULATION MAY RENDER THE SERVICES AND/OR APPLICATIONS OBSOLETE AND/OR UNUSABLE.

TO THE EXTENT NOT PROHIBITED BY LAW, IN NO EVENT SHALL HONDA OR ITS AFFILIATES BE LIABLE FOR PERSONAL INJURY, OR ANY INCIDENTAL, SPECIAL, INDIRECT OR CONSEQUENTIAL DAMAGES WHATSOEVER, INCLUDING, WITHOUT LIMITATION, DAMAGES FOR LOSS OF PROFITS, CORRUPTION OR LOSS OF DATA, FAILURE TO TRANSMIT OR RECEIVE ANY DATA, BUSINESS INTERRUPTION OR ANY OTHER COMMERCIAL DAMAGES OR LOSSES, ARISING OUT OF OR RELATED TO THE APPLICATIONS OR YOUR USE OF OR INABILITY TO USE THE APPLICATIONS OR INFORMATION ON THE APPLICATIONS, HOWEVER CAUSED, REGARDLESS OF THE THEORY OF LIABILITY (CONTRACT, TORT OR OTHERWISE) AND EVEN IF HONDA WERE ADVISED OF THE POSSIBILITY OF SUCH DAMAGES. SOME STATES AND JURISDICTIONS DISALLOW THE EXCLUSION OR LIMITATION OF LIABILITY FOR DAMAGES, SO THESE LIMITATIONS AND EXCLUSIONS MAY NOT APPLY TO YOU. IN NO EVENT SHALL HONDA’S TOTAL LIABILITY TO YOU FOR ALL DAMAGES (OTHER THAN AS MAY BE REQUIRED BY APPLICABLE LAW IN CASES INVOLVING PERSONAL INJURY) EXCEED THE AMOUNT OF FIVE DOLLARS (\$5.00). THE FOREGOING LIMITATIONS WILL APPLY EVEN IF THE ABOVE STATED REMEDY FAILS OF ITS ESSENTIAL PURPOSE.

Models with Display Audio

About Open Source Licenses

To see the open source license information, follow these steps.

1. Select .
2. Select **Settings**.
3. Select **System**, then open the **Others** tab.
4. Select **Detail Information**.
5. Select **About device**.
6. Select **Legal information**.
7. Select **Open source licenses**.

Customized Features

Use the audio/information screen to customize certain features.

Models with color audio system

How to customize

While the vehicle is at a complete stop with the power ON, press the **MENU/CLOCK** button, then select **Settings**. To customize the phone settings, press the  button, then select **Phone Setup**.

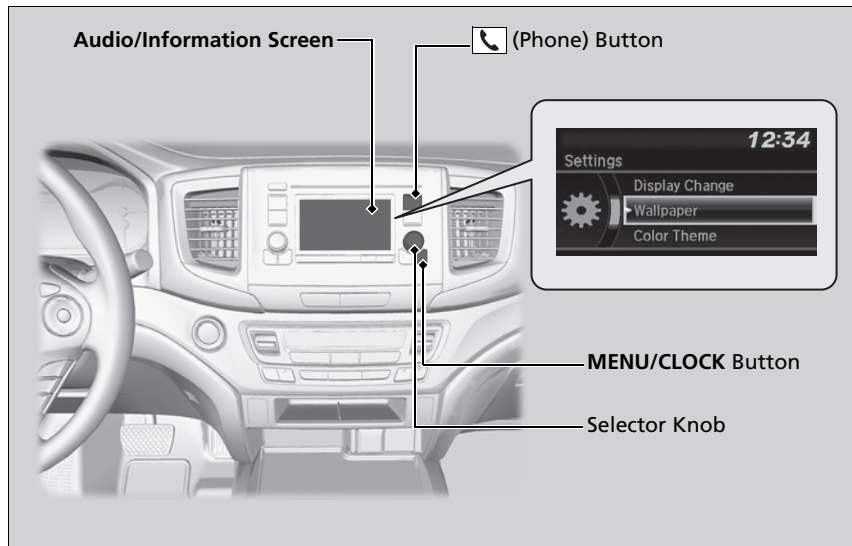

Customized Features



When you customize settings, make sure that the vehicle is at a complete stop and shift to **P**.

How to customize

These indications are used to show how to operate the selector knob.

Rotate  to select.

Press  to enter.

To customize other features, select **Settings**, rotate , then press .

 **List of customizable options** P. 320

Continued

■ Customization Flow

Press the MENU/CLOCK button.

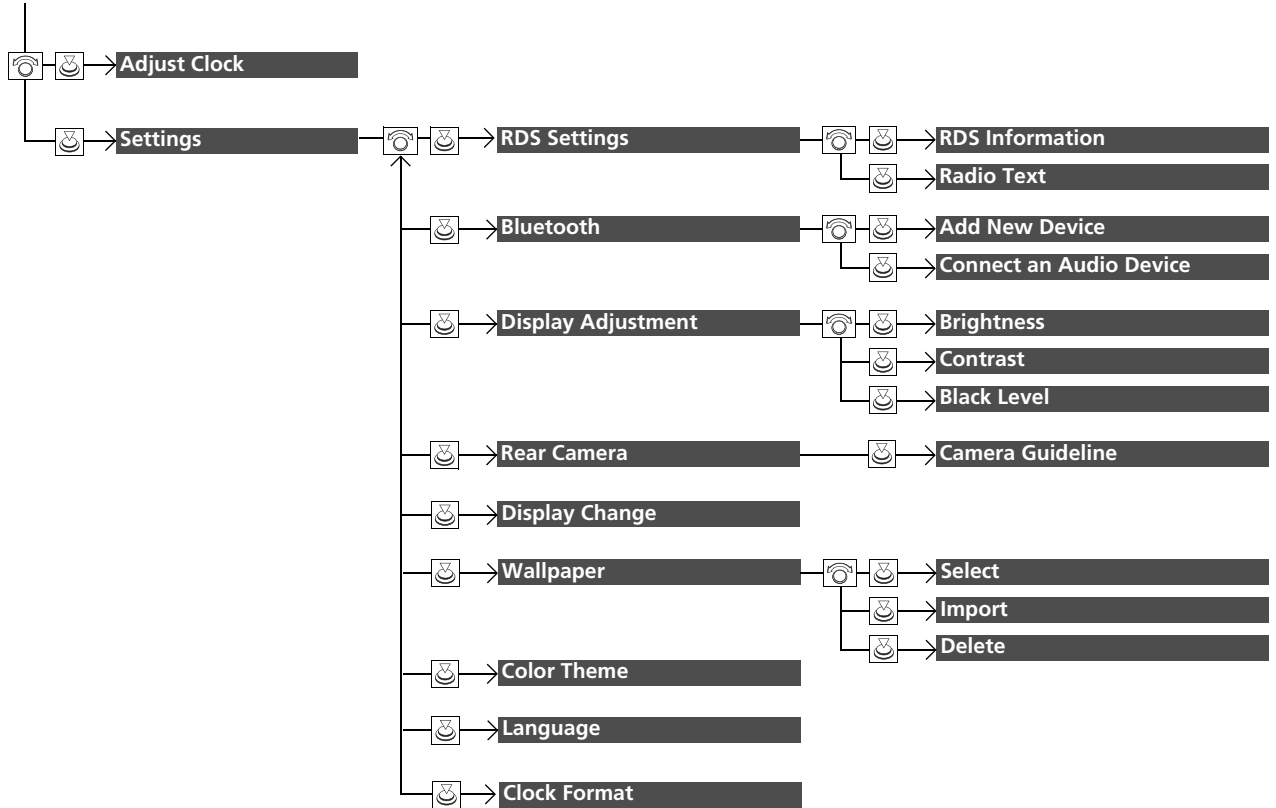

Press the  button and rotate  to select **Phone Setup**, then press .

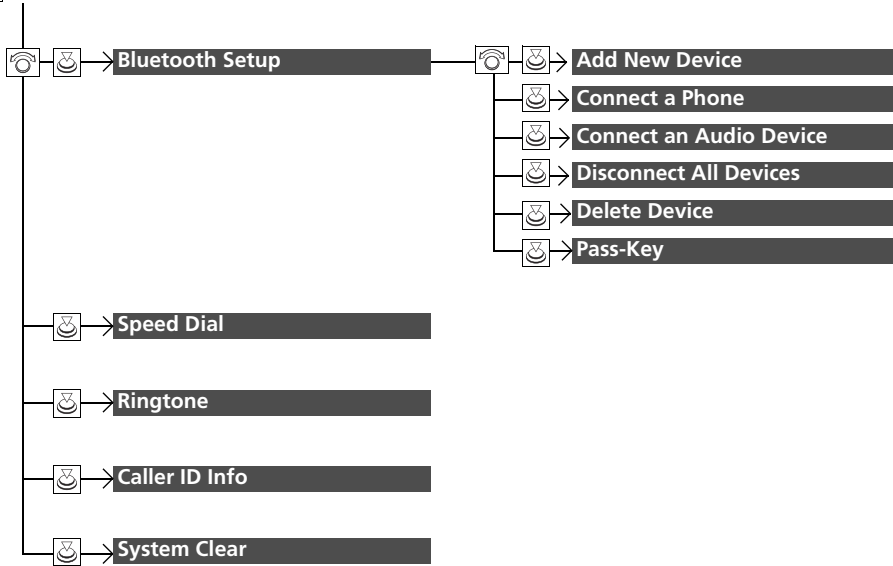

■ List of customizable options

Setup Group	Customizable Features	Description	Selectable Settings	
Settings	Adjust Clock	Adjusts clock.  Clock P. 110	—	
	RDS Settings	RDS Information	Selects whether the RDS information comes on.	On *1/ Off
		Radio Text	Displays the radio text information of the selected RDS station.	—
	Bluetooth	Add New Device		
		Connect an Audio Device	See Bluetooth Setup on P. 322	
	Display Adjustment	Brightness	Changes the brightness of the audio/information screen.	—
		Contrast	Changes the contrast of the audio/information screen.	—
		Black Level	Changes the black level of the audio/information screen.	—
	Rear Camera	Camera Guideline	Selects whether the guidelines come on the audio/information screen.	On *1/ Off

*1:Default Setting

Setup Group	Customizable Features	Description	Selectable Settings
Settings	Display Change	Changes the display type.	Audio^{*1}/Wallpaper
	Wallpaper		Clock^{*1}/Image1/Image2/ Image3
	Select	Changes the wallpaper type.	
	Import	Imports an image file for a new wallpaper.  Wallpaper Setup P. 209	—
	Delete	Deletes an image file for a wallpaper.	Image1^{*1}/Image2/Image3
	Color Theme	Changes the background color of the audio/ information screen.	Blue^{*1}/Red/Amber/Gray
	Language	Changes the display language.	English^{*1}/French/Spanish
	Clock Format	Selects the digital clock display from 12h to 24h.	12h^{*1}/24h

*1:Default Setting

Setup Group	Customizable Features	Description	Selectable Settings
Phone Setup	Add New Device	Pairs a new phone to HFL. ➤ Phone Setup P. 357	—
	Connect a Phone	Pairs a new phone or connects a paired phone to HFL. ➤ Phone Setup P. 357	—
	Bluetooth Setup		
	Connect an Audio Device	Connects a <i>Bluetooth</i> ® Audio device to HFL.	—
	Disconnect All Devices	Disconnects a paired phone from HFL.	—
	Delete Device	Deletes a paired phone.	—
	Pass-Key	Changes a pairing code.	—
	Speed Dial	Edits, adds or deletes a speed dial entry. ➤ Speed Dial P. 366	—
	Ringtone	Selects the ring tone.	Mobile Phone *1/ Fixed
	Caller ID Info	Prioritizes the caller's name or phone number as the caller ID.	Name Priority *1/ Number Priority
System Clear	Cancels/Resets all customized items in the Phone Setup group as default.	—	

*1:Default Setting

Models with Display Audio

■ How to customize

With the power mode in ON, select **Settings**, then select a setting item.

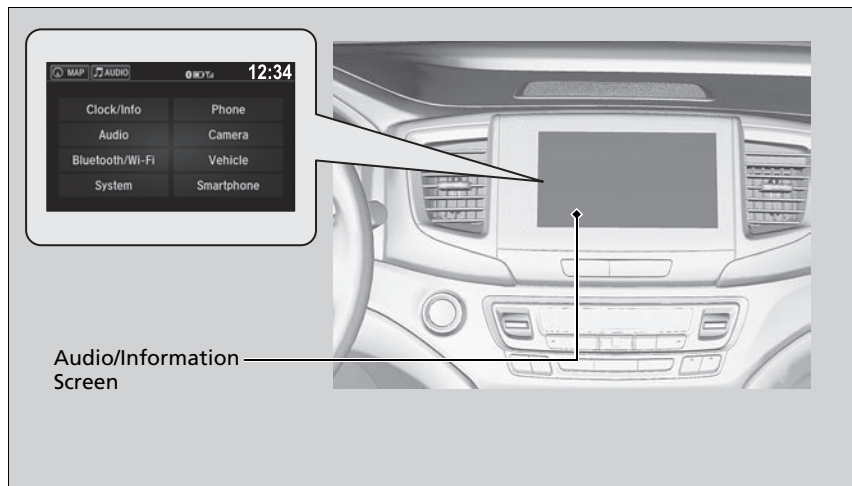

▶ Customized Features

When you customize settings, make sure that the vehicle is at a complete stop and shift to **P**.

To customize other features, select **Settings**.

➤ **List of customizable options** P. 332

■ Customization flow

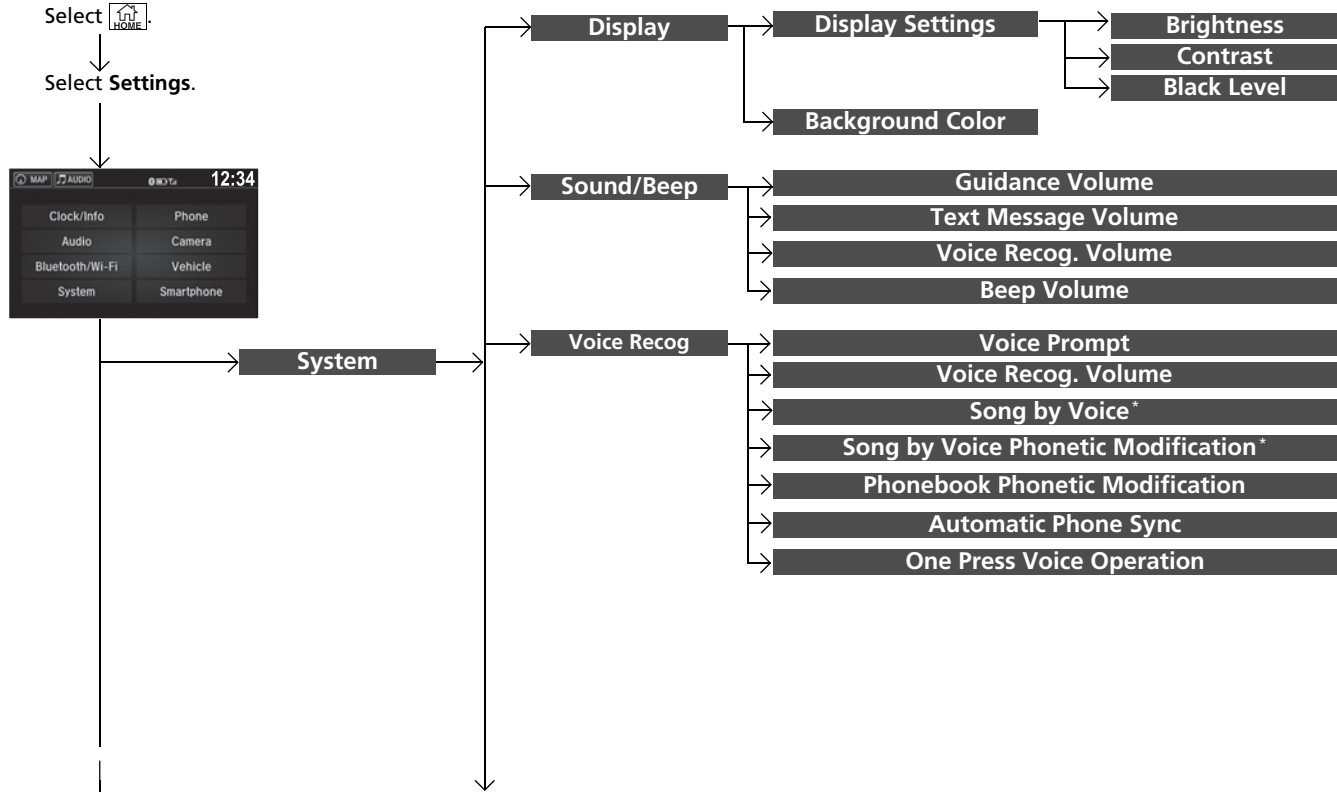

Features

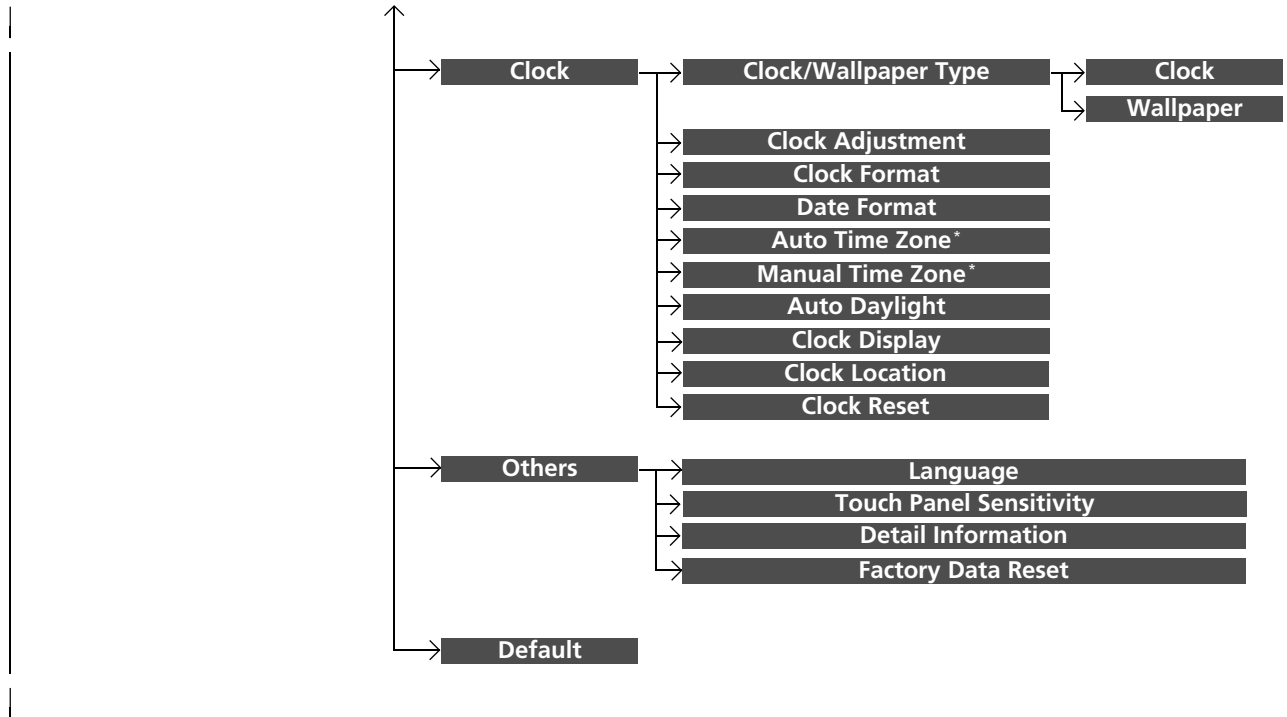

* Not available on all models

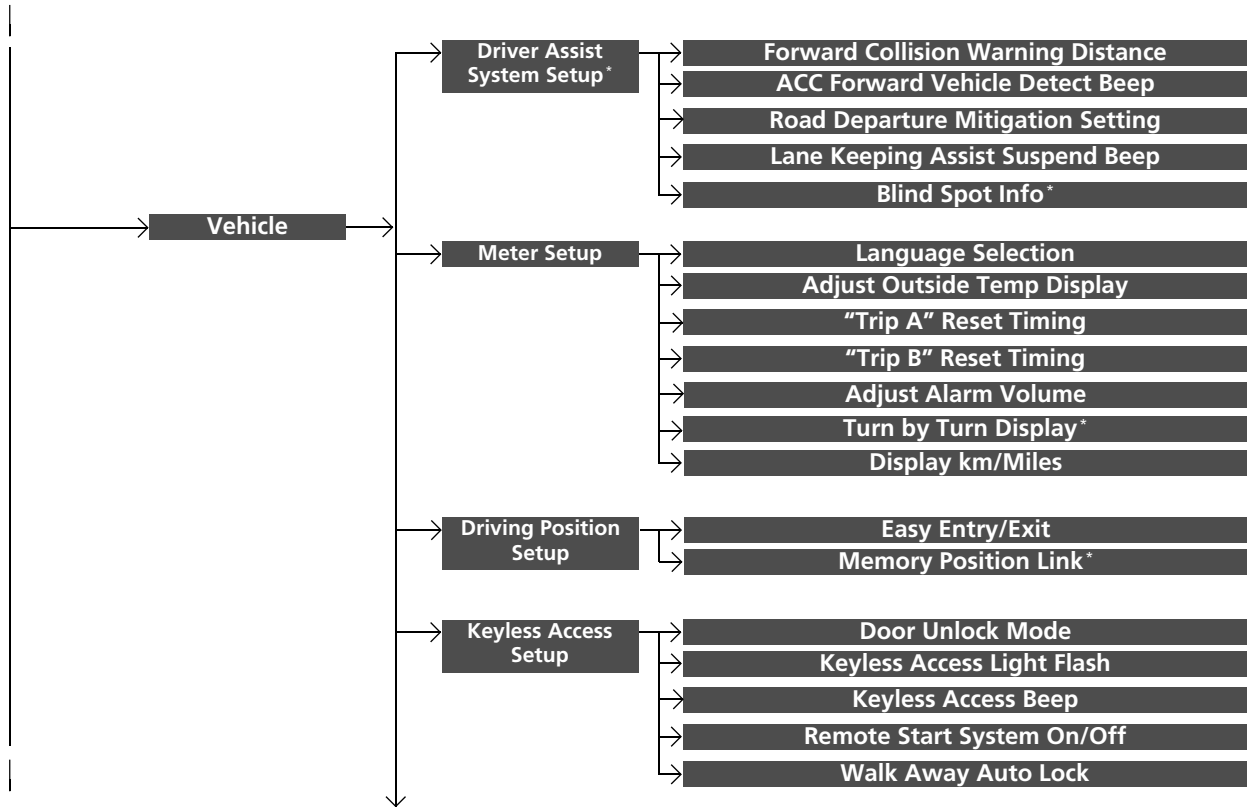

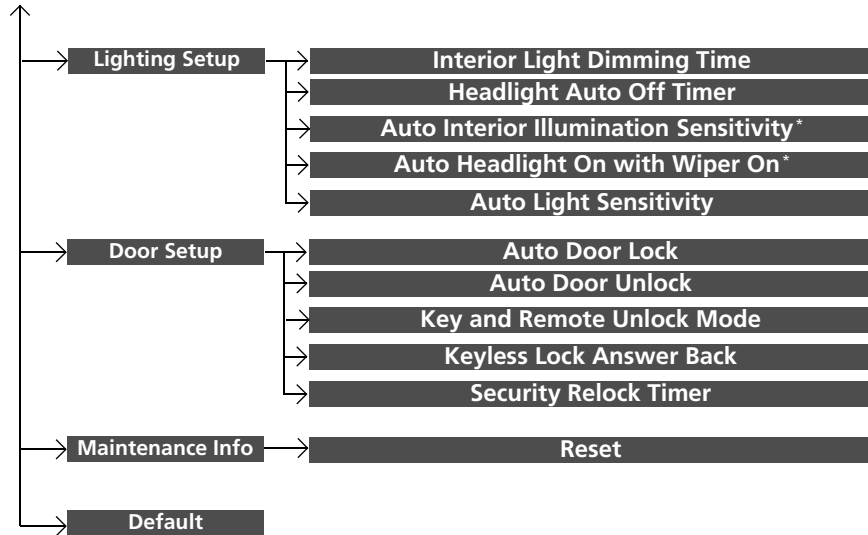

* Not available on all models

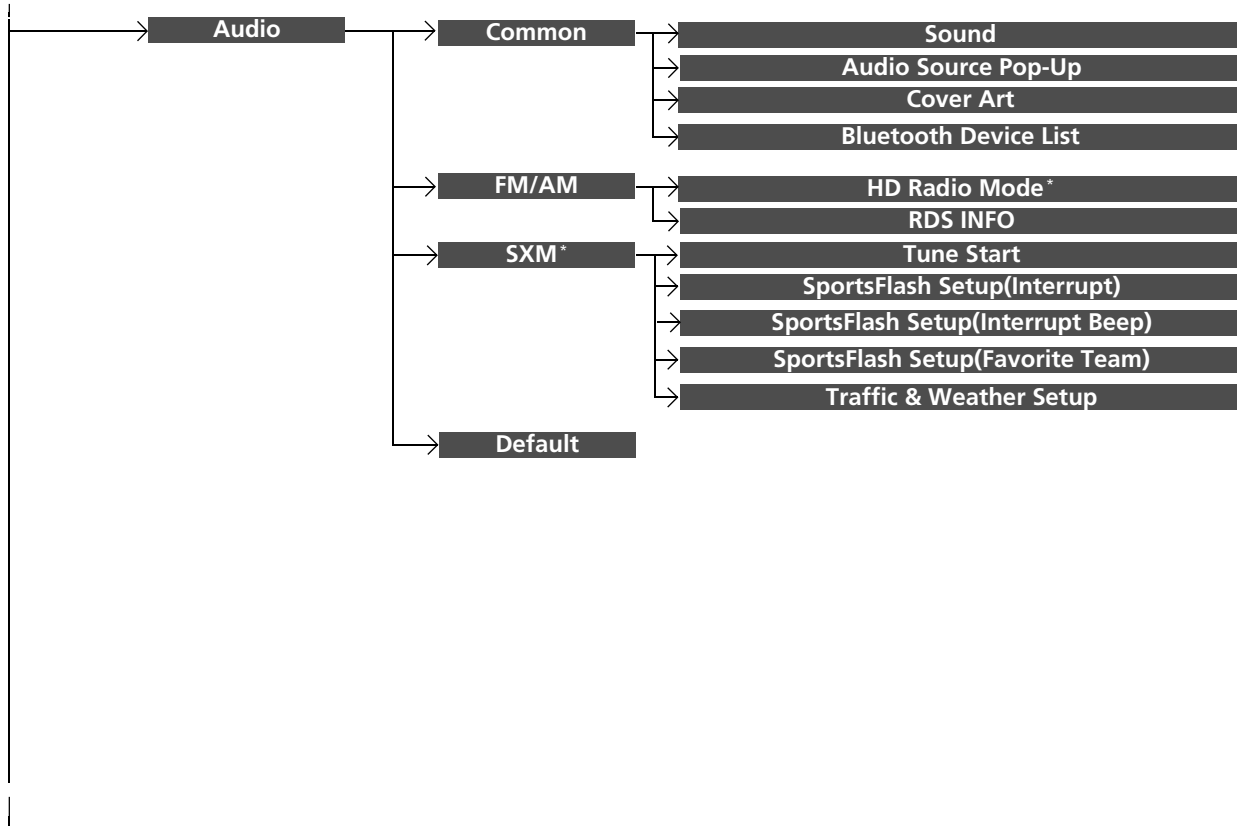

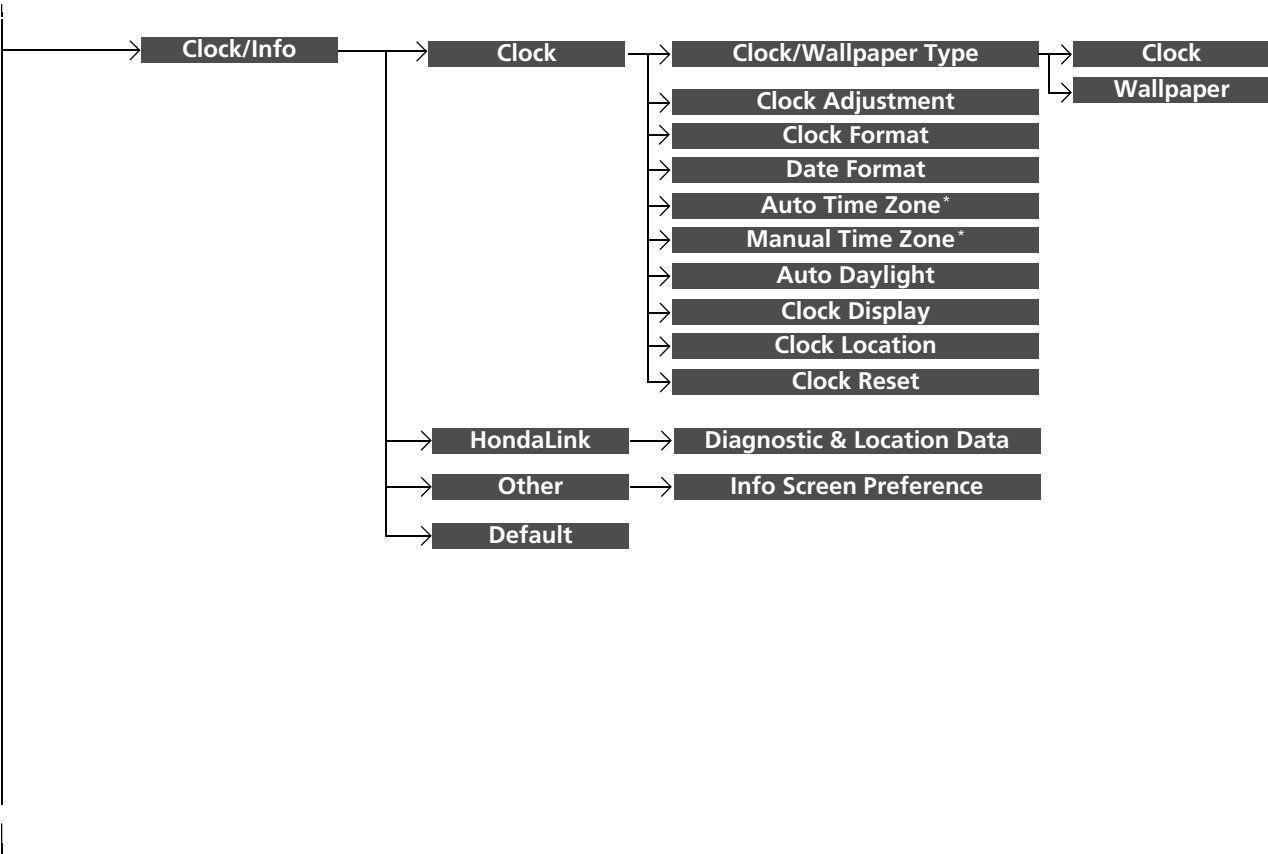

* Not available on all models

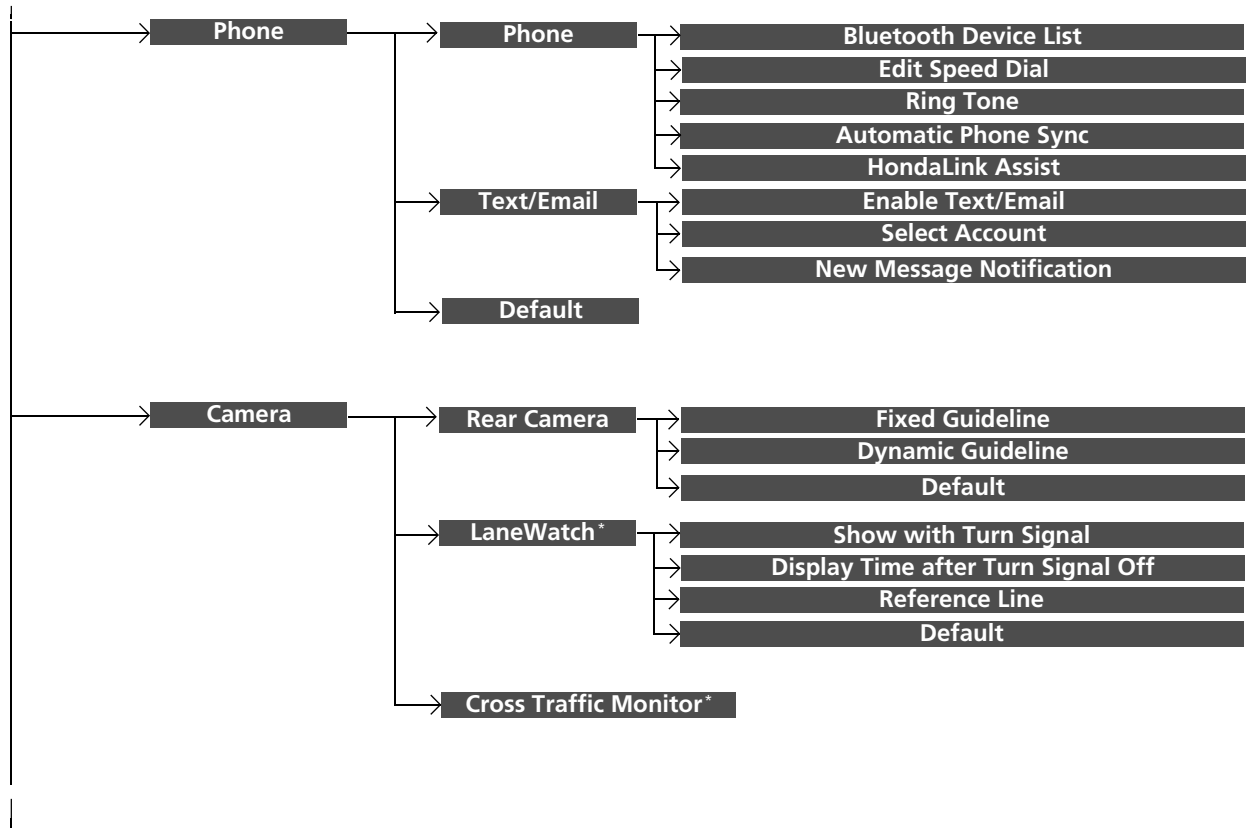

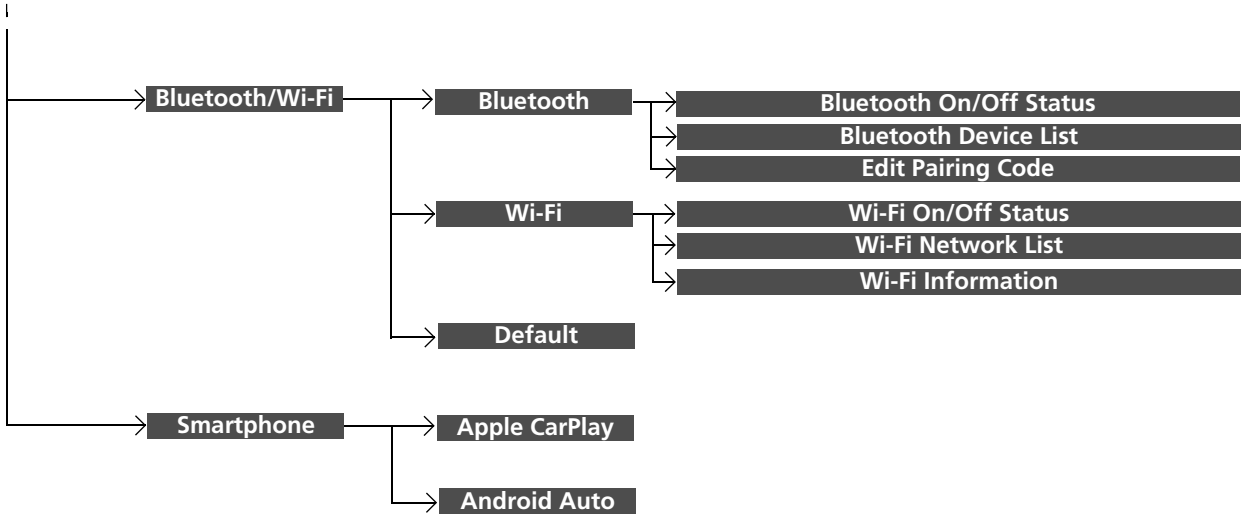

■ List of customizable options

Setup Group	Customizable Features	Description	Selectable Settings	
System	Display Settings	Brightness	Changes the brightness of the audio/information screen.	—
		Contrast	Changes the contrast of the audio/information screen.	—
		Black Level	Changes the black level of the audio/information screen.	—
	Background Color	Changes the background color of the audio/information screen.	Blue^{*1}/Amber/Red/Violet	
	Sound/Beep	Guidance Volume	Changes the sound volume. Adjusts the guidance volume of the navigation system.	1~6^{*1}~11
		Text Message Volume	Changes the text/e-mail message reading volume.	1~6^{*1}~11
		Voice Recog. Volume	Changes the volume of the voice prompt.	1~6^{*1}~11
Beep Volume		Changes the beep volume.	Off^{*1}/1/2/3	

*1: Default Setting

Setup Group	Customizable Features	Description	Selectable Settings	
System	Voice Recog	Voice Prompt	Turns the voice prompt on and off.	On ^{*1} /Off
		Voice Recog. Volume	Changes the volume of the voice prompt.	1~6 ^{*1} ~11
		Song by Voice[*]	Turns the Song By Voice™ on and off.	On ^{*1} /Off
		Song by Voice Phonetic Modification[*]	Modifies a voice command for music stored in the system or an iPod/iPhone. ▶ Phonetic Modification P. 269	—
		Phonebook Phonetic Modification	Modifies a voice command for the phonebook. ▶ Phonebook Phonetic Modification P. 393	—
		Automatic Phone Sync	Sets phonebook and call history data to be automatically imported when a phone is paired to HFL.	On ^{*1} /Off
		One Press Voice Operation	Changes the setting of the touch screen operation when using the voice operation.	On/Off ^{*1}

*1:Default Setting

Setup Group	Customizable Features	Description	Selectable Settings
System	Clock/ Wallpaper Type	Clock	Changes the clock display type. Analog/Digital^{*1}/Small Digital/Off
		Wallpaper	<ul style="list-style-type: none"> Changes the wallpaper type. Imports an image file for a new wallpaper. Deletes an image file for a wallpaper. Time Zone/Galaxy^{*1}/Metallic/Blank
		Clock Adjustment	Adjusts clock. —
		Clock Format	Selects the digital clock display from 12H to 24H. 12H^{*1}/24H
	Clock	Date Format	Sets the date format. YYYY/MM/DD/ MM/DD/YYYY^{*1}/ DD/MM/YYYY
		Auto Time Zone[*]	Sets the navigation system to automatically adjust the clock when driving through different time zones. On^{*1}/Off
		Manual Time Zone[*]	Changes the time zone manually. —
		Auto Daylight	Select On to have the GPS automatically adjust the clock to daylight savings time. Select Off to cancel this function. On^{*1}/Off

*1: Default Setting

Setup Group	Customizable Features	Description	Selectable Settings	
System	Clock Display	Selects whether the clock display comes on.	On^{*1}/Off	
	Clock	Clock Location	Changes the clock display layout.	Upper Right^{*1}/Upper Left/Lower Right/Lower Left/Off
		Clock Reset	Resets the clock settings to the factory default.	Yes/No
		Language	Changes the display language.	English^{*1}/French/Spanish
	Others	Touch Panel Sensitivity	Sets the sensitivity of the touch panel screen.	High/Low^{*1}
		Detail Information	Displays the Android setting items.	—
		Factory Data Reset	Resets all the settings to their factory default.  Defaulting All the Settings P. 347	Yes/No
	Default	Cancels/Resets all customized items in the System settings group as default.		Yes/No

*1:Default Setting

Setup Group	Customizable Features	Description	Selectable Settings
Vehicle	Driver Assist System Setup*		
	Forward Collision Warning Distance	Changes at which distance CMBS™ alerts.	Long/Normal*¹/Short
	ACC Forward Vehicle Detect Beep	Causes the system to beep when the system detects a vehicle, or when the vehicle goes out of the ACC range.	On/Off*¹
	Road Departure Mitigation Setting	Changes the setting for the road departure mitigation system.	Normal*¹/Wide/Warning Only
	Lane Keeping Assist Suspend Beep	Causes the system to beep when the LKAS is suspended.	On/Off*¹
	Blind Spot Info*	Changes the setting for the blind spot information.	Audible and Visual Alert*¹/Visual Alert/Off

*1:Default Setting

Setup Group	Customizable Features	Description	Selectable Settings	
Vehicle	Meter Setup	Language Selection	Changes the displayed language on the multi-information display.	English^{*1}/French/ Spanish
		Adjust Outside Temp Display	Adjusts the temperature reading by a few degrees.	-5°F ~ ±0°F^{*1} ~ +5°F (U.S.) -3°C ~ ±0°C^{*1} ~ +3°C (Canada)
		"Trip A" Reset Timing	Changes the setting of how to reset trip meter A and average fuel economy A.	With Refuel/IGN Off/ Manually Reset^{*1}
		"Trip B" Reset Timing	Changes the setting of how to reset trip meter B and average fuel economy B.	With Refuel/IGN Off/ Manually Reset^{*1}
		Adjust Alarm Volume	Changes the alarm volume, such as the buzzers, warnings, turn signal sound, and so on.	High/Mid^{*1}/Low
		Turn by Turn Display[*]	Selects whether the turn-by-turn display comes on during the route guidance.	On^{*1}/Off
		Display km/Miles	Selects the trip computer units.	Auto/km/Miles^{*1} (U.S.) Auto/km^{*1}/Miles (Canada)

*1:Default Setting

* Not available on all models

Setup Group	Customizable Features	Description	Selectable Settings	
Vehicle	Driving Position Setup	Easy Entry/Exit	Moves the seat rearward when you get in/get out of the vehicle. Changes the setting for this feature.	On^{*1}/Off
		Memory Position Link[*]	Turns the driving position memory system on and off.	On^{*1}/Off
		Door Unlock Mode	Changes which doors unlock when you grab the driver's door handle.	Driver Door Only^{*1}/ All Doors
		Keyless Access Light Flash	Causes some exterior lights to flash when you unlock/lock the doors.	On^{*1}/Off
	Keyless Access Setup	Keyless Access Beep	Causes the beeper to sound when you unlock/lock the doors.	On^{*1}/Off
		Remote Start System On/Off	Turns the remote engine start feature on and off.	On^{*1}/Off
	Walk Away Auto Lock	Changes the settings for the automatic locking the doors when you walk away from the vehicle while carrying the smart entry remote.	Enable/Disable^{*1}	

*1:Default Setting

Setup Group	Customizable Features	Description	Selectable Settings	
Vehicle	Lighting Setup	Interior Light Dimming Time	Changes the length of time the interior lights stay on after you close the doors.	60 sec/30 sec^{*1}/15 sec
		Headlight Auto Off Timer	Changes the length of time the exterior lights stay on after you close the driver's door.	60 sec/30 sec/15 sec^{*1}/0 sec
		Auto Interior Illumination Sensitivity*	Changes the sensitivity of the brightness of the instrument panel when the headlight switch is in the AUTO position.	Min/Low/Mid^{*1}/High/Max
		Auto Headlight On with Wiper On*	Changes the settings for the wiper operation when the headlights automatically come on while the headlight switch is in the AUTO position.	Off/On^{*1}
		Auto Light Sensitivity	Changes the timing for the headlights to come on.	Max/High/Mid^{*1}/Low/Min

*1:Default Setting

Setup Group	Customizable Features	Description	Selectable Settings	
Vehicle	Door Setup	Auto Door Lock	Changes the setting for the automatic locking feature.	With Vehicle Speed*¹/Shift from P/ Off
		Auto Door Unlock	Changes the setting for when the doors unlock automatically.	All Doors with Driver's Door Opens*¹/All Doors with Shift to P/All Doors with IGN Off/ Off
		Key and Remote Unlock Mode	Sets up either the driver's door or all doors to unlock on the first push of the remote or built-in key.	Driver Door*¹/All Doors
		Keyless Lock Answer Back	LOCK/UNLOCK- The exterior lights flash. LOCK (2nd push)- The beeper sounds.	On*¹/Off
		Security Relock Timer	Changes the time it takes for the doors to relock and the security system to set after you unlock the vehicle without opening any door.	90 sec/60 sec/30 sec*¹
Maintenance Info.	Maintenance Reset	Resets the engine oil life display when you have performed the maintenance service.	—	
Default		Cancels/Resets all customized items in the Vehicle group as default.	Yes/No	

*1: Default Setting

Setup Group	Customizable Features	Description	Selectable Settings
Audio	Sound	Adjusts the settings of the audio speakers' sound. ▶ Adjusting the Sound P. 242	-6 ~ 0*1 ~ +6 (BASS and TREBLE), RR9~0*1 ~FR9 (FADER), L9~ 0*1~R9 (BALANCE), -6 ~ 0*1 ~ +6 (Center and Subwoofer), Off/Low/Mid*1/High (Speed Volume Compensation)
	Common	Audio Source Pop-Up	Selects whether the list of selectable audio source comes on when Audio is selected on the home screen. On/Off*1
	iPod or USB mode [Your selected media]	Cover Art	Turns the cover art display on and off. On*1/Off
		Bluetooth Device List	Pairs a new phone to HFL, edits or deletes a paired phone. ▶ Phone Setup P. 384 —
	FM/AM mode FM/AM	HD Radio Mode*	Selects whether the audio system automatically switches to the digital radio waves or receives the analog waves only. Auto*1/Analog
	RDS INFO	Turns on and off the RDS information. On*1/Off	

*1:Default Setting

* Not available on all models

Setup Group	Customizable Features	Description	Selectable Settings
Audio	Tune Start	Turns on and off, starts the song from the beginning as you change preset stations.	On^{*1}/Off
	SportsFlash Setup (Interrupt)	Turns on and off the sports alert function.	Off^{*1}/On (one time)/ On (continue)
	SiriusXM[®] mode SXM[*] SportsFlash Setup (Interrupt Beep)	Causes the system to beep when there is a sports alert notification.	On/Off^{*1}
	SportsFlash Setup (Favorite Team)	Selects your favorite sports teams. ▶ Live Sports Alert P. 258	—
	Traffic & Weather Setup	Selects the region you want to receive the information.	—
Default		Cancels/Resets all customized items in the Audio settings group as default.	Yes/No

*1:Default Setting

Setup Group	Customizable Features	Description	Selectable Settings	
Clock/ Info	Clock/Wallpaper Type	Clock Wallpaper		
	Clock Adjustment			
	Clock Format			
	Date Format			
	Clock	Auto Time Zone*	See System on P. 334, 335	
		Manual Time Zone*		
		Auto Daylight		
		Clock Display		
		Clock Location		
		Clock Reset		
HondaLink	Diagnostic & Location Data	Turns HondaLink® on and off.	On/Off*1	
Other	Info Screen Preference	Changes the information screen type.	Info Top/Info Menu*1/Off	
Default		Cancels/Resets all customized items in the Clock/Info settings group as default.	Yes/No	

*1:Default Setting

* Not available on all models

Setup Group	Customizable Features	Description	Selectable Settings	
Phone	Bluetooth Device List	Pairs a new phone to HFL, connects or disconnects a paired phone. ➤ Phone Setup P. 384	—	
	Edit Speed Dial	Edits, adds or deletes a speed dial entry. ➤ Speed Dial P. 390	—	
	Ring Tone	Selects the ring tone.	Fixed/Mobile Phone *1	
	Automatic Phone Sync	Sets phonebook and call history data to be automatically imported when a phone is paired to HFL.	On *1/ Off	
	HondaLink Assist	Turns HondaLink® Assist on and off.	On *1/ Off	
	Text/Email	Enable Text/Email	Turns the text/e-mail message function on and off.	On/Off *1
		Select Account	Selects a text or e-mail message account.	—
		New Message Notification	Selects whether a pop-up alert comes on the screen when HFL receives a new text/e-mail messages.	On/Off
Default	Cancels/Resets all customized items in the Phone settings group as default.	Yes/No		

*1:Default Setting

Setup Group	Customizable Features	Description	Selectable Settings
Camera	Rear Camera	Fixed Guideline Selects whether the fixed guidelines come on the rear camera monitor. ▶ Multi-View Rear Camera P. 510	On^{*1}/Off
		Dynamic Guideline Selects whether the dynamic guidelines come on the rear camera monitor. ▶ Multi-View Rear Camera P. 510	On^{*1}/Off
		Default Cancels/Resets all customized items in the Rear Camera setting group as default.	Yes/No
	LaneWatch*	Show with Turn Signal Selects whether the LaneWatch display comes on when you move the turn signal lever to indicate a right turn.	On^{*1}/Off
		Display Time after Turn Signal Off Changes the length of time the LaneWatch display stays on after the turn signal lever returns to the center.	0 second^{*1}/2 seconds
		Reference Line Selects whether the reference lines come on the LaneWatch monitor.	On^{*1}/Off
		Default Cancels/Resets all customized items in the LaneWatch group as default.	Yes/No
	Cross Traffic Monitor*	Turns on and off the cross traffic monitor.	On^{*1}/Off

*1:Default Setting

* Not available on all models

Setup Group	Customizable Features	Description	Selectable Settings	
Bluetooth/ Wi-Fi	Bluetooth On/Off Status	Selects to display the <i>Bluetooth</i> ® status.	On*¹/Off	
	Bluetooth Device List	Pairs a new phone to HFL, edits or deletes a paired phone, or creates a security PIN. ☒ Phone Setup P. 384	—	
	Edit Pairing Code	Edits a pairing code. ☒ To change the pairing code setting P. 385	Random/Fixed*¹	
	Wi-Fi	Wi-Fi On/Off Status	Changes the Wi-Fi mode.	On/Off*¹
		Wi-Fi Network List	Connects, disconnects, or deletes the Wi-Fi network.	—
		Wi-Fi Information	Shows the Wi-Fi information of the head unit.	—
	Default	Cancels/Resets all customized items in the Bluetooth/Wi-Fi group as default.	Yes/No	
Smart phone	Apple CarPlay	Sets up the Apple CarPlay connection.	—	
	Android Auto	Sets up the Android Auto connection.	—	

*1:Default Setting

Models with Display Audio

Defaulting All the Settings

Reset all the menu and customized settings as the factory defaults.

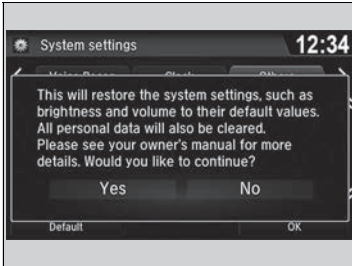

1. Select .
2. Select **Settings**.
3. Select **System**.
4. Select the **Others** tab.
5. Select **Factory Data Reset**.
 - ▶ A confirmation message appears on the screen.
6. Select **Yes** to reset the settings.
7. Select **Yes** again to reset the settings.
 - ▶ A confirmation message appears on the screen. Select **OK**.
 - ▶ After selecting **OK**, the system will reboot.

Defaulting All the Settings

When you transfer the vehicle to a third party, reset all settings to default and delete all personal data.

If you perform **Factory Data Reset**, it will reset the preinstalled apps to their factory default.

If you perform **Factory Data Reset**, you cannot use the HondaLink® because it becomes off line.

 **HondaLink®** P. 278

The HomeLink® Universal Transceiver can be programmed to operate up to three remote controlled devices around your home, such as garage doors, lighting, or home security systems.

■ Important Safety Precautions

Refer to the safety information that came with your garage door opener to test that the safety features are functioning properly. If you do not have the safety information, contact the manufacturer.

Before programming HomeLink, make sure that people and objects are out of the way of the garage or gate to prevent potential injury or damage.

When programming a garage door opener, park just outside the garage door's path.

⌘ HomeLink® Universal Transceiver*

Before programming HomeLink to operate a garage door opener, confirm that the opener has an external entrapment protection system, such as an "electronic eye," or other safety and reverse stop features. If it does not, HomeLink may not be able to operate it.

Training HomeLink

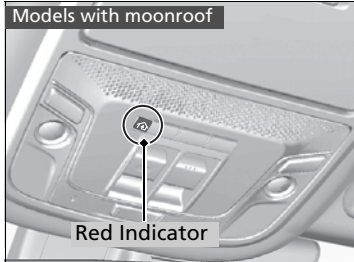
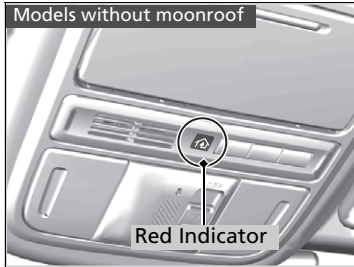

If it is necessary to erase a previously entered learned code:

- Press and hold the two outside buttons for about 20 seconds, until the red indicator blinks. Release the buttons, and proceed to step 1.
- If you are training the second or third button, go directly to step 1.

The instructions on the next page should work for most gate or garage openers, but may not work for all. For detailed instructions about your specific remote opener, visit <http://www.homelink.com> or call (800) 355-3515.

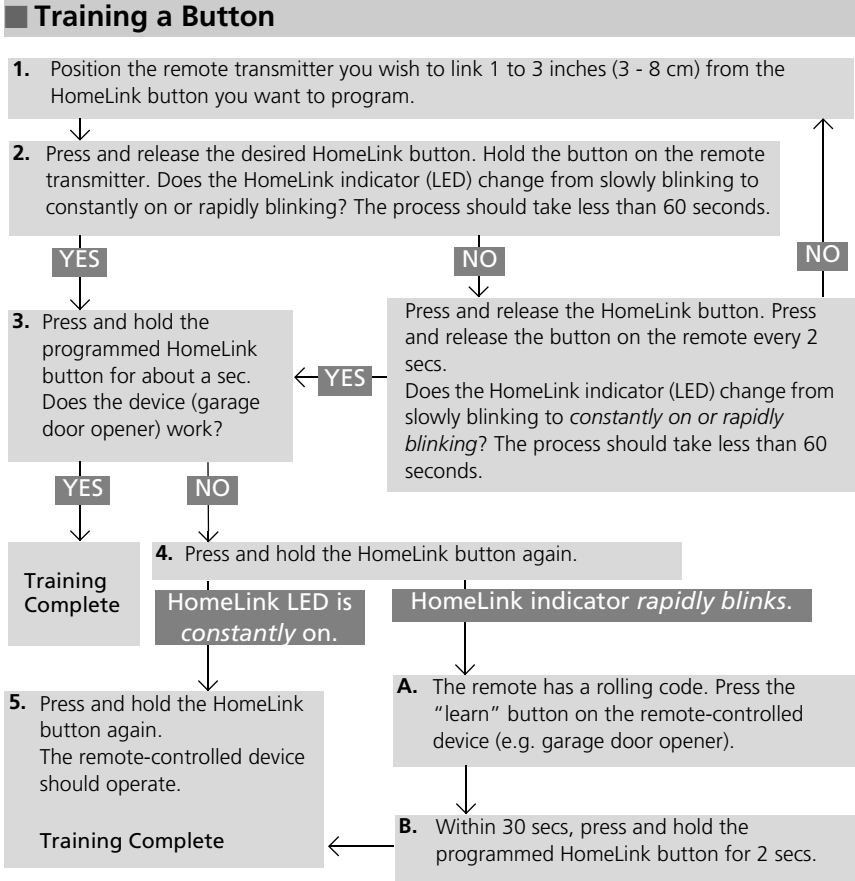

▶▶ Training HomeLink

Retraining a Button

If you want to retrain a programmed button for a new device, you do not have to erase all button memory. You can replace the existing memory code using this procedure:

- Press and hold the desired HomeLink button until the HomeLink indicator begins to blink.
 - Standard transmitter**
Indicator remains on for about 25 secs.
 - Rolling code transmitter**
Indicator remains on for about 25 secs.
- Quickly release the HomeLink button and follow steps 1 - 3 under "Training a Button." You do not need to press and release the HomeLink button again in step 2.

Erasing Codes

To erase all the codes, press and hold the two outside buttons until the HomeLink indicator begins to blink (about 10 to 20 secs). You should erase all codes before selling the vehicle.

If you have any problems, see the device's instructions, visit www.homelink.com, or call HomeLink at (800) 355-3515.

HomeLink® is a registered trademark of Gentex Corporation.

Models with color audio system

Bluetooth® HandsFreeLink® (HFL) allows you to place and receive phone calls using your vehicle's audio system, without handling your cell phone.

Using HFL

HFL Buttons

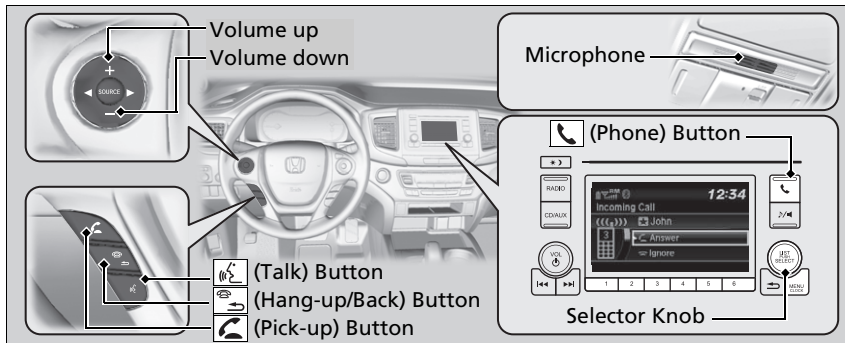

(Pick-up) button: Press to go directly to the Phone screen or to answer an incoming call.

(Hang-up/Back) button: Press to end a call or to cancel a command.

(Talk) button: Press to call a number with a stored voice tag.

(Phone) button: Press to go directly to the Phone screen.

Selector knob: Rotate to select an item on the screen, then press .

Using HFL

Place your phone where you can get good reception.

To use HFL, you need a Bluetooth-compatible cell phone. For a list of compatible phones, pairing procedures, and special feature capabilities:

- U.S.: Visit automobiles.honda.com/handsfreelink/, or call 1-888-528-7876.
- Canada: Visit www.handsfreelink.ca, or call 1-888-528-7876.

Voice control tips

- Aim the vents away from the ceiling and close the windows, as noise coming from them may interfere with the microphone.
- Press and release the button when you want to call a number using a stored voice tag. Speak clearly and naturally after a beep.
- If the microphone picks up voices other than yours, the command may be misinterpreted.
- To change the volume level, use the audio system's volume knob or the remote audio controls on the steering wheel.

State or local laws may prohibit the operation of handheld electronic devices while operating a vehicle.

HFL Status Display

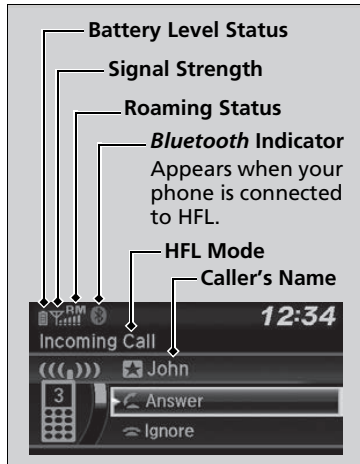

The audio/information screen notifies you when there is an incoming call.

Limitations for Manual Operation

Certain manual functions are disabled or inoperable while the vehicle is in motion. You cannot select a grayed-out option until the vehicle is stopped.

Only previously stored speed dial entries can be called using voice commands while the vehicle is in motion.

▶ **Speed Dial** P. 366

Using HFL

If you receive a call while using the audio system, the system resumes its operation after ending the call.

Up to 20 speed dial entries can be stored. If there is no entry in the system, Speed Dial is disabled.

▶ **Speed Dial** P. 366

Up to 20 call histories can be stored. If there is no call history, Call History is disabled.

Bluetooth® Wireless Technology

The *Bluetooth*® word mark and logos are registered trademarks owned by *Bluetooth* SIG, Inc., and any use of such marks by Honda Motor Co., Ltd., is under license. Other trademarks and trade names are those of their respective owners.

HFL Limitations

An incoming call on HFL will interrupt the audio system when it is playing. It will resume when the call is ended.

HFL Status Display

The information that appears on the audio/information screen varies between phone models.

You can change the system language.

▶ **Customized Features** P. 317

HFL Menus

The power mode must be in ACCESSORY or ON to use the system.

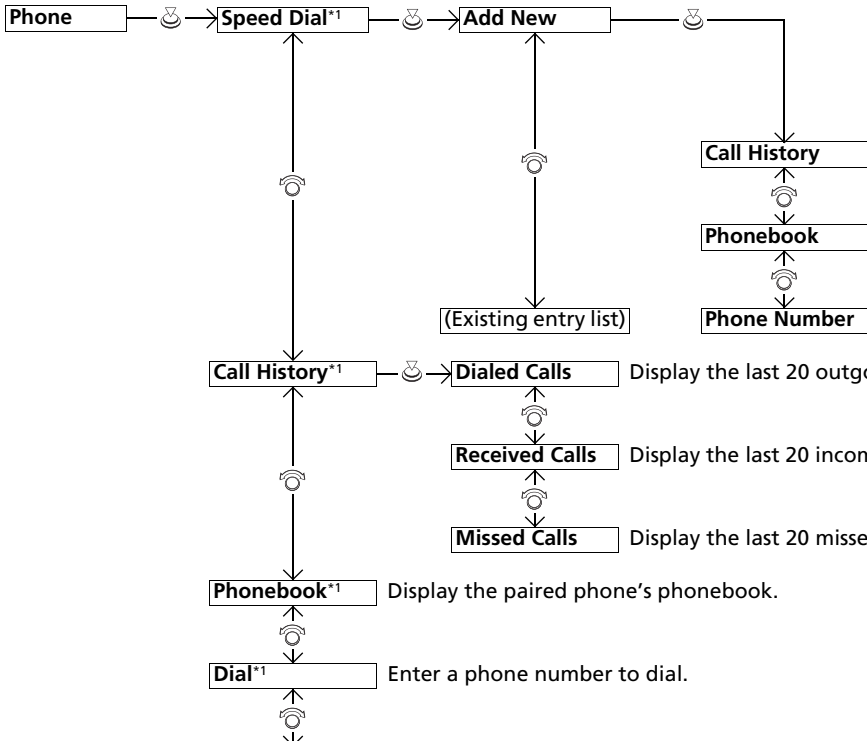
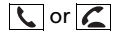

HFL Menu

To use HFL, you must first pair your *Bluetooth*-compatible cell phone to the system while the vehicle is parked.

Some functions are limited while driving.

Select a phone number from the call history to store as a speed dial number.

Select a phone number from the phonebook to store as a speed dial number.

Enter a phone number to store as a speed dial number.

Display the last 20 outgoing calls.

Display the last 20 incoming calls.

Display the last 20 missed calls.

Display the paired phone's phonebook.

Enter a phone number to dial.

*1: Appears only when a phone is connected to HFL.

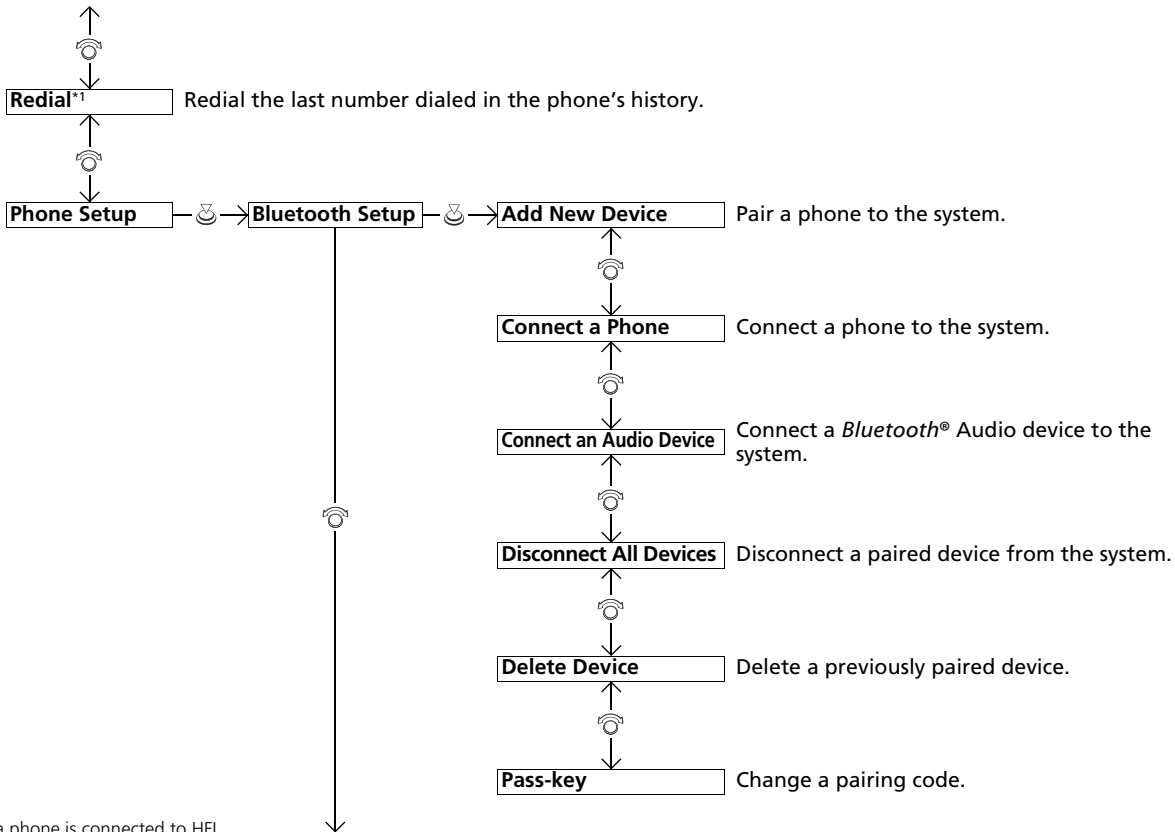

*1: Appears only when a phone is connected to HFL.

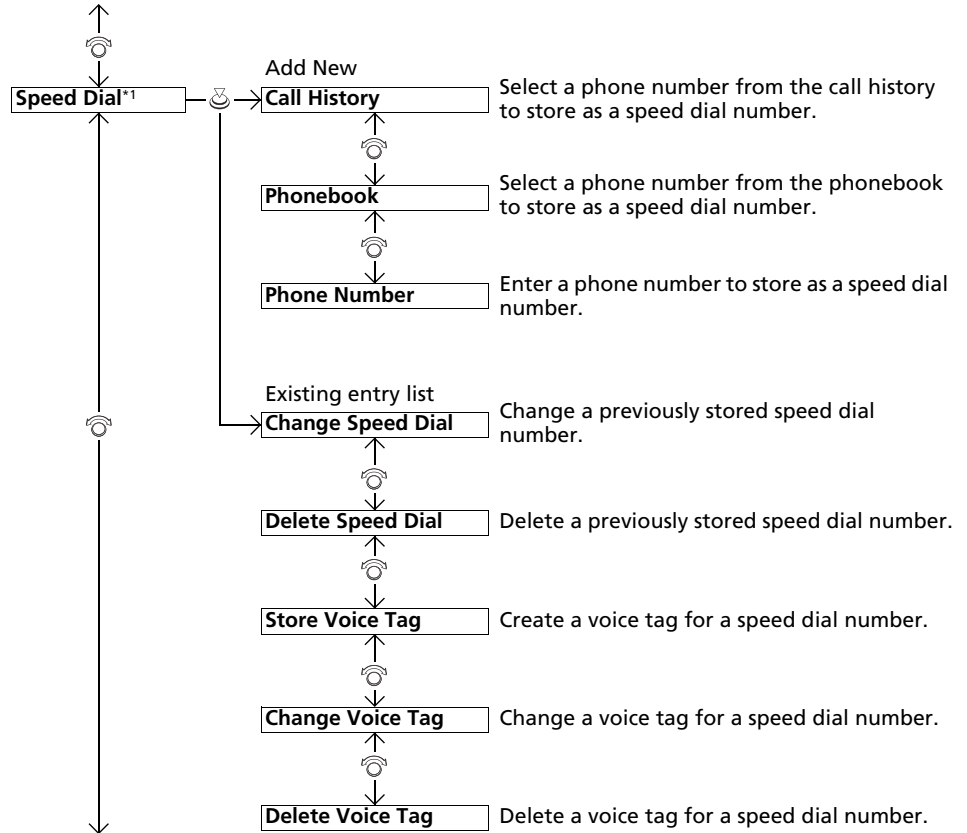

*1: Appears only when a phone is connected to HFL.

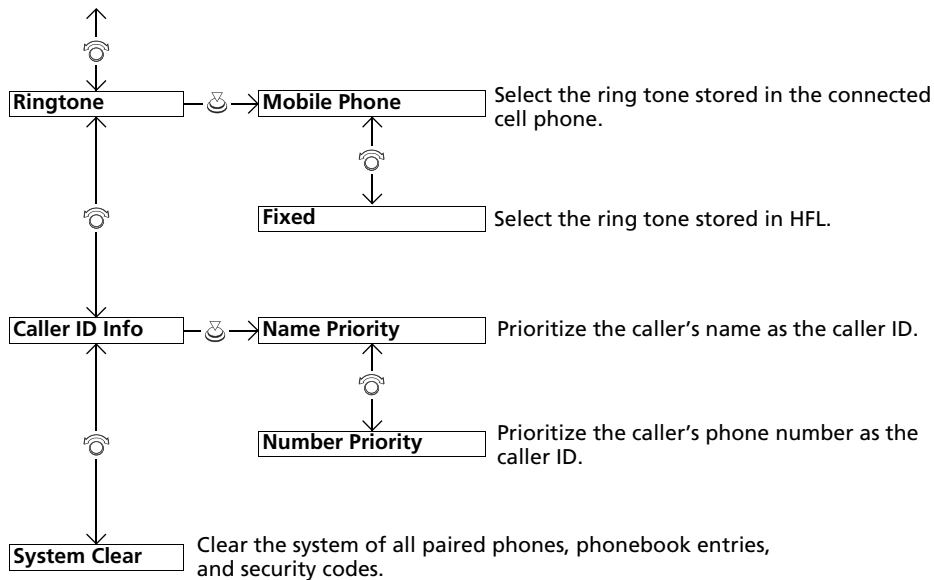

Phone Setup

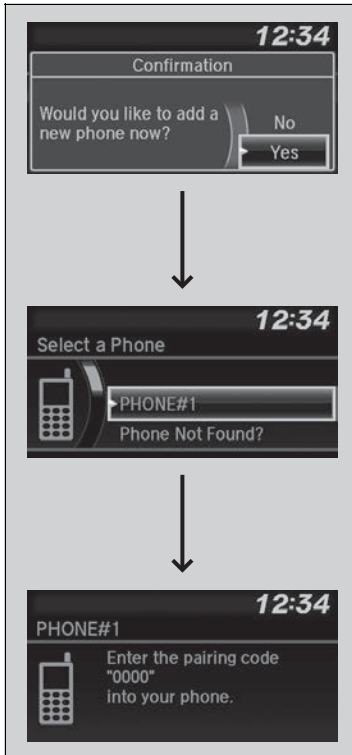

■ To pair a cell phone (when there is no phone paired to the system)

1. Press the button or the button.
2. Rotate to select **Yes**, then press .
3. Make sure your phone is in search or discoverable mode, then press .
 - ▶ HFL automatically searches for a *Bluetooth*® device.
4. When your phone appears on the list, select it by pressing .
 - ▶ If your phone does not appear, select **Phone Not Found?** and search for *Bluetooth*® devices using your phone. From your phone, select **HandsFreeLink**.
5. The system gives you a pairing code on the audio/information screen.
 - ▶ Confirm if the pairing code on the screen and your phone match. This may vary by phone.
6. A notification appears on the screen if pairing is successful.

☒ Phone Setup

Your *Bluetooth*-compatible phone must be paired to HFL before you can make and receive hands-free calls.

Phone Pairing Tips:

- You cannot pair your phone while the vehicle is moving.
- Up to six phones can be paired.
- Your phone's battery may drain faster when it is connected to HFL.
- If your phone is not ready for pairing or not found by the system within three minutes, the system will time out and return to idle.

Once you have paired a phone, you can see it displayed on the screen with one or two icons on the right side.

These icons indicate the following:

: The phone can be used with HFL.

: The phone is compatible with *Bluetooth*® Audio.

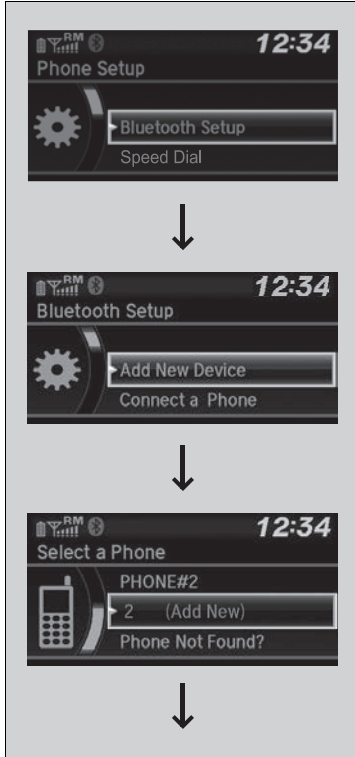

■ **To pair a cell phone (when a phone has already been paired to the system)**

1. Press the button or the button.
 - ▶ If a prompt appears asking to connect to a phone, select **No** and proceed with step 2.
2. Rotate to select **Phone Setup**, then press .
3. Rotate to select **Bluetooth Setup**, then press .
4. Rotate to select **Add New Device**, then press .
- ▶ The screen changes to device list.
5. Rotate to select **Add New**, then press .

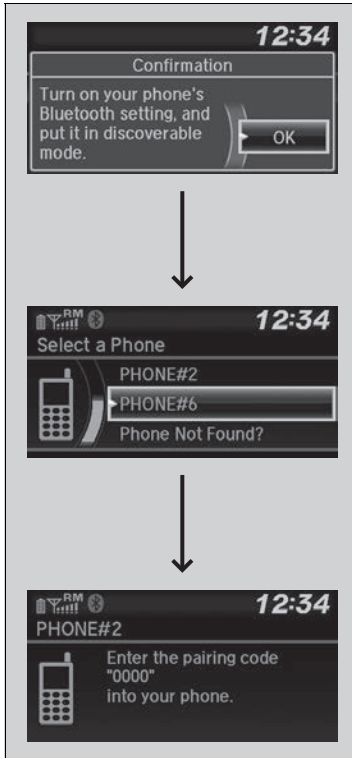

6. Make sure your phone is in search or discoverable mode, then press .
 - ▶ HFL automatically searches for a *Bluetooth*® device.

7. When your phone appears on the list, select it by pressing .
 - ▶ If your phone does not appear, select **Phone Not Found?** and search for *Bluetooth*® devices using your phone. From your phone, select **HandsFreeLink**.

8. The system gives you a pairing code on the audio/information screen.
 - ▶ Confirm if the pairing code on the screen and your phone match. This may vary by a phone.

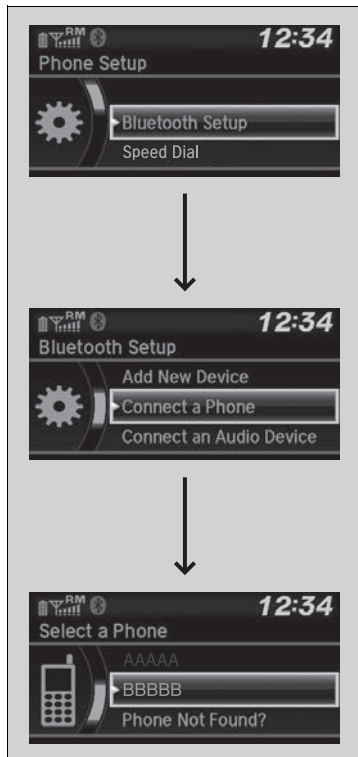

■ **To change the currently paired phone**

1. Press the button or the button.
2. Rotate to select **Phone Setup**, then press .
3. Rotate to select **Bluetooth Setup**, then press .
4. Rotate to select **Connect a Phone**, then press .
 - ▶ The screen changes to a device list.
5. Rotate to select a desired device name, then press .
 - ▶ HFL disconnects the connected phone and starts searching for another paired phone.

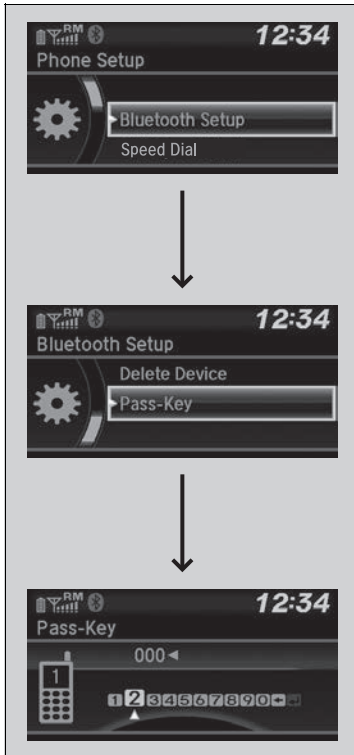

■ **To change the pairing code setting**

1. Press the button or the button.
2. Rotate to select **Phone Setup**, then press .
3. Rotate to select **Bluetooth Setup**, then press .
4. Rotate to select **Pass-Key**, then press .
5. Input a new pairing code, then press .

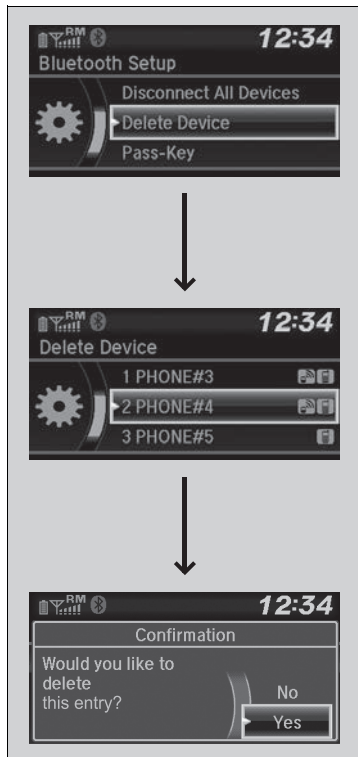

■ **To delete a paired phone**

1. Press the button or the button.
2. Rotate to select **Phone Setup**, then press .
3. Rotate to select **Bluetooth Setup**, then press .
4. Rotate to select **Delete Device**, then press .
 - ▶ The screen changes to a device list.
5. Rotate to select a phone you want to delete, then press .
6. A confirmation message appears on the screen. Rotate to select **Yes**, then press .

Ring Tone

You can change the ring tone setting.



1. Press the button or the button.
2. Rotate to select **Phone Setup**, then press .
3. Rotate to select **Ringtone**, then press .
4. Rotate to select **Mobile Phone** or **Fixed**, then press .

Caller's ID Information

You can select a caller's information to be displayed when you have an incoming call.

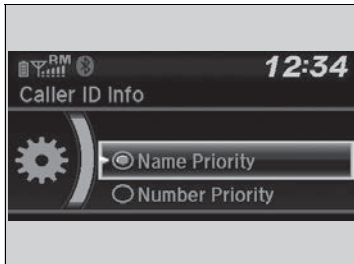

1. Press the button or the button.
2. Rotate to select **Phone Setup**, then press .
3. Rotate to select **Caller ID Info**, then press .
4. Rotate to select a mode you want, then press .

Ring Tone

Fixed: The fixed ring tone sounds from the speakers.
Mobile Phone: Depending on the make and model of the mobile phone, the ring tone stored in the phone will sound if the phone is connected.

Caller's ID Information

Name Priority: A caller's name is displayed if it is stored in the phonebook.
Number Priority: A caller's phone number is displayed.

■ To Clear the System

All speed dial entries, all imported phonebook data, all call history data, paired phones, pairing codes, caller's ID settings, and volume settings are reset as default.

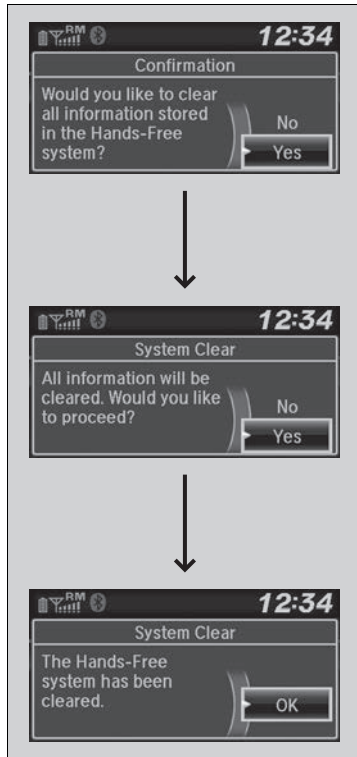

1. Press the button or the button.
 2. Rotate to select **Phone Setup**, then press .
 3. Rotate to select **System Clear**, then press .
 4. Rotate to select **Yes**, then press .
5. A confirmation message appears on the screen. Rotate to select **Yes**, then press .
6. A notification appears on the screen. Press .

Automatic Import of Cellular Phonebook and Call History

When your phone is paired, the contents of its phonebook and call history are automatically imported to HFL.



Automatic Import of Cellular Phonebook and Call History

When you select a name from the list in the cellular phonebook, you can see up to three category icons. The icons indicate what types of numbers are stored for that name.

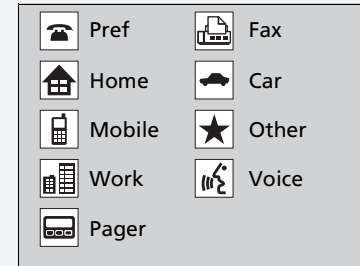

If a name has four or more numbers, ... appears instead of category icons.

On some phones, it may not be possible to import the category icons to HFL.

The phonebook is updated after every connection. Call history is updated after every connection or call.

■ Speed Dial

Up to 20 speed dial numbers can be stored per phone.



To store a speed dial number:

1. Press the button or the button.
2. Rotate to select **Speed Dial**, then press .
3. Rotate to select **Add New**, then press .
4. Rotate to select a place to choose a number from, then press .
 - From **Call History**:
 - ▶ Select a number from the call history.
 - From **Phonebook**:
 - ▶ Select a number from the connected cell phone's imported phonebook.
 - From **Phone Number**:
 - ▶ Input the number manually.
5. When the speed dial is successfully stored, you are asked to create a voice tag for the number. Rotate to select **Yes** or **No**, then press .
6. Using the button, follow the prompts to say the name for the speed dial entry.

▶▶ Speed Dial

When a voice tag is stored, you can press the button and call the number using voice commands.

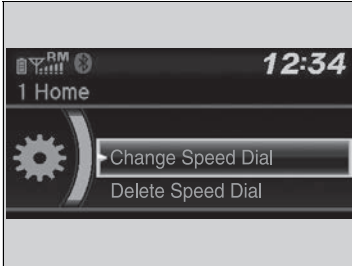

■ To edit a speed dial

1. Press the button or the button.
2. Rotate to select **Phone Setup**, then press .
3. Rotate to select **Speed Dial**, then press .
4. Select an existing speed dial entry.
5. Rotate to select **Change Speed Dial**, then press .
6. Select a new speed dial number, then press .

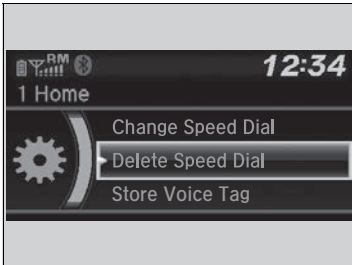

■ To delete a speed dial number

1. Press the button or the button.
2. Rotate to select **Phone Setup**, then press .
3. Rotate to select **Speed Dial**, then press .
4. Select an existing speed dial entry.
5. Rotate to select **Delete Speed Dial**, then press .
 - ▶ A confirmation message appears on the screen. Rotate to select **Yes**, then press .

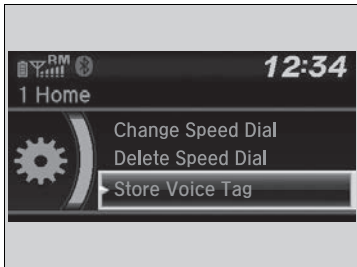

■ **To add a voice tag to a stored speed dial number**

1. Press the button or the button.
2. Rotate to select **Phone Setup**, then press .
3. Rotate to select **Speed Dial**, then press .
4. Select an existing speed dial entry.
5. Rotate to select **Store Voice Tag**, then press .
6. Using the button, follow the prompts to complete the voice tag.



■ **To change a voice tag**

1. Press the button or the button.
2. Rotate to select **Phone Setup**, then press .
3. Rotate to select **Speed Dial**, then press .
4. Select an existing speed dial entry.
5. Rotate to select **Change Voice Tag**, then press .
6. Using the button, follow the prompts to complete the voice tag.

▶▶ Speed Dial

Avoid using duplicate voice tags.
 Avoid using "home" as a voice tag.
 It is easier for HFL to recognize a longer name. For example, use "John Smith" instead of "John."

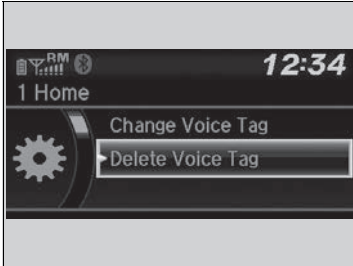

■ To delete a voice tag

1. Press the button or the button.
2. Rotate to select **Phone Setup**, then press .
3. Rotate to select **Speed Dial**, then press .
4. Select an existing speed dial entry.
5. Rotate to select **Delete Voice Tag**, then press .
 - ▶ A confirmation message appears on the screen. Rotate to select **Yes**, then press .

■ Making a Call

You can make calls by inputting any phone number, or by using the imported phonebook, call history, speed dial entries, or redial.

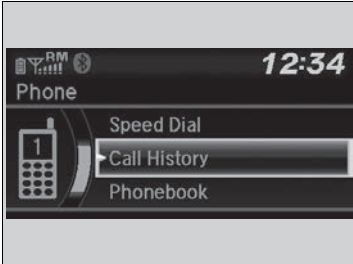

▶▶ Making a Call

Voice-tagged speed dial entries can be dialed by voice from any screen. Press the  button and follow the prompts.

Once a call is connected, you can hear the voice of the person you are calling through the audio speakers.

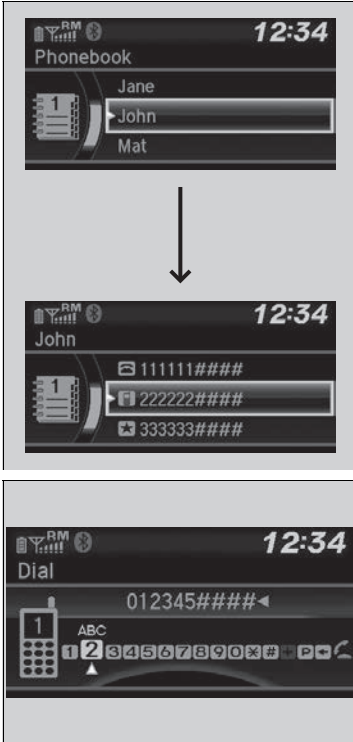

■ To make a call using the imported phonebook

When your phone is paired, the contents of its phonebook are automatically imported to HFL.

1. Press the button or the button.
 2. Rotate to select **Phonebook**, then press .
 3. The phonebook is stored alphabetically. Rotate to select the initial, then press .
 4. Rotate to select a name, then press .
 5. Rotate to select a number, then press .
- ▶ Dialing starts automatically.

■ To make a call using a phone number

1. Press the button or the button.
 2. Rotate to select **Dial**, then press .
 3. Rotate to select a number, then press .
 4. Rotate to select , then press .
- ▶ Dialing starts automatically.

☒ To make a call using the imported phonebook

This function is disabled while the vehicle is moving. However, you can call a stored voice-tagged speed dial number using voice commands.

- **Limitations for Manual Operation** P. 352
- **Speed Dial** P. 366

☒ To make a call using a phone number

This function is disabled while the vehicle is moving. However, you can call a stored voice-tagged speed dial number using voice commands.

- **Limitations for Manual Operation** P. 352
- **Speed Dial** P. 366

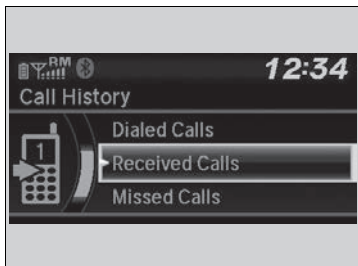

■ To make a call using redial

1. Press the button or the button.
 2. Rotate to select **Redial**, then press .
- ▶ Dialing starts automatically.

■ To make a call using the call history

Call history is stored by **Dialed Calls**, **Received Calls**, and **Missed Calls**.

1. Press the button or the button.
 2. Rotate to select **Call History**, then press .
 3. Rotate to select **Dialed Calls**, **Received Calls**, or **Missed Calls**, then press .
 4. Rotate to select a number, then press .
- ▶ Dialing starts automatically.

▶▶ To make a call using redial

Press and hold the button to redial the last number dialed in your phone's call history.

▶▶ To make a call using the call history

The call history appears only when a phone is connected to HFL, and displays the last 20 dialed, received, or missed calls. (Appears only when a phone is connected to the system.)

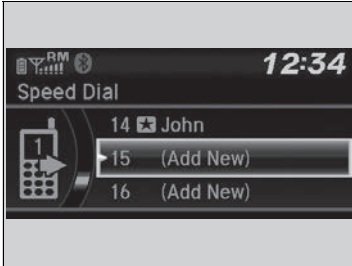

■ **To make a call using a speed dial entry**

1. Press the button or the button.
2. Rotate to select **Speed Dial**, then press .
3. Rotate to select a number, then press .
 - ▶ Dialing starts automatically.

☒ To make a call using a speed dial entry

When a voice tag is stored, press the button and call the number using voice commands.

▶ **Speed Dial** P. 366

Voice-tagged speed dial entries can be dialed by voice from any screen. Press the button and follow the prompts.

Continued

Receiving a Call

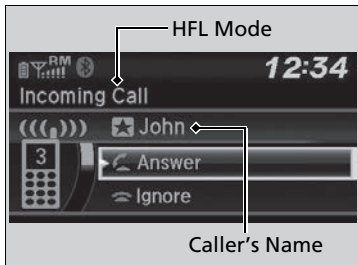

When there is an incoming call, an audible notification sounds and the **Incoming Call** screen appears.

Press the  button to answer the call.

Press the  button to decline or end the call.

Receiving a Call





Call Waiting

Press the  button to put the current call on hold to answer the incoming call.

Press the  button again to return to the current call.

Select **Ignore** to ignore the incoming call if you do not want to answer it.

Press the  button if you want to hang up the current call.

You can select the icons on the audio/information screen instead of the  and  buttons. Rotate  to select the icon, then press .

Options During a Call

The following options are available during a call.



Swap Call: Put the current call on hold to answer the incoming call.

Mute: Mute your voice.

Transfer Call: Transfer a call from HFL to your phone.

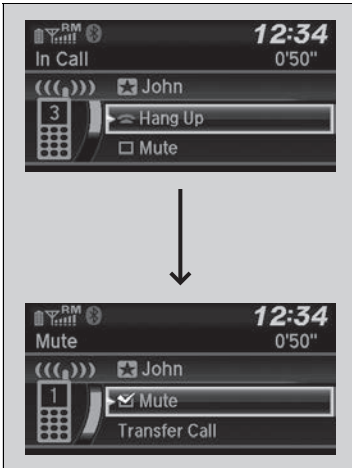
Dial Tones: Send numbers during a call. This is useful when you call a menu-driven phone system.



1. To view the available options, press the  button.
2. Rotate  to select the option, then press .
 - ▶ The check box is checked when **Mute** is selected. Select **Mute** again to turn it off.

Options During a Call

Dial Tones: Available on some phones.

Models with Display Audio

Bluetooth® HandsFreeLink® (HFL) allows you to place and receive phone calls using your vehicle's audio system, without handling your cell phone.

Using HFL

HFL Buttons

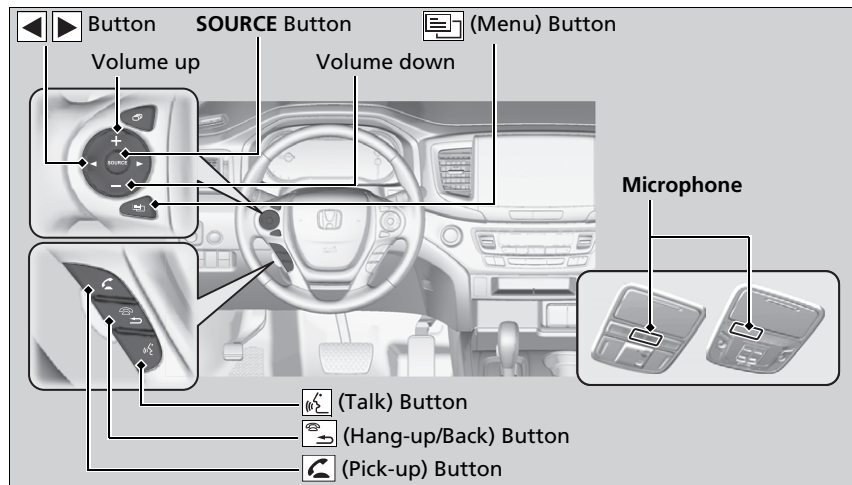

Bluetooth® HandsFreeLink®

Place your phone where you can get good reception.

To use HFL, you need a *Bluetooth*-compatible cell phone. For a list of compatible phones, pairing procedures, and special feature capabilities, ask a dealer or your Honda dealer.

To use the system, the **Bluetooth On/Off Status** setting must be **On**.

➤ **How to customize** P. 323

Voice control tips

- Aim the vents away from the ceiling and close the windows, as noise coming from them may interfere with the microphones.
- Press the  button when you want to call a number using a stored voice tag. Speak clearly and naturally after a beep.
- If the microphones pick up voices other than yours, the command may be misinterpreted.
- To change the volume level, select the audio system's **VOL** (Volume) or use the remote audio controls on the steering wheel.

Up to five speed dial entries can be displayed among a total of 20 that can be entered. If there is no entry in the system, Speed Dial is disabled.

➤ **Speed Dial** P. 390

Up to five call histories can be displayed among a total of 20 that can be entered. If there is no call history, Call History is disabled.

 **(Pick-up) button:** Press to go directly to the phone screen, or to answer an incoming call.

 **(Hang-up/back) button:** Press to end a call, go back to the previous command, or cancel a command.



 **(Talk) button:** Press to call a number with a stored voice tag.

 **(Menu) button:** Press to display **Speed Dial**, **Call History**, or **Redial** on the phone screen.

 **button:** Press to select an item displayed on the phone screen.

SOURCE button: Press to call a number listed in the selected item on the phone screen.

To go to the **Phone menu** screen:

1. Select .
2. Select **Phone** to switch the display to the phone screen.
3. Select .

Bluetooth® HandsFreeLink®

Bluetooth® Wireless Technology

The *Bluetooth®* word mark and logos are registered trademarks owned by *Bluetooth SIG, Inc.*, and any use of such marks by Honda Motor Co., Ltd., is under license. Other trademarks and trade names are those of their respective owners.

HFL Limitations

An incoming call on HFL will interrupt the audio system when it is playing. It will resume when the call is ended.

■ HFL Status Display

The audio/information screen notifies you when there is an incoming call.

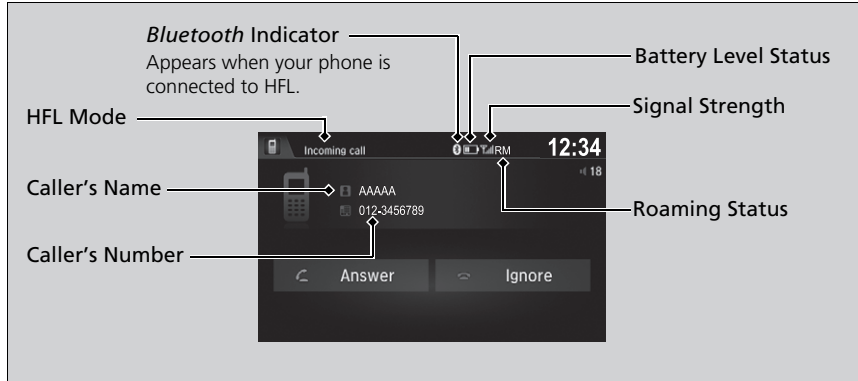

■ Limitations for Manual Operation

Certain manual functions are disabled or inoperable while the vehicle is in motion. You cannot select a grayed-out option until the vehicle is stopped.

Only previously stored speed dial entries with voice tags, phonebook names, or numbers can be called using voice commands while the vehicle is in motion.

▶ **Speed Dial** P. 390

▶▶ HFL Status Display

The information that appears on the audio/information screen varies between phone models.

You can change the system language.

▶ **How to customize** P. 323

HFL Menus

The power mode must be in ACCESSORY or ON to use the system.

■ Phone settings screen

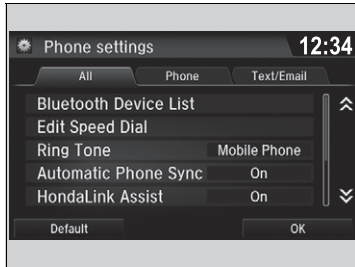

1. Select .
2. Select **Settings**.
3. Select **Phone**.

☒ HFL Menus

To use HFL, you must first pair your *Bluetooth*-compatible cell phone to the system while the vehicle is parked.

Some functions are limited while driving.

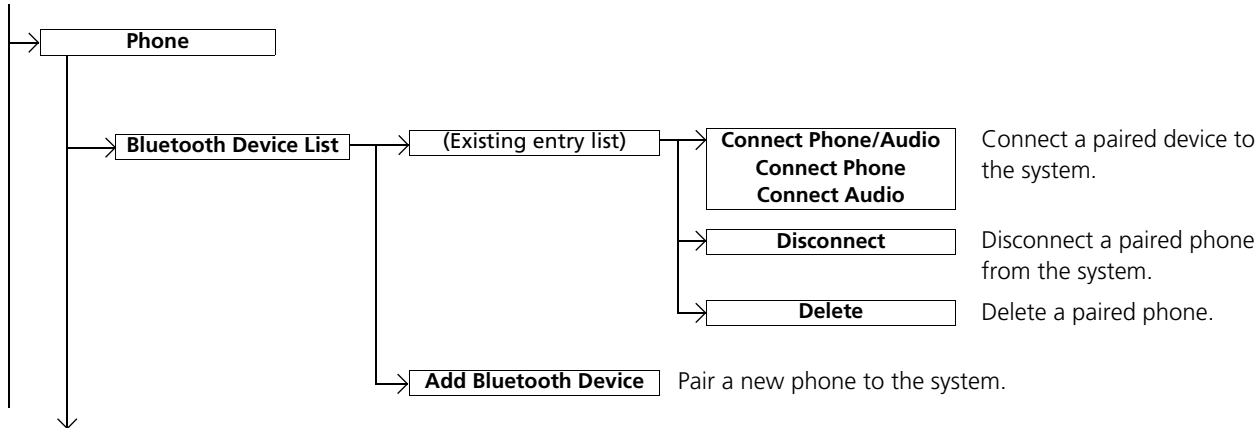

Connect a paired device to the system.

Disconnect a paired phone from the system.

Delete a paired phone.

Pair a new phone to the system.

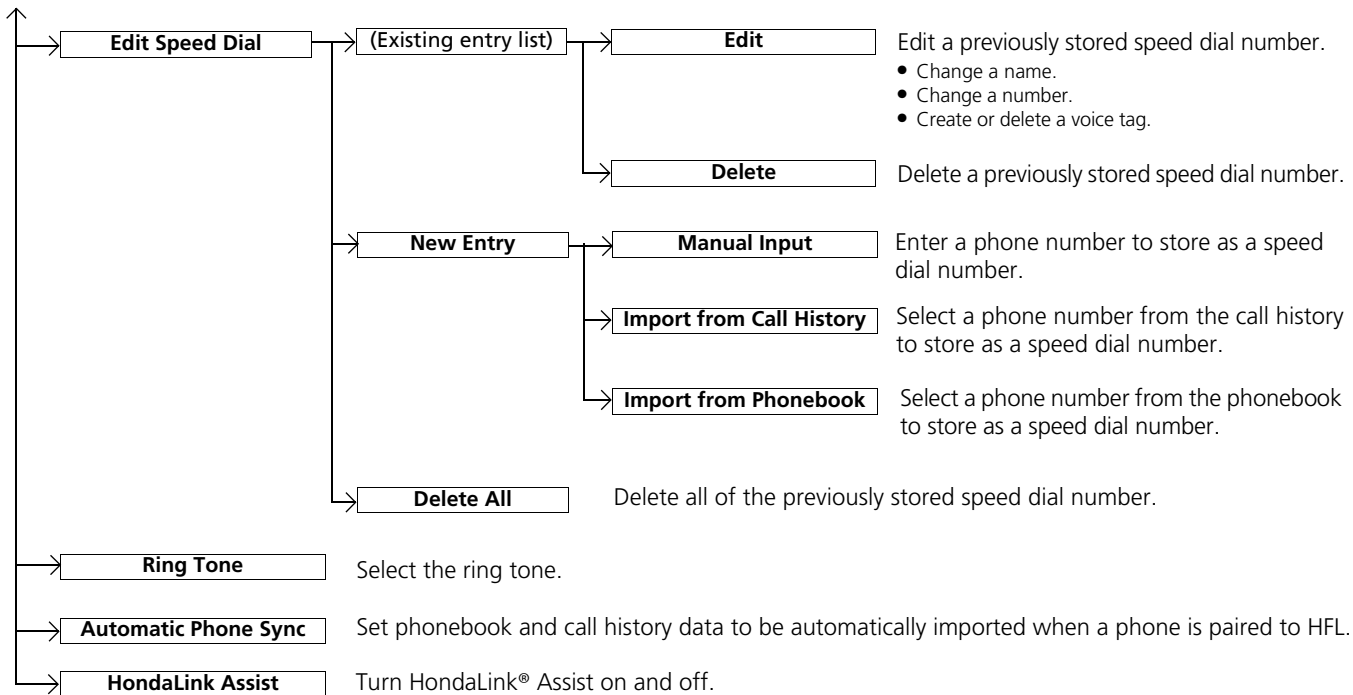

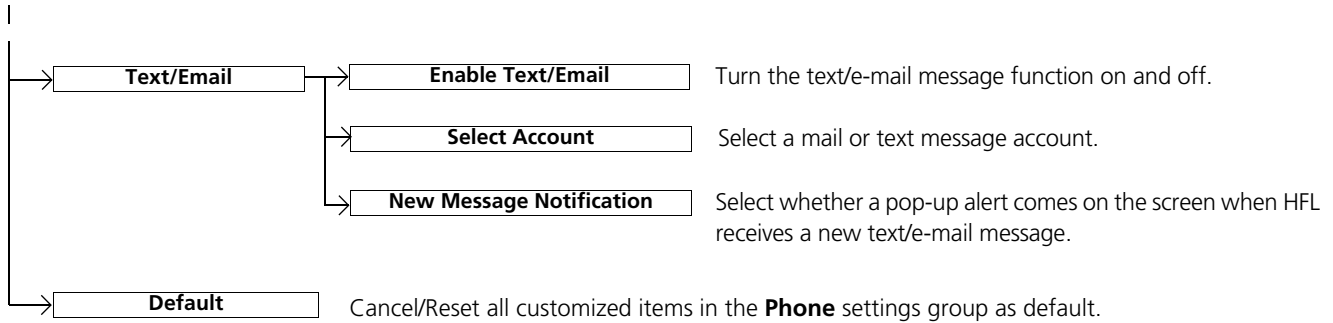

Phone menu screen

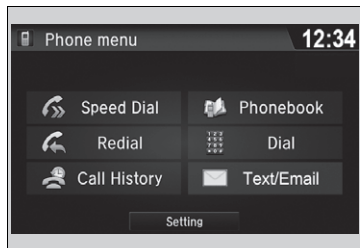

1. Select .
2. Select **Phone**.
3. Select .

Features

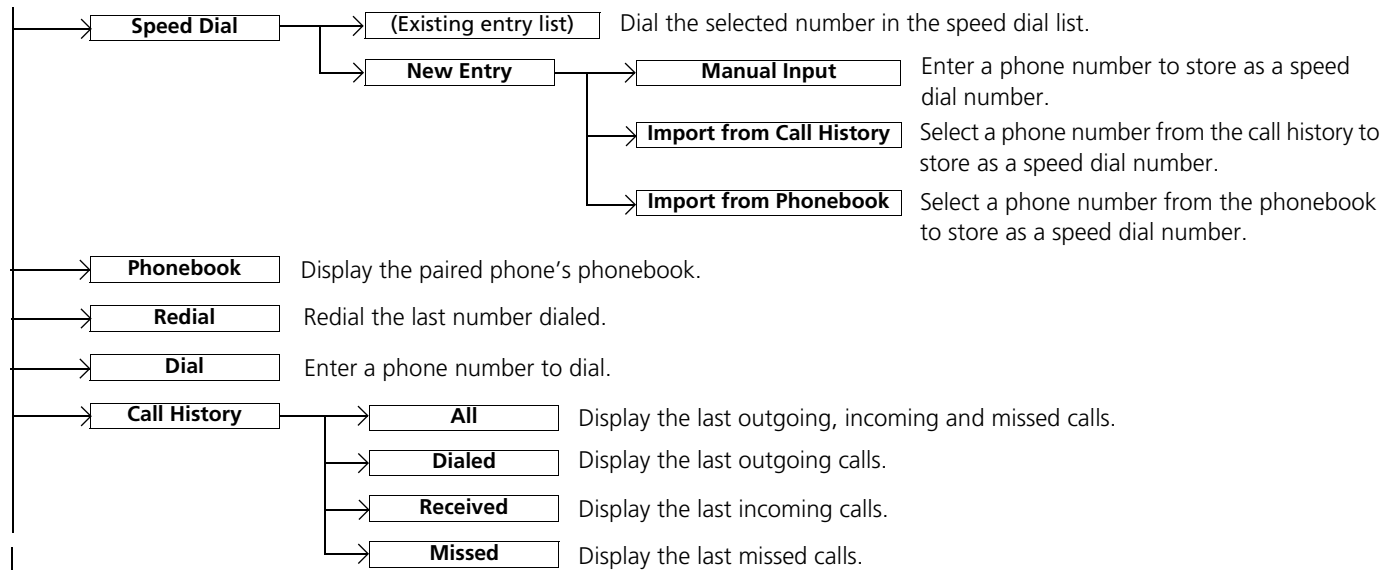

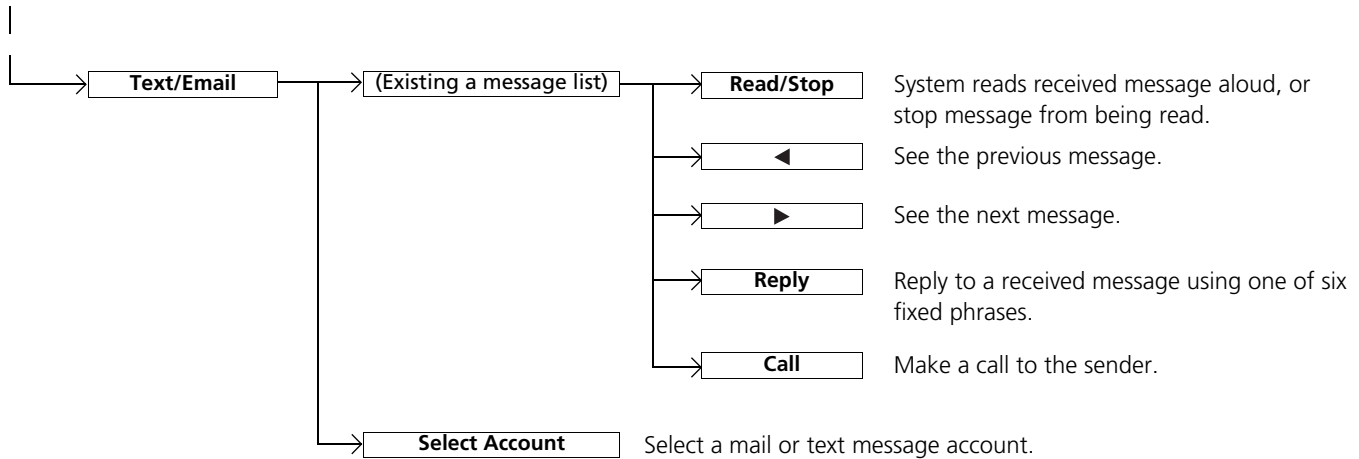

Phone Setup

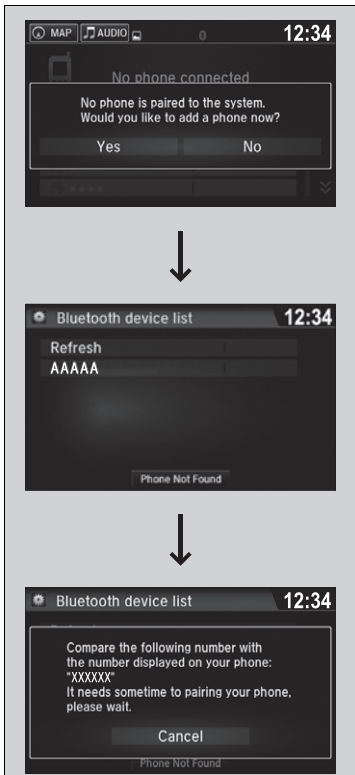

■ To pair a cell phone (when there is no phone paired to the system)

1. Select .
2. Select **Phone**.
3. Select **Yes**.
4. Make sure your phone is in search or discoverable mode, then select **Continue**.
 - ▶ HFL automatically searches for a *Bluetooth*® device.
5. Select your phone when it appears on the list.
 - ▶ If your phone does not appear, you can select **Refresh** to search again.
 - ▶ If your phone still does not appear, select **Phone Not Found** and search for *Bluetooth*® devices using your phone. From your phone, search for **HandsFreeLink**.
6. The system gives you a pairing code on the audio/information screen.
 - ▶ Confirm if the pairing code on the screen and your phone match. This may vary by phone.

▶▶ Phone Setup

Your *Bluetooth*-compatible phone must be paired to the system before you can make and receive hands-free calls.

Phone Pairing Tips:

- You cannot pair your phone while the vehicle is moving.
- Up to six phones can be paired.
- Your phone's battery may drain faster when it is paired to the system.
- If your phone is not ready for pairing or not found by the system within three minutes, the system will time out and return to idle.

Once you have paired a phone, you can see it displayed on the screen with one or two icons on the right side.

These icons indicate the following:



The phone can be used with HFL.





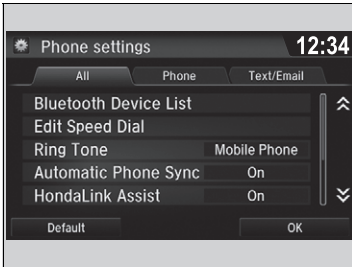

The phone is compatible with *Bluetooth*® Audio.

If there is an active connection to Apple CarPlay or Android Auto, pairing of additional *Bluetooth* compatible devices is unavailable and **Add Bluetooth Device** is grayed out from the **Bluetooth device list** screen.



■ **To change the currently paired phone**

1. Go to the **Phone settings** screen.
 - ▶ **Phone settings screen** P. 379
2. Select **Bluetooth Device List**.
3. Select a phone to connect.
 - ▶ HFL disconnects the connected phone and starts searching for another paired phone.
4. Select **Connect**  , **Connect** , or **Connect** .

■ **To change the pairing code setting**

1. Select .
 2. Select **Settings**.
 3. Select **Bluetooth/Wi-Fi**.
 4. Select the **Bluetooth** tab.
 5. Select **Edit Pairing Code**.
-
6. Select **Random** or **Fixed**.

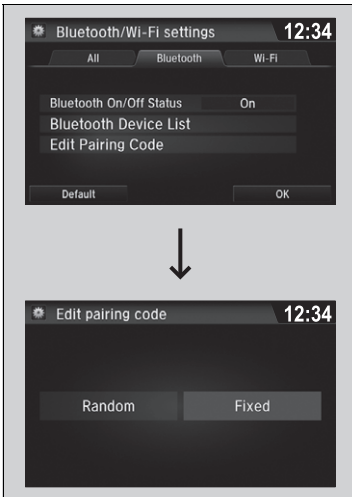

▶▶ To change the currently paired phone

If no other phones are found or paired when trying to switch to another phone, HFL will inform you that the original phone is connected again.

To pair other phones, select **Add Bluetooth Device** from the **Bluetooth device list** screen.

▶▶ To change the pairing code setting

The default pairing code is **0000** until you change the setting.
To create your own, select **Fixed**, and delete the current code, then enter a new one.

For a randomly generated pairing code each time you pair a phone, select **Random**.

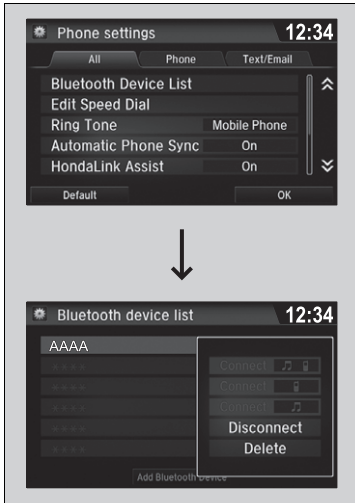

■ **To delete a paired phone**

1. Go to the **Phone settings** screen.
 - ▶ **Phone settings screen** P. 379
2. Select **Bluetooth Device List**.
3. Select a phone you want to delete.
4. Select **Delete**.
5. A confirmation message appears on the screen. Select **Yes**.

To Set Up Text Message/E-mail Options

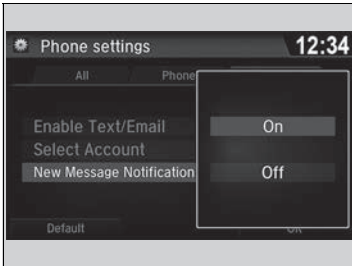
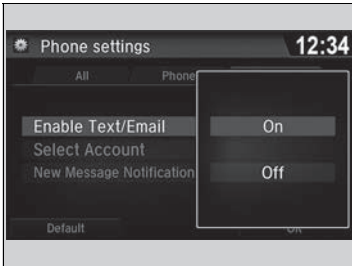

■ To turn on or off the text/e-mail function

1. Go to the **Phone settings** screen.
 - ▶ **Phone settings screen** P. 379
2. Select the **Text/Email** tab, then **Enable Text/Email**.
 - ▶ A pop-up menu appears on the screen.
3. Select **On** or **Off**.

■ To turn on or off the text/e-mail notice

1. Go to the **Phone settings** screen.
 - ▶ **Phone settings screen** P. 379
2. Select the **Text/Email** tab, then **New Message Notification**.
 - ▶ A pop-up menu appears on the screen.
3. Select **On** or **Off**.

☒ To Set Up Text Message/E-mail Options

To use the text message/e-mail function, it may be necessary to set up on your phone.

☒ To turn on or off the text/e-mail notice

- On:** A pop-up notification comes on every time you receive a new message.
- Off:** The message you receive is stored in the system without notification.

■ Ring Tone

You can change the ring tone setting.



1. Go to the **Phone settings** screen.
 ▶ **Phone settings screen** P. 379
2. Select **Ring Tone**.
3. Select **Fixed** or **Mobile Phone**.

▶▶ Ring Tone

Fixed: The fixed ring tone sounds from the speakers.
Mobile Phone: Depending on the make and model of the mobile phone, the ring tone stored in the phone will sound if the phone is connected.

Automatic Import of Cellular Phonebook and Call History

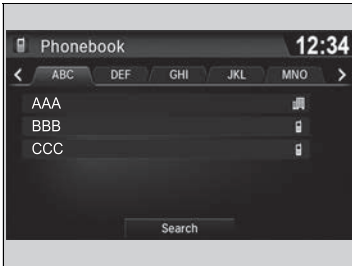

■ When Automatic Phone Sync is set to On:

When your phone is paired, the contents of its phonebook and call history are automatically imported to the system.

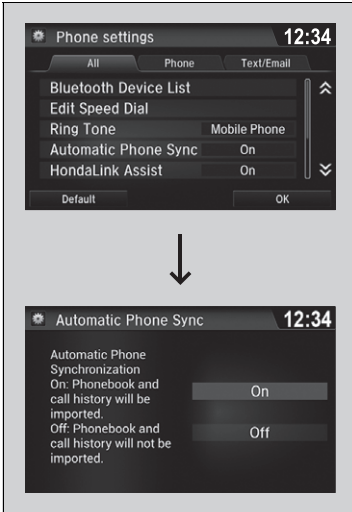

■ Changing the Automatic Phone Sync setting

1. Go to the **Phone settings** screen.
 ▶ **Phone settings screen** P. 379
2. Select **Automatic Phone Sync**.
3. Select **On** or **Off**.

⊠ Automatic Import of Cellular Phonebook and Call History

When you select a name from the list in the cellular phonebook, you can see up to three category icons. The icons indicate what types of numbers are stored for that name.

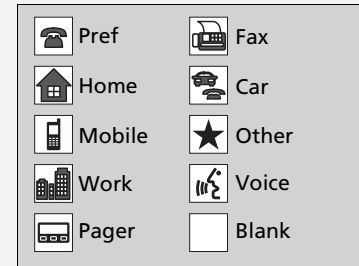

On some phones, it may not be possible to import the category icons to the system.

The phonebook is updated after every connection. Call history is updated after every connection or call.

Speed Dial

Up to 20 speed dial numbers can be stored per phone.

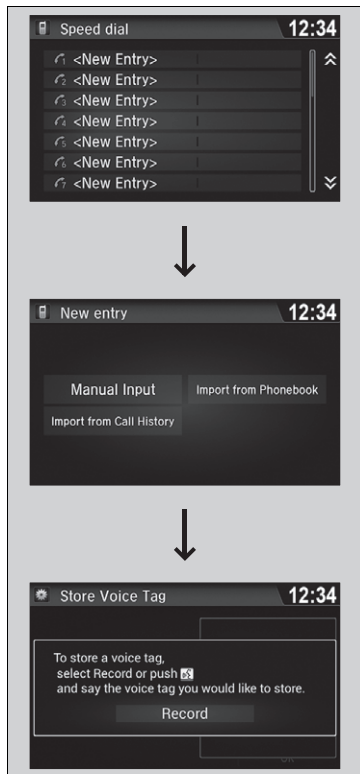

To store a speed dial number:

1. Go to the **Phone menu** screen.

▶ **Phone menu screen** P. 382

2. Select **Speed Dial**.

3. Select **New Entry**.

From **Import from Call History**:

▶ Select a number from the call history.

From **Manual Input**:

▶ Input the number manually.

From **Import from Phonebook**:

▶ Select a number from the connected cell phone's imported phonebook.

4. When the speed dial is successfully stored, you are asked to create a voice tag for the number. Select **Yes** or **No**.

5. Select **Record** to store a voice tag for the speed dial entry.

▶ Using the [RECORD] button, follow the prompts to store a voice tag for the speed dial entry.

Speed Dial

When a voice tag is stored, press the [RECORD] button to call the number using the voice tag. Say the voice tag name.

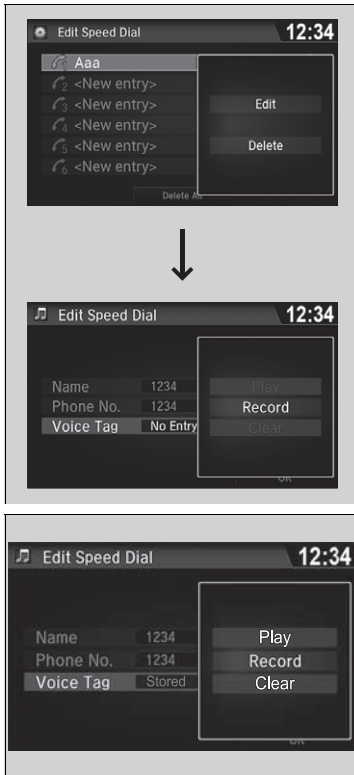

■ To add a voice tag to a stored speed dial number

1. Go to the **Phone settings** screen.
 ▶ **Phone settings screen** P. 379
2. Select **Edit Speed Dial**.
3. Select an existing speed dial entry.
 ▶ From the pop-up menu, select **Edit**.
4. Select **Voice Tag**.
 ▶ From the pop-up menu, select **Record**.
5. Select **Record**, or use the  button and follow the prompts to complete the voice tag.

■ To delete a voice tag

1. Go to the **Phone settings** screen.
 ▶ **Phone settings screen** P. 379
2. Select **Edit Speed Dial**.
3. Select an existing speed dial entry.
 ▶ From the pop-up menu, select **Edit**.
4. Select **Voice Tag**.
 ▶ From the pop-up menu, select **Clear**.
5. A confirmation message appears on the screen. Select **Yes**.

⌘ Speed Dial

Avoid using duplicate voice tags.
 Avoid using "home" as a voice tag.
 It is easier for the system to recognize a longer name.
 For example, use "John Smith" instead of "John."

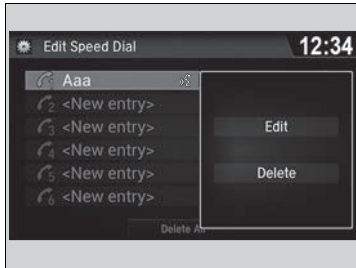

■ To edit a speed dial

1. Go to the **Phone settings** screen.
 - ▶ **Phone settings screen** P. 379
2. Select **Edit Speed Dial**.
3. Select an existing speed dial entry.
 - ▶ From the pop-up menu, select **Edit**.
4. Select a setting you want.

■ To delete a speed dial

1. Go to the **Phone settings** screen.
 - ▶ **Phone settings screen** P. 379
2. Select **Edit Speed Dial**.
3. Select an existing speed dial entry.
 - ▶ From the pop-up menu, select **Delete**.
4. A confirmation message appears on the screen. Select **Yes**.

Phonebook Phonetic Modification

Add phonetic modifications or a new voice tag to the phone's contact name so that it is easier for HFL to recognize voice commands.

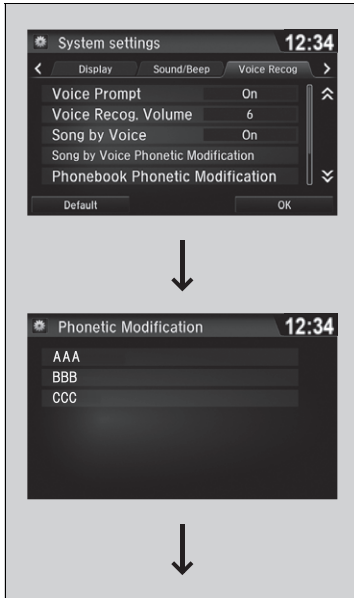

■ To add a new voice tag

1. Select .
2. Select **Settings**.
3. Select **System**.
4. Select the **Voice Recog** tab.
5. Select **Phonebook Phonetic Modification**.
6. Select the phone you want to add phonetic modification to.

☒ Phonebook Phonetic Modification

You can store up to 20 phonetic modification items.

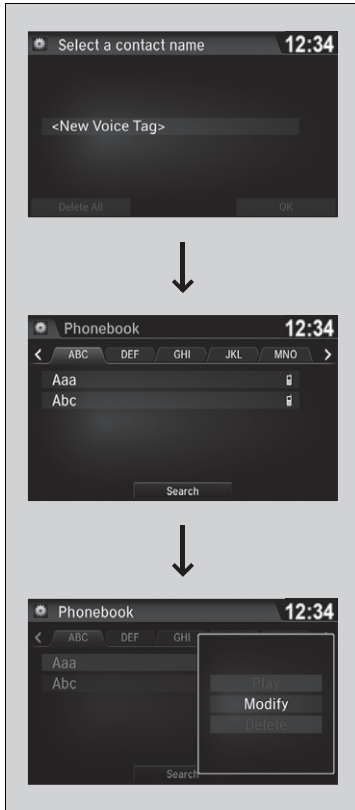

7. Select **New Voice Tag**.

8. Select a contact name you want to add to.

▶ The pop-up menu appears on the screen.



9. Select **Modify**.

10. Using **Record** or the  button, follow the prompts to complete the voice tag.

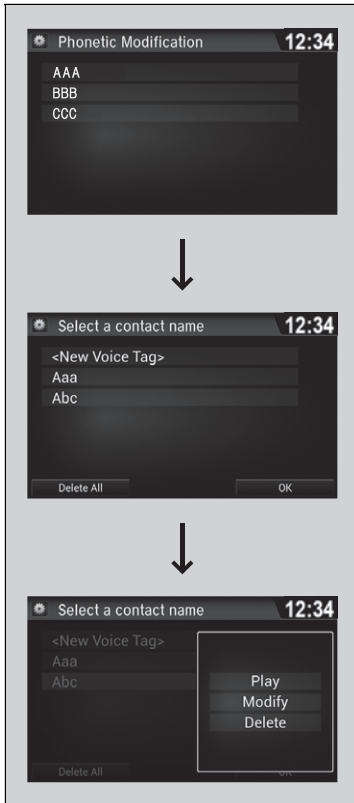
11. You will receive a confirmation message on the screen, then select **OK**.



■ To modify a voice tag

1. Select .
2. Select **Settings**.
3. Select **System**.
4. Select the **Voice Recog** tab.
5. Select **Phonebook Phonetic Modification**.
6. Select the phone you want to modify phonetic modification.
7. Select a contact name you want to modify.
 - ▶ The pop-up menu appears on the screen.
8. Select **Modify**.
9. Using **Record** or the  button, follow the prompts to complete the voice tag.
10. You will receive a confirmation message on the screen, then select **OK**.
11. Select **OK**.

☒ Phonebook Phonetic Modification

You can only modify or delete contact names for the currently connected phone.



■ To delete a modified voice tag

1. Select .
2. Select **Settings**.
3. Select **System**.
4. Select the **Voice Recog** tab.
5. Select **Phonebook Phonetic Modification**.
6. Select the phone you want to delete phonetic modification.
7. Select a contact name you want to delete.
 - ▶ The pop-up menu appears on the screen.
8. Select **Delete**.
 - ▶ The selected contact name has been selected.
9. Select **OK**.

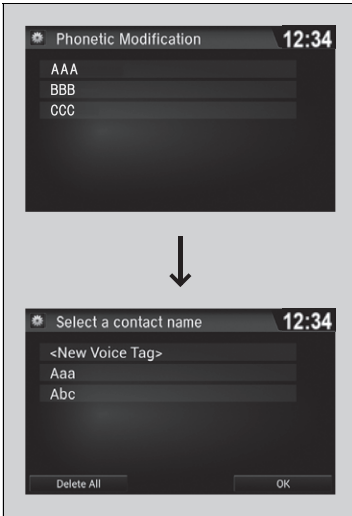

■ To delete all modified voice tags

1. Select .
2. Select **Settings**.
3. Select **System**.
4. Select the **Voice Recog** tab.
5. Select **Phonebook Phonetic Modification**.
6. Select the phone you want to delete phonetic modification.
 - ▶ The contact name list appears.
7. Select **Delete All**.
8. You will receive a confirmation message on the screen, then select **Yes**.

■ Making a Call

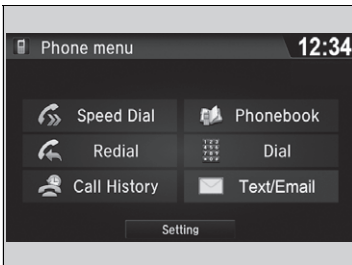

You can make calls by inputting any phone number, or by using the imported phonebook, call history, speed dial entries, or redial.

☒ Making a Call

Any voice-tagged speed dial entry can be dialed by voice from most screens.

Press the  button and say the voice tag name.

Once a call is connected, you can hear the voice of the person you are calling through the audio speakers.

While there is an active connection with Apple CarPlay, phone calls cannot be made with HandsFreeLink® and are only made from Apple CarPlay.

Continued



■ To make a call using the imported phonebook

1. Go to the **Phone menu** screen.
 - ▶ **Phone menu screen** P. 382
2. Select **Phonebook**.
3. Select a name.
 - ▶ You can also search by letter. Select **Search**.
 - ▶ Use the keyboard on the touch screen for entering name, if multiple numbers exist select a number.
4. Select a number.
 - ▶ Dialing starts automatically.

■ To make a call using a phone number

1. Go to the **Phone menu** screen.
 - ▶ **Phone menu screen** P. 382
2. Select **Dial**.
3. Select a number.
 - ▶ Use the keyboard on the touch screen for entering numbers.
4. Select **Dial**.
 - ▶ Dialing starts automatically.

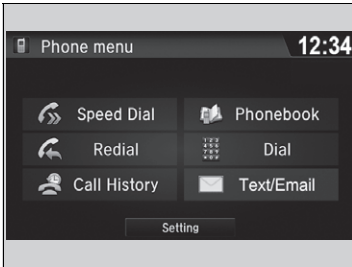

■ **To make a call using redial**

1. Go to the **Phone menu** screen.
 ▶ **Phone menu screen** P. 382
2. Select **Redial**.
 ▶ Dialing starts automatically.

☒ To make a call using redial

Press and hold the  button to redial the last number dialed.

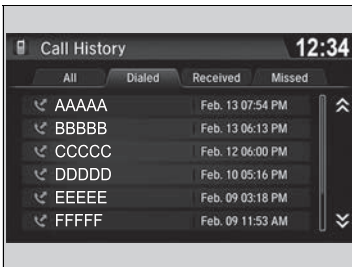

■ **To make a call using the Call History**

Call history is stored by **All, Dialed, Received, and Missed**.

1. Go to the **Phone menu** screen.
 ▶ **Phone menu screen** P. 382
2. Select **Call History**.
3. Select **All, Dialed, Received, or Missed**.
4. Select a number.
 ▶ Dialing starts automatically.

☒ To make a call using the Call History

The call history displays the last 20 all, dialed, received, or missed calls. (Appears only when a phone is connected to the system.)

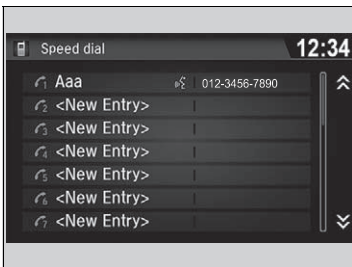

■ **To make a call using a Speed Dial entry**

1. Go to the **Phone menu** screen.
 ▶ **Phone menu screen** P. 382
2. Select **Speed Dial**.
3. Select a number.
 ▶ Dialing starts automatically.

☒ To make a call using a Speed Dial entry

When a voice tag is stored, press the  button to call the number using the voice tag.

▶ **Speed Dial** P. 390

Any voice-tagged speed dial entry can be dialed by voice from any screen.

Press the  button and follow the prompts.

Receiving a Call

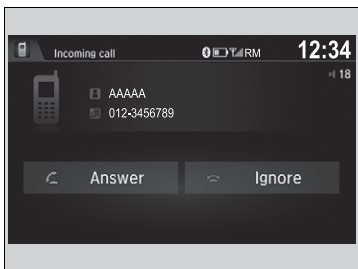

When there is an incoming call, an audible notification sounds (if activated) and the **Incoming call** screen appears.

Press the button to answer the call.
 Press the button to decline or end the call.

Options During a Call

The following options are available during a call.

Mute: Mute your voice.

Transfer: Transfer a call from the system to your phone.

Touch Tones: Send numbers during a call. This is useful when you call a menu-driven phone system.

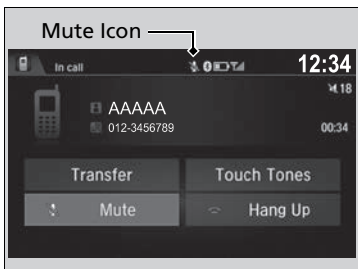

The available options are shown on the lower half of the screen.

Select the option.

▶ The mute icon appears when **Mute** is selected. Select **Mute** again to turn it off.

Receiving a Call

Call Waiting
 Press the button to put the current call on hold to answer the incoming call.
 Press the button again to return to the current call.
 Select **Ignore** to ignore the incoming call if you do not want to answer it.
 Press the button if you want to hang up the current call.

You can select the icons on the audio/information screen instead of the and buttons.

Options During a Call

Touch Tones: Available on some phones.

You can select the icons on the audio/information screen.

Receiving a Text Message/E-mail

HFL can display newly received text or e-mail messages as well as the last 20 messages received on a linked cell phone. Each received message can be read aloud and replied to using a fixed common phrase.



1. A pop-up appears and notifies you of a new text message or e-mail.
2. Select **Read** to listen to the message.
 - ▶ The text message or e-mail is displayed. The system automatically starts reading out the message.
3. To discontinue the message read-out, select **Stop**.

Receiving a Text Message/E-mail

The system does not display any received messages while you are driving. You can only hear them read aloud.

The system can only receive messages that are sent a text (SMS) messages. The message sent using the data services will not be displayed in the list.

With some phones, you may be able to display up to 20 of the last text messages and/or e-mails received.

State or local laws may limit your use of the HFL text message/e-mail feature. Only use the text message/e-mail feature when conditions allow you to do so safely.

When you receive a text message or e-mail for the first time since the phone is paired to HFL, you are asked to turn the **New Message Notification** setting to **On**.

▶ **To turn on or off the text/e-mail notice**
P. 387

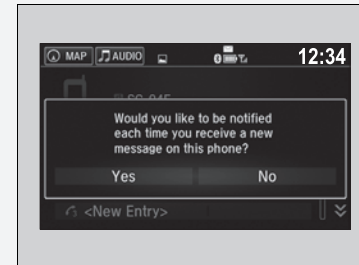

Continued

■ Selecting a Mail Account

If a paired phone has text message or mail accounts, you can select one of them to be active and receive notifications.

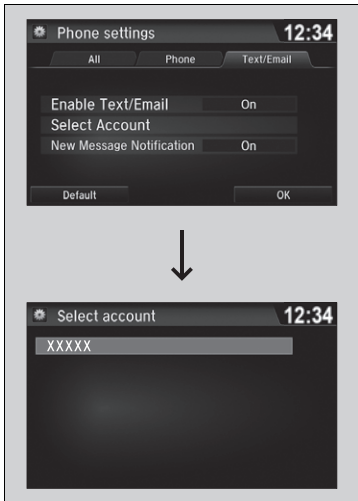

1. Go to the **Phone settings** screen.
 - ▶ **Phone settings screen** P. 379
2. Select the **Text/Email** tab, then **Select Account**.
 - ▶ A pop-up menu appears on the screen.
3. Select **Text Messages** or an e-mail account you want.

▶▶ Selecting a Mail Account

You can also select a mail account from the folder list screen or the message list screen.

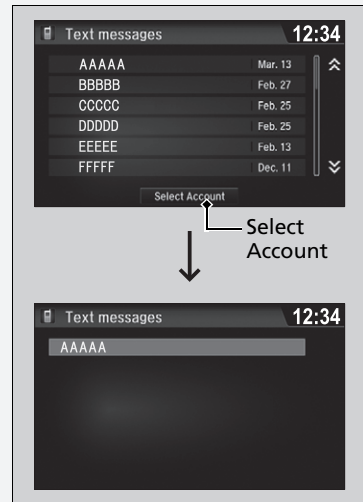

You can only receive notifications from one text message or mail account at a time.

Displaying Messages



■ Displaying text messages

1. Go to the **Phone menu** screen.
 - ▶ **Phone menu screen** P. 382
2. Select **Text/Email**.
 - ▶ Select account if necessary.
3. Select a message.
 - ▶ The text message is displayed. The system automatically starts reading the message aloud.

☒ Displaying Messages

The ☒ icon appears next to an unread message.

If you delete a message on the phone, the message will also be deleted from the system. If you send a message from the system, the message goes to your phone's outbox.

To see the previous or next message, select ◀ or ▶ on the message screen.

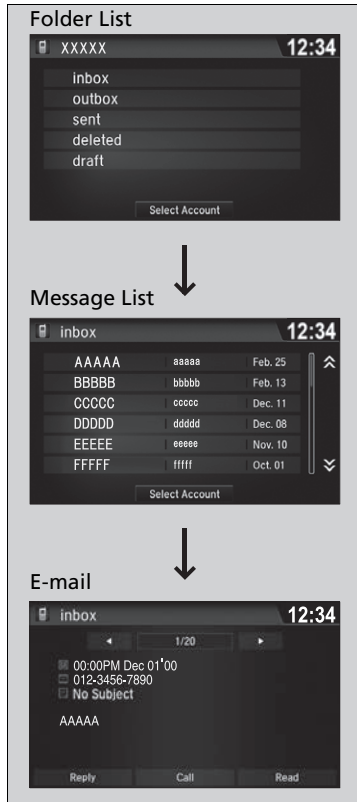

■ Displaying e-mails

1. Go to the **Phone menu** screen.
 - ▶ **Phone menu screen** P. 382
2. Select **Text/Email**.
 - ▶ Select **Select Account** if necessary.
3. Select a folder.
 - ▶ Select a message.
4. Select a message.
 - ▶ The e-mail is displayed. The system automatically starts reading the message aloud.

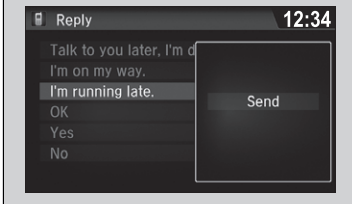
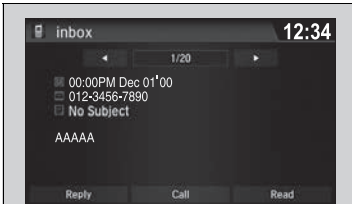
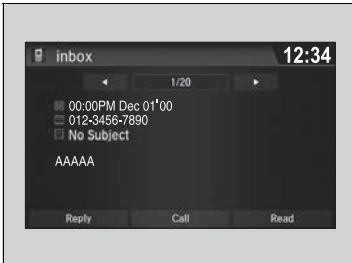

■ Read or Stop reading a message

1. Go to the text or e-mail message screen.
 - ▶ The system automatically starts reading the message aloud.
 - ▶ **Displaying Messages** P. 403
2. Select **Stop** to stop reading.
 - Select **Read** again to start reading the message from the beginning.

■ Reply to a message

1. Go to the text or e-mail message screen.
 - ▶ The system automatically starts reading the message aloud.
 - ▶ **Displaying Messages** P. 403
2. Select **Reply**.
3. Select the reply message.
 - ▶ The pop-up menu appears on the screen.
4. Select **Send** to send the message.
 - ▶ **Message sent** appears on the screen when the reply message was successfully sent.

▶▶ Reply to a message

The available fixed reply messages are as follows:

- **Talk to you later, I'm driving.**
- **I'm on my way.**
- **I'm running late.**
- **OK**
- **Yes**
- **No**

You cannot add, edit, or delete reply messages.

Only certain phones receive and send messages when paired and connected. For a list of compatible phones:

- U.S.: Visit automobiles.honda.com/handsfreelink/, or call 1-888-528-7876.
- Canada: Visit www.handsfreelink.ca, or call 1-888-528-7876.

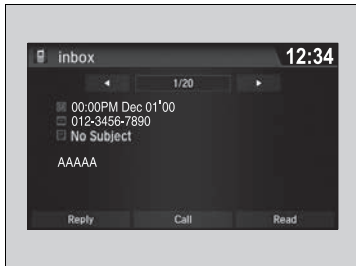

■ Making a call to a sender

1. Go to the text message screen.
2. Select **Call**.

In Case of Emergency

Automatic collision notification

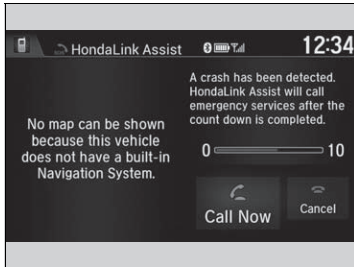

If your vehicle's airbags deploy or if the unit detects that the vehicle is severely impacted, your vehicle automatically will attempt to connect to the HondaLink® operator. If connected, information about your vehicle, its location, and its condition will be sent to the operator; you also can speak to the operator when connected.

IMPORTANT: For vehicles equipped with HondaLink® Assist, owner activation constitutes authorization for Honda to collect information from your vehicle needed to provide the service, and agreement to the Terms of Use at www.hondalink.com/TermsAndConditions. In a crash, HondaLink® Assist will attempt to notify emergency services but NEITHER HONDA NOR ITS SERVICE PROVIDERS GUARANTEE THAT SUCH NOTIFICATION WILL OCCUR.

Honda reserves the right to terminate HondaLink® Assist services at any time or for any reason, and in the future may not be able to provide services due to changes in, or obsolescence of, technology integral to the service or changes in governmental regulation.

In Case of Emergency

Your vehicle may not be able to connect to the operator if the battery level is low, the line is disconnected, or you do not have adequate cellular coverage.

You cannot use this emergency services when:

- You travel outside the HondaLink® service coverage areas.
- There is a problem with the connecting devices, such as the microphones, speakers, or the unit itself.

You cannot operate other phone-related functions using the screen while talking to the operator. Select **Hang Up** to terminate the connection to your vehicle.

Automatic collision notification

If the unit fails to connect to the operator, it repeatedly tries until it succeeds.

■ To enable notification

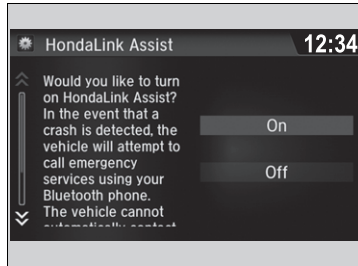

1. Go to the **Phone settings** screen.
 - ▶ **Phone settings screen** P. 379
2. Select the **Phone** tab, then **HondaLink Assist**.
 - ▶ A pop-up menu appears on the screen.
3. Select **On** or **Off**.

▶▶ To enable notification

Setting options:

- **On:** Notification is available.
- **Off:** Disable the feature.

Driving

This chapter discusses driving and refueling.



Before Driving	410
Towing a Trailer	418
Off-Highway Driving Guidelines	430
When Driving	
Starting the Engine	432
Precautions While Driving.....	438
Automatic Transmission	439
Shifting.....	440
ECON Button	442
Intelligent Traction Management.....	443
Cruise Control*.....	445
Front Sensor Camera*.....	448
Road Departure Mitigation (RDM) System*.....	450

Adaptive Cruise Control (ACC)*.....	455
Lane Keeping Assist System (LKAS)*.....	468
Vehicle Stability Assist (VSA®), aka Electronic Stability Control (ESC), System	476
Agile Handling Assist	478
i-VTM4 (Intelligent Variable Torque Management)-4® System*.....	479
TPMS with Tire Fill Assist	480
Tire Pressure Monitoring System (TPMS) - Required Federal Explanation	482
Blind spot information (BSI) System*.....	484
LaneWatch™*.....	486

Braking	
Brake System.....	488
Anti-lock Brake System (ABS).....	490
Brake Assist System	491
Collision Mitigation Braking System™ (CMBS™)*	492
Parking Your Vehicle	
When Stopped	501
Parking Sensor System*	502
Cross Traffic Monitor*	506
Multi-View Rear Camera	510
Refueling	
Fuel Information	512
How to Refuel	513
Fuel Economy and CO₂ Emissions	515

* Not available on all models

Driving Preparation

Check the following items before you start driving.

Exterior Checks

- Make sure there are no obstructions on the windows, door mirrors, exterior lights, or other parts of the vehicle.
 - ▶ Remove any frost, snow, or ice.
 - ▶ Remove any snow on the roof, as this can slip down and obstruct your field of vision while driving. If frozen solid, remove ice once it has softened.
 - ▶ When removing ice from around the wheels, be sure not to damage the wheel or wheel components.
- Make sure the hood is securely closed.
 - ▶ If the hood opens while driving, your front view will be blocked.
- Make sure the tires are in good condition.
 - ▶ Check air pressure, check for damage and excessive wear.
 - ✦ **Checking and Maintaining Tires** P. 545
- Make sure the tailgate is fully closed when it is not being used as an extended pickup bed.
- Make sure the trunk is securely closed and locked.
- Make sure there are no people or objects behind or around the vehicle.
 - ▶ There are blind spots from the inside.

Exterior Checks

NOTICE

When doors are frozen shut, use warm water around the door edges to melt any ice. Do not try to force them open, as this can damage the rubber trim around the doors. When done, wipe dry to avoid further freezing.

Do not pour warm water into the key cylinder. You will be unable to insert the key if the water freezes in the hole.

Heat from the engine and exhaust can ignite flammable materials left under the hood, causing a fire. If you've parked your vehicle for an extended period, inspect and remove any debris that may have collected, such as dried grass and leaves that have fallen or have been carried in for use as a nest by a small animal. Also check under the hood for leftover flammable materials after you or someone else has performed maintenance on your vehicle.

Interior Checks

- Store or secure all items on board properly.
 - ▶ Carrying too much cargo, or improperly storing it, can affect your vehicle's handling, stability, stopping distance, and tires, and make it unsafe.
 - ✦ **Maximum Load Limit** P. 413
- Do not pile items higher than the seat height.
 - ▶ They can block your view and may be thrown forward in the event of sudden braking.
- Do not place anything in the front seat footwells. Make sure to secure the floor mat.
 - ▶ An object or unsecured floor mat can interfere with your brake and accelerator pedal operation while driving.
- If you have any animals on board, do not let them move around in the vehicle.
 - ▶ They may interfere with driving and a crash could occur.
- Securely close and lock all doors.
 - ✦ **Locking/Unlocking the Doors from the Inside** P. 121
- Adjust your seating position properly.
 - ▶ Adjust the head restraint, too.
 - ✦ **Adjusting the Seats** P. 163
 - ✦ **Adjusting the front head restraint positions** P. 168
- Adjust the mirrors and steering wheel properly for your driving.
 - ▶ Adjust them while sitting in the proper driving position.
 - ✦ **Adjusting the Steering Wheel** P. 160
 - ✦ **Adjusting the Mirrors** P. 161

Interior Checks

The headlight aim is set by the factory, and does not need to be adjusted. However, if you regularly carry heavy items in the cargo area or tow a trailer, have the aiming readjusted at a dealer or by a qualified technician.

- Be sure items placed on the floor behind the front seats cannot roll under the seats.
 - ▶ They can interfere with the driver's ability to operate the pedals, the operation of the seats, or the operation of the sensors under the seats.
- Everyone in the vehicle must fasten their seat belt.
 - ▶ **Fastening a Seat Belt** P. 38
- Make sure that the indicators in the instrument panel come on when you start the vehicle, and go off soon after.
 - ▶ Always have a dealer check the vehicle if a problem is indicated.
 - ▶ **Indicators** P. 74

Maximum Load Limit

2WD models

The maximum load for your vehicle is 1,444 lbs (655 kg).

AWD without Moonroof models

The maximum load for your vehicle is 1,543 lbs (700 kg).

AWD with Moonroof models

The maximum load for your vehicle is 1,477 lbs (670 kg).

See the Tire and Loading Information label attached to the driver's doorjamb.

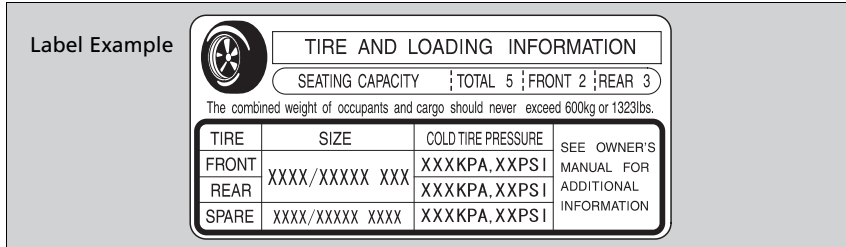

This figure includes the total weight of all occupants, cargo, and accessories, and the tongue load if you are towing a trailer.

Steps for Determining Correct Load Limit -

- (1) Locate the statement "The combined weight of occupants and cargo should never exceed XXX kg or XXX lbs." on your vehicle's placard.
- (2) Determine the combined weight of the driver and passengers that will be riding in your vehicle.
- (3) Subtract the combined weight of the driver and passengers from XXX kg or XXX lbs.

Continued

Maximum Load Limit

⚠ WARNING

Overloading or improper loading can affect handling and stability and cause a crash in which you can be hurt or killed.

Follow all load limits and other loading guidelines in this manual.

- (4) The resulting figure equals the available amount of cargo and luggage load capacity. For example, if the "XXX" amount equals 1,400 lbs. and there will be five 150 lb. passengers in your vehicle, the amount of available cargo and luggage load capacity is 650 lbs. $(1,400 - 750 (5 \times 150) = 650 \text{ lbs.})$
- (5) Determine the combined weight of luggage and cargo being loaded on the vehicle. That weight may not safely exceed the available cargo and luggage load capacity calculated in step 4.
- (6) If your vehicle will be towing a trailer, load from your trailer will be transferred to your vehicle. Consult this manual to determine how this reduces the available cargo and luggage load capacity of your vehicle.

▶▶ Maximum Load Limit

⚠ WARNING

Never let passengers ride in the pickup bed, in the trunk space, or on the bed rails. This could cause very serious injuries or death. No one should ride in any position on your vehicle that is not equipped with seats and seat belts.

Exceeding load limits or improperly loading cargo on the vehicle can cause a crash in which you can be seriously injured or killed.

Load the cargo carefully before starting to drive.

Gross Vehicle Weight Rating (GVWR):

The maximum allowable weight of the vehicle, all occupants, all accessories, all cargo, and the tongue load.

▶▶ **Specifications** P. 600





Gross Axle Weight Rating (GAWR):

The maximum allowable weight of the vehicle axle.

▶▶ **Specifications** P. 600

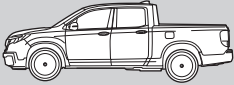
In addition, the total weight of the vehicle, all occupants, accessories, cargo, and trailer tongue load must not exceed the Gross Vehicle Weight Rating (GVWR) or the Gross Axle Weight Rating (GAWR). Both are on a label on the driver's doorjamb.

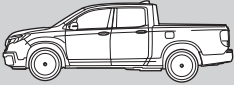
Load Limits Example

Example1		\geq		+	
	<p>Max Load 1,323 lbs (600 kg)</p>		<p>Passenger Weight 150 lbs x 2 = 300 lbs (68 kg x 2 = 136 kg)</p>		<p>Cargo Weight 1,023 lbs (464 kg)</p>
Example2		\geq		+	
	<p>Max Load 1,323 lbs (600 kg)</p>		<p>Passenger Weight 150 lbs x 5 = 750 lbs (68 kg x 5 = 340 kg)</p>		<p>Cargo Weight 573 lbs (260 kg)</p>

Carrying Cargo

Carrying Cargo in the Pickup Bed

Your vehicle can carry a large amount of cargo in the pickup bed.

However, the pickup bed is not intended for carrying passengers.

People who ride in the pickup bed can be very seriously injured or killed in a crash.

- When loading and unloading cargo, make sure all passengers or any objects are clear of the tailgate before opening or closing it. The tailgate should be closed securely before driving when it is not used as the extended pickup bed.
- The maximum allowable loading weight for the trunk is 300 lbs (136 kg). Do not exceed this weight limit, or you may damage the trunk.
- The maximum allowable loading weight on the pickup bed is 1,100 lbs (500 kg). Do not exceed the load limit.

 **Maximum Load Limit** P. 413

- Distribute cargo evenly on the pickup bed. Place the heaviest items on the bottom and as far forward as possible of the rear axle. Tie down and secure all items that could be thrown out of the vehicle during a crash or sudden stop.
- If you stack items higher than the bed sides, tailgate, or back window, secure them with a net or cover.
This will reduce the risk of items being thrown out of the pickup bed during a crash or sudden stop.
- When the tailgate is dropped open, it can be used as an extended pickup bed. The maximum allowable weight on the tailgate while driving is 300 lbs (136 kg). Exceeding this limit could damage the tailgate.
- Carrying heavy cargo in the pickup bed will raise your vehicle's center of gravity. This can affect handling and performance. Drive more slowly and cautiously, and allow extra time and distance for braking.

Carrying Cargo

WARNING

Allowing passengers to ride in the pickup bed or on the tailgate can result in death or serious injury in a crash.

Make sure all passengers ride in a seat and wear a seat belt properly.

WARNING

Never let passengers ride in the pickup bed, in the trunk space, or on the bed rails. This could cause very serious injuries or death. No one should ride in any position on your vehicle that is not equipped with seats and seat belts.

Exceeding load limits or improperly loading cargo on the vehicle can cause a crash in which you can be seriously injured or killed.

Load the cargo carefully before starting to drive.

You can also support motorcycles on the pickup bed floor with the cleats. The floor panel of the pickup bed is designed to hold motorcycle tires. Be sure to tighten motorcycles securely, with an approved tie-down or motorcycle strap, according to the motorcycle maker's instructions.

When carrying motorcycles or any other cargo, do not spill any oil or fluid on the pickup bed. A spilled liquid may damage the pickup bed.

Towing Preparation

Towing Load Limits

Your vehicle can tow a trailer if you carefully observe the load limits, use the proper equipment, and follow the towing guidelines. Check the load limits before driving.

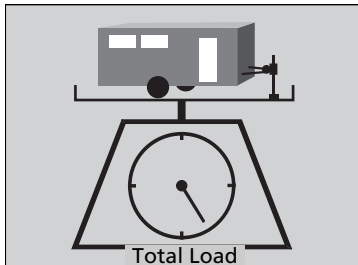

■ Total trailer weight

Do not exceed the maximum allowable weight of the trailer, cargo, and everything in or on it shown in the table.

Towing loads in excess of this can seriously affect vehicle handling and performance and can damage the engine and drivetrain.

Number of occupants	AWD models	2WD models
2	5,000 lbs (2,268 kg)	3,500 lbs (1,587 kg)
4	4,750 lbs (2,154 kg)	3,250 lbs (1,474 kg)
5	4,500 lbs (2,041 kg)	3,000 lbs (1,360 kg)

Each weight limit is calculated based on the following conditions:

- Occupants fill seats from the front of the vehicle to the back
- Each occupant weighs 150 lbs (68 kg)
- Each occupant has 15 lbs (7 kg) of cargo in the cargo area

Any additional weight, cargo or accessories reduce the maximum trailer weight and maximum tongue load.

» Towing Load Limits

⚠ WARNING

Exceeding any load limit or improperly loading your vehicle and trailer can cause a crash in which you can be seriously hurt or killed.

Check the loading of your vehicle and trailer carefully before starting to drive.

Check if all loads are within limits at a public scale. If a public scale is not available, add the estimated weight of your cargo load to the weight of your trailer (as quoted by the manufacturer), and then measure the tongue load with an appropriate scale or tongue gauge or estimate it based on cargo distribution.

Refer to the trailer owner's manual for additional information.

Break-in Period

Avoid towing a trailer during your vehicle's first 600 miles (1,000 km).

Never exceed the gross weight ratings.

Gross weight information

■ **Vehicle Specifications** P. 600

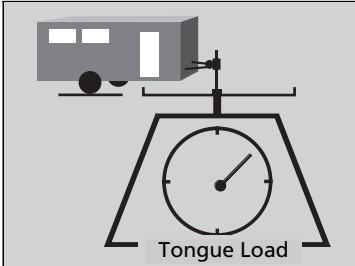

■ Tongue load

The weight of the tongue with a fully loaded trailer on the hitch should be approximately:

Boat trailers: 5 – 15% of the total trailer weight

Other trailers: 10 – 15% of total trailer weight

Number of occupants	AWD models	2WD models
2	600 lbs (272 kg)	420 lbs (190 kg)
4	570 lbs (259 kg)	390 lbs (177 kg)
5	495 lbs (224 kg)	360 lbs (163 kg)

■ To estimate the tongue load

Excessive tongue load reduces front tire traction and steering control. Too little tongue load can make the trailer unstable and cause it to sway.

You can estimate the tongue load by measuring the trailer hitch height from the ground in the following steps:

1. Park the vehicle on level ground.
2. Measure the distance between the ground and the bottom of the trailer hitch.
3. Connect the fully loaded trailer to the hitch.
4. Measure the distance between the ground and the bottom of the trailer hitch again.
5. Subtract the second measurement from the first measurement, then refer to the following table.

If the difference is	AWD models	2WD models
1 inches (2.5 cm)	150 lbs (68 kg)	
1 1/2 inches (3.8 cm)	250 lbs (114 kg)	
2 inches (5.1 cm)	350 lbs (159 kg)	
2 3/8 inches (6.0 cm)	450 lbs (205 kg)	—
2 5/8 inches (6.7 cm)	500 lbs (227 kg)	—

If the difference becomes more than indicated in the table, distribute the load or remove cargo as needed.

■ How to weigh the trailer loads using the public scale

Check each weight in the order indicated as shown.

Refer to the table on the right for each weight's limit except for the tongue load.

📌 Tongue load P. 419

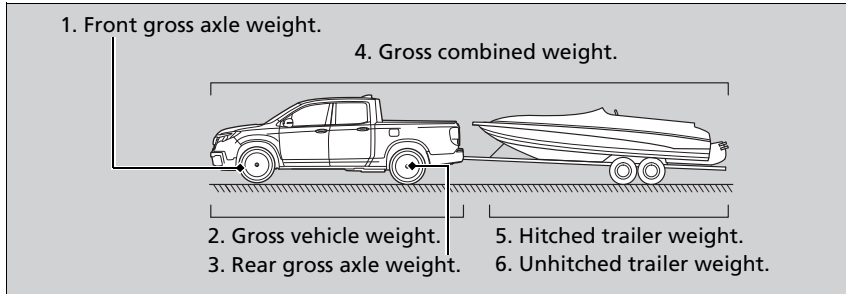

- If you cannot weigh the rear axle, subtract 1 from 2.
- The maximum gross combined weight (4) decreases by 2% for every 1,000 feet (305 meters) of elevation.
- To calculate the tongue load, subtract 5 from 6.
- Refer to the trailer owner's manual for additional information.

📌 How to weigh the trailer loads using the public scale

Fully load the vehicle and trailer. An attendant who watches the scale is needed as all occupants should stay in the vehicle.

Weight limit for	2WD models	AWD models
Front gross axle	2,734 lbs (1,240 kg)	2,855 lbs (1,295 kg)
Gross vehicle	5,545 lbs (2,515 kg)	5,842 lbs (2,650 kg)
Rear gross axle	2,921 lbs (1,325 kg)	3,097 lbs (1,405 kg)
Gross combined	8,025 lbs (3,640 kg)	9,755 lbs (4,425 kg)

If a public scale is not available, add the estimated weight of your cargo load to the weight of your trailer (as quoted by the manufacturer), and then measure the tongue load with an appropriate scale or tongue gauge or estimate it based on cargo distribution.

Models with AWD

Towing Equipment and Accessories

Towing generally requires a variety of supplemental equipment. To ensure the best quality, we recommend that you purchase Honda equipment whenever possible.

Your vehicle has a class 3 trailer hitch as standard equipment. The jumper harness and trailer brake fuse are stored in the glove box.

➤ **Trailer brakes** P. 423

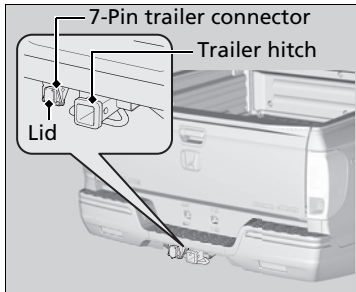

Open the lid of the socket (located next to the trailer hitch) to expose the 7-pin trailer connector.

Hitches

Read the trailer manufacturer's instructions, and select the appropriate draw bar for the height of the trailer you will be towing.

Towing Equipment and Accessories

Make sure that all equipment is properly installed and maintained, and that it meets federal, state, province/territory, and local regulations.

Consult your trailer maker for proper installation and setup of the equipment.

Improper installation and setup can affect the handling, stability, and braking performance of your vehicle.

Consult your trailer sales or rental agency if any other items are recommended or required for your towing situation.

The lighting and wiring of trailers can vary by type and brand. If a connector is required, it should only be installed by a qualified technician.

Trailer packages and products:

- Ball mount, hitch plug, hitch pin etc.
- Wiring harness kit
- Trailer hitch kit (jumper harness included)

Are available at a dealer.

■ Weight distribution hitches

Your vehicle is designed to tow without the need for a load distributing hitch. If you wish to use one, please consult your trailer maker for proper installation and set-up. Improper set-up could degrade the handling, stability, and braking performance of your vehicle.

■ Safety chains

Always use safety chains when you tow a trailer. Leave enough slack to allow the trailer to turn corners easily, but do not allow the chains to drag on the ground.

■ Trailer brakes

Recommended for any trailer with a total weight of 1,000 lbs (450 kg) or more:

There are two common types of trailer brakes: surge and electric. Surge brakes are common for boat trailers, since the brakes will get wet.

If you choose electric brakes, be sure they are electronically actuated. Do not attempt to attach trailer brakes to your vehicle's hydraulic system, as it will lower braking effectiveness and create a potential hazard.

The 4-pin gray connector installed in your vehicle has all of the circuits required to install most electric trailer brake controllers.

▶▶ Trailer brakes

The 4-pin gray connector is located under the instrument panel near the top of the parking brake pedal.

Continued

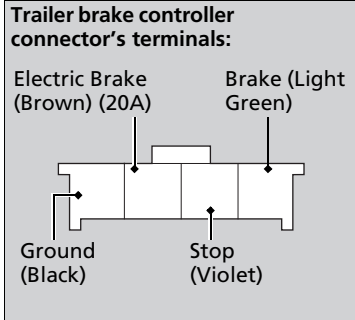

Have a qualified mechanic install your trailer brake controller following the trailer brake controller manufacturer's instructions. Failure to properly install the trailer brake controller may increase the distance it takes for you to stop your vehicle when towing a trailer.

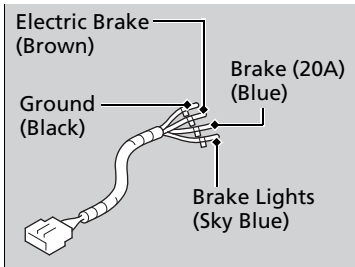

The trailer hitch harness is used to install the controller for the electric trailer brakes. Insert the trailer brake fuse into the engine compartment sub fuse box.

➤ **Engine Compartment Fuse Box Type B**

P. 591

■ Trailer light

Trailer lights and equipment must comply with federal, state, province/territory, and local regulations. Check with your local trailer sales or rental agency for the requirements in the area where you plan to tow.

(For 2WD Vehicles Only):

Pins' wiring color codes and their purposes:

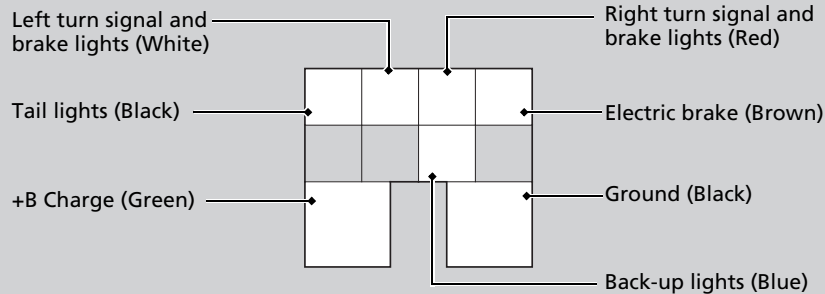

We recommend that you have a dealer install a Honda wiring harness and converter. They are designed for your vehicle.

✉ Trailer light

The trailer lighting connector is located behind the trailer hitch. Even if you are planning to use the non-Honda trailer lighting harness and converter, ask a dealer for the correct connector and pins.

The 7-pin trailer connector is needed for your trailer lights. When inserting the connector to the socket, check if the connector and the socket are free of dirt, moisture, or other foreign material.

(For Vehicles Equipped with Trailer Hitch Harness Only):

Pins' wiring color codes and their purposes:

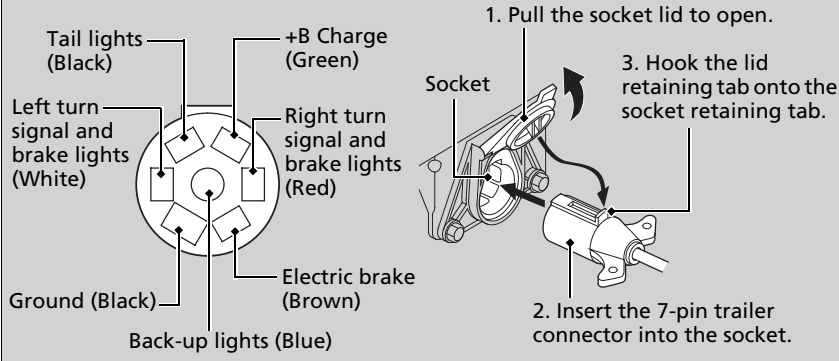

The lighting and wiring of trailers can vary by type and brand. If a connector is required, it should only be installed by a qualified technician.

■ **Sway control**

This device can be used if your trailer tends to sway. Your trailer maker can tell you what kind of sway control you need and how to install it. Improper installation could degrade the handling and stability of your vehicle.

■ **Trailer mirrors**

Many states, provinces and territories require special exterior mirrors when towing a trailer. Install special mirrors whenever you cannot clearly see behind you, or if the trailer creates a blind spot.

Trailer Stability Assist

Helps to stabilize the vehicle and trailer when the trailer severely sways.

■ How trailer stability assist works

When the vehicle and trailer become unstable while driving, trailer stability assist determines the cause. If the trailer oscillation is detected as the cause, and the swaying increases, the system applies the brakes or controls engine output to reduce vehicle speed.

Both the vehicle and trailer brake lights come on automatically if you brake to reduce vehicle speed.

▶ Trailer Stability Assist

Trailer stability assist is not a function that prevents the vehicle and trailer from swaying. Avoid high speeds, abrupt steering, improper trailer load, and sudden braking to keep the trailer from swaying. When swayed too severely, the system becomes ineffective, and you may lose control of your vehicle, causing the trailer to roll over or get damaged.

▶ **Driving Safely with a Trailer** P. 428

Trailer towing sway is caused by:

- Crosswinds
- Improper towbar down load
- Excessive Speed

The VSA® system indicator blinks during the trailer stability assist operation.

▶ **VSA® Operation** P. 476

Driving Safely with a Trailer

■ Things You Need To Know Before Towing a Trailer

- Have the trailer properly serviced and keep it in good condition.
- Make sure that all the weights and load in the vehicle and trailer are within limits.
 - ✎ **Towing Load Limits** P. 418
- Securely attach the hitch, safety chains, and other necessary parts to the trailer.
- Securely store all the items in and on the trailer so that they do not shift while driving.
- Check if the lights and brakes on the trailer are working properly.
- Check the pressures of the trailer tires, including the spare.

■ Towing Speeds and Gears

- Drive slower than normal.
- Obey posted speed limits for vehicles with trailers.
- Use the **D** position when towing a trailer on level roads.

■ Turning and Braking

- Turn more slowly and with a wider turning arc than normal.
- Allow more time and distance for braking.
- Do not brake or turn suddenly.

►► Driving Safely with a Trailer

Operating speed when towing a trailer must not exceed 62 mph (100 km/h).

Parking

In addition to the normal precautions, place wheel chocks at each of the trailer's tires.

When towing a trailer, we recommend that you carry a full-size spare wheel and tire for both your vehicle and trailer. If you use the compact spare tire that came with your vehicle, it could adversely affect vehicle handling.

Remember to unhitch the trailer before changing a flat tire. Ask the trailer sales or rental agency where and how to store the trailer's spare tire.

►► Towing Speeds and Gears

When towing a fixed-sided trailer (e.g., camper), do not exceed 55 mph (88 km/h).
At higher speeds, the trailer may sway or affect vehicle handling.

Driving in Hilly Terrain

- Monitor your temperature gauge. If it nears the **H** mark, turn off the heating and cooling system*/climate control system* and reduce speed. Pull to the side of the road safely to cool down the engine if necessary.
- Shift to the **D4** position if the transmission shifts frequently.

Retrieving a Boat

If the vehicle tires slip when retrieving a boat from the water, keep the transmission in **D**. This prevents damage to the transmission.

Towing Your Vehicle

Your vehicle is not designed to be towed behind a motorhome. If your vehicle needs to be towed in an emergency, refer to the emergency towing information.

📄 **Emergency Towing** P. 594

General Information

Your vehicle has been designed primarily for use on pavement, however, its higher ground clearance allows you to occasionally travel on unpaved roads. It is not designed for trail-blazing, or other challenging off-road activities.

If you decide to drive on unpaved roads, you will find that it requires somewhat different driving skills and that your vehicle will handle somewhat differently than it does on pavement. Pay attention to the precautions and tips in this section, and get acquainted with your vehicle before leaving the pavement.

Important Safety Precautions

To avoid loss of control or rollover, be sure to follow all precautions and recommendations:

- Be sure to store cargo properly and do not exceed your cargo load limits.
 - **Maximum Load Limit** P. 413
- Whenever you drive, make sure you and your passengers always wear seat belts.
- Keep your speed low, and never go faster than the conditions allow.
- It's up to you to continually assess the situation and drive within the limits.

➤ Off-Highway Driving Guidelines

WARNING

Improperly operating this vehicle on or off-pavement can cause a crash or rollover in which you and your passengers could be seriously injured or killed.

- Follow all instructions and guidelines in this owner's manual.
- Keep your speed low, and don't drive faster than conditions permit.

Failure to operate your vehicle correctly might result in a crash or a rollover.

- **Important Handling Information** P. 32
- **Precautions While Driving** P. 438

Spinning the tires excessively can also damage the Intelligent VTm4 (i-VTM4) system.

Avoiding Trouble

- **Check Out Your Vehicle** before you leave the pavement and make sure that all scheduled maintenance has been completed. Pay special attention to the condition of the tires, and check the tire pressures.
- **Remember** the route you choose presents limits (too steep or bumpy), you have limits (driving skill and comfort), and your vehicle has limits (traction, stability, and power). Failing to recognize these limits will likely put you and your passengers in a hazardous situation.
- **Accelerating and Braking** should be done slowly and gradually. Trying to start or stop too fast can cause a loss of traction and you could lose control.
- **Avoiding Obstacles and Debris** in the road reduces the likelihood of a rollover or damage to your suspension or other components.
- **Driving on Slopes** increases your risk of a rollover, particularly if you attempt to drive across a slope that is too steep. Going straight up or down a slope is usually the safest. If you can't clearly see all conditions or obstacles on a slope, walk it before you drive it. If there is any doubt whether you can safely pass, don't try it. Find another route. If you get stuck when climbing, do not try to turn around. Back down slowly following the same route you took up the hill.
- **Crossing a Stream** - Avoid driving through deep water. If you encounter water in your route (a small stream or large puddle, for example), evaluate it carefully before going ahead. Make sure it is shallow, flowing slowly, and has firm ground underneath. If you are not sure of the depth or the ground, turn around and find another route. Driving through deep water can also damage your vehicle. The water can get into the transmission and differential, diluting the lubricant and causing an eventual failure. It can also wash the grease out of the wheel bearings.
- **If You Get Stuck**, carefully go in the direction that you think will get you unstuck. Do not spin the tires as this will only make things worse and could damage the transmission. If you are unable to free yourself, your vehicle will need to be towed. Front and rear tow hooks are provided for this purpose.

Starting the Engine

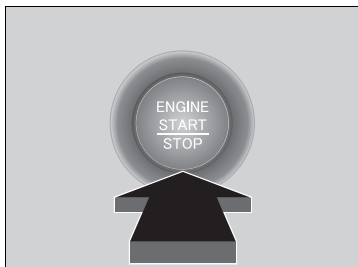
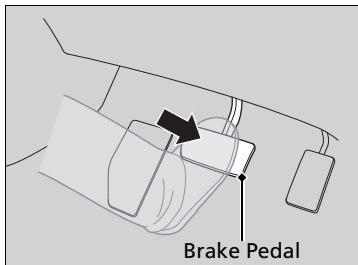
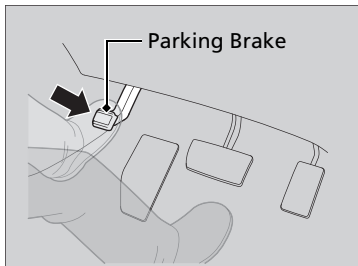

1. Make sure the parking brake is applied.

2. Check that the shift lever is in **[P]**, then depress the brake pedal.

▶ Although it is possible to start the vehicle in **[N]**, it is safer to start it in **[P]**.

3. Press the **ENGINE START/STOP** button without depressing the accelerator pedal. The engine will crank until it starts.

Starting the Engine

Keep your foot firmly on the brake pedal when starting the engine.

The engine is harder to start in cold weather and in thinner air found at altitudes above 8,000 feet (2,400 meters).

When starting the engine in cold weather, turn off all electrical accessories such as the lights, heating and cooling system*/climate control system*, and rear defogger in order to reduce battery drain.

If you live in a region where winter is extremely cold, an engine block heater will improve starting and warming of the engine. Consult a dealer for details.

Bring the smart entry remote close to the **ENGINE START/STOP** button if the battery in the smart entry remote is weak.

▶ **If the Smart Entry Remote Battery is Weak**
P. 577

The engine may not start if the smart entry remote is subjected to strong radio waves.

Do not hold the **ENGINE START/STOP** button to start the engine.

If the engine does not start, wait at least 30 seconds before trying again.

■ Stopping the Engine

You can turn the engine off when the vehicle is completely stopped.

1. Shift to **P**.
2. Press the **ENGINE START/STOP** button with your foot on the brake pedal.

▶▶ Starting the Engine

The immobilizer system protects your vehicle from theft.

If an improperly coded device is used, the engine's fuel system is disabled.

▶ **Immobilizer System** P. 133

Continued

Remote Engine Start*

You can remotely start the engine using the smart entry remote.

Remote Engine Start*

WARNING



Engine exhaust contains toxic carbon monoxide.

Breathing carbon monoxide can kill you or cause unconsciousness.

Never use the remote engine starter when the vehicle is parked in a garage or other area with limited ventilation.

If there are buildings and obstacles between your vehicle and the remote, the range will be reduced. This distance may vary by external electrical interference.



The engine may not start by the remote engine start if:

- You have disabled a remote engine start setting using the audio/information screen.
- You do not press and hold the  button within 5 seconds after the  button is pressed.
- The power mode is not in VEHICLE OFF (LOCK).
- The shift lever is in a position other than .
- The hood is open, or any door or the trunk is unlocked.
- You have already used the remote twice to start the engine.
- Another registered smart entry remote is in the vehicle.

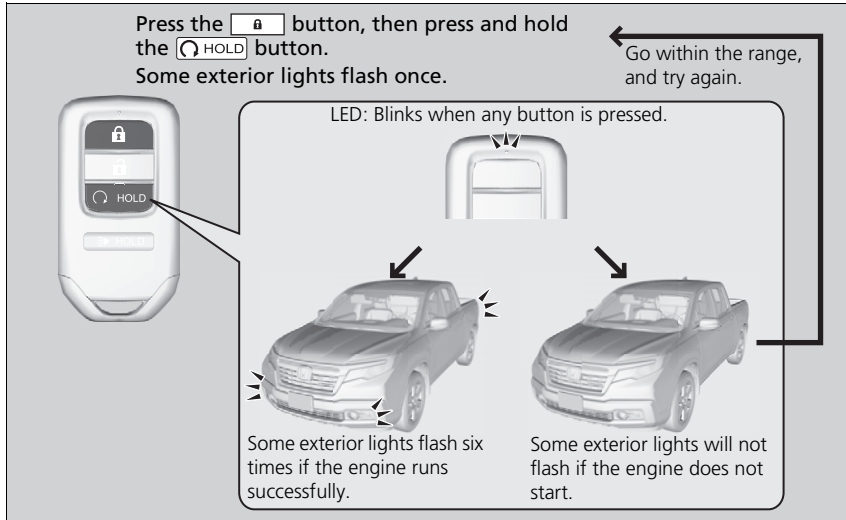
■ To start the engine



The engine runs for up to 10 minutes without you starting the vehicle.

To extend the run time for another 10 minutes during the first run, press the  button, then press and hold the  button.

- ▶ Some exterior lights come back on three times, twice, if a 10-minute extension request was transmitted successfully.

⊞ Remote Engine Start*

- There is any antenna failure.
- Door is unlocked with the built-in key.
- The engine oil pressure is low.
- The engine coolant temperature is extremely high.
- The telematics unit malfunctions.
- The security system alarm is not set.

The engine may stop while it is running if:

- You do not start the vehicle within 10 minutes of starting the engine with the smart entry remote.
- The engine is stopped by using the smart entry remote.
- There is any antenna failure.
- The security system alarm is not set.
- Door is unlocked with the built-in key.
- The hood is open, or any door, or the trunk is unlocked.
- You press the shift lever release button.
- The telematics unit malfunction.
- The engine coolant temperature is extremely high.
- The battery is low.
- The engine oil pressure is low.
- The Malfunction Indicator Lamp (MIL) comes on if there is a problem with the emissions control systems.

* Not available on all models

■ To stop the engine

Press and hold the  **HOLD** button for one second.

Go within the range, and try again.

Some exterior lights will not flash when the remote is out of the keyless access system range. The engine will not stop.

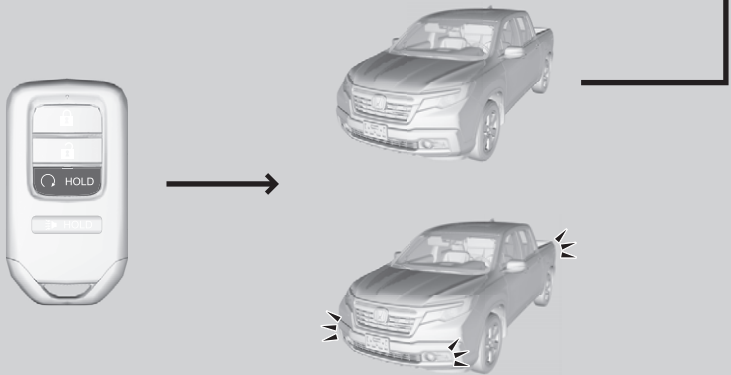

Some exterior lights flash once if the engine stops successfully.

▣ Remote Engine Start *

While the engine is running, the vehicle will automatically precondition inside the vehicle.

When it is warm outside:

- The heating and cooling system*/climate control system* is activated in recirculation mode.
- The seat ventilation* is activated.

When it is cold outside:

- The defroster is activated at a moderately warm temperature.
- The rear defogger and door mirror heaters* are activated.
- The seat heaters* and heated steering wheel* are activated.

▣ **Heated Steering Wheel*** P. 180

▣ **Front Seat Heaters and Seat Ventilation*** P. 182, 183

Starting to Drive

When the engine was started using the smart entry remote

1. Depress the brake pedal and press the **ENGINE START/STOP** button simultaneously.

When the engine was started in any case

2. Keeping your right foot on the brake pedal, release the parking brake. Check that the parking brake indicator has gone off.
 ➤ **Parking Brake** P. 488
3. Put the shift lever in **[D]**. Select **[R]** when reversing.
4. Gradually release the brake pedal and gently depress the accelerator pedal to pull away.

■ Hill start assist system

Hill start assist keeps the brake engaged briefly to help prevent the vehicle from rolling on inclines as you move your foot from the brake pedal to the accelerator.

Move the shift lever to **[D]**, **[D4]**, or **[L]** when facing uphill, or **[R]** when facing downhill, then release the brake pedal.

The brakes remain engaged briefly as you release the brake pedal.

▶▶ Starting to Drive

When the engine was started using the smart entry remote

The engine stops when the shift lever is moved out of **[P]** before the **ENGINE START/STOP** button is pressed. Follow the step 1 when starting to drive.

▶▶ Hill start assist system

Hill start assist may not prevent the vehicle from rolling downhill on a very steep or slippery slope, and will not operate on small inclines.

Hill start assist is not a replacement for the parking brake.

Precautions While Driving

Driving Guidelines for Your Utility Vehicle

Utility vehicles have a significantly higher rollover rate than other types of vehicles. To prevent rollovers or loss of control:

- Take corners at slower speeds than you would with a passenger vehicle.
- Avoid sharp turns and abrupt maneuvers whenever possible.
- Do not modify your vehicle in any way that you would raise the center of gravity.
- Do not carry heavy cargo on the roof.

Never carry more than 165 lbs (75 kg) of cargo on the roof rack (Honda accessory).

In Rain

Avoid driving in deep water and on flooded roads. This can damage the engine, driveline, or cause electrical component failure.

Other Precautions

If there is a strong impact with something under the vehicle, stop in a safe location. Check the underside of the vehicle for damage or any fluid leaks.

Precautions While Driving

NOTICE

Do not change the shift lever while pressing the accelerator pedal. You could damage the transmission.

NOTICE

If you repeatedly turn the steering wheel at an extremely low speed, or hold the steering wheel in the full left or right position for a while, the system heats up. The system goes into a protective mode, and limits its performance. The steering wheel becomes harder and harder to operate. Once the system cools down, the EPS system is restored. Repeated operation under these conditions can eventually damage the system.

If the power mode is set to ACCESSORY while driving, the engine will shut down and all steering and brake power assist functions will stop, making it difficult to control the vehicle.

Do not put the shift lever in **[N]**, as you will lose engine braking (and acceleration) performance.

During the first 600 miles (1,000 km) of operation, avoid sudden acceleration or full throttle operation so as not to damage the engine or powertrain.

Avoid hard braking for the first 200 miles (300 km). You should also follow this when the brake pads are replaced.

Automatic Transmission

■ Creeping

The engine runs at a higher idle speed and creeping increases. Keep the brake pedal firmly depressed when stopped.

■ Kickdown

Quickly depressing the accelerator pedal while driving uphill may cause the transmission to drop to a lower gear, unexpectedly increasing vehicle speed. Depress the accelerator pedal carefully, especially on slippery roads and curves.

📖 Driving Guidelines for Your Utility Vehicle

Failure to operate your vehicle correctly might result in a crash or a rollover.

📖 **Important Handling Information** P. 32

📖 **Precautions While Driving** P. 438

Shifting

Change the shift position in accordance with your driving needs.

■ Shift lever positions

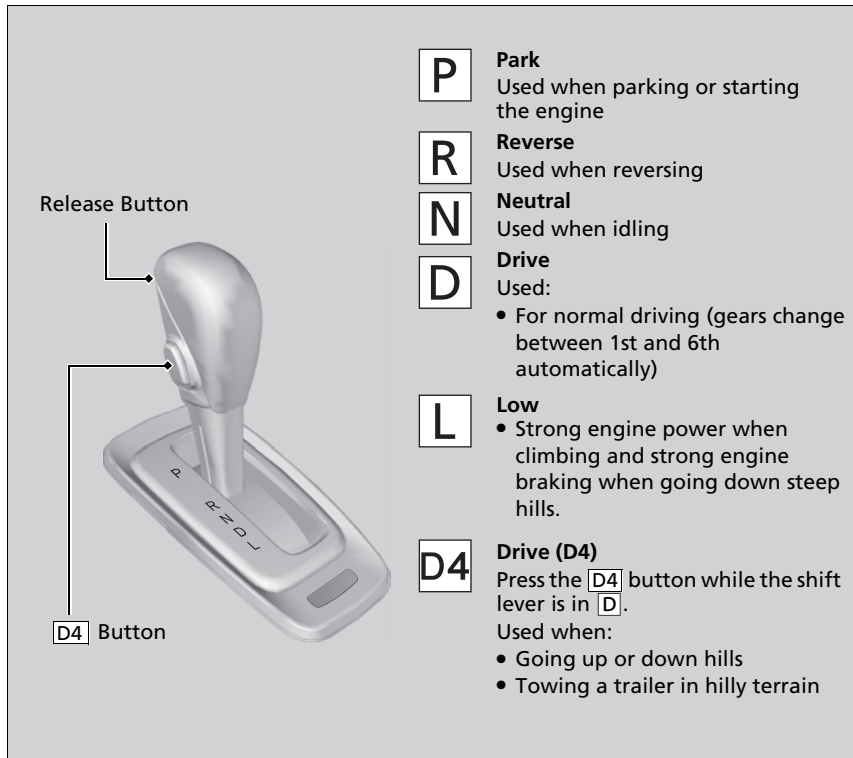

P **Park**
Used when parking or starting the engine

R **Reverse**
Used when reversing

N **Neutral**
Used when idling

D **Drive**
Used:
• For normal driving (gears change between 1st and 6th automatically)

L **Low**
• Strong engine power when climbing and strong engine braking when going down steep hills.

D4 **Drive (D4)**
Press the **D4** button while the shift lever is in **D**.
Used when:
• Going up or down hills
• Towing a trailer in hilly terrain

▶▶ Shifting

You cannot change the power mode from ON to VEHICLE OFF (LOCK) unless the shift lever is in **P**.

The vehicle may move forward very slightly even in **N** while the engine is cold. Depress the brake pedal firmly and, when necessary, apply the parking brake.

When shifting gears in extremely low temperatures (-22°F/-30°C), there may be a short delay before the shift indicated in the display. Always confirm you are in the correct gear before driving.

Shift Lever Operation

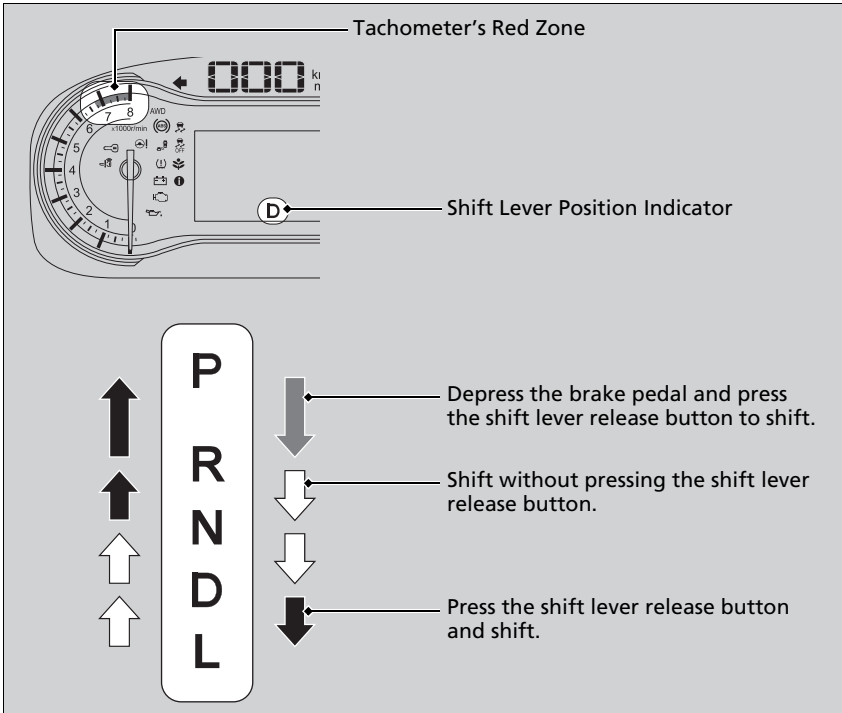

Shift Lever Operation

NOTICE

When you change the shift lever from **D** to **R** and vice versa, come to a complete stop and keep the brake pedal depressed. Operating the shift lever before the vehicle has come to a complete standstill can damage the transmission.

Use the shift lever position indicator to check the lever position before pulling away.

Whichever position the shift lever is in when driving, a blinking transmission indicator indicates a transmission problem. Avoid sudden acceleration and have the transmission checked by a dealer as soon as possible.

The fuel supply may be cut off if you drive at engine speeds in or over the tachometer's red zone (engine speed limit). If this happens, you may experience a slight jolt.

It may not be possible to operate the shift lever if the brake pedal is applied while the shift lever release button is held down. Depress the brake pedal first.

ECON Button

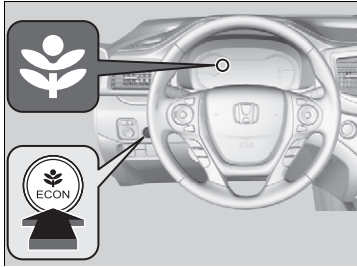

The **ECON** button turns the ECON mode on and off.

The ECON mode helps you improve your fuel economy by adjusting the performance of the engine, air conditioning system, and cruise control.

▶▶ ECON Button

While in ECON mode, the climate control system * has greater temperature fluctuation.

Intelligent Traction Management

The Intelligent Traction Management optimizes vehicle performance to help you drive on various surfaces. The system has available modes to select from: **Normal**, **Snow**, **Mud***, and **Sand***.

Press the mode button to select the appropriate mode. The mode you select appears on the multi-information display. When the vehicle is turned off and restarted, Intelligent Traction Management mode will revert to Normal.

Intelligent Traction Management

Refer to the Off-Highway Driving section for driving tips and safety precautions.

➤ **Off-Highway Driving Guidelines** P. 430

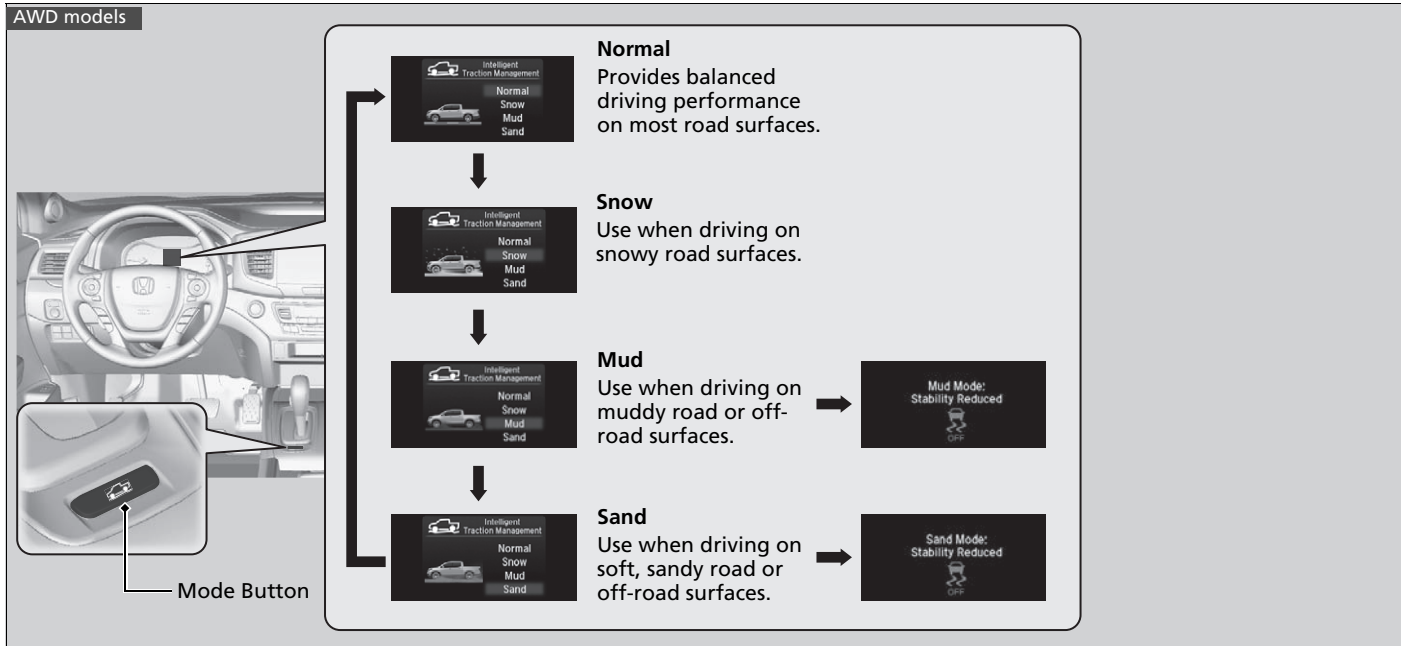

* Not available on all models

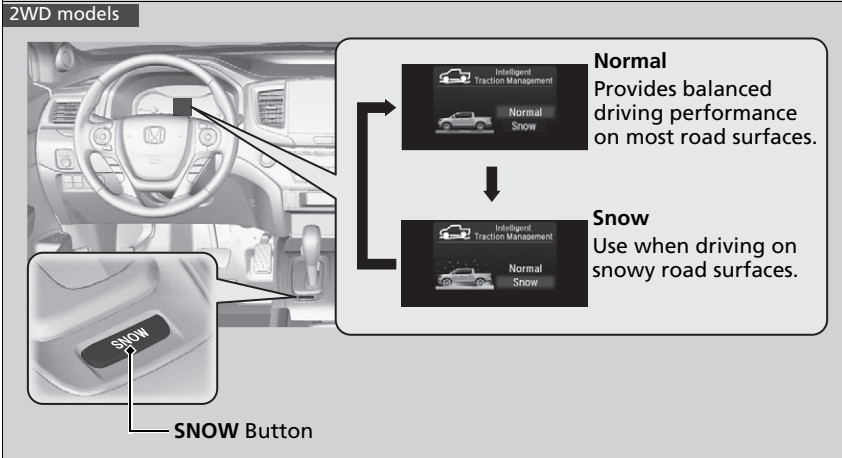

Cruise Control*

Maintains a constant vehicle speed without having to keep your foot on the accelerator. Use cruise control on freeways or open roads where you can travel at a constant speed with little acceleration or deceleration.

When to use

- **Vehicle speed for cruise control:**
Desired speed in a range above roughly 25 mph (40 km/h) ~

Always keep sufficient distance between you and the vehicle in front of you.

- **Shift positions for cruise control:**
In **D**



How to use

CRUISE MAIN is on in the instrument panel.
Cruise control is ready to use.



- Press the **CRUISE** button on the steering wheel.

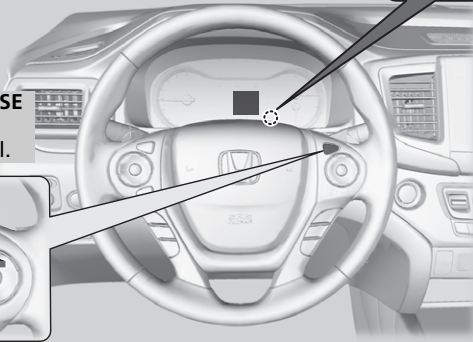

⚠ Cruise Control*

⚠ WARNING

Improper use of the cruise control can lead to a crash.

Use the cruise control only when traveling on open highways in good weather.

It may not be possible to maintain a constant speed when driving uphill or downhill.

When not using cruise control:

Turn off cruise control by pressing the **CRUISE** button.

While in the ECON mode, it may take relatively more time to accelerate to maintain the set speed.

Cruise control is not available when the Intelligent Traction Management Snow, Mud* or Sand* modes are in operation.

* Not available on all models

■ To Set the Vehicle Speed

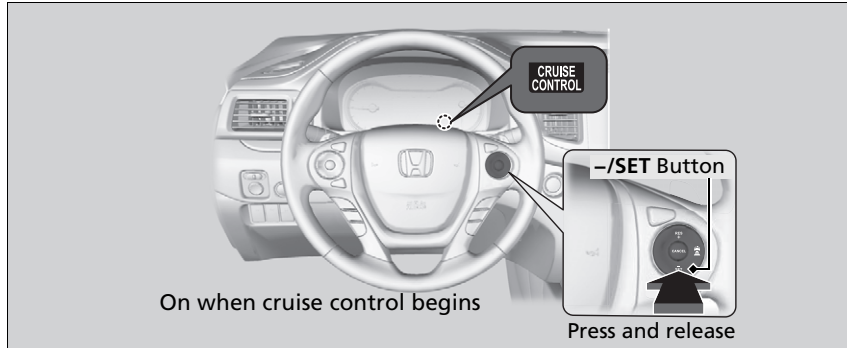

Take your foot off the pedal and press the **-/SET** button when you reach the desired speed.

The moment you release the **-/SET** button, the set speed is fixed, and cruise control begins. The **CRUISE CONTROL** indicator comes on.

■ To Adjust the Vehicle Speed

Increase or decrease the vehicle speed using the **RES/+** or **-/SET** buttons on the steering wheel.

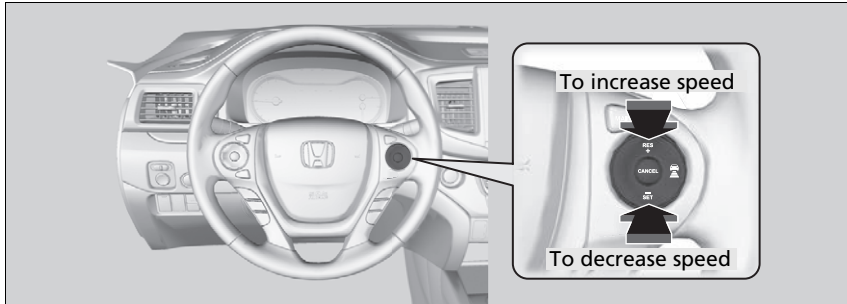

- Each time you press the button, the vehicle speed is increased or decreased by about 1 mph (1.6 km/h).
- If you keep the button pressed, the vehicle speed increases or decreases until you release it. This speed is then set.

■ To Cancel

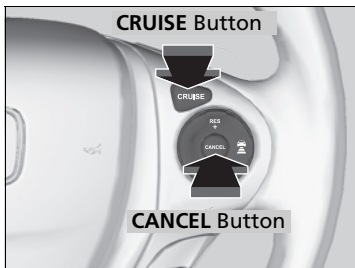

To cancel cruise control, do any of the following:

- Press the **CRUISE** button.
- Press the **CANCEL** button.
- Depress the brake pedal.

The **CRUISE CONTROL** indicator goes off.

☒ To Adjust the Vehicle Speed

You can set the vehicle speed using the **RES/+** or **-/SET** button on the steering wheel when adjusting the speed with the accelerator and brake pedals.

☒ To Cancel

Resuming the prior set speed:

After cruise control has been canceled, you can still resume the prior set speed by pressing the **RES/+** button while driving at a speed of at least 25 mph (40 km/h) or more.

You cannot set or resume in the following situations:

- When vehicle speed is less than 25 mph (40 km/h)
- When the **CRUISE** button is turned off

At vehicle speeds of 22 mph (35 km/h) or less, cruise control is canceled automatically.

Front Sensor Camera*

The camera, used in systems such as LKAS, RDM, ACC, and CMBS™, is designed to detect an object that triggers any of the systems to operate its functions.

■ Camera Location and Handling Tips

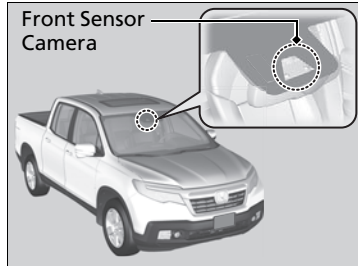

This camera is located behind the rearview mirror.

To help reduce the likelihood that high interior temperatures will cause the camera's sensing system to shut off, when parking, find a shady area or face the front of the vehicle away from the sun. If you use a reflective sun shade, do not allow it to cover the camera housing. Covering the camera can concentrate heat on it.

⚠ Front Sensor Camera*

Never apply a film or attach any objects to windshield, the hood, or the front grill that could obstruct the camera's field of vision and cause the system to operate abnormally. Scratches, nicks, and other damage to the windshield within the camera's field of vision can cause the system to operate abnormally. If this occurs, we recommend that you replace the windshield with a genuine Honda replacement windshield. Making even minor repairs within the camera's field of vision or installing an aftermarket replacement windshield may also cause the system to operate abnormally. After replacing the windshield, have a dealer recalibrate the camera. Proper calibration of the camera is necessary for the system to operate properly.

Do not place an object on the top of the instrument panel. It may reflect onto the windshield and prevent the system from detecting lane lines properly.

▶ Front Sensor Camera*

If the **Some Driver Assist Systems Cannot**

Operate:  message appears:

- Use the heating and cooling system*/climate control system* to cool down the interior and, if necessary, also use defroster mode with the air flow directed towards the camera.
- Start driving the vehicle to lower the windshield temperature, which cools down the area around the camera.

If the **Some Driver Assist Systems Cannot**

Operate:  message appears:

- Park your vehicle in a safe place, and clean the windshield. If the message does not disappear after you have cleaned the windshield and driven for a while, have your vehicle checked by a dealer.

Road Departure Mitigation (RDM) System*

Alerts and helps to assist you when the system detects a possibility of your vehicle unintentionally crossing over detected lane markings and/or leaving the roadway altogether.

How the System Works

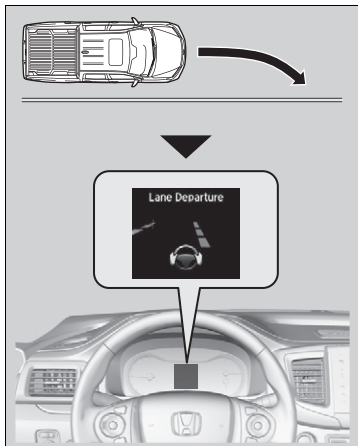

The front camera behind the rearview mirror monitors left and right lane markings (in white or yellow). If your vehicle is getting too close to detected lane markings without a turn signal activated, the system, in addition to a visual alert, applies steering torque and alerts you with rapid vibrations on the steering wheel, to help you remain within the detected lane.

As a visual alert, the **Lane Departure** message appears on the multi-information display.

If the system determines that its steering input is insufficient to keep your vehicle on the roadway, it may apply braking.

- ▶ Braking is applied only when the lane markings are solid continuous lines.

The system cancels assisting operations when you turn the steering wheel to avoid crossing over detected lane markings.

If the system operates several times without detecting driver response, the system beeps to alert you.

⚠ Road Departure Mitigation (RDM) System*

Important Safety Reminder

Like all assistance systems, the RDM system has limitations.

Over-reliance on the RDM system may result in a collision. It is always your responsibility to keep the vehicle within your driving lane.

The RDM system only alerts you when lane drift is detected without a turn signal in use. The RDM system may not detect all lane markings or lane or roadway departures; accuracy will vary based on weather, speed and lane marker condition. It is always your responsibility to safely operate the vehicle and avoid collisions.

You can read about handling information for the camera equipped with this system.

▶ **Front Sensor Camera*** P. 448

The RDM system may not work properly or may work improperly under the certain conditions:

▶ **RDM Conditions and Limitations** P. 453

There are times when you may not notice RDM functions due to your operation of the vehicle, or road surface conditions.

How the System Activates

The system becomes ready to start searching for lane markings when all the following conditions are met:

- The vehicle is traveling between about 45 and 90 mph (72 and 145 km/h).
- The vehicle is on a straight or slightly curved road.
- The turn signals are off.
- The brake pedal is not depressed.
- The wipers are not in continuous operation.
- The system makes a determination that the driver is not actively accelerating, braking or steering.

How the System Activates

The RDM system may automatically shut off and the  indicator comes and stays on.

➤ **Indicators** P. 84

The RDM system function can be impacted when the vehicle is:

- Not driven within a traffic lane.
- Driven on the inside edge of a curve, or outside of a lane.
- Driven in a narrow lane.

■ RDM On and Off

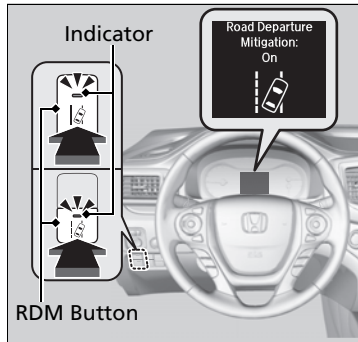

Press the RDM button to turn the system on and off.

- ▶ The indicator in the button comes on and the message appears on the multi-information display when the system is on.

▣ RDM On and Off

When you have selected **Warning Only** from the customized options using the audio/information screen, the system does not operate the steering wheel and braking.

RDM Conditions and Limitations

The system may not properly detect lane markings and the position of your vehicle under certain conditions. Some examples of these conditions are listed below.

■ Environmental conditions

- Driving in bad weather (rain, fog, snow, etc.).
- Sudden changes between light and dark, such as an entrance or exit of a tunnel.
- There is little contrast between lane lines and the roadway surface.
- Driving into low sunlight (e.g., at dawn or dusk).
- Strong light is reflected onto the roadway.
- Driving in the shadows of trees, buildings, etc.
- Shadows of adjacent objects are parallel to lane markings.
- Roadway objects or structures are misinterpreted as lane markers.
- Reflections on the interior of the front windshield.

■ Roadway conditions

- Driving on a snowy or wet roadway (obscured lane marking, vehicle tracks, reflected lights, road spray, high contrast).
- Driving on a road with temporary lane markings.
- Faint, multiple, or varied lane markings are visible on the roadway due to road repairs or old lane markings.
- The roadway has merging, split, or crossing lines (e.g., such as at an intersection or crosswalk).
- The lane markings are extremely narrow, wide, or changing.
- The vehicle in front of you is driving near the lane lines.
- The road is hilly or the vehicle is approaching the crest of a hill.
- Driving on rough or unpaved roads, or over bumpy surfaces.
- When objects on the road (curb, guard rail, pylons, etc.) are recognized as white lines (or yellow lines).
- When driving on roads with double lines.

■ Vehicle conditions

- Headlight lenses are dirty or the headlights are not properly adjusted.
- The outside of the windshield is streaked or blocked by dirt, mud, leaves, wet snow, etc.
- The inside of the windshield is fogged.
- The camera temperature gets too hot.
- An abnormal tire or wheel condition (wrong sized, varied size or construction, improperly inflated, compact spare tire, etc.).
- The vehicle is tilted due to a heavy load or suspension modifications.
- When tire chains are installed.

Adaptive Cruise Control (ACC)*

Helps maintain a constant vehicle speed and a set following interval behind a vehicle detected ahead of yours, without you having to keep your foot on the brake or the accelerator.

When to use

The camera is located behind the rearview mirror.

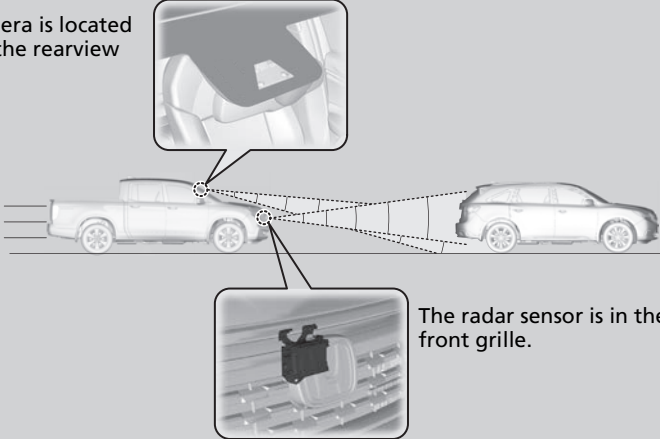

The radar sensor is in the front grille.

- Vehicle speed for adaptive cruise control: Desired speed in a range above roughly 25 mph (40 km/h) ~
- Shift positions for adaptive cruise control: In **D**

Adaptive Cruise Control (ACC)*

⚠ WARNING

Improper use of ACC can lead to a crash.

Use ACC only when traveling on open highways in good weather.

⚠ WARNING

ACC has limited braking capability.

When your vehicle speed drops below 22 mph, ACC will automatically cancel and no longer will apply your vehicle's brakes.

Always be prepared to apply the brake pedal when conditions require.

Important Reminder

As with any system, there are limits to ACC. Use the brake pedal whenever necessary, and always keep a safe interval between your vehicle and other vehicles.

Be careful not to have the radar sensor cover strongly impacted.

* Not available on all models

■ How to activate the system

How to use

ACC (green) is on in the multi-information display. Adaptive cruise control is ready to use.

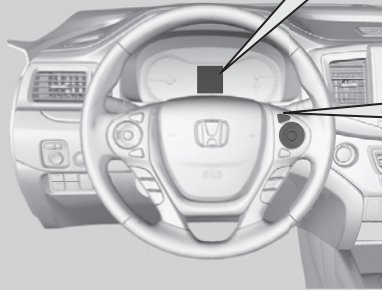

■ Press the **MAIN** button on the steering wheel.

▶ Adaptive Cruise Control (ACC)*

When the **MAIN** button is pressed, both ACC and the Lane Keeping Assist System (LKAS) are either turned on or off.

ACC may not work properly under certain conditions.

▶ **ACC Conditions and Limitations** P. 460

When not using ACC: Turn off adaptive cruise by pressing the **MAIN** button. This also will turn off the Lane Keeping Assist System (LKAS).

Do not use ACC under the following conditions:

- On roads with heavy traffic or while driving in continuous stop and go traffic.
- On roads with sharp turns.
- On roads with steep downhill sections, as the set vehicle speed can be exceeded by coasting. In such cases, ACC will not apply the brakes to maintain the set speed.
- On roads with toll collection facilities or other objects between lanes of traffic, or in parking areas, or facilities with drive through access.

■ To Set the Vehicle Speed

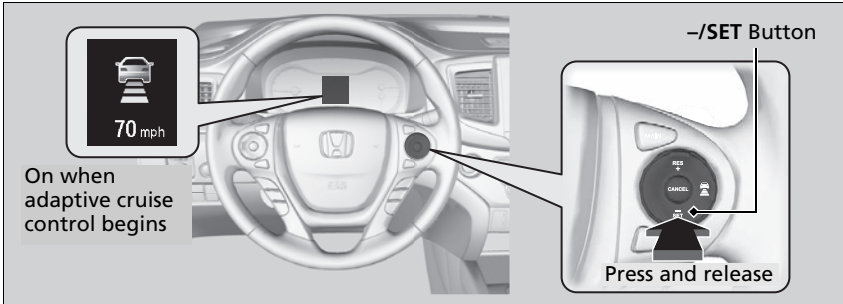

Take your foot off the pedal and press down the **-/SET** button when you reach the desired speed. The moment you release the button, the set speed is fixed, and ACC begins.

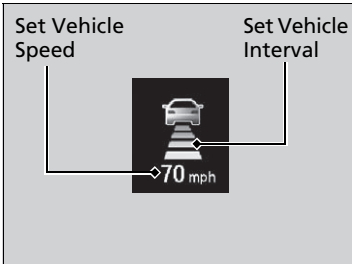

When ACC starts operating, the vehicle icon, interval bars and set speed appear on the multi-information display.

▶ To Set the Vehicle Speed

You can switch the displayed set speed measurements on the audio/information screen between mph and km/h.

▶ **Customized Features** P. 317

■ When in Operation

■ There is a vehicle ahead

ACC monitors if a vehicle ahead of you enters the ACC range. If a vehicle is detected doing so, the ACC system maintains or decelerates your vehicle's set speed in order to keep the vehicle's set following interval from the vehicle ahead.

➔ **To Set or Change Following Interval** P. 463

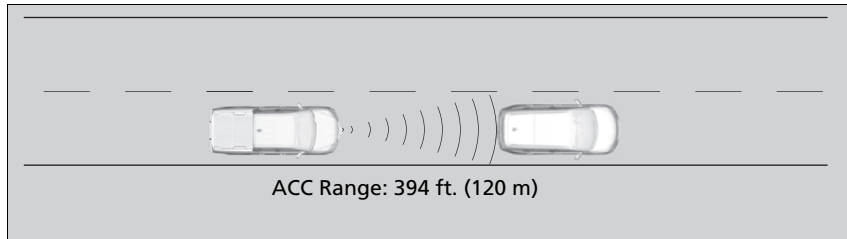

A vehicle icon appears on the multi-information display

When a vehicle whose speed is slower than your set speed is detected in front of you, your vehicle starts to slow down.

▶▶ When in Operation

If the vehicle ahead of you slows down abruptly, or if another vehicle cuts in front of you, the beeper sounds, a message appears on the multi-information display.

Depress the brake pedal, and keep an appropriate interval from the vehicle ahead.

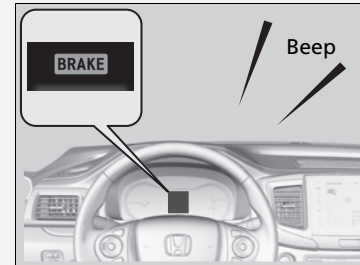

Even if the interval between your vehicle and the vehicle ahead is short, ACC may start accelerating your vehicle under the following circumstances:

- The vehicle ahead of you is going at almost the same speed as, or faster than, your vehicle.
- A vehicle that cuts in front of you is going faster than your vehicle, gradually increasing the interval between the vehicles.

You can also set the system to beep when a vehicle in front of you comes in and goes out of the ACC detecting range. Change the **ACC Forward Vehicle Detect Beep** setting.

➔ **Customized Features** P. 317

■ There is no vehicle ahead

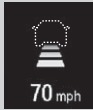

A vehicle icon with dotted-line contour appears on the multi-information display.

Your vehicle maintains the set speed without having to keep your foot on the brake or accelerator pedal.

If there previously was a vehicle detected ahead that kept your vehicle from traveling at the set speed, ACC accelerates your vehicle to the set speed, and then maintains it.

■ When you depress the accelerator pedal

You can temporarily increase the vehicle speed.

ACC stays on unless you cancel it. Once you release the accelerator pedal, the system resumes the set speed or a sufficient speed to keep the following interval.

⌘ When you depress the accelerator pedal

While the accelerator pedal is depressed, the system does not apply the brakes to keep the following interval, as well as the **BRAKE** message on the multi-information display does not appear.

➤ **When in Operation** P. 458

ACC Conditions and Limitations

The system may automatically shut off and the **ACC** indicator will come on under certain conditions. Some examples of these conditions are listed below. Other conditions may reduce some of the ACC functions.

➤ **Front Sensor Camera*** P. 448

■ Environmental conditions

Driving in bad weather (rain, fog, snow, etc.).

■ Roadway conditions

Driving on a snowy or wet roadway (obscured lane marking, vehicle tracks, reflected lights, road spray, high contrast).

■ Vehicle conditions

- The outside of the windshield is blocked by dirt, mud, leaves, wet snow, etc.
- An abnormal tire or wheel condition (wrong sized, varied size or construction, improperly inflated, compact spare tire, etc.).
- The camera temperature gets too high.
- The parking brake is applied.
- When the radar sensor cover is dirty.
- The vehicle is tilted due to a heavy load or suspension modifications.
- When tire chains are installed.

ACC Conditions and Limitations

The radar sensor for ACC is shared with the collision mitigation braking system™ (CMBS™).

➤ **Collision Mitigation Braking System™ (CMBS™)*** P. 492

Do not put a sticker on the radar sensor cover or replace the radar sensor cover.

Have your vehicle checked by a dealer if you find any unusual behavior of the system (e.g., the warning message appears too frequently).

If the front of the vehicle is impacted in any of the following situations, the radar sensor may not work properly. Have your vehicle checked by a dealer:

- The vehicle mounted onto a bump, curb, chock, embankment, etc.
- You drive the vehicle where the water is deep.
- Your vehicle has a frontal collision.

You can read about handling information for the camera equipped with this system.

➤ **Front Sensor Camera*** P. 448

■ Detection limitations

- A vehicle or pedestrian suddenly crosses in front of you.
- The interval between your vehicle and the vehicle or pedestrian ahead of you is too short.
- A vehicle cuts in front of you at a slow speed, and it brakes suddenly.
- When you accelerate rapidly and approach the vehicle or pedestrian ahead of you at high speed.
- The vehicle ahead of you is a motorcycle, bicycle, mobility scooter, or other small vehicle.
- When there are animals in front of your vehicle.
- When you drive on a curved or winding or undulating road that makes it difficult for the sensor to properly detect a vehicle or a pedestrian in front of you.
- The speed difference between your vehicle and a vehicle or pedestrian in front of you is significantly large.
- An oncoming vehicle suddenly comes in front of you.
- Your vehicle abruptly crosses over in front of an oncoming vehicle.
- When driving through a narrow iron bridge.
- When the vehicle ahead of you brakes suddenly.
- When the vehicle ahead of you has a unique shape.
- When your vehicle or the vehicle ahead of you is driving on one edge of the lane.

■ To Adjust the Vehicle Speed

Increase or decrease the vehicle speed using the **RES/+** or **-/SET** buttons on the steering wheel.

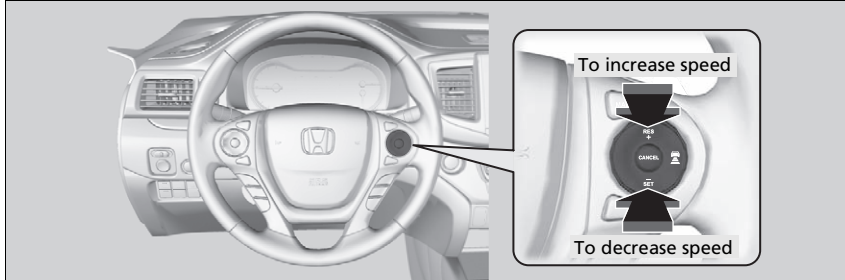

- Each time you press the button, the vehicle speed is increased or decreased by about 1 mph or 1 km/h accordingly.
- If you keep the button pressed, the vehicle speed increases or decreases by about 5 mph or 5 km/h accordingly.

▶▶ To Adjust the Vehicle Speed

If a vehicle detected ahead is going at a speed slower than your increased set speed, ACC may not accelerate your vehicle. This is to maintain the set following interval between your vehicle and the vehicle ahead.

You can set the vehicle speed using the **-/SET** button on the steering wheel when adjusting the speed with the accelerator and brake pedals.

■ To Set or Change Following Interval

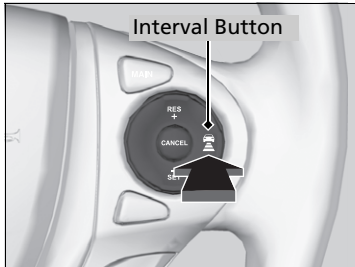





Press the  (interval) button to change the ACC following interval.

Each time you press the button, the following interval (the interval behind a vehicle detected ahead of you) setting cycles through extra long, long, middle, and short following interval.

Determine the most appropriate following interval setting based on your specific driving conditions. Be sure to adhere to any following interval requirements set by local regulation.

The higher your vehicle's following-speed is, the longer the short, middle, long or extra long following interval becomes. See the following examples for your reference.

Vehicle Interval		When the Set Speed is:	
		50 mph (80 km/h)	65 mph (104 km/h)
Short		83 feet 25 meters 1.1 sec	100 feet 31 meters 1.1 sec
Middle		110 feet 33 meters 1.5 sec	137 feet 42 meters 1.5 sec
Long		154 feet 47 meters 2.1 sec	200 feet 61 meters 2.1 sec
Extra Long		204 feet 62 meters 2.8 sec	265 feet 81 meters 2.8 sec

To Cancel

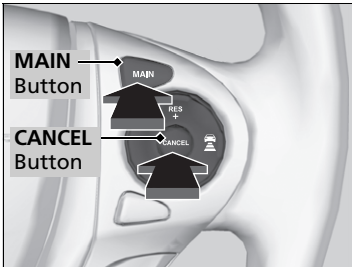

To cancel ACC, do any of the following:

- Press the **CANCEL** button.
- Press the **MAIN** button.
 - ▶ The **ACC** indicator (green) goes off.
- Depress the brake pedal.

Automatic cancellation

The beeper sounds and a message appears on the multi-information display when ACC is automatically canceled. Any of these conditions may cause the ACC to automatically cancel:

- Bad weather (rain, fog, snow, etc.).
- When the radar sensor inside the front grille gets dirty.
- The vehicle ahead of you cannot be detected.
- An abnormal tire condition is detected, or the tires are skidding.
- Driving on a mountainous road, or driving off road for extended periods.
- Abrupt steering wheel movement.
- When the ABS, VSA®, or CMBS™ is activated.
- When the ABS or VSA® system indicator comes on.
- When you manually apply the parking brake.
- When the detected vehicle within the ACC range is too close to your vehicle.
- The camera behind the rearview mirror, or the area around the camera, including the windshield, gets dirty.

To Cancel

Resuming the prior set speed: After you have canceled ACC, you can resume the prior set speed while it is still displayed. Press the **RES/+** button when driving at a speed of at least 25 mph (40 km/h) or more.

The set speed cannot be set or resumed when ACC has been turned off using the **MAIN** button. Press the **MAIN** button to activate the system, then set the desired speed.

Automatic cancellation

Even though adaptive cruise control has been automatically canceled, you can still resume the prior set speed. Wait until the condition that caused ACC to cancel improves, then press the **RES/+** button.

■ To Switch ACC to Cruise Control

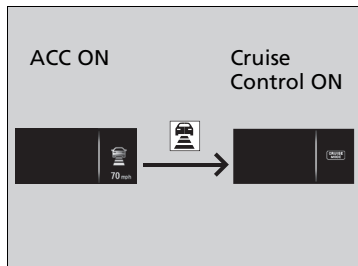

Press and hold the  (interval) button for one second. **Cruise Mode Selected** appears on the multi-information display for two seconds, and then the mode switches to Cruise.

To switch back to ACC, press and hold the  button again for one second. **ACC Mode Selected** appears on the multi-information display for two seconds.

■ When to use

Desired speed in a range above roughly 25 mph (40 km/h) ~.

■ To Set the Vehicle Speed

Take your foot off the pedal and press the **-/SET** button when you reach the desired speed.

The moment you release the **-/SET** button, the set speed is fixed, and cruise control begins. The **CRUISE CONTROL** indicator comes on.

■ To Adjust the Vehicle Speed

Each time you press the **RES/+** or **-/SET** button, the vehicle speed is increased or decreased by about 1 mph (1.6 km/h).

If you keep the **RES/+** or **-/SET** button pressed, the vehicle speed increases or decreases until you release it. This speed is then set.

▶▶ To Switch ACC to Cruise Control

Always be aware which mode you are in. When you are driving in **Cruise mode**, the system will not assist you to maintain a following interval from a vehicle ahead of you.

■ To Cancel

To cancel cruise control, do any of the following:

- Press the **CANCEL** button.
- Press the **MAIN** button.
- Depress the brake pedal.

The **CRUISE CONTROL** indicator goes off.

☒ To Cancel

Resuming the prior set speed:

After cruise control has been canceled, you can still resume the prior set speed by pressing the **RES/+** button while driving at a speed of at least 25 mph (40 km/h) or more.

You cannot set or resume in the following situations:

- When vehicle speed is less than 25 mph (40 km/h)
- When the **MAIN** button is turned off.

At vehicle speeds of 22 mph (35 km/h) or less, cruise control canceled automatically.

Lane Keeping Assist System (LKAS)*

Provides steering input to help keep the vehicle in the middle of a detected lane and provides tactile and visual alerts if the vehicle is detected drifting out of its lane.

■ Steering input assist

The system applies torque to the steering to keep the vehicle between the left and right lane lines. The applied torque becomes stronger as the vehicle gets closer to either of the lane lines.



■ LKAS camera
Monitors the lane lines

■ Tactile and visual alerts

Rapid vibrations on the steering wheel and a warning display alert you that the vehicle is drifting out of a detected lane.

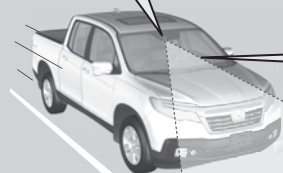

When you operate the turn signals to change lanes, the system is suspended, and resumes after the signals are off.

If you make a lane change without operating the turn signals, the LKAS alerts activate, and torque is applied to the steering.

▶ Lane Keeping Assist System (LKAS)*

Important Safety Reminders

The LKAS is for your convenience only. It is not a substitute for your vehicle control. The system does not work if you take your hands off the steering wheel or fail to steer the vehicle.

▶ Multi-Information Display Warning and Information Messages P. 101

Do not place objects on the instrument panel. Objects may reflect on the front windshield and prevent correct detection of the traffic lanes.

LKAS only alerts you when lane drift is detected without a turn signal in use. LKAS may not detect all lane markings or lane departures; accuracy will vary based on weather, speed, and lane marker condition. It is always your responsibility to safely operate the vehicle and avoid collisions.

The LKAS is convenient when it is used on freeways.

The LKAS may not work properly or may work improperly under the certain conditions:

▶ LKAS Conditions and Limitations P. 474

LKAS may not function as designed on while driving in frequent stop and go traffic, or on roads with sharp curves.

You can read about handling information for the camera equipped with this system.

▶ Front Sensor Camera* P. 448

■ Lane Keep Support Function

Provides assistance to keep the vehicle in the center of the lane, when the vehicle nears a white or yellow line, steering force of the electric power steering will become stronger.

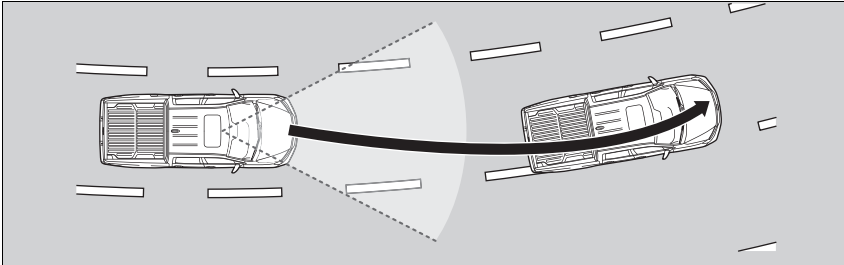

■ Lane Departure Warning Function

When the vehicle enters the warning area, LKAS alerts you with slight steering wheel vibration as well a warning display.

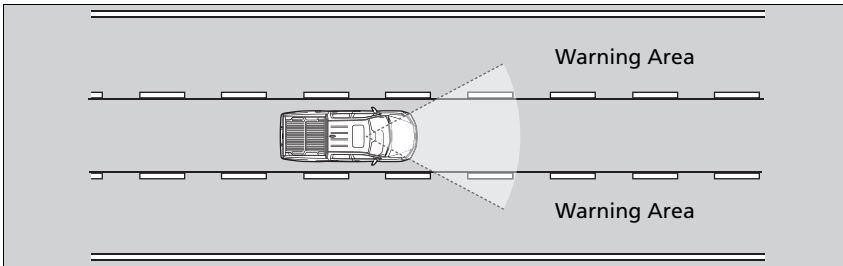

☒ Lane Keeping Assist System (LKAS)*

When the vehicle enters the warning area, lane departure warning is provided by steering wheel vibration and display.

* Not available on all models

■ When the System can be Used

The system can be used when the following conditions are met.

- The lane in which you are driving has detectable lane markers on both sides, and your vehicle is in the center of the lane.
- The vehicle speed is between about 45 and 90 mph (72 and 145 km/h).
- You are driving on a straight or slightly curved road.
- The turn signals are off.
- The brake pedal is not depressed.
- The wipers are not in continuous operation.

■ How to activate the system

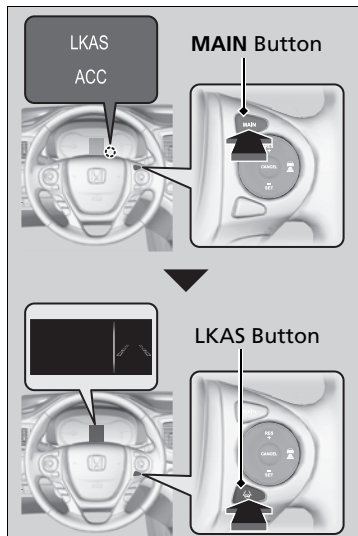

1. Press the **MAIN** button.

- ▶ The **ACC** and **LKAS** indicators come on.
The system is ready to use.

2. Press the **LKAS** button.

- ▶ Lane outlines appear on the multi-information display.
The system is activated.

▶ Lane Keeping Assist System (LKAS)*

You can read about handling information for the camera equipped with this system.

▶ **Front Sensor Camera*** P. 448

If the vehicle drifts toward either left or right lane line due to the system applying torque, turn off the LKAS and have your vehicle checked by a dealer.

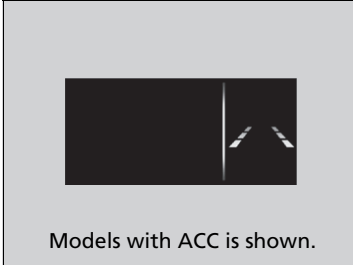

3. Keep your vehicle near the center of the lane while driving.
 - ▶ The dotted outer lines change to solid ones once the system starts operating after detecting the left and right lane markings.

To cancel

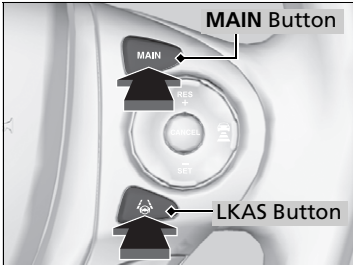

To cancel the LKAS:
Press the **MAIN** or LKAS button.

The LKAS is turned off every time you stop the engine, even if you turned it on the last time you drove the vehicle.

When the System can be Used

The LKAS temporarily deactivates when it fails to detect lane lines. When the system detects the lines again, it comes back on automatically.

To cancel

Pressing the **MAIN** button also turns ACC on and off.



When the LKAS is suspended, the lane lines on the Multi-Information Display change to contour lines, and the beeper sounds.

■ **The system operation is suspended if you:**

- Set the wipers to continuous operation.
 - ▶ Turning the wipers off resumes the LKAS.
- Decrease the vehicle speed to about 40 mph (64 km/h) or less.
 - ▶ Increasing the vehicle speed to about 45 mph (72 km/h) or more resumes the LKAS.
- Depress the brake pedal.
 - ▶ The LKAS resumes and starts detecting the lane lines again once you release the brake pedal.

Models with automatic intermittent wipers

- Set the wiper switch to **AUTO** and the wipers operate continuously.
 - ▶ The LKAS resumes when the wipers stop or operate intermittently.

■ **The LKAS may automatically be suspended when:**

- The system fails to detect lane lines.
- The steering wheel is quickly turned.
- You fail to steer the vehicle.
- The vehicle speed is over the posted speed limit, on a curve road.

Once these conditions no longer exist, the LKAS automatically resumes.

■ **The LKAS may automatically be canceled when:**

- The camera temperature gets too high.
- The camera behind the rearview mirror, or the area around the camera, including the windshield, gets dirty.
- When driving through a sharp curve.
- When driving at a speed in excess of approximately 90 mph (145 km/h).
- When the ABS or VSA® systems engage.

A beeper will sound if the LKAS is automatically canceled.

■ LKAS Conditions and Limitations

The system may not detect lane markings and therefore may not keep the vehicle in the middle of a lane under certain conditions, including the following:

■ Environmental conditions

- Driving in bad weather (rain, fog, snow, etc.).
- Sudden changes between light and dark, such as an entrance or exit of a tunnel.
- There is little contrast between lane lines and the roadway surface.
- Driving into low sunlight (e.g., at dawn or dusk).
- Strong light is reflected onto the roadway.
- Driving in the shadows of trees, buildings, etc.
- Shadows of adjacent objects are parallel to lane markings.
- Roadway objects or structures are misinterpreted as lane markers.
- Reflections on the interior of the front windshield.

■ Roadway conditions

- Driving on a snowy or wet roadway (obscured lane marking, vehicle tracks, reflected lights, road spray, high contrast).
- Driving on a road with temporary lane markings.
- Faint, multiple, or varied lane markings are visible on the roadway due to road repairs or old lane markings.
- The roadway has merging, split, or crossing lines (e.g., such as at an intersection or crosswalk).
- The lane markings are extremely narrow, wide, or changing.
- The vehicle in front of you is driving near the lane lines.
- The road is hilly or the vehicle is approaching the crest of a hill.
- Driving on rough or unpaved roads, or over bumpy surfaces.
- When objects on the road (curb, guard rail, pylons, etc.) are recognized as white lines (or yellow lines).
- When driving on roads with double lines.

■ Vehicle conditions

- Headlight lenses are dirty or the headlights are not properly adjusted.
- The outside of the windshield is streaked or blocked by dirt, mud, leaves, wet snow, etc.
- The inside of the windshield is fogged.
- The camera temperature gets too hot.
- An abnormal tire or wheel condition (wrong sized, varied size or construction, improperly inflated, compact spare tire, etc.).
- The vehicle is tilted due to a heavy load or suspension modifications.

Vehicle Stability Assist (VSA®), aka Electronic Stability Control (ESC), System

VSA® helps to stabilize the vehicle during cornering if the vehicle turns more or less than what was intended. It also assists in maintaining traction on slippery surfaces. It does so by regulating engine output and selectively applying the brakes.

▶▶ Vehicle Stability Assist (VSA®), aka Electronic Stability Control (ESC), System

The VSA® may not function properly if tire type and size are mixed. Make sure to use the same size and type of tire, and the air pressures as specified.

When the VSA® indicator comes on and stays on while driving, there may be a problem with the system. While this may not interfere with normal driving, have your vehicle checked by a dealer immediately.

VSA® cannot enhance stability in all driving situations and does not control the entire braking system. You still need to drive and corner at speeds appropriate for the conditions and always leave a sufficient margin of safety.

The main function of the VSA® system is generally known as Electronic Stability Control (ESC). The system also includes a traction control function.

■ VSA® Operation

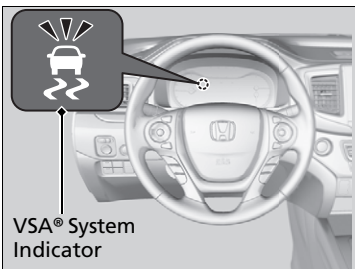

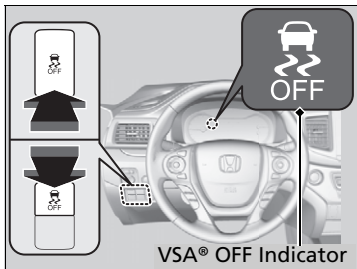

When VSA® activates, you may notice that the engine does not respond to the accelerator. You may also notice some noise from the hydraulic system. You will also see the indicator blink.

VSA® On and Off



This button is on the driver side control panel. To partially disable VSA® functionality/features, press and hold it until you hear a beep.

The traction control stops fully functioning, allowing the wheels to spin more freely at low speed. The VSA® OFF indicator will also come on and a message on the multi-information display informs you that the mode is changed. Traction control mode can not be changed during Mud* or Sand* modes. If you are driving on mud or sand, Mud* or Sand* Intelligent Traction Management modes can also be used to free a stuck vehicle. On other road surfaces, change to Normal or Snow mode, then press and hold the  (VSA® OFF) button.

To restore VSA® functionality/features, press the  (VSA® OFF) button until you hear a beep.

VSA® is turned on every time you start the engine, even if you turned it off the last time you drove the vehicle.

Vehicle Stability Assist (VSA®), aka Electronic Stability Control (ESC), System

With the  button pressed, your vehicle will have normal braking and cornering ability, but VSA® traction and stability enhancement becomes less effective.

In certain unusual conditions when your vehicle gets stuck in shallow mud or fresh snow, it may be easier to free it with the VSA® temporarily switched off.

When the  button is pressed, the traction control function becomes less effective. This allows for the wheels to spin more freely at low speed. You should only attempt to free your vehicle with the VSA® off if you are not able to free it when the VSA® is on.

Immediately after freeing your vehicle, be sure to switch VSA® on again. We do not recommend driving your vehicle with the VSA® system switched off.

You may hear a motor sound coming from the engine compartment while system checks are being performed immediately after starting the engine or while driving. This is normal.

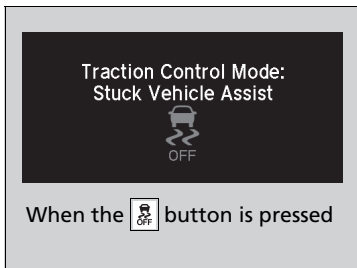

* Not available on all models

Agile Handling Assist

Lightly brakes each of the front and rear wheels, as needed, when you turn the steering wheel, and helps support the vehicle's stability and performance during cornering.

ⓘ Agile Handling Assist

The agile handling assist cannot enhance stability in all driving situations. You still need to drive and corner at speeds appropriate for the conditions and always leave a sufficient margin of safety.

When the VSA® indicator comes on and stays on while driving, the agile handling assist does not activate.

You may hear a sound coming from the engine compartment while the agile handling assist is activated. This is normal.

i-VTM4 (Intelligent Variable Torque Management)-4® System*

The Intelligent Variable Torque Management System (i-VTM4) is a full time all wheel drive system that automatically controls and transfers varying amount of engine torque to all wheels independently according to the driving conditions.

You still need to exercise the same care when accelerating, steering, and braking that you would in a two wheel drive vehicle.

If the AWD light blinks while driving, it indicates the differential temperature is too high. If this happens, pull to the side of the road when it is safe, shift to park, an idle the engine idle until the indicator goes out. If the indicator does not go out, take your vehicle to a dealer to have it checked.

⚠ i-VTM4 (Intelligent Variable Torque Management)-4® System*

NOTICE

Do not continuously spin the front tires of your vehicle. Continuously spinning the front tires can cause transmission or rear differential damage.

The i-VTM4 system may not function properly if tire type and size are mixed. Make sure to use the same size and type of tire, and the air pressures as specified.

➡ **Tire and Wheel Replacement** P. 551

* Not available on all models

TPMS with Tire Fill Assist

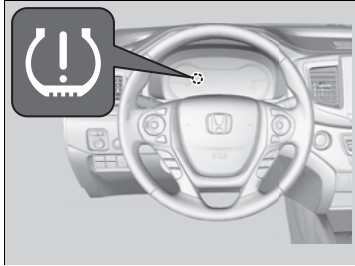

Monitors the tire pressure while you are driving. If your vehicle's tire pressure becomes significantly low, the Low Tire Pressure/TPMS indicator comes on and a message appears on the multi-information display.

▶ TPMS with Tire Fill Assist

Conditions such as low ambient temperature and altitude change directly affect tire pressure and can trigger the Low Tire Pressure/TPMS indicator to come on.

▶ If the Low Tire Pressure/Tire Pressure Monitoring System (TPMS) Indicator Comes On or Blinks P. 588

Tire pressure checked and inflated in:

- Warm weather can become under-inflated in colder weather.
- Cold weather can become over-inflated in warmer weather.

The Low Tire Pressure/TPMS indicator will not come on as a result of over inflation.

The TPMS audibly and visually informs you of changes in tire pressure of the individual tire that you are adjusting using audible and visual indications.

If a change in tire pressure has been significant, the system beeps and the hazard lights flash continuously for five seconds when the specified tire pressure is reached. Stop filling the tire.

Tire Pressure Monitor



To select the tire pressure monitor, set the power mode to ON, and press the  (information) button until you see the tire pressure screen.

The pressure for each tire is displayed in psi.



Tire Pressures Low is displayed when a tire has significantly low pressure. The specific tire is displayed on the screen.

▶▶ Tire Pressure Monitor

The pressure displayed on the multi-information display can be slightly different from the actual pressure as measured by a gauge. If there is a significant difference between the two values, or if the Low Tire Pressure/TPMS indicator and the message on the multi-information display do not go off after you have inflated the tire to the specified pressure, have the system checked by a dealer.

Tire Pressure Monitor Problem may appear if you drive with the compact spare tire, or there is a problem with the TPMS.

Tire Pressure Monitoring System (TPMS) - Required Federal Explanation

Each tire, including the spare (if provided), should be checked monthly when cold and inflated to the inflation pressure recommended by the vehicle manufacturer on the vehicle placard or tire inflation pressure label.

(If your vehicle has tires of a different size than the size indicated on the vehicle placard or tire inflation pressure label, you should determine the proper tire inflation pressure for those tires.)

As an added safety feature, your vehicle has been equipped with a tire pressure monitoring system (TPMS) that illuminates a low tire pressure telltale



when one or more of your tires is significantly under-inflated.

Accordingly, when the low tire pressure telltale illuminates, you should stop and check your tires as soon as possible, and inflate them to the proper pressure.

Driving on a significantly under-inflated tire causes the tire to overheat and can lead to tire failure. Under-inflation also reduces fuel efficiency and tire tread life, and may affect the vehicle's handling and stopping ability.

Please note that the TPMS is not a substitute for proper tire maintenance, and it is the driver's responsibility to maintain correct tire pressure, even if under-inflation has not reached the level to trigger illumination of the TPMS low tire pressure telltale.

Your vehicle has also been equipped with a TPMS malfunction indicator to indicate when the system is not operating properly. The TPMS malfunction indicator is combined with the low tire pressure telltale. When the system detects a malfunction, the telltale will flash for approximately one minute and then remain continuously illuminated. This sequence will continue upon subsequent vehicle start-ups as long as the malfunction exists.

When the malfunction indicator is illuminated, the system may not be able to detect or signal low tire pressure as intended.

TPMS malfunctions may occur for a variety of reasons, including the installation of replacement or alternate tires or wheels on the vehicle that prevent the TPMS from functioning properly.

Always check the TPMS malfunction telltale after replacing one or more tires or wheels on your vehicle to ensure that the replacement or alternate tires and wheels allow the TPMS to continue to function properly.

Blind spot information (BSI) System*

Is designed to detect vehicles in specified alert zones adjacent to your vehicle, particularly in harder to see areas commonly known as "blind spots."

When the system detects vehicles approaching from behind in adjacent lanes, the appropriate indicator comes on for a few seconds, providing assistance when you change lanes.

■ How the system works

- The transmission is in **D**.
- Your vehicle speed is between 20 mph (32 km/h) and 100 mph (160 km/h)

Alert zone range

- A: Approx. 1.6 ft. (0.5 m)
- B: Approx. 10 ft. (3 m)
- C: Approx. 10 ft. (3 m)

Radar Sensors:
underneath the
rear bumper
corners

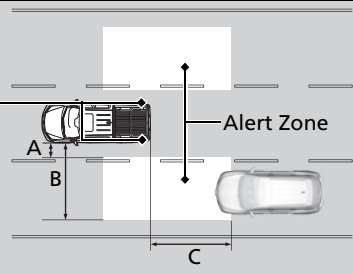

▶▶ Blind spot information (BSI) System*

⚠ WARNING

Failure to visually confirm that it is safe to change lanes before doing so may result in a crash and serious injury or death. Do not rely only on the blind spot information system when changing lanes.

Always look in your mirrors, to either side of your vehicle, and behind you for other vehicles before changing lanes.

Important Safety Reminder

Like all assistance systems, BSI has limitations. Over reliance on BSI may result in a collision.

The system is for your convenience only. Even if an object is within the alert zone, the following situations may occur.

- The BSI alert indicator may not come on due to obstruction (splashes, etc.) even without the **Blind Spot Info Not Available** multi-information display appearing.
- The BSI alert indicator may come on even with the message appearing.

The BSI alert indicator may not come on under the following conditions:

- A vehicle does not stay in the alert zone for more than two seconds.
- A vehicle is parked in a side lane.
- The speed difference between your vehicle and the vehicle you are passing is greater than 6 mph (10 km/h).
- An object not detected by the radar sensors approaches or passes your vehicle.

■ When the system detects a vehicle

BSI Alert Indicator: Located near the outside rearview mirror on both sides.

■ Comes on when

- A vehicle enters the alert zone from behind to overtake you with a speed difference of no more than 31 mph (50 km/h) from your vehicle.
- You pass a vehicle with a speed difference of no more than 12 mph (20 km/h).

■ Blinks and the beeper sounds when

You move the turn signal lever in the direction of the detected vehicle. The beeper sounds three times.

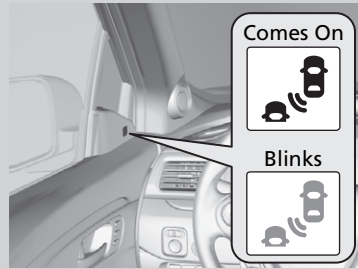

▣ Blind spot information (BSI) System*

You can change the setting for BSI.

➤ **Customized Features** P. 317

Turn the system off when towing a trailer.

The system may not work properly for the following reasons:

- The added mass tilts the vehicle and changes the radar coverage.
- The trailer itself can be detected by the radar sensors, causing the BSI alert indicators to come on.

BSI may be adversely affected when:

- Objects (guard rails, poles, trees, etc.) are detected.
- An object that does not reflect radio waves well, such as a motorcycle, is in the alert zone.
- Driving on a curved road.
- A vehicle is moving from a far lane to the adjacent lane.
- The system picks up external electrical interference.
- The rear bumper or the sensors have been improperly repaired or the rear bumper has been deformed.
- The orientation of the sensors has been changed.
- In bad weather (Heavy rain, snow, and fog).

For proper BSI use:

- Always keep the rear bumper corner area clean.
- Do not cover the rear bumper corner area with labels or stickers of any kind.
- Take your vehicle to a dealer if you need the rear bumper corner area or the radar sensors to be repaired, or the rear bumper corner area is strongly impacted.

* Not available on all models

LaneWatch™*

LaneWatch is an assistance system that allows you to check the passenger side rear areas displayed on the audio/information screen when the turn signal is activated to the passenger's side. A camera in the passenger side door mirror monitors these areas and allows you to check for vehicle, in addition to your visual check and use of the passenger door mirror. You can also keep the system on for your convenience while driving.

1 The system activates when you:



Move the turn signal lever to the passenger side. Press the LaneWatch button.



The system deactivates when you:

Pull the turn signal lever back. Press the LaneWatch button again.

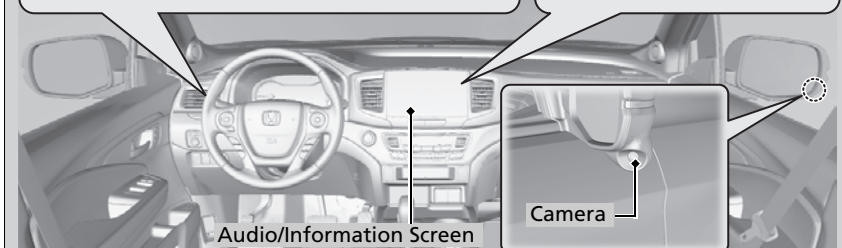
2 The passenger side view display appears on the audio/information screen.



Audio/Information Screen Camera

▶ LaneWatch™*

⚠ WARNING

Failure to visually confirm that it is safe to change lanes before doing so may result in a crash and serious injury or death.

Do not rely only on LaneWatch while driving.

Always look in your mirrors, to either side of your vehicle, and behind you for other vehicles before changing lanes.

Important Safety Reminder

Like all assistance systems, LaneWatch has limitations. Over reliance on LaneWatch may result in a collision.

The LaneWatch function can be affected by weather, lighting (including headlights and low sun angle), ambient darkness, camera condition, and loading.

The LaneWatch may not provide the intended display of traffic to the side and rear under the following conditions:

- Your vehicle's suspension has been altered, changing the height of the vehicle.
- Your tires are over or under inflated.
- Your tires or wheels are of varied size or construction.

■ Customizing the LaneWatch settings

You can customize the following items using the audio/information screen.

- **Show with Turn Signal:** Selects whether LaneWatch monitor comes on when you operate the turn signal light lever.
- **Display Time after Turn Signal Off:** Changes the remaining LaneWatch display time after you pull the turn signal lever back.
- **Reference Line:** Selects whether the reference lines appear on the LaneWatch monitor.
- **Display:** Adjusts display settings.
 🗨 Customized Features P. 317

■ Reference Lines

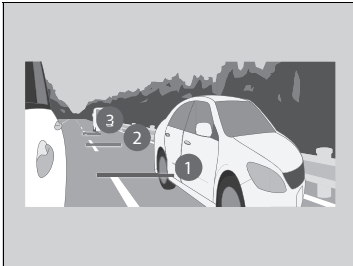

Three lines that appear on the screen can give an idea of how far the vehicles or objects on the screen are from your vehicle, respectively. If an object is near line 1 (in red), it indicates that it is close to your vehicle whereas an object near line 3 farther away.

📺 LaneWatch™*

The LaneWatch camera view is restricted. Its unique lens makes objects on the screen look slightly different from what they are.

LaneWatch display does not come on when the shift lever is in **[R]**.

For proper LaneWatch operation:

- The camera is located in the passenger side door mirror. Always keep this area clean. If the camera lens is covered with dirt or moisture, use a soft, moist cloth to keep the lens clean and free of debris.
- Do not cover the camera lens with labels or stickers of any kind.
- Do not touch the camera lens.

📺 Reference Lines

The area around the reference line 1 (red) is very close to your vehicle. As always, make sure to visually confirm the safety of a lane change before changing lanes.

The distance between your vehicle and lines 1, 2 and 3 on the screen vary depending on road conditions and vehicle loading. For example, the reference lines on the screen may seem to appear closer than the actual distances when the rear of your vehicle is more heavily loaded.

Consult a dealer if:

- The passenger side door mirror, or area around it is severely impacted, resulting in changing the camera angle.
- The LaneWatch display does not come on at all.

Brake System

Parking Brake

Use the parking brake to keep the vehicle stationary when parking.

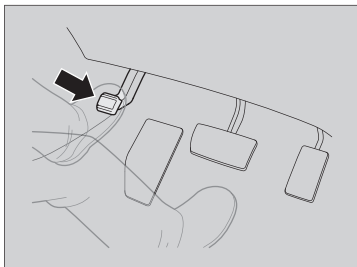

To apply:

Depress the parking brake pedal down with your foot.

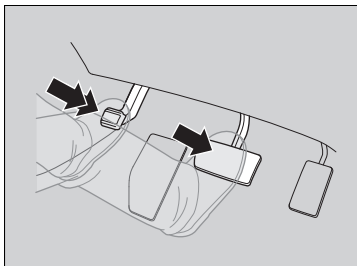

To release:

1. Depress the brake pedal.
2. Depress the parking brake.

» Parking Brake

NOTICE

Release the parking brake fully before driving. The rear brakes and axle can be damaged if you drive with the parking brake applied.

If you start driving without fully releasing the parking brake, a buzzer sounds as a warning, and **Release Parking Brake** appears on the multi-information display.

Always apply the parking brake when parking.

Foot Brake

Your vehicle is equipped with disc brakes at all four wheels. A vacuum power assist helps reduce the effort needed on the brake pedal. The brake assist system increases the stopping force when you depress the brake pedal hard in an emergency situation. The anti-lock brake system (ABS) helps you retain steering control when braking very hard.

🔧 **Brake Assist System** P. 491

🔧 **Anti-lock Brake System (ABS)** P. 490

🔧 Foot Brake

Check the brakes after driving through deep water, or if there is a buildup of road surface water. If necessary, dry the brakes by lightly depressing the pedal several times.

If you hear a continuous metallic friction sound when applying the brakes, this is caused by the brake wear indicator rubbing on the brake rotor and indicates that the brake pads need to be replaced. Have the vehicle checked by a dealer. If you hear only an occasional squeak or squeal when you initially apply the brake pedal, this may be normal and caused by high frequency vibration of the brake pads against the rotating brake disc.

Constantly using the brake pedal while going down a long hill builds up heat, which reduces the brake effectiveness. Apply engine braking by taking your foot off the accelerator pedal and downshifting to a lower gear.

Do not rest your foot on the brake pedal while driving, as it will lightly apply the brakes and cause them to lose effectiveness over time and reduce pad life. It will also confuse drivers behind you.

Anti-lock Brake System (ABS)

■ ABS

Helps prevent the wheels from locking up, and helps you retain steering control by pumping the brakes rapidly, much faster than you.

The electronic brake distribution (EBD) system, which is part of the ABS, also balances the front-to-rear braking distribution according to vehicle loading.

You should never pump the brake pedal. Let the ABS work for you by always keeping firm, steady pressure on the brake pedal. This is sometimes referred to as “stomp and steer.”

■ ABS operation

The brake pedal may pulsate slightly when the ABS is working. Keep holding the pedal firmly down. On dry pavement, you will need to press on the brake pedal very hard before the ABS activates. However, you may feel the ABS activate immediately if you are trying to stop on snow or ice.

ABS may activate when you depress the brake pedal when driving on:

- Wet or snow covered roads.
- Roads paved with stone.
- Roads with uneven surfaces, such as potholes, cracks, manholes, etc.

When the vehicle speed goes under 6 mph (10 km/h), the ABS stops.

►► Anti-lock Brake System (ABS)

NOTICE

The ABS may not function correctly if you use an incorrect tire type and size.

When the **ABS** indicator comes on while driving, there may be a problem with the system. While normal braking is not affected, there is a possibility of the ABS not operating. Have the vehicle checked by a dealer immediately.

The ABS does not reduce the time or distance it takes to stop the vehicle. It only helps with steering control during hard braking.

In the following cases, your vehicle may need more stopping distance than a vehicle without the ABS:

- When driving on rough road surfaces, including when driving on uneven surfaces, such as gravel or snow.
- When tire chains are installed.

The following may be observed with the ABS system:

- Motor sounds coming from the engine compartment when the brakes are applied, or when system checks are being performed after the engine has been started and while vehicle is accelerates.
- Brake pedal and/or the vehicle body vibration when ABS activates.

These vibrations and sounds are normal to ABS systems and are no cause for concern.

Brake Assist System

Designed to assist the driver by generating greater braking force when you depress the brake pedal hard during emergency braking.

■ Brake assist system operation

Press the brake pedal firmly for more powerful braking.

When brake assist operates, the pedal may wiggle slightly and an operating noise may be heard. This is normal. Keep holding the brake pedal firmly down.

Collision Mitigation Braking System™ (CMBS™)*

Can assist you when there is a possibility of your vehicle colliding with a vehicle or a pedestrian detected in front of yours. The CMBS™ is designed to alert you when a potential collision is determined, as well as to reduce your vehicle speed to help minimize collision severity when a collision is deemed unavoidable.

■ How the system works

When to use

The camera is located behind the rearview mirror.

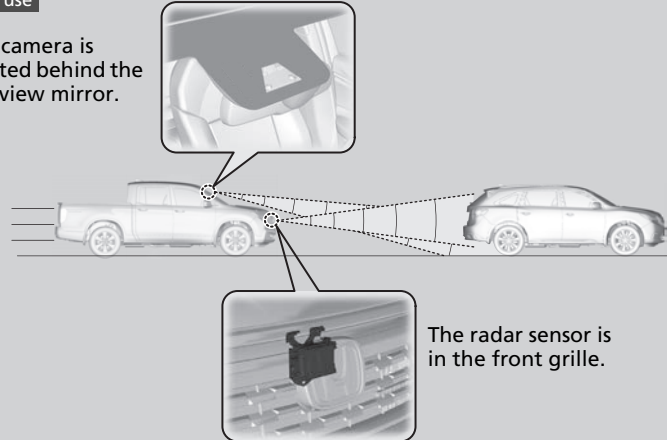

The radar sensor is in the front grille.

The system starts monitoring the roadway ahead when your vehicle speed is about 3 mph (5 km/h) and there is a vehicle in front of you.

The CMBS™ activates when:

- The speed difference between your vehicle and a vehicle or pedestrian detected in front of you becomes about 3 mph (5 km/h) and over with a chance of a collision.
- Your vehicle speed is about 62 mph (100 km/h) or less and there is a chance of a collision with an oncoming detected vehicle or a pedestrian in front of you.

►► Collision Mitigation Braking System™ (CMBS™)*

Important Safety Reminder

The CMBS™ is designed to reduce the severity of an unavoidable collision. It does not prevent collision nor stop the vehicle automatically. It is still your responsibility to operate the brake pedal and steering wheel appropriately according to the driving conditions.

The CMBS™ may not activate or may not detect a vehicle in front of your vehicle under certain conditions:

► **CMBS™ Conditions and Limitations** P. 496

You can read about handling information for the camera equipped with this system.

► **Front Sensor Camera*** P. 448

►► How the system works

Rapid vibrations on the steering wheel alert you when the your vehicle speed is between 19 and 62 mph (30 and 100 km/h) with an oncoming vehicle detected in front of you.

When CMBS activates, it may automatically apply the brakes. CMBS cancels when your vehicle stops, or a potential collision is no longer determined.

■ When the system activates

The system provides visual, audible and Tactile alerts of a possible collision, and stops if the collision is avoided.

- ▶ Take appropriate action to prevent a collision (apply the brakes, change lanes, etc.)

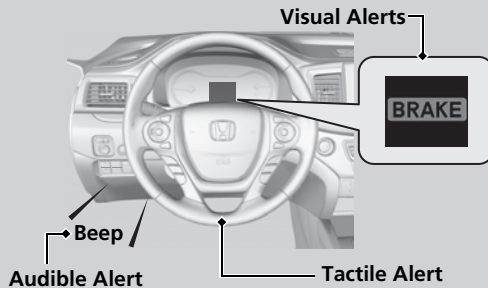

At system's earliest collision alert stage, you can change the distance (**Long/Normal/Short**) between vehicles at which alerts will come on through the audio/information screen's customized features.

■ Vibration alert on the steering wheel

When a potential collision to an oncoming detected vehicle is determined, the system alerts you with rapid vibration on the steering wheel, in addition to visual and audible alerts.

- ▶ Take appropriate action to prevent a collision (apply the brakes, operate the steering wheel, etc.).

▶▶ When the system activates

The camera in the CMBS™ is also designed to detect pedestrians.

However, this pedestrian detection feature may not activate or may not detect a pedestrian in front of your vehicle under certain conditions. Refer to the ones indicating the pedestrian detection limitations from the list.

- ▶ **CMBS™ Conditions and Limitations** P. 496

■ Collision Alert Stages

The system has three alert stages for a possible collision. However, depending on circumstances, the CMBS™ may not go through all of the stages before initiating the last stage.

Distance between vehicles		CMBS™			
		The sensors detect a vehicle	Audible & Visual WARNINGS	Steering Wheel	Braking
Stage one		There is a risk of a collision with the vehicle ahead of you.	When in Long , visual and audible alerts come on at a longer distance from a vehicle ahead than in Normal setting, and in Short , at a shorter distance than in Normal .	In case of an oncoming vehicle detected, rapid vibration is provided.	—
Stage two		The risk of a collision has increased, time to respond is reduced.	Visual and audible alerts.	—	Lightly applied
Stage three		The CMBS™ determines that a collision is unavoidable.		—	Forcefully applied

CMBS™ On and Off

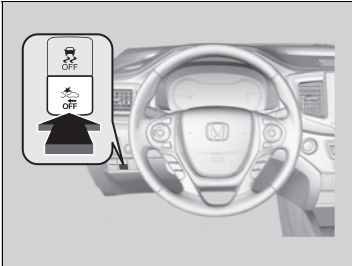

Press this button until the beeper sounds to switch the system on or off.

When the CMBS™ is off:

- The CMBS™ indicator in the instrument panel comes on.
- A message on the multi-information display reminds you that the system is off.

The CMBS™ is in the previously selected ON or OFF setting each time you start the engine.

Collision Mitigation Braking System™ (CMBS™)*

The CMBS™ may automatically shut off, and the CMBS™ indicator will come and stay on under certain conditions:

► **CMBS™ Conditions and Limitations** P. 496

* Not available on all models

■ CMBS™ Conditions and Limitations

The system may automatically shut off and the CMBS™ indicator will come on under certain conditions. Some examples of these conditions are listed below. Other conditions may reduce some of the CMBS™ functions.

➤ **Front Sensor Camera*** P. 448

■ Environmental conditions

- Driving in bad weather (rain, fog, snow, etc.).
- Sudden changes between light and dark, such as an entrance or exit of a tunnel.
- There is little contrast between objects and the background.
- Driving into low sunlight (e.g., at dawn or dusk).
- Strong light is reflected onto the roadway.
- Driving in the shadows of trees, buildings, etc.
- Roadway objects or structures are misinterpreted as vehicles and pedestrians.
- Reflections on the interior of the front windshield.

■ Roadway conditions

- Driving on a snowy or wet roadway (obscured lane marking, vehicle tracks, reflected lights, road spray, high contrast).
- The road is hilly or the vehicle is approaching the crest of a hill.
- Driving on curvy, winding, or undulating roads.

■ Vehicle conditions

- Headlight lenses are dirty or the headlights are not properly adjusted.
- The outside of the windshield is blocked by dirt, mud, leaves, wet snow, etc.
- The inside of the windshield is fogged.
- An abnormal tire or wheel condition (wrong sized, varied size or construction, improperly inflated, compact spare tire, etc.).
- When tire chains are installed.
- The vehicle is tilted due to a heavy load or suspension modifications.
- The camera temperature gets too hot.
- Driving with the parking brake applied.
- When the radar sensor in the front grille gets dirty.

■ Detection limitations

- A vehicle or pedestrian suddenly crosses in front of you.
- The distance between your vehicle and the vehicle or pedestrian ahead of you is too short.
- A vehicle cuts in front of you at a slow speed, and it brakes suddenly.
- When you accelerate rapidly and approach the vehicle or pedestrian ahead of you at high speed.
- The vehicle ahead of you is a motorcycle, bicycle, mobility scooter or other small vehicle.
- When there are animals in front of your vehicle.
- When you drive on a curved, winding or undulating road that makes it difficult for the sensor to properly detect a vehicle in front of you.
- The speed difference between your vehicle and a vehicle or pedestrian in front of you is significantly large.
- An oncoming vehicle suddenly comes in front of you.
- Another vehicle suddenly comes in front of you at an intersection, etc.
- Your vehicle abruptly crosses over in front of an oncoming vehicle.
- When driving through a narrow iron bridge.
- When a pedestrian blends in with the background.
- When a pedestrian is bent over or squatting, or when their hands are raised or they are running.
- When several pedestrians are walking ahead in a group.
- When the lead vehicle suddenly slows down.
- When the camera cannot correctly identify that a pedestrian is present due to an unusual shape (holding luggage, body position, size).

■ Automatic shutoff

CMBS™ may automatically shut itself off and the CMBS™ indicator comes and stays on when:

- The temperature inside the system is high.
- You drive off-road or on a mountain road, or curved and winding road for an extended period.
- An abnormal tire condition is detected (wrong tire size, flat tire, etc.).
- The camera behind the rearview mirror, or the area around the camera, including the windshield, gets dirty.

Once the conditions that caused CMBS™ to shut off improve or are addressed (e.g., cleaning), the system comes back on.

■ With Little Chance of a Collision

The CMBS™ may activate even when you are aware of a vehicle ahead of you, or when there is no vehicle ahead. Some examples of this are:

■ When Passing

Your vehicle approaches another vehicle ahead of you and you change lanes to pass.

■ At an intersection

Your vehicle approaches or passes another vehicle that is making a left or right turn.

■ On a curve

When driving through curves, your vehicle comes to a point where an oncoming vehicle is right in front of you.

■ Through a low bridge at high speed

You drive under a low or narrow bridge at high speed.

■ Speed bumps, road work sites, train tracks, roadside objects, etc.

You drive over speed bumps, steel road plates, etc., or your vehicle approaches train tracks or roadside objects [such as a traffic sign and guard rail] on a curve or, when parking, stationary vehicles and walls.

⚠ Collision Mitigation Braking System™ (CMBS™)*

For the CMBS™ to work properly:

Always keep the radar sensor cover clean.

Never use chemical solvents or polishing powder for cleaning the sensor cover. Clean it with water or a mild detergent.

Do not paint, or apply any coverings or paint to radar sensor area. This can impact CMBS operation.

If you need the radar sensor to be repaired, or removed, or the radar sensor cover is strongly impacted, turn off the system by pressing the CMBS™ off button and take your vehicle to a dealer.

When Stopped

1. Depress the brake pedal firmly.
2. Firmly apply the parking brake.
3. Move the shift lever from **D** to **P**.
4. Turn off the engine.

Always set the parking brake firmly, in particular if you are parked on an incline.

▣ Parking Your Vehicle

⚠ WARNING

The vehicle can roll away if left unattended without confirming that Park is engaged.

A vehicle that rolls away could cause a crash resulting in serious injury or death.

Always keep your foot on the brake pedal until you have confirmed that **P** is shown on the shift lever position Indicator.

Do not park your vehicle near flammable objects, such as dry grass, oil, or timber. Heat from the exhaust can cause a fire.

▣ When Stopped

NOTICE

The following can damage the transmission:

- Depressing the accelerator and brake pedals simultaneously.
- Changing into **P** before the vehicle stops completely.

When facing uphill, do not hold the vehicle by depressing the accelerator pedal.

Doing so may cause the items to malfunction or a fire inside the vehicle.

Parking Sensor System *

The corner and center sensors monitor obstacles near your vehicle. The beeper and audio/information screen let you know the approximate distance between your vehicle and the obstacle.

■ The sensor location and range

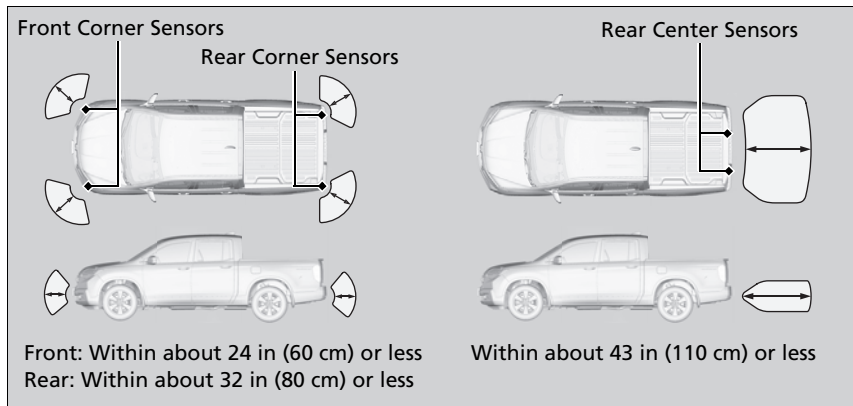

▶▶ Parking Sensor System *

Even when the system is on, always confirm if there is no obstacle near your vehicle before parking.

The system may not work properly when:

- The sensors are covered with snow, ice, mud or dirt, etc.
- The vehicle is on uneven surface, such as grass, bumpy road, or a hill.
- The vehicle has been out in hot or cold weather.
- The system is affected by devices that emit ultrasonic waves.
- Driving in bad weather.

The system may not sense:

- Thin or low objects.
- Sonic-absorptive materials, such as snow, cotton, or sponge.
- Objects directly under the bumper.

Do not put any accessories on or around the sensors.

■ Parking sensor system on and off

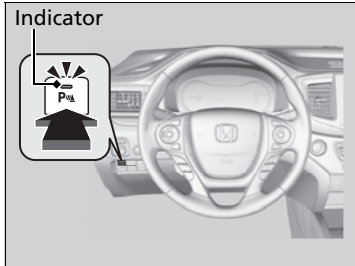

With the power mode in ON, press the parking sensor system button to turn on or off the system. The indicator in the button comes on when the system is on.

The rear center and corner sensors start to detect an obstacle when the shift lever is in **[R]**, and the vehicle speed is less than 5 mph (8 km/h).

The front corner sensors start to detect an obstacle when the shift lever is not in **[P]**, and the vehicle speed is less than 5 mph (8 km/h).

■ When the distance between your vehicle and obstacles behind becomes shorter

Length of the intermittent beep	Distance between the Bumper and Obstacle		Indicator	Audio/information screen
	Corner Sensors	Center Sensors		
Moderate	—	Rear: About 43-32 in (110-80 cm)	Blinks in Yellow*1	 <p>Indicators light where the sensor detects an obstacle</p>
Short	Front: About 24-18 in (60-45 cm) Rear: About 32-22 in (80-55 cm)	Rear: About 32-22 in (80-55 cm)	Blinks in Amber	
Very short	Front: About 18-14 in (45-35 cm) Rear: About 22-18 in (55-45 cm)	Rear: About 22-18 in (55-45 cm)	Blinks in Amber	
Continuous	Front: About 14 in (35 cm) or less Rear: About 18 in (45 cm) or less	Rear: About 18 in (45 cm) or less	Blinks in Red	

*1: At this stage, only the center sensors detect obstacles.

■ Turning off All Rear Sensors

1. Make sure that the parking sensor system is not activated. Set the power mode to VEHICLE OFF (LOCK).
2. Press and hold the parking sensor system button, and set the power mode to ON.
3. Keep pressing the button for 10 seconds. Release the button when the indicator in the button flashes.
4. Press the button again. The indicator in the button goes off.
 - ▶ The beeper sounds twice. The rear sensors are now turned off.

To turn the rear sensors on again, follow the above procedure. The beeper sounds three times when the rear sensors come back on.

☒ Turning off All Rear Sensors

When you shift to **[R]**, the indicator in the parking sensor system button blinks as a reminder that the rear sensors have been turned off.

Cross Traffic Monitor*

Monitors the rear corner areas using the radar sensors when reversing, and alerts you if a vehicle approaching from a rear corner is detected.

The system is convenient when you are backing out of a parking space.

⚠ Cross Traffic Monitor*

⚠ CAUTION

Cross Traffic Monitor cannot detect all approaching vehicles and may not detect an approaching vehicle at all.

Failure to visually confirm that it is safe to back up the vehicle before doing so may result in a collision.

Do not solely rely on the system when reversing; always also use your mirrors, and look behind and to the sides of your vehicle before reversing.

How the System Works

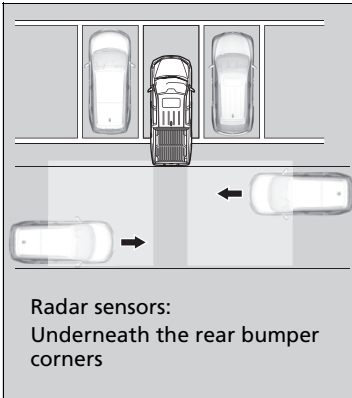

The system activates when:

- The power mode is in ON.
- The Cross Traffic Monitor system is turned on.
- ➔ **Cross Traffic Monitor On and Off** P. 509
- The shift lever is in **R**.
- Your vehicle is moving at 3 mph (5 km/h) or lower.

When a vehicle is detected approaching from a rear corner, Cross Traffic Monitor alerts you with a buzzer and a displayed warning.

The system will not detect a vehicle that approaches from directly behind your vehicle, nor will it provide alerts about a detected vehicle when it moves directly behind your vehicle.

The system does not detect or provide alerts for a vehicle that is moving away from your vehicle, and it may not detect or alert for pedestrians, bicycles, or stationary objects.

⊠ Cross Traffic Monitor*

Cross Traffic Monitor may not detect an approaching vehicle, or may delay alerting you under the following conditions:

- A vehicle, which is parked adjacent to your vehicle, is blocking the radar sensor's view.
- Your vehicle is moving at the speed of about 3 mph (5 km/h) or higher.
- A vehicle is approaching at the speed other than between about 6 and 16 mph (10 and 25 km/h).
- The system picks up external interference such as other radar sensors from another vehicle or strong radio wave transmitted from a facility nearby.
- Either corner of the rear bumper is covered with snow, ice, mud or dirt.
- When there is bad weather.
- Your vehicle is on an incline.
- Your vehicle is tilted due to a heavy load in the rear.
- The rear bumper or the sensors have been improperly repaired or the rear bumper has been deformed. Have a vehicle checked by a dealer.

For proper operation, always keep the rear bumper corner area clean.

Do not cover the rear bumper corner area with labels or stickers of any kind.

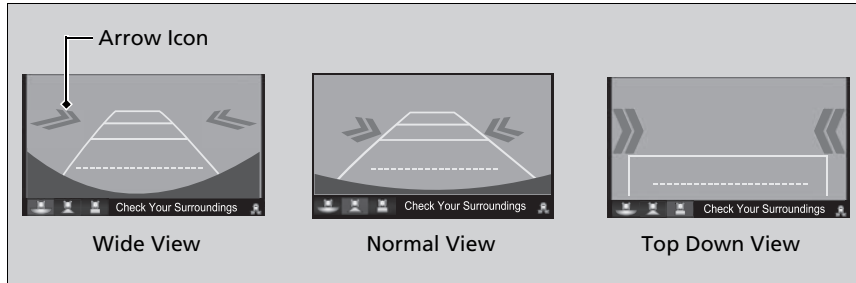

* Not available on all models

■ When the System Detects a Vehicle



An arrow icon appears on the side a vehicle is approaching on the audio/information screen.

▶▶ When the System Detects a Vehicle

If the  on the lower right changes to  when the shift lever is in **R**, mud snow or ice may have accumulated in the vicinity of the sensor. Check the bumper corners for any obstructions, and thoroughly clean the area if necessary.

If the  comes on when the transmission is in **R**, there may be a problem with the Cross Traffic Monitor system. Do not use the system and have your vehicle checked by a dealer.

■ Cross Traffic Monitor On and Off

You can switch on and off the system using the audio/information screen.

1. Select .
2. Select **Settings**.
3. Select **Camera**.
4. Select **Cross Traffic Monitor**.
5. Select **On** or **Off**, then select **OK**.

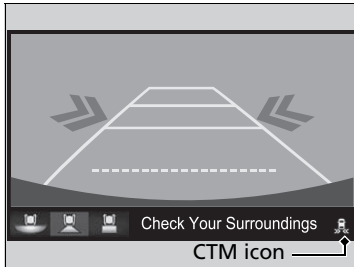

The system can also be turned on and off on the audio/information screen by pressing the CTM icon.

About Your Multi-View Rear Camera

The audio/information screen can display your vehicle's rear view. The display automatically changes to a rear view when the shift lever is moved to **R**.

Multi-View Rear Camera Display Area

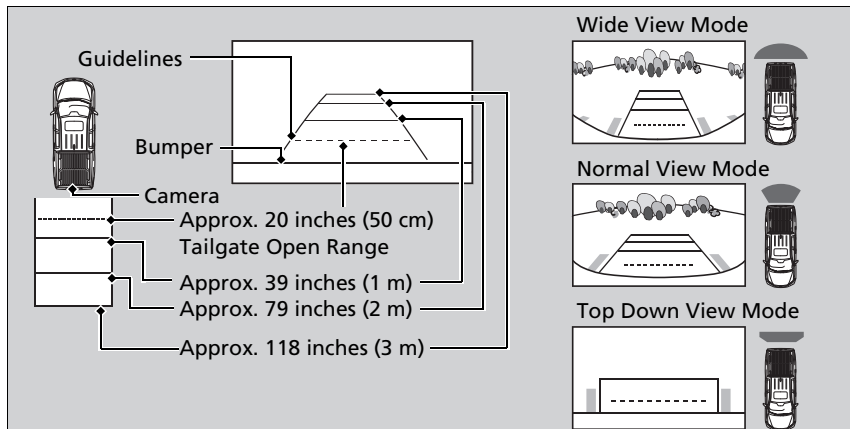



Models with color audio system

You can view three different camera angles on the rearview display. Press the selector knob to switch the angle.

Models with Display Audio

You can view three different camera angles on the rearview display. Touch the appropriate icon to switch the angle.

- : Wide view
- : Normal view
- : Top down view

About Your Multi-View Rear Camera

The rear camera view is restricted. You cannot see the corner ends of the bumper or what is underneath the bumper. Its unique lens also makes objects appear closer or farther than they actually are.

Visually confirm that it is safe to drive before backing up. Certain conditions (such as weather, lighting, and high temperatures) may also restrict the rear view. Do not rely on the rearview display which does not give you all information about conditions at the back of your vehicle.

If the camera lens is covered with dirt or moisture, use a soft, moist cloth to keep the lens clean and free of debris.

Models with color audio system

You can change the **Camera Guideline On** or **Off** settings.

 **Customized Features** P. 317

Models with Display Audio

You can change the **Fixed Guideline** and **Dynamic Guideline** settings.

 **Customized Features** P. 317

Fixed Guideline

On: Guidelines appear when you change the shift to **R**.

Off: Guidelines do not appear.

Dynamic Guideline

On: Guidelines move according to the steering wheel direction.

Off: Guidelines do not move.

All models

If the last used viewing mode is Wide or Normal, the same mode is selected the next time you shift into **R**. If Top view was last used, Wide mode is selected.

Fuel Information

■ Fuel recommendation

Unleaded gasoline, pump octane number 87 or higher

Use of lower octane gasoline can cause occasional metallic knocking noise in the engine and will result in decreased engine performance.

Use of gasoline with a pump octane less than 87 can lead to engine damage.

■ Top tier detergent gasoline

Because the level of detergency and additives in gasoline vary in the market, Honda endorses the use of "TOP TIER Detergent Gasoline" where available to help maintain the performance and reliability of your vehicle. TOP TIER Detergent Gasoline meets a new gasoline standard jointly established by leading automotive manufacturers to meet the needs of today's advanced engines.

Qualifying gasoline retailers will, in most cases, identify their gasoline as having met "TOP TIER Detergent Gasoline" standards at the retail location. This fuel is guaranteed to contain the proper level of detergent additives and be free of metallic additives. The proper level of detergent additives, and absence of harmful metallic additives in gasoline, help avoid build-up of deposits in your engine and emission control system.

For further important fuel-related information for your vehicle, or on information on gasoline that does not contain MMT, visit www.hondacars.com. In Canada, visit www.honda.ca for additional information on gasoline. For more information on top tier gasoline, visit www.toptiergas.com.

■ Fuel tank capacity: 19.5 US gal (73.8 ℓ)

» Fuel Information

NOTICE

We recommend quality gasoline containing detergent additives that help prevent fuel system and engine deposits. In addition, in order to maintain good performance, fuel economy, and emissions control, we strongly recommend the use of gasoline that does NOT contain harmful manganese-based fuel additives such as MMT, if such gasoline is available.

Use of gasoline with these additives may adversely affect performance, and cause the malfunction indicator lamp on your instrument panel to come on. If this happens, contact a dealer for service. Some gasoline today is blended with oxygenates such as ethanol. Your vehicle is designed to operate on oxygenated gasoline containing up to 15% ethanol by volume. Do not use gasoline containing methanol. If you notice any undesirable operating symptoms, try another service station or switch to another brand of gasoline.

How to Refuel

Your fuel tank is not equipped with a fuel filler cap. You can insert the filler nozzle directly into the filler neck. The tank seals itself again when you pull out the filler nozzle.

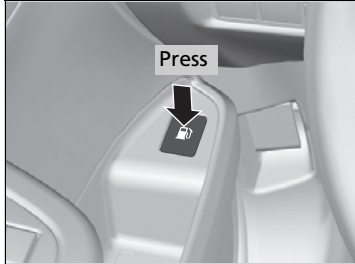

1. Stop your vehicle with the service station pump on the left side of the vehicle in the rear.
2. Turn off the engine.
3. Press the fuel fill door release button.
 - ▶ The fuel fill door opens.

How to Refuel

⚠ WARNING

Gasoline is highly flammable and explosive. You can be burned or seriously injured when handling fuel.

- Stop the engine, and keep heat, sparks, and flame away.
- Handle fuel only outdoors.
- Wipe up spills immediately.

NOTICE

The fuel filler opening is designed to accept only service station filler nozzles for refueling. Use of smaller diameter tubes (e.g., those used to siphon fuel for other uses) or other non-service station devices can damage the area in and around the filler opening.

The filler nozzle automatically stops to leave space in the fuel tank so that fuel does not overflow as a result of changes in air temperature.

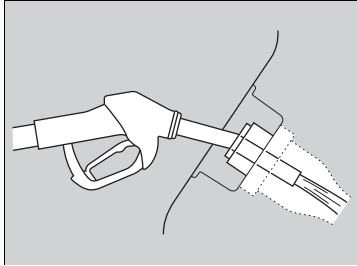

4. Place the end of the filler nozzle on the lower part of filler opening, then insert it slowly and fully.
 - ▶ Make sure that the end of the filler nozzle goes down along with the filler pipe.
 - ▶ Keep the filler nozzle level.
 - ▶ When the tank is full, the filler nozzle will click off automatically.
 - ▶ After filling, wait about five seconds before removing the filler nozzle.
5. Shut the fuel fill door by hand.

▶▶ How to Refuel

If the fuel filler nozzle keeps turning off when the tank is not full, there may be a problem with the pump's fuel vapor recovery system. Try filling at another pump. If this does not fix the problem, consult a dealer.

Do not continue to add fuel after the filler nozzle has automatically stopped. Additional fuel can exceed the full tank capacity.

If you have to refuel your vehicle from a portable container, use the funnel provided with your vehicle.

▶▶ **Refueling From a Portable Fuel Container**

P. 596

Improving Fuel Economy and Reducing CO₂ Emissions

Achieving fuel economy and reducing CO₂ emissions is dependent on several factors, including driving conditions, load weight, idling time, driving habits, and vehicle condition. Depending on these and other factors, you may not achieve the rated fuel economy of this vehicle.

Maintenance and Fuel Economy

You can optimize your fuel economy with proper maintenance of your vehicle. Always maintain your vehicle in accordance with the messages displayed on the multi-information display.

- Use the recommended viscosity engine oil, displaying the API Certification Seal.
- Maintain the specified tire pressure.
- Do not load the vehicle with excess cargo.
- Keep your vehicle clean. A buildup of snow or mud on your vehicle's underside adds weight and increases wind resistance.

Improving Fuel Economy and Reducing CO₂ Emissions

Direct calculation is the recommended method to determine actual fuel consumed while driving.

Miles driven	÷	Gallons of fuel	=	Miles per Gallon		
100	×	Liter	÷	Kilometers	=	L per 100 km

In Canada, posted fuel economy numbers are established following a simulated test. For more information on how this test is performed, please visit <http://oee.nrcan.gc.ca/>

Maintenance

This chapter discusses basic maintenance.



Before Performing Maintenance

Inspection and Maintenance	518
Safety When Performing Maintenance	519
Parts and Fluids Used in Maintenance Service	520

Maintenance Minder™

Maintenance Under the Hood

Maintenance Items Under the Hood	525
Opening the Hood	526
Engine Compartment Cover	527
Recommended Engine Oil	528
Oil Check	529
Adding Engine Oil	530
Changing the Engine Oil and Oil Filter	531

Engine Coolant	533
Transmission Fluid	535
Brake Fluid	536
Refilling Window Washer Fluid	536

Replacing Light Bulbs

Checking and Maintaining Wiper Blades

Checking and Maintaining Tires

Checking Tires	545
Tire and Loading Information Label	546
Tire Labeling	546
DOT Tire Quality Grading (U.S. Vehicles)	548
Wear Indicators	550

Tire Service Life	550
Tire and Wheel Replacement	551
Tire Rotation	552
Winter Tires	553

Battery

Remote Transmitter Care

Replacing the Button Battery	555
------------------------------------	-----

Heating and Cooling System*/Climate Control System* Maintenance

Cleaning

Interior Care	557
Exterior Care	559

Accessories and Modifications

* Not available on all models

Inspection and Maintenance

For your safety, perform all listed inspections and maintenance to keep your vehicle in good condition. If you become aware of any abnormality (noise, smell, insufficient brake fluid, oil residue on the ground, etc.), have your vehicle inspected by a dealer. (Note, however, that service at a dealer is not mandatory to keep your warranties in effect.)

Types of Inspection and Maintenance

■ Daily inspections

Perform inspections before long distance trips, when washing the vehicle, or when refueling.

■ Periodic inspections

- Check the automatic transmission fluid level monthly.
 - **Automatic Transmission Fluid** P. 535
- Check the brake fluid level monthly.
 - **Checking the Brake Fluid** P. 536
- Check the tire pressure monthly. Examine the tread for wear and foreign objects.
 - **Checking and Maintaining Tires** P. 545
- Check the operation of the exterior lights monthly.
 - **Replacing Light Bulbs** P. 537
- Check the condition of the wiper blades at least every six months.
 - **Checking and Maintaining Wiper Blades** P. 543

» Inspection and Maintenance

U.S. models

Maintenance, replacement, or repair of emissions control devices and systems may be done by any automotive repair establishment or individuals using parts that are “certified” to EPA standards.

According to state and federal regulations, failure to perform maintenance on the maintenance main items marked with # will not void your emissions warranties. However, all maintenance services should be performed in accordance with the intervals indicated by the multi-information display.

➤ **Maintenance Service Items** P. 523

If you want to perform complex maintenance tasks that require more skills and tools, you can purchase a subscription to the Service Express website at www.techinfo.honda.com.

➤ **Authorized Manuals** P. 609

If you want to perform maintenance yourself, make sure that you have the necessary tools and skills first. After performing maintenance, update the records in the separate maintenance booklet.

Safety When Performing Maintenance

Some of the most important safety precautions are given here. However, we cannot warn you of every conceivable hazard that can arise in performing maintenance. Only you can decide whether you should perform a given task.

Maintenance Safety

- To reduce the possibility of fire or explosion, keep cigarettes, sparks, and flames away from the battery and all fuel related parts.
- Never leave rags, towels, or other flammable objects under the hood.
 - ▶ Heat from the engine and exhaust can ignite them, causing a fire.
- To clean parts, use a commercially available degreaser or parts cleaner, not gasoline.
- Wear eye protection and protective clothing when working with the battery or compressed air.
- Engine exhaust contains carbon monoxide, which is poisonous and can kill you.
 - ▶ Only operate the engine if there is sufficient ventilation.

Vehicle Safety

- The vehicle must be in a stationary condition.
 - ▶ Make sure your vehicle is parked on level ground, the parking brake is set, and the engine is off.
- Be aware that hot parts can burn you.
 - ▶ Make sure to let the engine and exhaust system cool thoroughly before touching vehicle parts.
- Be aware that moving parts can injure you.
 - ▶ Do not start the engine unless instructed, and keep your hands and limbs away from moving parts.

⚠ Safety When Performing Maintenance

⚠ WARNING

Improperly maintaining this vehicle or failing to correct a problem before driving can cause a crash in which you can be seriously hurt or killed.

Always follow the inspection and maintenance recommendations according to the schedules in this owner's manual.

⚠ WARNING

Failure to properly follow maintenance instructions and precautions can cause you to be seriously hurt or killed.

Always follow the procedures and precautions in this owner's manual.

Parts and Fluids Used in Maintenance Service

The use of Honda genuine parts and fluids is recommended when maintaining and servicing your vehicle. Honda genuine parts are manufactured according to the same high quality standards used in Honda vehicles.

⚠ Parts and Fluids Used in Maintenance Service

Do not press the engine cover forcibly. This may damage the engine cover and component parts.

Maintenance items, which should be serviced at the same time that you replace the engine oil, appear on the multi-information display. You can view them on the engine oil life screen at any time.

To Use Maintenance Minder™

■ Displaying the Maintenance Minder Information

1. Set the power mode to ON.
2. Press the  (Information) button until the engine oil life appears on the multi-information display.

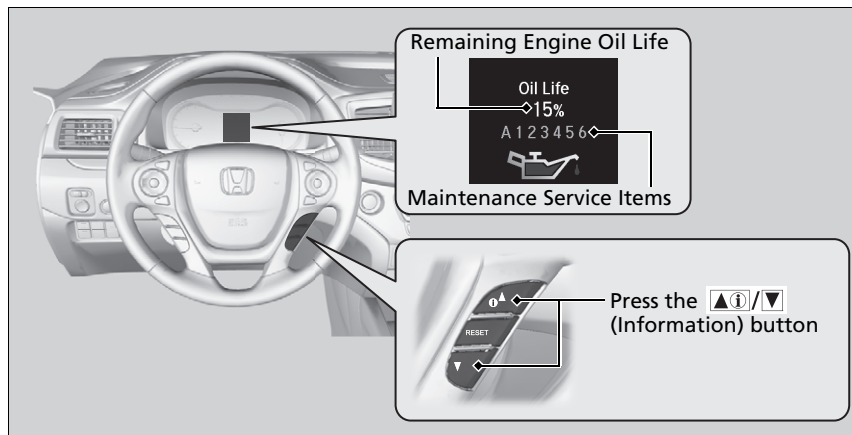

☒ Displaying the Maintenance Minder Information









Based on the engine operating conditions, the remaining engine oil life is calculated and displayed as a percentage.

Displayed Engine Oil Life (%)	Calculated Engine Oil Life (%)
100	100 to 91
90	90 to 81
80	80 to 71
70	70 to 61
60	60 to 51
50	50 to 41
40	40 to 31
30	30 to 21
20	20 to 16
15	15 to 11
10	10 to 6
5	5 to 1
0	0

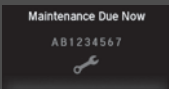
There is a list of maintenance main and sub items you can view on the multi-information display.

☒ **Maintenance Service Items** P. 523

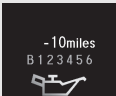
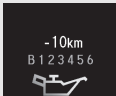
Maintenance Minder Messages on the Multi-Information Display

Maintenance Message	Oil Life Display	Explanation	Information
<p>Maintenance Due Soon</p> 	<p>15%</p> 	<p>The remaining engine oil life is 15 to 6 percent. Once you switch the display by pressing the  (Information) button, this message will go off.</p>	<p>The engine oil is approaching the end of its service life, and the maintenance items should be inspected and serviced soon.</p>
<p>Maintenance Due Now</p> 	<p>5%</p> 	<p>The remaining engine oil life is 5 to 1 percent. Pressing the  (Information) button to switch to another display.</p>	<p>The engine oil has almost reached the end of its service life, and the maintenance items should be inspected and serviced as soon as possible.</p>
<p>Maintenance Past Due</p> 	<p>Negative Distance</p> <p>U.S.</p>  <p>Canada</p> 	<p>The remaining engine oil life has passed its service life, and a negative distance appears after driving over 10 miles (U.S. models) or 10 km (Canadian models). Pressing the  (Information) button to switch to another display.</p>	<p>The engine oil life has passed. The maintenance items must be inspected and serviced immediately.</p>

The system message indicator (i) comes on along with the Maintenance Minder message.

Maintenance Service Items

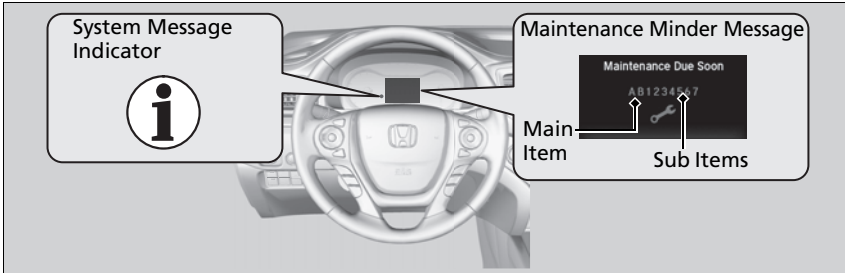

⊠ Maintenance Service Items

- Independent of the maintenance message in the multi-information display, replace the brake fluid every 3 years.
- Adjust the valves during services A, B, 1, 2, or 3 if they are noisy.

CODE	Maintenance Main Items
A	<ul style="list-style-type: none"> • Replace engine oil*¹
B	<ul style="list-style-type: none"> • Replace engine oil*¹ and oil filter • Inspect front and rear brakes • Check parking brake adjustment • Inspect tie rod ends, steering gearbox, and boots • Inspect suspension components • Inspect driveshaft boots • Inspect brake hoses and lines (Including ABS/VA) • Inspect all fluid levels and condition of fluids • Inspect exhaust system[#] • Inspect fuel lines and connections[#]

CODE	Maintenance Sub Items
1	<ul style="list-style-type: none"> • Rotate tires
2	<ul style="list-style-type: none"> • Replace air cleaner element*² • Replace dust and pollen filter*³ • Inspect drive belt
3	<ul style="list-style-type: none"> • Replace transmission fluid and transfer fluid*⁴
4	<ul style="list-style-type: none"> • Replace spark plugs • Replace timing belt and inspect water pump*⁴ • Inspect valve clearance
5	<ul style="list-style-type: none"> • Replace engine coolant
6	<ul style="list-style-type: none"> • Replace rear differential fluid*⁵

*1: If the message **Maintenance Due Now** does not appear more than 12 months after the display is reset, change the engine oil every year.

#: See information on maintenance and emissions warranty in the first column on page 607.

*2: If you drive in dusty conditions, replace the air cleaner element every 15,000 miles (24,000 km).

*3: If you drive primarily in urban areas that have high concentrations of soot in the air from industry and from diesel-powered vehicles, replace every 15,000 miles (24,000 km).

*4: If you drive regularly in very high temperatures (over 110°F, 43°C), in very low temperatures (under -20°F, -29°C), or towing a trailer, replace every 60,000 miles (U.S.) / 100,000 km (Canada).

*5: Driving in mountainous areas at very low vehicle speeds or trailer towing results in higher level of mechanical (Shear) stress to fluid. This requires differential fluid changes more frequently than recommended by the Maintenance Minder. If you regularly drive your vehicle under these conditions, have the differential fluid changed at 7,500 miles (12,000 km), then every 15,000 miles (24,000 km).

Resetting the Display

Models with color audio system

Reset the engine oil life display if you have performed the maintenance service.

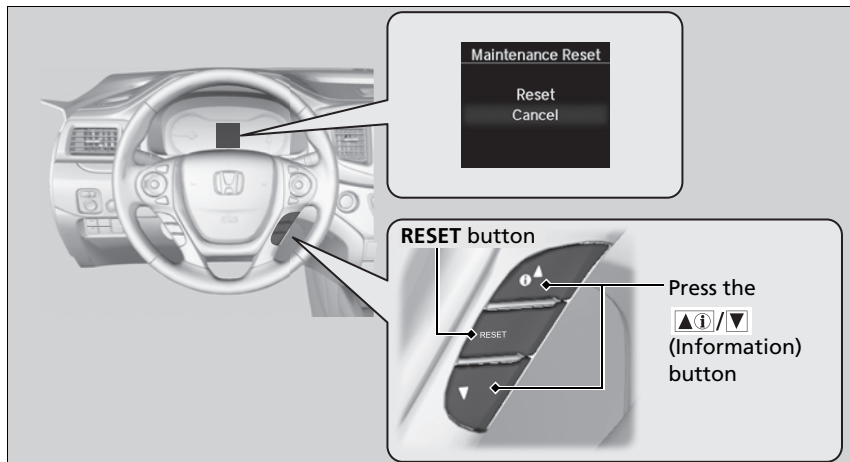

1. Set the power mode to ON.
2. Go to the **Maintenance Info.** group.
 - ▶ **Customized Features** P. 317
3. Press and hold the **RESET** button
 - ▶ The oil life reset mode is displayed on the multi-information display.
4. Select **Reset** with the ▲①/▼ (Information) button, then push the **RESET** button.
 - ▶ The displayed maintenance items disappear, and the engine oil life display returns to **100%**.
 - ▶ To cancel the oil life reset mode, select **Cancel**, then push the **RESET** button.

Resetting the Display

NOTICE

Failure to reset the engine oil life after a maintenance service results in the system showing incorrect maintenance intervals, which can lead to serious mechanical problems.

The dealer will reset the engine oil life display after completing the required maintenance service. If someone other than a dealer performs maintenance service, reset the engine oil life display yourself.

Models with Display Audio

You can reset the engine oil life display using the audio/information screen.

▶ **Customized Features** P. 317

Maintenance Items Under the Hood

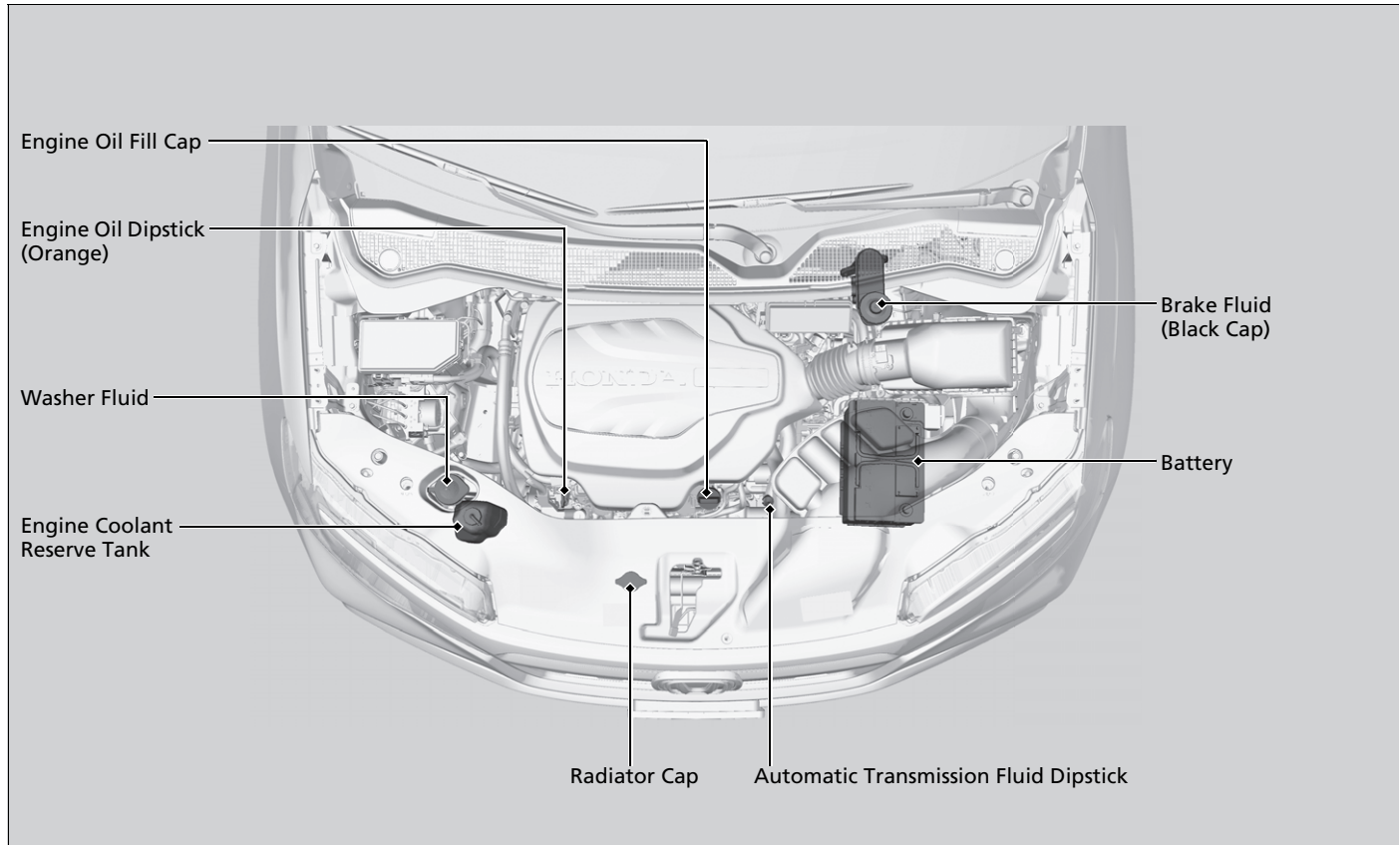

Opening the Hood

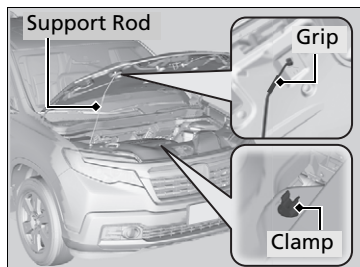
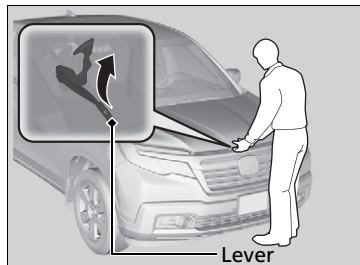
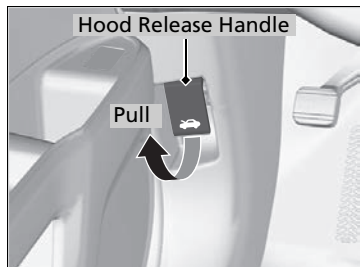

1. Park the vehicle on a level surface, and set the parking brake.
2. Pull the hood release handle under the lower left corner of the dashboard.
 - The hood will pop up slightly.
3. Push up the hood latch lever in the center of the hood to release the lock mechanism, and open the hood.

4. Remove the support rod from the clamp using the grip. Mount the support rod in the hood.

When closing, remove the support rod, and stow it in the clamp, then gently lower the hood. Remove your hand at a height of approximately 12 inches (30 cm) and let the hood close.

►► Opening the Hood

NOTICE

Do not open the hood when the wiper arms are raised: The hood will strike the wipers, and may damage either the hood or the wipers.

When closing the hood, check that the hood is securely latched.

If the hood latch lever moves stiffly, or if you can open the hood without lifting the lever, the latch mechanism should be cleaned and lubricated.

Engine Compartment Cover

The component parts in the engine compartment are protected by a cover. You may need to remove the cover when you perform certain maintenance work. Pull up on the engine compartment cover, remove it from the pins.

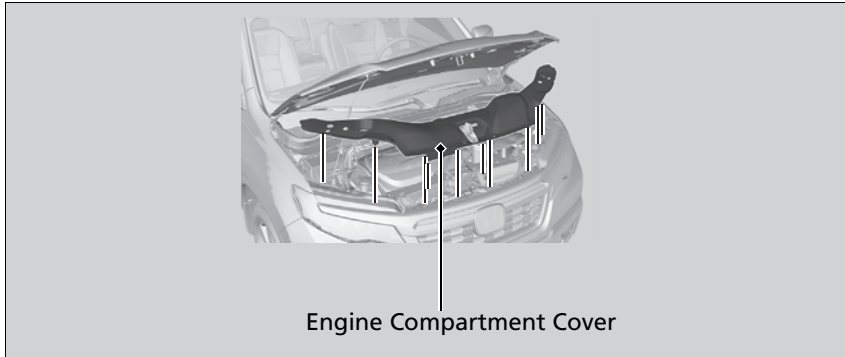

Recommended Engine Oil

- **Genuine Honda Motor Oil**
- **Premium-grade 0W-20 detergent oil with an API Certification Seal on the container.**



Oil is a major contributor to your engine's performance and longevity. If you drive the vehicle with insufficient or deteriorated oil, the engine may fail or be damaged.

This seal indicates the oil is energy conserving and that it meets the American Petroleum Institute's latest requirements.

Use a Genuine Honda Motor Oil or another commercial engine oil of suitable viscosity for the ambient temperature as shown.

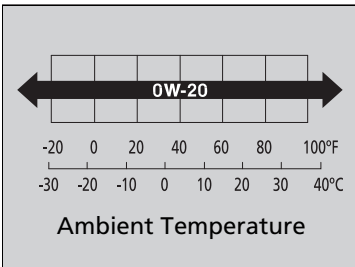

■ Synthetic oil

You may also use synthetic motor oil if it is labeled with the API Certification Seal and is the specified viscosity grade.

►► Recommended Engine Oil

Engine Oil Additives

Your vehicle does not require oil additives. In fact, they may adversely affect the engine performance and durability.

Oil Check

We recommend that you check the engine oil level every time you refuel.

Park the vehicle on level ground.

Wait approximately three minutes after turning the engine off before you check the oil.

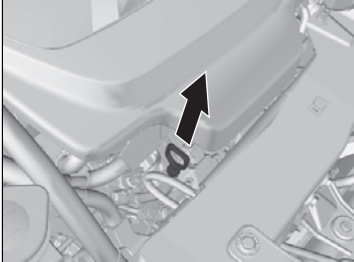

1. Remove the dipstick (orange).
2. Wipe the dipstick with a clean cloth or paper towel.
3. Insert the dipstick back all the way into its hole.

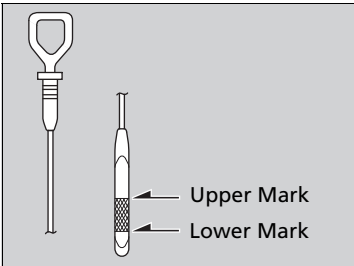

4. Remove the dipstick again, and check the level. It should be between the upper and lower marks. Add oil if necessary.

Oil Check

If the oil level is near or below the lower mark, slowly add oil, being careful not to overfill.

Adding Engine Oil

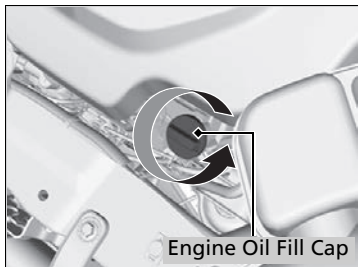

1. Unscrew and remove the engine oil fill cap.
2. Add oil slowly.
3. Reinstall the engine oil fill cap, and tighten it securely.
4. Wait for three minutes and recheck the engine oil dipstick.

▶▶ Adding Engine Oil

NOTICE

Do not fill the engine oil above the upper mark. Overfilling the engine oil can result in leaks and engine damage.

If any oil spills, wipe it away immediately. Spilled oil may damage the engine compartment components.

Changing the Engine Oil and Oil Filter

You must change the engine oil and oil filter regularly in order to maintain the engine's lubrication. The engine may be damaged if they are not changed regularly.

Change the oil and filter in accordance with the maintenance message on the multi-information display.

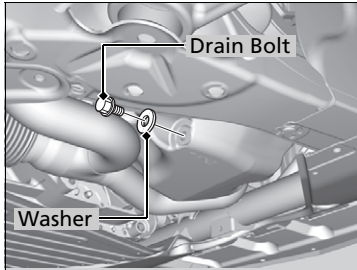

1. Run the engine until it reaches normal operating temperature, and then turn the engine off.
2. Open the hood and remove the engine oil fill cap.
3. Remove the drain bolt and washer from the bottom of the engine, and drain the oil into a suitable container.

Changing the Engine Oil and Oil Filter

NOTICE

You may damage the environment if you do not dispose of the oil in a suitable way. If you are changing the oil by yourself, appropriately dispose of the used oil. Put the oil in a sealed container and take it to a recycling center. Do not throw the oil away into a garbage can or onto the ground.

Continued

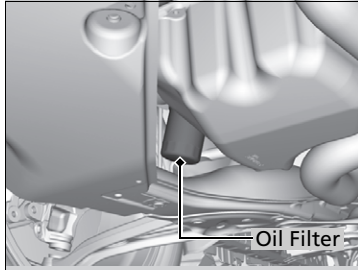

4. Remove the oil filter and dispose of the remaining oil.
5. Check that the filter gasket is not stuck to the engine contact surface.
 - If it is stuck, you must detach it.
6. Wipe away dirt and dust adhering to the contact surface of the oil filter base, and install a new oil filter.
 - Apply a light coat of new engine oil to the oil filter rubber seal.
7. Put a new washer on the drain bolt, then reinstall the drain bolt.
 - Tightening torque:
29 lbf·ft (39 N·m, 4.0 kgf·m)
8. Pour the recommended engine oil into the engine.
 - Engine oil change capacity (including filter):
5.7 US qt (5.4 ℓ)
9. Reinstall the engine oil fill cap securely and start the engine.
10. Run the engine for a few minutes, and then check that there is no leak from the drain bolt or oil filter.
11. Stop the engine, wait for three minutes, and then check the oil level on the dipstick.
 - If necessary, add more engine oil.

✎ Changing the Engine Oil and Oil Filter

You will need a special wrench to replace the oil filter. You can buy this wrench from a dealer.

When installing the new oil filter, follow the instructions supplied with the oil filter.

Reinstall the engine oil fill cap. Start the engine. The low oil pressure indicator should go off within five seconds. If it does not, turn off the engine, and check your work.

Engine Coolant

Specified coolant: Honda Long Life Antifreeze/Coolant Type 2

This coolant is premixed with 50% antifreeze and 50% water. Do not add any straight antifreeze or water.

We recommend you check the engine coolant level every time you refuel. Check the reserve tank first. If it is completely empty, also check the coolant level in the radiator. Add the engine coolant accordingly.

Reserve Tank

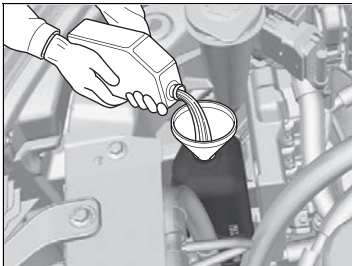
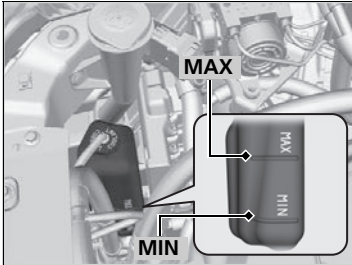

1. Remove the engine compartment cover.
▶ **Engine Compartment Cover** P. 527
2. Check the amount of coolant in the reserve tank.
3. If the coolant level is below the **MIN** mark, add the specified coolant until it reaches the **MAX** mark.
4. Inspect the cooling system for leaks.

Engine Coolant

NOTICE

Genuine Honda engine coolant is a 50/50 mixture of antifreeze and water that can withstand freezing at temperatures as low as about -31°F (-35°C). If your vehicle is consistently subjected to temperatures below this, the concentration of antifreeze in the coolant should be increased. Consult a dealer for details.

If Honda antifreeze/coolant is not available, you may use another major brand non-silicate coolant as a temporary replacement. Check that it is a high quality coolant recommended for aluminum engines. Continued use of any non-Honda coolant can result in corrosion, causing the cooling system to malfunction or fail. Have the cooling system flushed and refilled with Honda antifreeze/coolant as soon as possible.

Do not add rust inhibitors or other additives to your vehicle's cooling system. They may not be compatible with the coolant or with the engine components.

Continued

Radiator

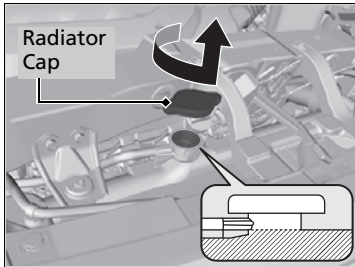

1. Make sure the engine and radiator are cool.
2. Remove the engine compartment cover.
➤ **Engine Compartment Cover** P. 527
3. Turn the radiator cap counterclockwise and relieve any pressure in the cooling system. Do not push the cap down when turning.
4. Push down and turn the radiator cap counterclockwise to remove it.
5. The coolant level should be up to the base of the filler neck. Add coolant if it is low.
6. Put the radiator cap back on, and tighten it fully.
7. Pour coolant into the reserve tank until it reaches the **MAX** mark. Put the cap back on the reserve tank.

Radiator

⚠ WARNING

Removing the radiator cap while the engine is hot can cause the coolant to spray out, seriously scalding you.

Always let the engine and radiator cool down before removing the radiator cap.

NOTICE

Pour the fluid slowly and carefully so you do not spill any. Clean up any spills immediately; they can damage components in the engine compartment.

Transmission Fluid

Automatic Transmission Fluid

Specified fluid: Honda ATF DW-1 (automatic transmission fluid)

Have a dealer check the fluid level and replace if necessary.

Do not attempt to check or change the automatic transmission fluid yourself.

ⓘ Automatic Transmission Fluid

NOTICE

Do not mix Honda ATF DW-1 (automatic transmission fluid) with other transmission fluids.

Using a transmission fluid other than Honda ATF DW-1 may adversely affect the operation and durability of your vehicle's transmission, and damage the transmission.

Any damage caused by using a transmission fluid that is not equivalent to Honda ATF DW-1 is not covered by Honda's new vehicle limited warranty.

Brake Fluid

Specified fluid: Honda Heavy Duty Brake Fluid DOT 3

■ Checking the Brake Fluid

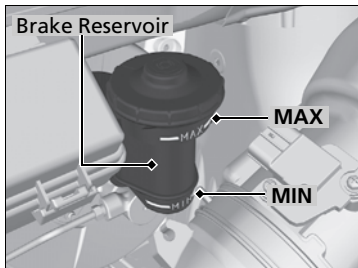

The fluid level should be between the **MIN** and **MAX** marks on the side of the reserve tank.

Refilling Window Washer Fluid

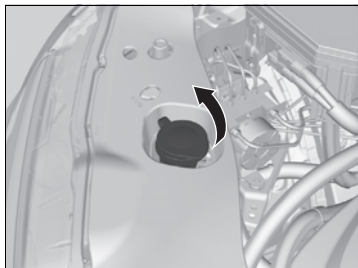

Models without washer level sensor

Check the amount of window washer fluid. If the level is low, fill the washer reservoir.

Models with washer level sensor

If the washer fluid is low, a message appears on the multi-information display.

Pour the washer fluid carefully. Do not overflow the reservoir.

►► Brake Fluid

NOTICE

Brake fluid marked DOT 5 is not compatible with your vehicle's braking system and can cause extensive damage.

If the specified brake fluid is not available, you should use only DOT 3 or DOT 4 fluid from a sealed container as a temporary replacement.

Using any non-Honda brake fluid can cause corrosion and decrease the longevity of the system. Have the brake system flushed and refilled with Honda Heavy Duty Brake Fluid DOT 3 as soon as possible.

If the brake fluid level is at or below the **MIN** mark, have a dealer inspect the vehicle for leaks or worn brake pads as soon as possible.

►► Refilling Window Washer Fluid

NOTICE

Do not use engine antifreeze or a vinegar/water solution in the windshield washer reservoir. Antifreeze can damage your vehicle's paint. A vinegar/water solution can damage the windshield washer pump.

Headlight Bulbs

When replacing, use the following bulbs.

High beam headlight:	60 W (HB3 for halogen bulb type)
Low beam headlight:	Models with Auto high-beam system
	LED type
	Models without Auto high-beam system
	55 W (H11 for halogen bulb type)

High Beam Headlight

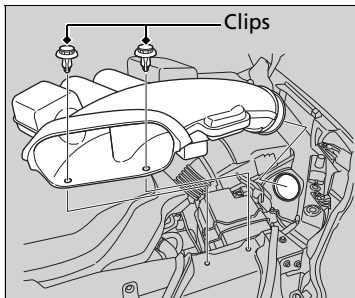

Driver side

1. Remove the engine compartment cover.
➤ **Engine Compartment Cover** P. 527
2. Remove the clips.
3. Remove the air intake duct.

Headlight Bulbs

NOTICE

Halogen bulbs get very hot when lit. Oil, perspiration, or a scratch on the glass can cause the bulb to overheat and shatter.

The headlight aim is set by the factory, and does not need to be adjusted. However, if you regularly carry heavy items in the cargo area, have the aiming readjusted at a dealer or by a qualified technician.

When replacing a halogen bulb, handle it by its base, and protect the glass from contact with your skin or hard objects. If you touch the glass, clean it with denatured alcohol and a clean cloth.

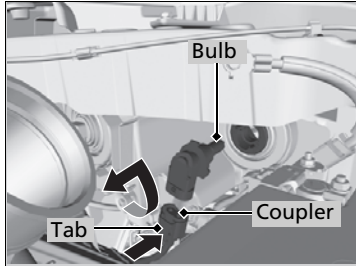

Both sides

4. Push the tab to remove the coupler.
5. Rotate the old bulb counter-clockwise to remove.
6. Insert a new bulb into the headlight assembly and turn it clockwise.
7. Insert the coupler into the connector of the bulb.

►► Headlight Bulbs

Remove clip using phillips head screwdriver.

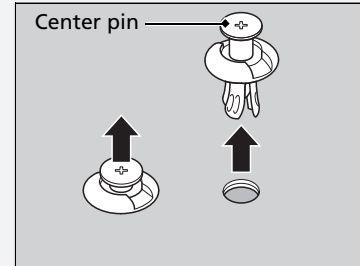

Insert the clip with the central pin raised, and push until it is flat.

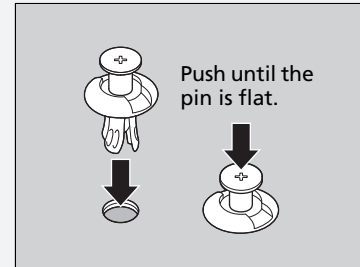

Low Beam Headlights

Models without Auto high-beam

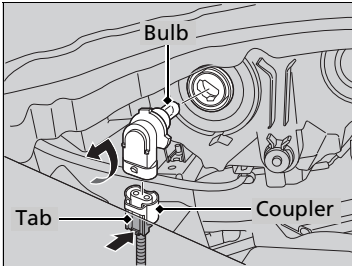

1. Push the tab to remove the coupler.
2. Rotate the old bulb counter-clockwise to remove.
3. Insert a new bulb into the headlight assembly and turn it clockwise.
4. Insert the coupler into the connector of the bulb.

Daytime Running Lights and Parking Lights

Models with LED type daytime running lights

Daytime running lights and parking lights are LED type. Have an authorized Honda dealer inspect and replace the light assembly.

Models without LED type daytime running lights

Daytime running light bulbs and high beam headlight bulbs are the same.

🔧 **Headlight Bulbs** P. 537

Parking light bulbs and front turn signal bulbs are the same.

🔧 **Front Turn Signal/Parking* and Fog* Light Bulbs** P. 540

Front Side Marker Lights

Front side marker lights are LED type. Have an authorized Honda dealer inspect and replace the light assembly.

* Not available on all models

▶▶ Low Beam Headlights

Models with Auto high-beam

Low beam headlights are LED type. Have an authorized Honda dealer inspect and replace the light assembly.

Front Turn Signal/Parking* and Fog* Light Bulbs

When replacing, use the following bulbs.

Front Turn Signal/Parking* Light:	28/8W (Amber)
Fog Light*:	35 W (H8 for halogen bulb type)

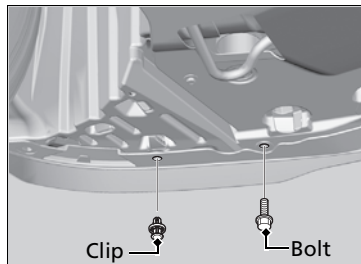

1. Remove the clip using a flat-tip screwdriver, remove the bolt, and push up the under cover.

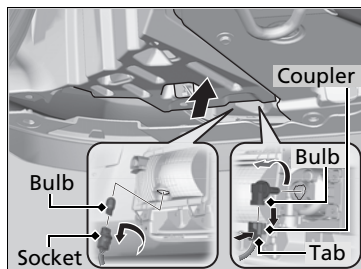

Models with fog light

2. Remove the coupler

All models

3. Turn the socket counter-clockwise and remove it.
4. Remove the old bulb and insert a new bulb.

Side Turn Signal*/Emergency Indicator Lights*

Door mirror side turn lights are LED type. Have an authorized Honda dealer inspect and replace the light assembly.

▶ Front Turn Signal/Parking* and Fog* Light Bulbs

Insert a flat-tip screwdriver, lift and remove the center pin to remove the clip.

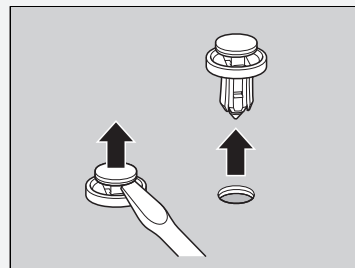

Insert the clip with the center pin raised, and push until it is flat.

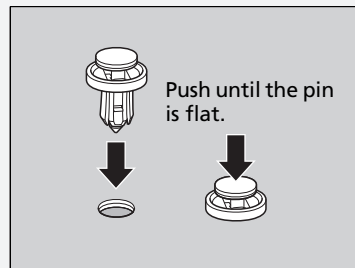

Rear Turn Signal and Back-Up Light Bulbs

When replacing, use the following bulbs.

Back-Up Light:	21 W
Rear Turn Signal Light:	21 W

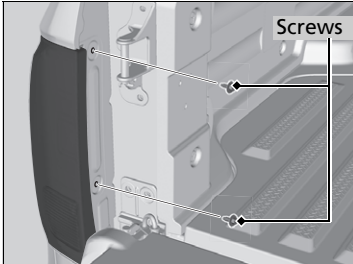

1. Use a Phillip-head screwdriver to remove the screws.
2. Pull the light assembly out of the rear pillar.

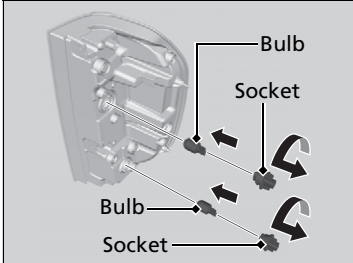

3. Turn the socket counter-clockwise and remove it. Remove the old bulb.
4. Insert a new bulb and turn clockwise.
5. Slide the light assembly onto the guide on the body.
6. Align the pins with the body grommets, then push in until they fully seat.

Brake/Taillight and Rear Side Marker Lights

Brake/taillight and rear side marker lights are LED type. Have an authorized Honda dealer inspect and replace the light assembly.

Rear License Plate Lights

When replacing, use the following bulbs.

Rear License Plate Lights: 5 W



1. Remove the license plate light assembly by pulling it towards you, and then pulling the front edge upward.

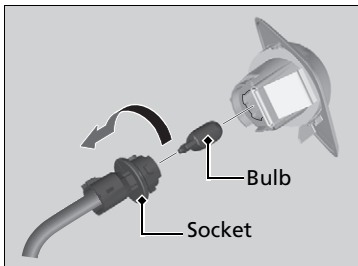

2. Turn the socket counter-clockwise and remove it. Remove the old bulb.
3. Insert a new bulb and turn clockwise.

High-Mount Brake Light

High-mount brake light is LED type. Have an authorized Honda dealer inspect and replace the light assembly.

Checking Wiper Blades

If the wiper blade rubber has deteriorated, it will leave streaks and the hard surfaces of the blade may scratch the window glass.

Changing the Wiper Blade Rubber

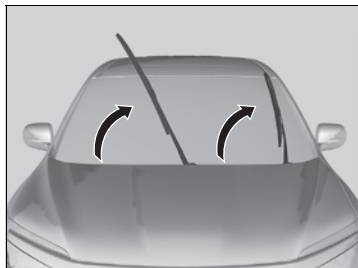

1. Lift the driver side wiper arm first, then the passenger side.

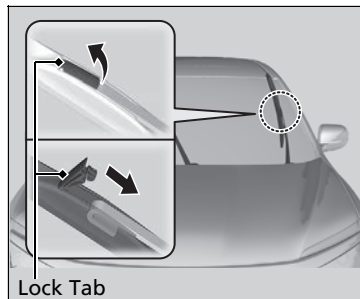

2. Using a flat-tip screwdriver, pry up on the edge of the lock tab to release it. Wrap the flat-tip screwdriver with a cloth to prevent scratches. Slide the blade off of the wiper arm.

Changing the Wiper Blade Rubber

NOTICE

Avoid dropping the wiper arm; it may damage the windshield.

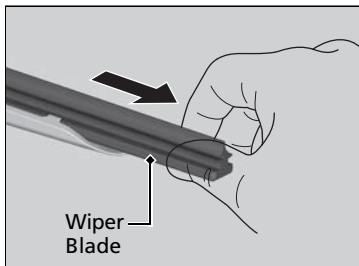

3. Slide the wiper blade out from its holder by pulling the tabbed end out.

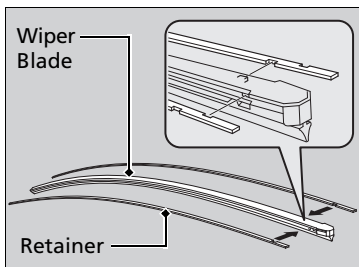

4. Remove the retainers from the wiper blade that has been removed, and mount to a new wiper blade.
 - ▶ Correctly align the wiper blade protrusion and the retainer grooves.

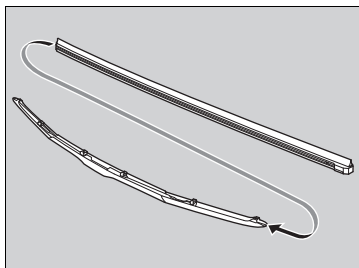

5. Slide the new wiper blade onto the holder from the bottom end.
 - ▶ The tab on the holder should fit in the indent of the wiper blade.
6. Slide the wiper blade onto the wiper arm, then push down the lock tab.
7. Lower the passenger side wiper arm first, then the driver side.

Checking Tires

To safely operate your vehicle, your tires must be of the proper type and size, in good condition with adequate tread, and properly inflated.

■ Inflation guidelines

Properly inflated tires provide the best combination of handling, tread life, and comfort. Refer to the driver's doorjamb label or specification's page for the specified pressure.

Underinflated tires wear unevenly, adversely affect handling and fuel economy, and are more likely to fail from overheating.

Overinflated tires make your vehicle ride harshly, are more prone to road hazards, and wear unevenly.

Every day before you drive, look at each of the tires. If one looks lower than the others, check the pressure with a tire gauge.

At least once a month or before long trips, use a gauge to measure the pressure in all tires, including the spare. Even tires in good condition can lose 1-2 psi (10-20 kPa, 0.1-0.2 kgf/cm²) per month.

■ Inspection guidelines

Every time you check inflation, also examine the tires and valve stems. Look for:

- Bumps or bulges on the side or in the tread. Replace the tire if you find any cuts, splits, or cracks in the side of the tire. Replace it if you see fabric or cord.
- Remove any foreign objects and inspect for air leaks.
- Uneven tread wear. Have a dealer check the wheel alignment.
- Excessive tread wear.
 - **Wear Indicators** P. 550
- Cracks or other damage around valve stem.

☒ Checking Tires

⚠ WARNING

Using tires that are excessively worn or improperly inflated can cause a crash in which you can be seriously hurt or killed.

Follow all instructions in this owner's manual regarding tire inflation and maintenance.

Measure the air pressure when tires are cold. This means the vehicle has been parked for at least three hours, or driven less than 1 mile (1.6 km). If necessary, add or release air until the specified pressure is reached.

If checked when hot, tire pressure can be as much as 4-6 psi (30-40 kPa, 0.3-0.4 kgf/cm²) higher than if checked when cold.

Whenever tire pressure is adjusted, you must calibrate the TPMS.

➤ **TPMS with Tire Fill Assist** P. 480

Have a dealer check the tires if you feel a consistent vibration while driving. New tires and any that have been removed and reinstalled should be properly balanced.

Check the spare tire pressure once a month or before long trips.

Tire and Loading Information Label

The label attached to the driver's doorjamb provides necessary tire and loading information.

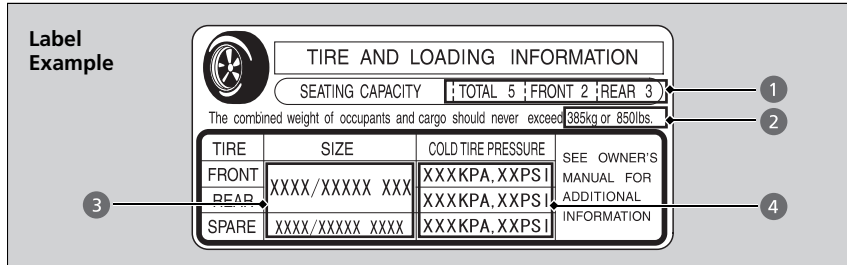

▶▶ Tire and Loading Information Label

The tire and loading information label attached to the driver's doorjamb contains:

- 1 The number of people your vehicle can carry.
- 2 The total weight your vehicle can carry. Do not exceed this weight.
- 3 The original tire sizes for front, rear, and spare.
- 4 The proper cold tire pressure for front, rear, and spare.

Tire Labeling

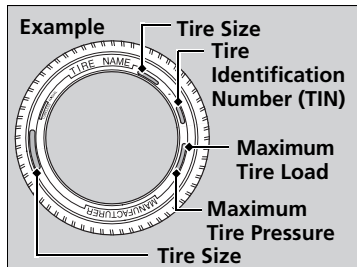

The tires that came on your vehicle have a number of markings. Those you should be aware of are described below.

▶▶ Tire Sizes

Following is an example of tire size with an explanation of what each component means.

P235/60R18 102V

P: Vehicle type (P indicates passenger vehicle).

235: Tire width in millimeters.

60: Aspect ratio (the tire's section height as a percentage of its width).

R: Tire construction code (R indicates radial).

18: Rim diameter in inches.

102: Load index (a numerical code associated with the maximum load the tire can carry).

V: Speed symbol (an alphabetical code indicating the maximum speed rating).

Tire Sizes

Whenever tires are replaced, they should be replaced with tires of the same size.

■ Tire Identification Number (TIN)

The tire identification number (TIN) is a group of numbers and letters that look like the example in the side column. TIN is located on the sidewall of the tire.

■ Glossary of Tire Terminology

Cold Tire Pressure – The tire air pressure when the vehicle has been parked for at least three hours or driven less than 1 mile (1.6 km).

Load Rating – Means the maximum load that a tire is rated to carry for a given inflation pressure.

Maximum Inflation Pressure – The maximum tire air pressure that the tire can hold.

Maximum Load Rating – Means the load rating for a tire at the maximum permissible inflation pressure for that tire.

Recommended Inflation Pressure – The cold tire inflation pressure recommended by the manufacturer.

Treadwear Indicators (TWI) – Means the projections within the principal grooves designed to give a visual indication of the degrees of wear of the tread.

☒ Tire Identification Number (TIN)

DOT B97R FW6X 2209

DOT: This indicates that the tire meets all requirements of the U.S. Department of Transportation.

B97R: Manufacturer's identification mark.

FW6X: Tire type code.

22 09: Date of manufacture.

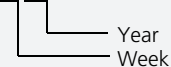

DOT Tire Quality Grading (U.S. Vehicles)

The tires on your vehicle meet all U.S. Federal Safety Requirements. All tires are also graded for treadwear, traction, and temperature performance according to Department of Transportation (DOT) standards. The following explains these gradings.

■ Uniform Tire Quality Grading

Quality grades can be found where applicable on the tire sidewall between tread shoulder and maximum section width.

■ Treadwear

The treadwear grade is a comparative rating based on the wear rate of the tire when tested under controlled conditions on a specified government test course. For example, a tire graded 150 would wear one and one-half (1 1/2) times as well on the government course as a tire graded 100. The relative performance of tires depends upon the actual conditions of their use, however, and may depart significantly from the norm due to variations in driving habits, service practices and differences in road characteristics and climate.

▶▶ Uniform Tire Quality Grading

For example:
Treadwear 200
Traction AA
Temperature A

All passenger car tires must conform to Federal Safety Requirements in addition to these grades.

■ Traction

The traction grades, from highest to lowest, are AA, A, B, and C. Those grades represent the tire's ability to stop on wet pavement as measured under controlled conditions on specified government test surfaces of asphalt and concrete. A tire marked C may have poor traction performance.

■ Temperature

The temperature grades are A (the highest), B, and C, representing the tire's resistance to the generation of heat and its ability to dissipate heat when tested under controlled conditions on a specified indoor laboratory test wheel. Sustained high temperature can cause the material of the tire to degenerate and reduce tire life, and excessive temperature can lead to sudden tire failure. The grade C corresponds to a level of performance which all passenger car tires must meet under the Federal Motor Vehicle Safety Standard No. 109. Grades B and A represent higher levels of performance on the laboratory test wheel than the minimum required by law.

⌘ Traction

Warning: The traction grade assigned to this tire is based on straight-ahead braking traction tests, and does not include acceleration, cornering, hydroplaning, or peak traction characteristics.

⌘ Temperature

Warning: The temperature grade for this tire is established for a tire that is properly inflated and not overloaded. Excessive speed, underinflation, or excessive loading, either separately or in combination, can cause heat buildup and possible tire failure.

Wear Indicators

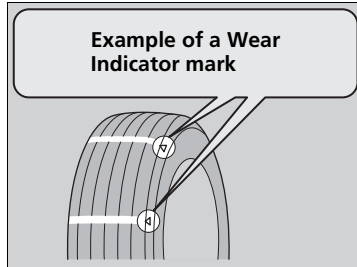

The groove where the wear indicator is located is 1/16 inch (1.6 mm) shallower than elsewhere on the tire. If the tread has worn so that the indicator is exposed, replace the tire.

Worn out tires have poor traction on wet roads.

Tire Service Life

The life of your tires is dependent on many factors, including driving habits, road conditions, vehicle loading, inflation pressure, maintenance history, speed, and environmental conditions (even when the tires are not in use).

In addition to regular inspections and inflation pressure maintenance, it is recommended that you have annual inspections performed once the tires reach five years old. All tires, including the spare, should be removed from service after 10 years from the date of manufacture, regardless of their condition or state of wear.

Tire and Wheel Replacement

Replace your tires with radials of the same size, load range, speed rating, and maximum cold tire pressure rating (as shown on the tire's sidewall). Using tires of a different size or construction can cause the Vehicle Stability Assist (VSA®), hill start assist, and the all-wheel drive (AWD)* systems as well as ABS to work incorrectly.

It is best to replace all four tires at the same time. If that isn't possible, replace the front or rear tires in pairs.

If you replace a wheel, only use TPMS specified wheels approved for your vehicle.

Make sure that the wheel's specifications match those of the original wheels.

ⓘ Tire and Wheel Replacement

⚠ WARNING

Installing improper tires on your vehicle can affect handling and stability. This can cause a crash in which you can be seriously hurt or killed.

Always use the size and type of tires recommended in this owner's manual.

* Not available on all models

Tire Rotation

Rotating tires according to the maintenance messages on the multi-information display helps to distribute wear more evenly and increase tire life.

■ Tires without rotation marks

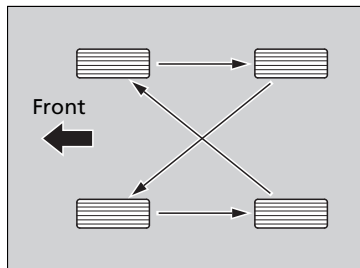

Rotate the tires as shown here.

■ Tires with rotation marks

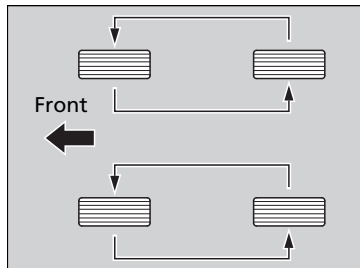

Rotate the tires as shown here.

▶▶ Tire Rotation

Tires with directional tread patterns should only be rotated front to back (not from one side to the other). Directional tires should be mounted with the rotation indication mark facing forward, as shown below.

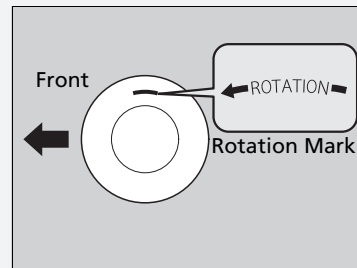

Whenever tires are rotated, you must calibrate TPMS.

▶▶ **TPMS with Tire Fill Assist** P. 480

Winter Tires

If driving on snowy or frozen roads, mount all season marked "M+S" tires, snow tires, or tire chains; reduce speed; and maintain sufficient distance between vehicles when driving.

Be particularly careful when operating the steering wheel or brakes to prevent skidding.

Use tire chains, snow tires, or all season tires when necessary or according to the law.

When mounting, refer to the following points.

For winter tires:

- Select the size and load ranges that are the same as the original tires.
- Mount the tires to all four wheels.

For tire chains:

- Install them on the front tires only.
- Because your vehicle has limited tire clearance, we strongly recommend using the chains listed below:

Cable-type: SCC Super Z LT-ZT735

- Follow the chain manufacturer's instruction when installing. Mount them as tightly as you can.
- Check that the chains do not touch the brake lines or suspension.
- Drive slowly.

❗ Winter Tires

⚠ WARNING

Using the wrong chains, or not properly installing chains, can damage the brake lines and cause a crash in which you can be seriously injured or killed.

Follow all instructions in this owner's manual regarding the selection and use of tire chains.

NOTICE

Traction devices that are the wrong size or improperly installed can damage your vehicle's brake lines, suspension, body, and wheels. Stop driving if they are hitting any part of the vehicle.

When tire chains are mounted, follow the chain manufacturer's instructions regarding vehicle operational limits.

If your vehicle is equipped with summer tires, be aware that these tires are not designed for winter driving conditions. For more information, contact a dealer.

Checking the Battery

The condition of the battery is monitored by a sensor located on the negative terminal of the battery. If there is a problem with this sensor, the multi-information display will display a warning message. If this happens, have your vehicle inspected by a dealer.

Check the battery terminals for corrosion monthly.

If your vehicle's battery is disconnected or goes dead:

- The audio system is disabled.
 - **Audio System Theft Protection** P. 203

Models without navigation system

- The clock resets.
 - **Clock** P. 110

Charging the Battery

Disconnect both battery cables to prevent damaging your vehicle's electrical system. Always disconnect the negative (-) cable first, and reconnect it last.

ⓘ Battery

WARNING

The battery gives off explosive hydrogen gas during normal operation.

A spark or flame can cause the battery to explode with enough force to kill or seriously hurt you.

When conducting any battery maintenance, wear protective clothing and a face shield, or have a skilled technician do it.

WARNING: Battery post, terminals, and related accessories contain lead and lead compounds.
Wash your hands after handling.

If you find corrosion, clean the battery terminals by applying a baking powder and water solution. Clean the terminals with a damp towel. Cloth/towel dry the battery. Coat the terminals with grease to help prevent future corrosion.

Replacing the Button Battery

If the indicator does not come on when the button is pressed, replace the battery.

Smart Entry Remote

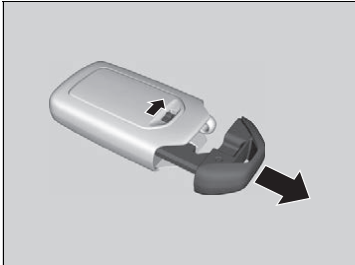

Battery type: CR2032

1. Remove the built-in key.
2. Remove the upper half of the cover by carefully prying on the edge with a coin.
 - ▶ Remove carefully to avoid losing the buttons.
 - ▶ Wrap a coin with a cloth to prevent scratching the smart entry remote.
3. Make sure to replace the battery with the correct polarity.

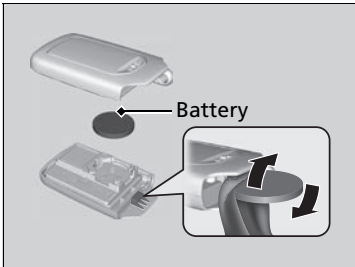

Replacing the Button Battery

⚠ WARNING

CHEMICAL BURN HAZARD

The battery that powers the remote transmitter can cause severe internal burns and can even lead to death if swallowed. Keep new and used batteries away from children.

If you suspect that a child has swallowed the battery, seek medical attention immediately.

NOTICE

An improperly disposed of battery can damage the environment. Always confirm local regulations for battery disposal.

Replacement batteries are commercially available or at a dealer.

Air Conditioning

To ensure proper and safe operation, the Society of Automotive Engineers (SAE J2845) recommends that the refrigerant system only be serviced by trained and certified technicians.

Never repair or replace the air conditioning evaporator (cooling coil) with one removed from a used or salvaged vehicle.

New replacement mobile air conditioning evaporators must be certified (and labeled) as meeting SAE Standard J2842.

▶▶ Heating and Cooling System*/Climate Control System* Maintenance

NOTICE

Vented refrigerant is harmful to the environment. To avoid refrigerant from venting, never replace the evaporator with one removed from a used or salvaged vehicle.

Refrigerant in your vehicle's air conditioning system is flammable and can be ignited during servicing if proper procedures are not followed.

Air Conditioner label is found under the hood:

➔ **Safety Labels** P. 71

➔ **Specifications** P. 600

Canadian models



⚠ : Caution

🔥 : Flammable Refrigerant

👤 : Requires Registered Technician to Service

⚙ : Air Conditioning System

▶▶ Dust and Pollen Filter

If the airflow from the heating and cooling system*/climate control system* deteriorates noticeably, and the windows fog up easily, the filter may need to be replaced. Please contact a dealer for replacement.

Dust and Pollen Filter

The heating and cooling system*/climate control system* is equipped with a dust and pollen filter that collects pollen, dust, and other debris in the air. The Maintenance Minder™ messages will let you know when to replace the filter.

We recommend that you replace the dust and pollen filter sooner when using your vehicle in areas with high concentrations of dust.

Interior Care

Use a damp cloth with a mixture of mild detergent and warm water to remove dirt. Use a clean cloth to remove detergent residue.

Cleaning Seat Belts

Use a soft brush with a mixture of mild soap and warm water to clean the seat belts. Let the belts air dry. Wipe the openings of the seat belt anchors using a clean cloth.

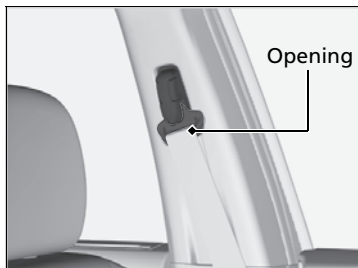

Cleaning the Window

Wipe using a glass cleaner.

Interior Care

Do not spill liquids inside the vehicle. Electrical devices and systems may malfunction if liquids are splashed on them.

Do not use silicone based sprays on electrical devices such as audio devices and switches. Doing so may cause the items to malfunction or a fire inside the vehicle. If a silicone based spray is inadvertently used on electrical devices, consult a dealer.

Depending on their composition, chemicals and liquid aromatics may cause discoloration, wrinkles, and cracking to resin-based parts and textiles. Do not use alkali solvents or organic solvents such as benzene or gasoline.

After using chemicals, make sure to gently wipe them away using a dry cloth. Do not place used cloths on top of resin based parts or textiles for long periods of time without washing.

Cleaning the Window

Wires are mounted to the inside of the rear window. Wipe along the same direction as the wires with a soft cloth so as not to damage them.

■ Floor Mats

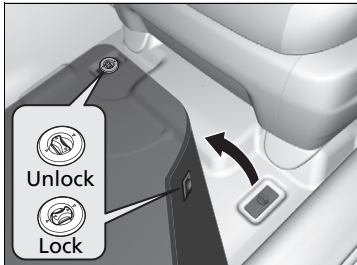

The front and rear seat floor mats hook over the floor anchors, which keep mats from sliding forward. To remove a mat for cleaning, turn the anchor knobs to the unlock position. When reinstalling the mat after cleaning, turn the knobs to the lock position.

Do not put additional floor mats on top of the anchored mats.

■ Maintaining Genuine Leather*

Vacuum dirt and dust from the leather frequently. Pay close attention to the pleats and seams. Clean the leather with a soft cloth dampened with a 90% water and 10% neutral soap solution. Then buff it with a clean, dry cloth. Remove any dust or dirt on leather surfaces immediately.

▣ Floor Mats

If you use any floor mats that were not originally provided with your vehicle, make sure they are designed for your specific vehicle, fit correctly, and are securely anchored by the floor anchors. Position the rear seat floor mat properly. If they are not properly positioned, the floor mats can interfere with the front seat functions.

Exterior Care

Dust off the vehicle body after you drive.

Regularly inspect your vehicle for scratches on painted surfaces. A scratch on a painted surface can result in body rust. If you find a scratch, promptly repair it.

■ Washing the Vehicle

Wash the vehicle regularly. Wash more frequently when driving in the following conditions:

- If driving on roads with road salt.
- If driving in coastal areas.
- If tar, soot, bird droppings, insects, or tree sap are stuck to painted surfaces.

■ Washing the Trunk

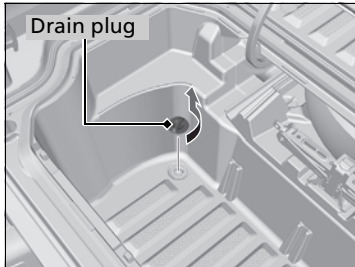

Use a water and mild detergent solution, and a soft brush or cloth to clean the inside of the trunk.

To drain water from the trunk, remove the drain plug by turning it counter-clockwise.

- ▶ When you are finished washing the trunk, dry it with a soft cloth, and reinstall the drain plug.

▶▶ Washing the Vehicle

Do not spray water into the air intake vents or engine compartment. It can cause a malfunction.

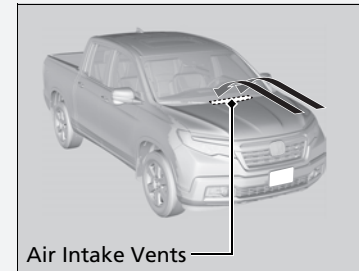

Do not spray water on to the capless unit when the fuel fill door is open. It can cause damage to the fuel system or engine.

■ Using an Automated Car Wash

- Make sure to follow the instructions indicated on the automated car wash.
- Fold in the door mirrors.
- Automatic intermittent wipers* equipment vehicles, wipers switch to OFF.

■ Using High Pressure Cleaners

- Keep sufficient distance between the cleaning nozzle and the vehicle body.
- Take particular care around the windows. Standing too close may cause water to enter the vehicle interior.
- Do not spray high pressure water directly into the engine compartment. Instead, use low pressure water and a mild detergent.

■ Applying Wax

A good coat of automotive body wax helps protect your vehicle's paint from the elements. Wax will wear off over time and expose your vehicle's paint to the elements, so reapply as necessary.

►► Applying Wax

NOTICE

Chemical solvents and strong cleaners can damage the paint, metal, and plastic on your vehicle. Wipe away spills immediately.

■ Maintaining the Bumpers and Other Resin Coated Parts

If you get gasoline, oil, engine coolant, or battery fluid on resin coated parts, they may be stained or the coating may peel. Promptly wipe it away using a soft cloth and clean water.

■ Cleaning the Window

Wipe using a glass cleaner.

■ Maintaining Aluminum Wheels

Aluminum is susceptible to deterioration caused by salt and other road contaminants. Use a sponge and mild detergent to wipe away promptly. Be careful not to use harsh chemicals (including some commercial wheel cleaners) or a stiff brush. They can damage the clear coat of the aluminum alloy wheels that help keep the aluminum from corroding and tarnishing.

▣ Maintaining the Bumpers and Other Resin Coated Parts

Ask a dealer about the correct coating material when you want to repair the painted surface of the parts made of resin.

■ Fogged Exterior Light Lenses

The inside lenses of exterior lights (headlights, brake lights, etc.) may fog temporarily if you have driven in the rain, or after the vehicle has been run through a car wash. Dew condensation also may build up inside the lenses when there is a significant enough difference between the ambient and inside lens temperatures (similar to vehicle windows fogging up in rainy conditions). These conditions are natural processes, not structural design problems in the exterior lights.

Lens design characteristics may result in moisture developing on the light lens frame surfaces. This also is not a malfunction.

However, if you see large amounts of water accumulation, or large water drops building up inside the lenses, have your vehicle inspected by a dealer.

Accessories

When installing accessories, check the following:

- Do not install accessories on the windshield. They can obstruct your view and delay your reaction to driving conditions.
- Do not install any accessories over areas marked SRS Airbag, on the sides or backs of the front seats, on front or side pillars, or near the side windows. Accessories installed in these areas may interfere with proper operation of the vehicle's airbags or may be propelled into you or another occupant if the airbags deploy.
- Be sure electronic accessories do not overload electrical circuits or interfere with proper operation of your vehicle.
 - **Fuses** P. 589
- Before installing any electronic accessory, have the installer contact a dealer for assistance. If possible, have a dealer inspect the final installation.
- Your vehicle should not be used to carry a slide-in camper. If you install a truck cap, be sure it is properly installed and does not exceed your vehicle's load limits.
 - **Maximum Load Limit** P. 413

Accessories and Modifications

⚠ WARNING

Improper accessories or modifications can affect your vehicle's handling, stability, and performance, and cause a crash in which you can be seriously hurt or killed.

Follow all instructions in this owner's manual regarding accessories and modifications.

Honda Genuine accessories are recommended to ensure proper operation on your vehicle.

Modifications

Do not modify your vehicle in a manner that may affect its handling, stability, or reliability, or install non-genuine Honda parts or accessories that may have a similar effect.

Even minor modifications to vehicle systems can affect overall vehicle performance. Always make sure all equipment is properly installed and maintained, and do not make any modification to your vehicle or its systems that might cause your vehicle to no longer meet federal, state, province, territory, and local regulations.

The on-board diagnostic port (OBD-II/SAE J1962 connector) installed on this vehicle is intended to be used with automobile system diagnostic devices or with other devices that Honda has approved. Use of any other type of device may adversely affect the vehicle's electronic systems or allow them to be compromised, possibly resulting in a system malfunction, drained battery, or other unexpected problems.

Do not modify or attempt to repair any of the electrical components.

Handling the Unexpected

This chapter explains how to handle unexpected troubles.

Tools

Types of Tools 566

If a Tire Goes Flat

Changing a Flat Tire 567

Engine Does Not Start

Checking the Engine 576

If the Smart Entry Remote Battery is Weak 577

Emergency Engine Stop 578

Jump Starting 579

Shift Lever Does Not Move 582

Overheating

How to Handle Overheating 583

Indicator, Coming On/Blinking

If the Low Oil Pressure Indicator Comes On 585

If the Charging System Indicator Comes On 585

If the Malfunction Indicator Lamp Comes On or Blinks 586

If the Brake System Indicator (Red) Comes On 587

If the Electric Power Steering (EPS) System Indicator Comes On 587

If the Low Tire Pressure/Tire Pressure Monitoring System (TPMS) Indicator Comes On or Blinks 588

Fuses

Fuse Locations 589

Inspecting and Changing Fuses 593

Emergency Towing 594

When You Cannot Unlock the Fuel Fill Door 595

Refueling

Refueling From a Portable Fuel Container 596

Types of Tools

Types of Tools

The tools are stored in the trunk.

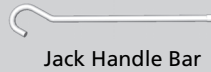
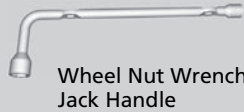
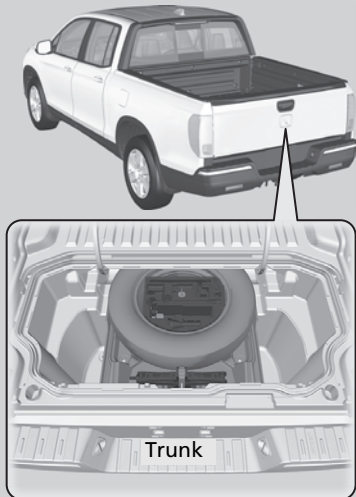

Changing a Flat Tire

If a tire goes flat while driving, grasp the steering wheel firmly, and brake gradually to reduce speed. Then, stop in a safe place. Replace the flat tire with a compact spare tire. Go to a dealer as soon as possible to have the full-size tire repaired or replaced.

1. Park the vehicle on firm, level, non-slippery surface and apply the parking brake.
2. Move the shift lever to **P**.
3. Turn on the hazard warning lights and set the power mode to VEHICLE OFF (LOCK).

✘ Changing a Flat Tire

Follow compact spare precautions:

Periodically check the tire pressure of the compact spare. It should be set to the specified pressure.
Specified Pressure: 60 psi (420 kPa, 4.2 kgf/cm²)

When driving with the compact spare tire, keep the vehicle speed under 50 mph (80 km/h). Replace with a full-size tire as soon as possible.

The compact spare tire and wheel in your vehicle are specifically for this model. Do not use them with another vehicle. Do not use another type of compact spare tire or wheel with your vehicle.

Do not mount tire chains on a compact spare tire. If a chain-mounted front tire goes flat, remove one of the full-size rear tires and replace it with the compact spare tire. Remove the flat front tire and replace it with the full-size tire that was removed from the rear. Mount the tire chains on the front tire.

Do not use a puncture-repairing agent on a flat tire, as it can damage the tire pressure sensor.

■ Getting Ready to Replace the Flat Tire

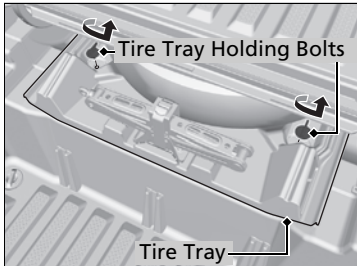

1. Open the trunk.
2. Remove the two tire tray holding bolts.

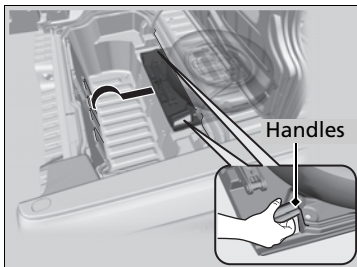

3. Pull out the tire tray with the handles, and hook the rear of the tire tray to the guides on the back edge of the trunk.

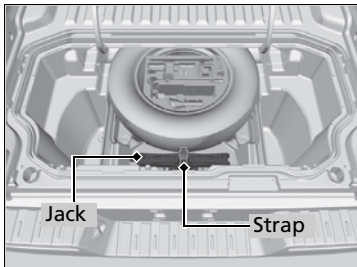

4. Loosen the strap, then take the jack out.

▶▶ Changing a Flat Tire

NOTICE

Do not use the jack if it doesn't work properly. Call your dealer or a professional towing service.

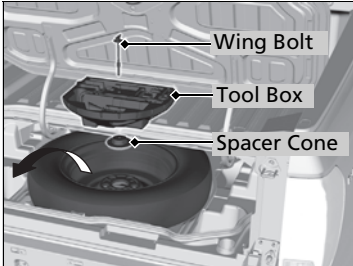

5. Unscrew the wing bolt, and remove the tool box and the spacer cone. Then, remove the compact spare tire.

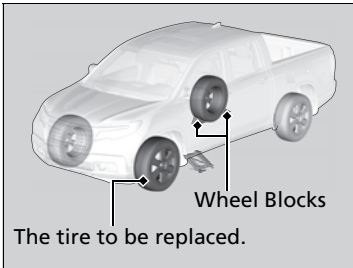

6. Place a wheel block or rock in front and rear of the wheel diagonal to the flat tire.

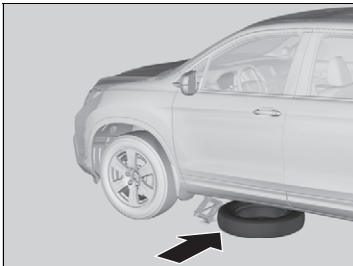

7. Place the compact spare tire, wheel side up under the vehicle body, near the tire that needs to be replaced.



8. Loosen each wheel nut about one turn using the wheel nut wrench.

How to Set Up the Jack

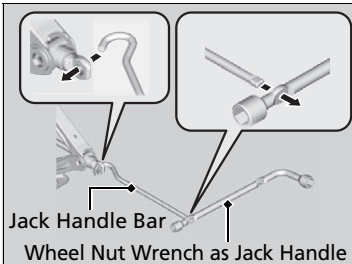
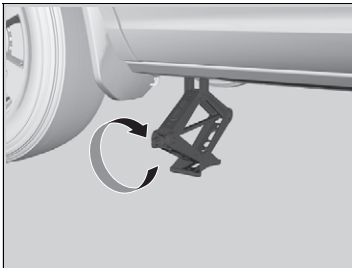
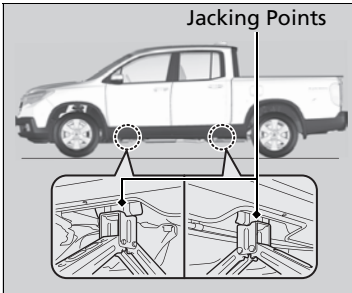

1. Place the jack under the jacking point closest to the tire to be changed.

2. Turn the end bracket clockwise as shown in the image until the top of the jack contacts the jacking point.

▶ Make sure that the jacking point tab is resting in the jack notch.

3. Raise the vehicle, using the jack handle bar and the jack handle, until the tire is off the ground.

How to Set Up the Jack

⚠ WARNING

The vehicle can easily roll off the jack, seriously injuring anyone underneath.

Follow the directions for changing a tire exactly, and never get under the vehicle when it is supported only by the jack.

Do not use the jack with people or luggage in the vehicle.

Use the jack provided in your vehicle. Other jacks may not support the weight ("load") or their shape may not match.

The following instructions must be followed to use the jack safely:

- Do not use while the engine is running.
- Use only where the ground is firm and level.
- Use only at the jacking points.
- Do not get in the vehicle while using the jack.
- Do not put anything on top of or underneath the jack.

■ Replacing the Flat Tire

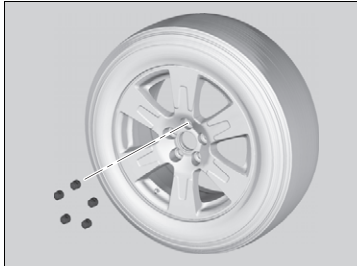

1. Remove the wheel nuts and flat tire.

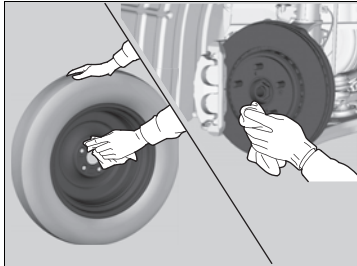

2. Wipe the mounting surfaces of the wheel with a clean cloth.

3. Mount the compact spare tire.

4. Screw the wheel nuts until they touch the lips around the mounting holes, then stop rotating.

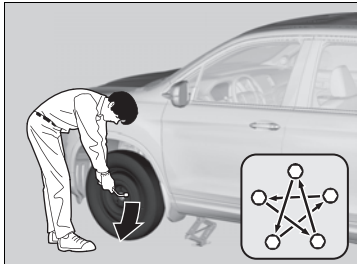

5. Lower the vehicle and remove the jack. Tighten the wheel nuts in the order indicated in the image. Go around, tightening the nuts, two to three times in this order.

Wheel nut torque:

94 lbf·ft (127 N·m, 13 kgf·m)

▶▶ Replacing the Flat Tire

Do not over tighten the wheel nuts by applying extra torque using your foot or a pipe.

■ Securing the Flat Tire on the Pickup Bed

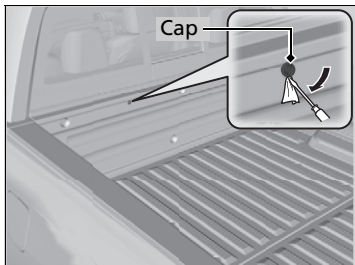

1. Wrap a cloth around the tip of a small flat-tip screwdriver. Put it into the cap as shown in the image, and remove the cap.
2. Remove the center cap and place the tire on the pickup bed.

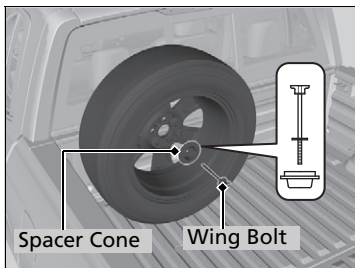

3. Place the spacer cone onto the wheel hub, then secure the flat tire to the pickup bed with the wing bolt as shown.
4. Securely store the jack on the tire tray using the strap.
5. Release the tire tray and slide it back in place.
6. Tighten the tire tray holding bolts securely.
7. Store the center cap and the tool box in the trunk.
 - ▶ Make sure it does not get scratched or damaged.

If you remove the tire from the pickup bed, reinstall the cap to its original location.

▣ Securing the Flat Tire on the Pickup Bed

⚠ WARNING

Loose items can be thrown out of the vehicle in a crash and could seriously injure the occupants.

Store the wheel, jack, and tools securely before driving.

■ Securing a Compact Spare Tire on the Pickup Bed

As a temporary mounting location, you may secure the compact spare tire on the pickup bed, if needed.

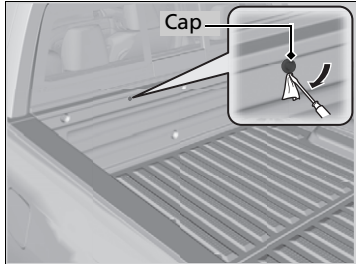

1. Wrap a cloth around the tip of a small flat-tip screwdriver. Put it into the cap as shown in the image, and remove the cap.
2. Remove the compact spare tire from the tire tray.

■ Getting Ready to Replace the Flat Tire P. 568

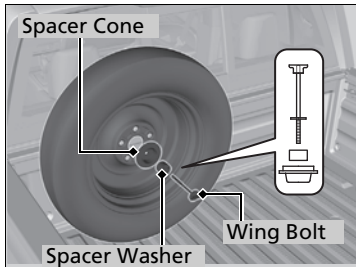

3. Place the compact spare tire on the pickup bed as shown.
4. Place the spacer cone on the wheel hub and the spacer washer within the spacer cone. Then secure the compact spare tire to the pickup bed with the wing bolt as shown.
5. Store or secure the tool box.

If you remove the compact spare tire from the pickup bed, reinstall the cap to its original location.

▶▶ Securing a Compact Spare Tire on the Pickup Bed

The spacer washer is stored in the tool box.

■ TPMS with Tire Fill Assist and the Compact Spare Tire

If you replace a flat tire with the spare tire, the low tire pressure/TPMS indicator comes on while you are driving. After driving for a few miles (kilometers), the indicator will start blinking for a short time and then stay on. **Tire Pressure Monitor Problem** appears on the multi-information display, but this is normal.

If you replace the tire with a specified regular tire, the warning message on the multi-information display and the low tire pressure/TPMS indicator will go off after a few miles (kilometers).

▣ TPMS with Tire Fill Assist and the Compact Spare Tire

The system cannot monitor the pressure of the spare tire. Manually check the spare tire pressure to be sure that it is correct.

Use the TPMS specific wheels. Each is equipped with a tire pressure sensor mounted inside the tire behind the valve stem.

Checking the Engine

If the engine does not start, check the starter.

☞ Checking the Engine

If you must start the vehicle immediately, use an assisting vehicle to jump start it.

☞ **Jump Starting** P. 579

Starter condition

Checklist

Starter doesn't turn or turns over slowly.

The battery may be dead. Check each of the items on the right and respond accordingly.

The starter turns over normally but the engine doesn't start.

There may be a problem with the fuse. Check each of the items on the right and respond accordingly.

Check for a message on the multi-information display.

- If the **To Start, Hold Remote Near Start Button** message appears
 - ☞ **If the Smart Entry Remote Battery is Weak** P. 577
- ▶ Make sure the smart entry remote is in its operating range.
 - ☞ **ENGINE START/STOP Button Operating Range** P. 142

Check the brightness of the interior lights.

Turn on the interior lights and check the brightness.

- If the interior lights are dim or do not come on at all
 - ☞ **Battery** P. 554
- If the interior lights come on normally ☞ **Fuses** P. 589

Review the engine start procedure.

Follow its instructions, and try to start the engine again. ☞ **Starting the Engine** P. 432

Check the immobilizer system indicator.

When the immobilizer system indicator is blinking, the engine cannot be started.

☞ **Immobilizer System** P. 133

Check the fuel level.

There should be enough fuel in the tank. ☞ **Fuel Gauge** P. 103

Check the fuse.

Check all fuses, or have the vehicle checked by a dealer.

☞ **Inspecting and Changing Fuses** P. 593

If the problem continues:

☞ **Emergency Towing** P. 594

If the Smart Entry Remote Battery is Weak

If the beeper sounds, the **To Start, Hold Remote Near Start Button** message appears on the multi-information display, the **ENGINE START/STOP** button flashes, and the engine won't start, start the engine as follows.

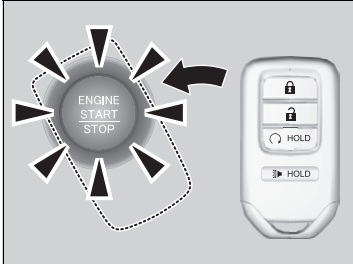

1. Touch the center of the **ENGINE START/STOP** button with the **H** logo on the smart entry remote while the **ENGINE START/STOP** button is flashing. The buttons on the smart entry remote should be facing you.
 - ▶ The **ENGINE START/STOP** button flashes for about 30 seconds.

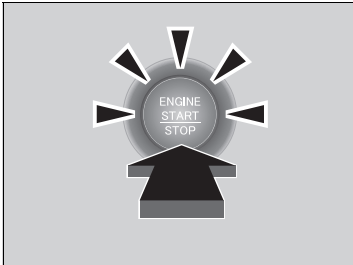

2. Depress the brake pedal and press the **ENGINE START/STOP** button within 10 seconds after the beeper sounds and the **ENGINE START/STOP** button changes from flashing to on.
 - ▶ If you don't depress the pedal, the mode will change to ACCESSORY.

Emergency Engine Stop

The **ENGINE START/STOP** button may be used to stop the engine due to an emergency situation even while driving. If you must stop the engine, do either of the following operations:

- Press and hold the **ENGINE START/STOP** button for about two seconds.
- Firmly press the **ENGINE START/STOP** button three times.

The steering wheel will not lock. However, because turning off the engine disables the power assist the engine provides to the steering and braking systems, it will require significantly more physical effort and time to steer and slow the vehicle. Use both feet on the brake pedal to slow down the vehicle and stop immediately in a safe place.

The power mode is in ACCESSORY when the engine is stopped. To change the mode to VEHICLE OFF, move the shift lever to **P** after the vehicle comes to a complete stop.

Canadian models

Then press the **ENGINE START/STOP** button twice without depressing the brake pedal.

Emergency Engine Stop

Do not press the button while driving unless it is absolutely necessary for the engine to be switched off.

Jump Starting Procedure

Turn off the power to electric devices, such as audio and lights. Turn off the engine, then open the hood.

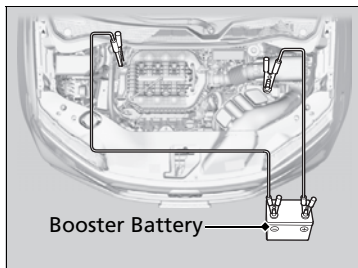
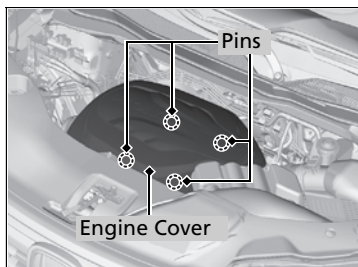

1. Pull up on the engine cover, remove it from the pins.
 - ▶ Start on the passenger side and lift the outermost edge of the cover.
 - ▶ Move towards the driver side while applying uniform upward pressure.
2. Connect the first jumper cable to your vehicle's battery \oplus terminal.
3. Connect the other end of the first jumper cable to the booster battery \oplus terminal.
 - ▶ Use a 12-volt booster battery only.
 - ▶ When using an automotive battery charger to boost your 12-volt battery, select a lower charging voltage than 15 volts. Check the charger manual for the proper setting.
4. Connect the second jumper cable to the booster battery \ominus terminal.

Jump Starting

⚠ WARNING

A battery can explode if you do not follow the correct procedure, seriously injuring anyone nearby.

Keep all sparks, open flames, and smoking materials away from the battery.

Securely attach the jumper cables clips so that they do not come off when the engine vibrates. Also be careful not to tangle the jumper cables or allow the cable ends to touch each other while attaching or detaching the jumper cables.

Battery performance degrades in cold conditions and may prevent the engine from starting.

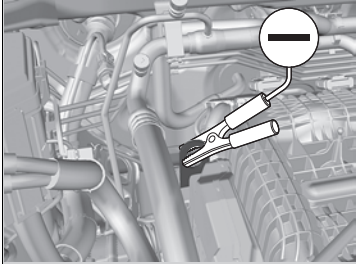

5. Connect the other end of the second jumper cable to the engine hanger as shown. Do not connect this jumper cable to any other part.
6. If your vehicle is connected to another vehicle, start the assisting vehicle's engine and increase its rpm slightly.
7. Attempt to start your vehicle's engine. If it turns over slowly, check that the jumper cables have good metal-to-metal contact.

■ What to Do After the Engine Starts

Once your vehicle's engine has started, remove the jumper cables in the following order.

1. Disconnect the jumper cable from your vehicle's ground.
2. Disconnect the other end of the jumper cable from the booster battery ⊖ terminal.
3. Disconnect the jumper cable from your vehicle's battery ⊕ terminal.
4. Disconnect the other end of the jumper cable from the booster battery ⊕ terminal.

Have your vehicle inspected by a nearby service station or a dealer.

Shift Lever Does Not Move

Follow the procedure below if you cannot move the shift lever out of the **P** position.

Releasing the Lock

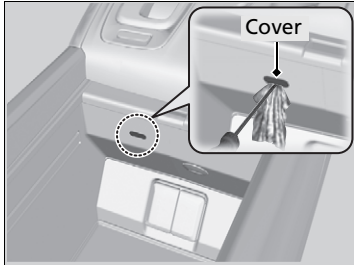

1. Set the parking brake.
2. Remove the built-in key from the smart entry remote.
3. Open the lid of the console compartment.
4. Wrap a cloth around the tip of a small flat-tip screwdriver. Put it into the shift lock release slot as shown in the image, and remove the cover.

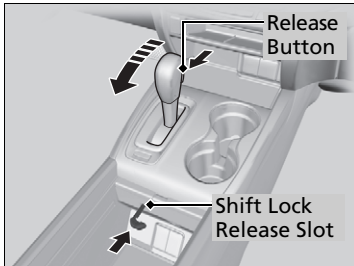

5. Insert the key into the shift lock release slot.
6. While pushing the key down, press the shift lever release button and place the shift lever into **N**.
 - ▶ The lock is now released. Have the shift lever checked by a dealer as soon as possible.

How to Handle Overheating

Overheating symptoms are as follows:

- The temperature gauge needle is at the **H** mark or the engine suddenly loses power.
- Steam or spray comes out of the engine compartment.

■ First thing to do

1. Immediately park the vehicle in a safe place.
2. Turn off all accessories and turn on the hazard warning lights.
 - ▶ **No steam or spray present:** Keep the engine running and open the hood.
 - ▶ **Steam or spray is present:** Turn off the engine and wait until it subsides. Then, open the hood.

☒ How to Handle Overheating

⚠ WARNING

Steam and spray from an overheated engine can seriously scald you.

Do not open the hood if steam is coming out.

NOTICE

Continuing to drive with the temperature gauge needle at the **H** mark may damage the engine.

Continued

■ Next thing to do

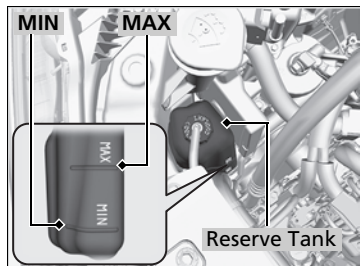

1. Check that the cooling fan is operating and stop the engine once the temperature gauge needle goes down.
 - If the cooling fan is not operating, immediately stop the engine.
2. Once the engine has cooled down, inspect the coolant level and check the cooling system components for leaks.
 - If the coolant level in the reserve tank is low, remove the engine compartment cover then add coolant until it reaches the **MAX** mark.
 - **Engine Compartment Cover** P. 527
 - If there is no coolant in the reserve tank, check that the radiator is cool. Cover the radiator cap with a heavy cloth and open the cap. If necessary, add coolant up to the base of the filler neck, and put the cap back on.

■ Last thing to do

Once the engine has cooled sufficiently, restart it and check the temperature gauge. If the temperature gauge needle has gone down, resume driving. If it has not gone down, contact a dealer for repairs.

►► How to Handle Overheating

⚠ WARNING

Removing the radiator cap while the engine is hot can cause the coolant to spray out, seriously scalding you.

Always let the engine and radiator cool down before removing the radiator cap.

If the coolant is leaking, contact a dealer for repairs.

Use water as an emergency/temporary measure only. Have a dealer flush the system with proper antifreeze as soon as possible.

If the Low Oil Pressure Indicator Comes On



■ Reasons for the indicator to come on

Comes on when the engine oil pressure is low.

■ What to do as soon as the indicator comes on

1. Immediately park the vehicle on level ground in a safe place.
2. If necessary, turn the hazard warning lights on.

■ What to do after parking the vehicle

1. Stop the engine and let it sit for about three minutes.
2. Open the hood and check the oil level.
 - ▶ Add oil as necessary.
 - ▶ **Oil Check** P. 529
3. Start the engine and check the low oil pressure indicator.
 - ▶ The indicator goes off: Start driving again.
 - ▶ The indicator does not go out within 10 seconds: Stop the engine and contact a dealer for repairs immediately.

If the Charging System Indicator Comes On



■ Reasons for the indicator to come on

Comes on when the battery is not being charged.

■ What to do when the indicator comes on

Turn off the climate control system*/heating and cooling system*, rear defogger, and other electrical systems, and immediately contact a dealer for repairs.

☞ If the Low Oil Pressure Indicator Comes On

NOTICE

Running the engine with low oil pressure can cause serious mechanical damage almost immediately.

☞ If the Charging System Indicator Comes On

If you need to stop temporarily, do not turn off the engine. Restarting the engine may rapidly discharge the battery.

* Not available on all models

If the Malfunction Indicator Lamp Comes On or Blinks



■ Reasons for the indicator lamp to come on or blink

- Comes on if there is a problem with the engine emissions control system.
- Blinks when engine misfiring is detected.

■ What to do when the indicator lamp comes on

Avoid high speeds and immediately get your vehicle inspected at a dealer.

■ What to do when the indicator lamp blinks

Park the vehicle in a safe place with no flammable items and wait at least 10 minutes or more with the engine stopped until it cools.

▶▶ If the Malfunction Indicator Lamp Comes On or Blinks

NOTICE

If you drive with the malfunction indicator lamp on, the emissions control system and the engine could be damaged.

If the malfunction indicator lamp blinks again when restarting the engine, drive to the nearest dealer at 31 mph (50 km/h) or less. Have your vehicle inspected.

If the Brake System Indicator (Red) Comes On



■ Reasons for the indicator to come on

- The brake fluid is low.
- There is a malfunction in the brake system.

■ What to do when the indicator comes on while driving

Depress the brake pedal lightly to check pedal pressure.

- If normal, check the brake fluid level the next time you stop.
- If abnormal, take immediate action. If necessary, downshift the transmission to slow the vehicle using engine braking.

If the Electric Power Steering (EPS) System Indicator Comes On



■ Reasons for the indicator to come on

- Comes on when there is a problem with the EPS system.
- If you depress the accelerator pedal repeatedly to increase the engine speed while the engine is idling, the indicator comes on, and sometimes the steering wheel becomes harder to operate.

■ What to do when the indicator comes on

Stop the vehicle in a safe place and restart the engine.

If the indicator comes on and stays on, immediately have your vehicle inspected by a dealer.

▶▶ If the Brake System Indicator (Red) Comes On

Have your vehicle repaired immediately.

It is dangerous to drive with low brake fluid. If there is no resistance from the brake pedal, stop immediately in a safe place. If necessary downshift the gears.

If the brake system indicator and **ABS** indicator come on simultaneously, the electronic brake distribution system is not working. This can result in vehicle instability under sudden braking.

Have your vehicle inspected by a dealer immediately.

If both red and amber brake system indicators come on, stop the vehicle in a safe place and have it inspected by a dealer immediately.

If the Low Tire Pressure/Tire Pressure Monitoring System (TPMS) Indicator Comes On or Blinks



■ Reasons for the indicator to come on or blink

The pressure of one or more tires is significantly low, or TPMS with Tire Fill Assist has not been calibrated. If there is a problem with TPMS with Tire Fill Assist or the compact spare tire is installed, the indicator blinks for about one minute, and then stays on.

■ What to do when the indicator comes on

Drive carefully and avoid abrupt cornering and hard braking. Stop your vehicle in a safe place. Check the tire pressure and adjust the pressure to the specified level. The specified tire pressure is on a label on the driver side doorjamb.

■ What to do when the indicator blinks, then remains on

Have the tire inspected by a dealer as soon as possible. If the compact spare tire causes the indicator to blink, change the tire to a full-size tire. The indicator goes off after driving for a few miles (kilometers).

▶▶ If the Low Tire Pressure/Tire Pressure Monitoring System (TPMS) Indicator Comes On or Blinks

NOTICE

Driving on an extremely underinflated tire can cause it to overheat. An overheated tire can fail. Always inflate your tires to the prescribed level.

TPMS with Tire Fill Assist provides visual and audible assistance during tire pressure adjustment. With the power mode in ON, while you adjust tire pressure up or down, the system alerts you as follows:

Below recommended pressure: The beeper sounds and exterior lights flash once every five seconds.

At recommended pressure: The beeper sounds and exterior lights flash rapidly for five seconds.

Above recommended pressure: The beeper sounds and lights flash twice every three seconds.

Fuse Locations

If any electrical devices are not working, set the power mode to VEHICLE OFF (LOCK) and check to see if any applicable fuse is blown.

Engine Compartment Fuse Box Type A

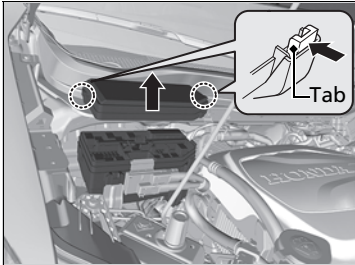

Fuse locations are shown on the fuse box cover. Locate the fuse in question by the fuse number and box cover number. Located near the passenger's side damper house. Push the tabs to open the box.

■ Circuit protected and fuse rating

	Circuit Protected	Amps
1	–	(70 A) ^{*1}
	AC INVERTER	70 A ^{*2}
	RR BLOWER	30 A ^{*1}
	–	(30 A) ^{*2}
	VSA MTR	40 A
	VSA FSR	20 A
	MAIN FAN	30 A ^{*1}
	–	(30 A) ^{*2}
	MAIN FUSE	150 A
	SUB FAN	30 A
	WIP MTR	30 A
	WASHER	20 A
	–	(20 A)
	–	(30 A)
	FR BLOWER	40 A
2	AUDIO AMP	(30 A)
	RR DEF	30 A ^{*1}
	–	(30 A) ^{*2}
	–	(40 A)
	–	(30 A) ^{*1}
	RR DEF	30 A ^{*2}
	–	(20 A)

	Circuit Protected	Amps
3	–	– ^{*1}
	RR BLOWER	30 A ^{*2}
	–	– ^{*1}
	–	(30 A) ^{*2}
	–	– ^{*1}
	–	(30 A) ^{*2}
	–	– ^{*1}
	MAIN FAN	30 A ^{*2}
	SMALL	10 A ^{*1}
	STOP	10 A ^{*2}
4	–	–
5	–	–
6	STOP	10 A ^{*1}
7	SMALL	10 A ^{*2}
8	–	–
9	L H/L LO	10 A ^{*1}
10	IGPS	7.5 A ^{*2}
11	–	–
12	R H/L LO	10 A ^{*1}
13	L H/L LO	10 A ^{*2}
14	IGPS	7.5 A ^{*1}
15	R H/L LO	10 A ^{*2}
16	INJECTOR	20 A ^{*1}
17	IG COIL	15 A ^{*2}
18	H/L LO MAIN	20 A ^{*1}
19	DBW	15 A ^{*2}
20	USB	(15 A)

	Circuit Protected	Amps
15	FR FOG	(15 A) ^{*1}
	BACK UP	10 A ^{*2}
16	HAZARD	15 A ^{*1}
	MAIN RLY	15 A ^{*2}
17	AS P/SEAT (REC)	(20 A)
18	AS P/SEAT (SLI)	(20 A)
19	ACM	20 A
20	MG CLUTCH	7.5 A
21	MAIN RLY	15 A ^{*1}
	HAZARD	15 A ^{*2}
22	FI SUB	15 A
23	IG COIL	15 A ^{*1}
	INJECTOR	20 A ^{*2}
24	DBW	15 A ^{*1}
	H/L LO MAIN	20 A ^{*2}
25	SMALL/STOP MAIN	20 A
26	BACK UP	10 A ^{*1}
	FR FOG	15 A ^{*2}
27	H/STEERING WHEEL	(10 A)
28	HORN	10 A
29	RADIO	20 A

*1: Models without the AC power outlet
 *2: Models with the AC power outlet

Handling the Unexpected

■ Engine Compartment Fuse Box Type B

Fuse locations are shown on the fuse box cover. Locate the fuse in question by the fuse number and box cover number. Located near the brake fluid reservoir. Push the tabs to open the box.

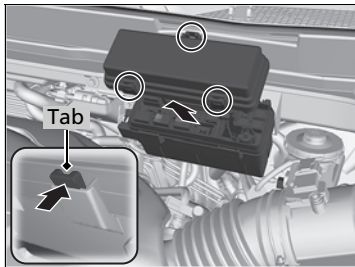

■ Circuit protected and fuse rating

	Circuit Protected	Amps
1	ST CUT1	40 A
	4WD	(20 A)
	IG MAIN	30 A
	IG MAIN2	30 A
	–	–
	F/B MAIN2	60 A
	F/B MAIN	60 A
	EPS	60 A
2	–	–
3	TRL E-BRAKE	(20 A)
4	BMS	7.5 A
5	H/L HI MAIN	20 A
6	+B TRL HAZARD	(7.5 A)
7	+B TRL BACKUP	(7.5 A)
8	CTR ACC SOCKET	20 A
9	TRAILER SMALL	(20 A)
10	ACC/IG2_MAIN	10 A
11	TRL CHARGE	(20 A)
12	–	–
13	–	–
14	–	–
15	FR DE-ICER	(15 A)
16	RR _HTD SEAT	(20 A)
17	STRLD	7.5 A

■ Interior Fuse Box

Located under the dashboard.

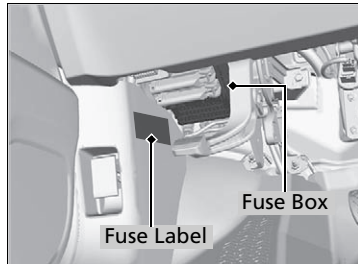

Fuse locations are shown on the label on the side panel.

Locate the fuse in question by the fuse number and label number.

■ Circuit protected and fuse rating

	Circuit Protected	Amps
1	DR P/W	20 A
2	DOOR LOCK	20 A
3	SMART	7.5 A
4	AS P/W	20 A
5	FR ACC SOCKET	20 A
6	FUEL PUMP	20 A
7	ACG	15 A
8	FRONT WIPER	7.5 A
9	ABS/VSA	7.5 A
10	SRS	10 A
11	REAR LEFT P/W	20 A
12	BACK P/W	(20 A)
13	REAR RIGHT P/W	20 A
14	S/R FUEL LID	20 A
15	DR P/SEAT (REC)	(20 A)
16	CARGO LT	7.5 A
17	FR SEAT HEATER	(20 A)
18	INTR LT	7.5 A
19	DR REAR DOOR UNLOCK	10 A
20	AS SIDE DOOR UNLOCK	10 A
21	DRL	7.5 A
22	KEY LOCK	7.5 A
23	A/C	7.5 A
24	IG1a FEED BACK	7.5 A
25	INST PANEL LIGHTS	7.5 A

	Circuit Protected	Amps
26	LUMBAR SUPPORT	(7.5 A)
27	PARKING LIGHTS	7.5 A
28	OPTION	10 A
29	METER	7.5 A
30	–	–
31	MISS SOL	7.5 A
32	SRS	7.5 A
33	AS SIDE DOOR LOCK	10 A
34	DR DOOR LOCK	10 A
35	DR DOOR UNLOCK	10 A
36	DR P/SEAT (SLIDE)	(20 A)
37	RIGHT H/L HI	10 A
38	LEFT H/L HI	10 A
39	IG1b FEED BACK	7.5 A
40	ACC	7.5 A
41	DR REAR DOOR LOCK	10 A
42	–	–

Inspecting and Changing Fuses

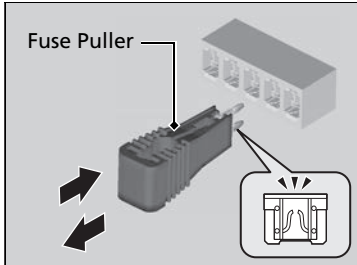
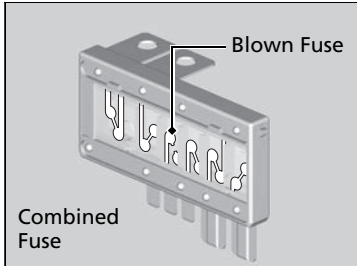

1. Set the power mode to VEHICLE OFF (LOCK). Turn headlights and all accessories off.
2. Remove the fuse box cover.
3. Check the large fuse in the engine compartment.
 - ▶ If the fuse is blown, use a Phillips-head screwdriver to remove the screw and replace it with a new one.
4. Inspect the small fuses in the engine compartment and the vehicle interior.
 - ▶ If there is a burned out fuse, remove it with the fuse puller and replace it with a new one.

Inspecting and Changing Fuses

NOTICE

Replacing a fuse with one that has a higher rating greatly increases the chances of damaging the electrical system.

Replace fuse with a spare fuse of the same specified amperage

Confirm the specified amperage using the charts on P. 589 to P. 592.

There is a fuse puller in the engine compartment fuse box located on the passenger's side.

Emergency Towing

Call a professional towing service if you need to tow your vehicle.

All models

■ Flat bed equipment

The operator loads your vehicle on the back of a truck.

This is the best way to transport your vehicle.

2WD models

■ Wheel lift equipment

The tow truck uses two pivoting arms that go under the front tires and lift them off the ground. The rear tires remain on the ground. **This is an acceptable way to**

tow your vehicle.

»Emergency Towing

NOTICE

Trying to lift or tow your vehicle by the bumpers will cause serious damage. The bumpers are not designed to support the vehicle's weight.

NOTICE

Improper towing such as towing behind a motorhome or other motor vehicle can damage the transmission.

Never tow your vehicle with just a rope or chain. It is very dangerous since ropes or chains may shift from side to side or break.

When You Cannot Unlock the Fuel Fill Door

■ What to Do When Unable to Unlock the Fuel Fill Door

If you cannot unlock the fuel fill door, use the following procedure.

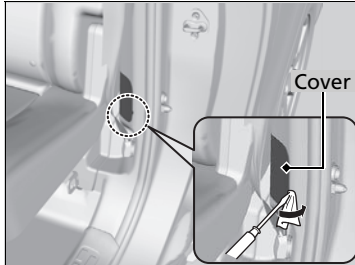

1. Open the rear driver side door.
2. Wrap a cloth around the tip of a small flat-tip screwdriver. Put it into the cover slot as shown in the image, and remove the cover.

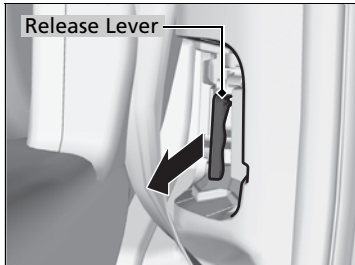

3. Pull the release lever toward you.
 - ▶ The release lever unlocks the fuel fill door when it is pulled.

▣ What to Do When Unable to Unlock the Fuel Fill Door

After taking these steps, contact a dealer to have the vehicle checked.

Refueling From a Portable Fuel Container

If you have run out of fuel and need to refuel your vehicle from a portable fuel container, use the funnel provided with your vehicle.

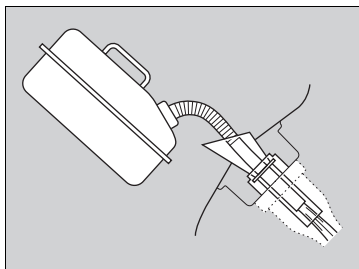
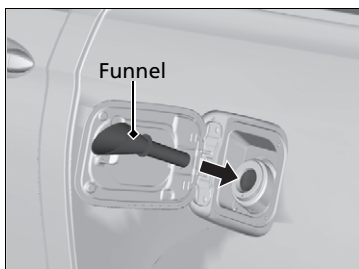
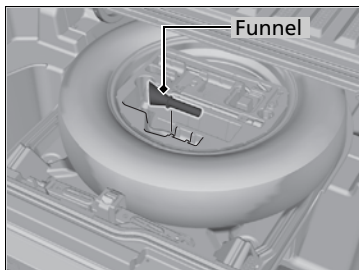

1. Turn off the engine.
2. Press the fuel fill door release button.
 - ▶ The fuel fill door opens.
3. Open the trunk and pull out the tire tray with the handles.
 - ▶ **Getting Ready to Replace the Flat Tire**
P. 568
4. Remove the funnel from the tool box.
5. Place the end of the funnel on the lower part of filler opening, then insert it slowly and fully.
 - ▶ Make sure that the end of the funnel goes down along with the filler pipe.
6. Fill the tank with fuel from the portable fuel container.
 - ▶ Pour fuel carefully so you do not spill any.
7. Remove the funnel from the filler neck.
 - ▶ Wipe up any fuel from the funnel before storing it.
8. Shut the fuel fill door by hand.

▶▶ Refueling From a Portable Fuel Container

⚠ WARNING

Gasoline is highly flammable and explosive. You can be burned or seriously injured when handling fuel.

- Stop the engine, and keep heat, sparks, and flame away.
- Handle fuel only outdoors.
- Wipe up spills immediately.

⚠ WARNING

Do not fill a portable fuel container in the pickup bed. Static electricity can ignite gas vapors and you can be burned.

NOTICE

Do not insert the nozzle of a portable fuel container or any funnel other than the one provided with your vehicle. Doing so can damage the fuel system. Do not try to pry open or push open the filler opening with foreign objects. This can damage the filler opening and its seal.

Make sure the fuel in the portable fuel container is gasoline before you refuel.

☒ Refueling From a Portable Fuel Container

Your vehicle has a warning label for filling a portable fuel container on the left rear side of the pickup bed.

Whenever filling a fuel container, use an approved fuel container, and place it on the ground. Do not fill the fuel container in the vehicle, including the pickup bed and the trunk. Make sure to put the fuel pump nozzle in the fuel filler of the container securely and to handle it properly.

Information

This chapter includes your vehicle's specifications, locations of identification numbers, and other information required by regulation.

Specifications	600
Identification Numbers	
Vehicle Identification Number (VIN), Engine Number, and Transmission Number	602
Devices that Emit Radio Waves	603
Reporting Safety Defects	604
Emissions Testing	
Testing of Readiness Codes	605
Warranty Coverages	607
Authorized Manuals	609
Customer Service Information	610

Vehicle Specifications

Model	Ridgeline
No. of Passengers:	
Front	2
Rear	3
Total	5
Weights:	
Gross Vehicle	6019 lbs (2730 kg) ^{*1}
Weight Rating	5710 lbs (2590 kg) ^{*2}
Gross Axle Weight	3131 lbs (1420 kg) ^{*1}
Rating (Front)	3042 lbs (1380 kg) ^{*2}
Gross Axle Weight	3219 lbs (1460 kg) ^{*1}
Rating (Rear)	3042 lbs (1380 kg) ^{*2}
Gross Combined Weight	9987 lbs (4530 kg) ^{*1}
Rating	8201 lbs (3720 kg) ^{*2}

*1: Models with AWD

*2: Models with 2WD

Air Conditioning

Air Conditioning:	
Refrigerant Type	HFO-1234yf (R-1234yf)
Charge Quantity	20.3 – 22.0 oz (575 – 625 g)
Lubricant Type	RL85HM (POE)
Quantity	7.5 – 8.7 cu-in (123 – 143 cm ³)

Engine Specifications

Displacement	211.8 cu-in (3,471 cm ³)	
Spark Plugs	NGK	DILZKR7B11G

Fuel

Type	Unleaded gasoline, Pump octane number of 87 or higher	
Fuel Tank Capacity	19.5 US gal (73.8 ℓ)	

Washer Fluid

Tank Capacity	U.S.: 1.0 US gal (3.8 ℓ) Canada: 1.4 US gal (5.3 ℓ)	
---------------	--	--

Light Bulbs

Headlights (Low Beam)	LED ^{*1} 55 W ^{*2} (H11)
Headlights (High Beam)	60W (HB3)
Fog Lights*	35 W (H8)
Front Turn Signal/Parking Lights*	28/8 W (Amber)
Parking Lights*	LED
Front Side Marker Lights	LED
Daytime Running Lights	LED ^{*3} 60W (HB3) ^{*4}
Side Turn Signal Lights (on Door Mirrors)*	LED
Rear Side Marker Lights	LED
Brake/Taillights	LED
Back-Up Lights	21 W
Rear Turn Signal Lights	21 W
High-Mount Brake Light	LED
Rear License Plate Lights	5 W
Bed Lights	LED ^{*1} 3CP ^{*2}
Interior Lights	
Front Map Lights	LED ^{*5} 5 W ^{*6}
Rear Map Lights	5 W
Vanity Mirror Lights*	1.4 W
Door Pocket Lights*	LED
Beverage Holder Light*	LED
Door Courtesy Lights*	3.8 W
Door Inner Handle Lights*	LED
Console Compartment Light	1.4 W
Glove Box Light	1.4 W
Foot Lights*	LED

*1: Models with LED low beam headlights

*2: Models without LED low beam headlights

*3: Models with LED day time running lights

*4: Models without LED day time running lights

*5: Models with moonroof

*6: Models without moonroof

■ Brake Fluid

Specified	Honda Heavy Duty Brake Fluid DOT 3
-----------	------------------------------------

■ Automatic Transmission Fluid

Specified	Honda ATF DW-1 (automatic transmission fluid)	
Capacity	Change	3.3 US qt (3.1 ℓ)

■ Rear Differential Fluid*

Specified	Honda All Wheel Drive Fluid (DPSF-II)	
Capacity	Change	1.92 US qt (1.82 ℓ)

■ Transfer Assembly Fluid*

Specified	<ul style="list-style-type: none"> ·Honda Hypoid Gear Oil HGO-1 ·Hypoid gear oil SAE 75W-85 or SAE 90 (API grade GL4 or GL5) 	
Capacity	Change	0.45 US qt (0.43 ℓ)

■ Engine Oil

Recommended	<ul style="list-style-type: none"> ·Genuine Honda Motor Oil 0W-20 ·API Premium-grade 0W-20 detergent oil 	
Change	5.4 US qt (5.1 ℓ)	
Capacity	Change including filter	5.7 US qt (5.4 ℓ)

■ Engine Coolant

Specified	Honda Long Life Antifreeze/Coolant Type 2	
Ratio	50/50 with distilled water	
	1.88 US gal (7.13 ℓ)	
Capacity	(change including the remaining 0.19 US gal (0.72 ℓ) in the reserve tank)	

■ Tire

Regular	Size	245/60R18 105H
	Pressure psi (kPa [kgf/cm ²])	35 (240 [2.4])
Compact Spare	Size	T165/90R17 105M
	Pressure psi (kPa [kgf/cm ²])	60 (420 [4.2])
Wheel Size	Regular	18 x 8J
	Compact Spare	17 x 4T

* Not available on all models

Vehicle Identification Number (VIN), Engine Number, and Transmission Number

Your vehicle has a 17-digit vehicle identification number (VIN) used to register your vehicle for warranty purposes, and for licensing and insuring your vehicle.

The locations of your vehicle's VIN, engine number, and transmission number are shown as follows.

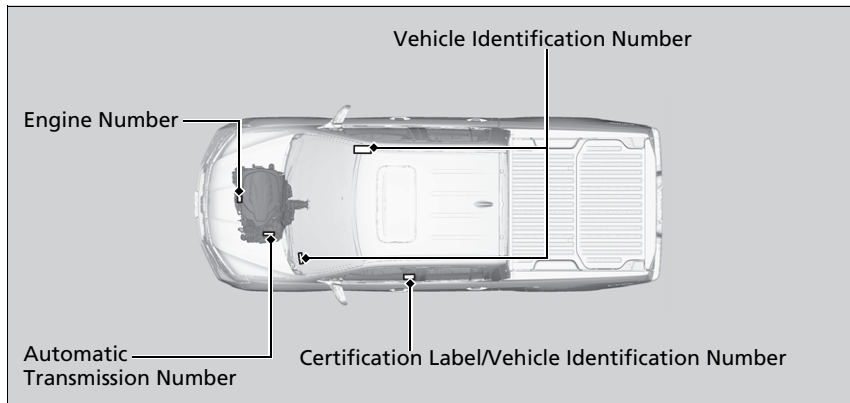

» Vehicle Identification Number (VIN), Engine Number, and Transmission Number

The interior vehicle identification number (VIN) is located under the cover.



Devices that Emit Radio Waves

The following products and systems on your vehicle emit radio waves when in operation.

HondaLink*

Audio System

Blind spot information System*

Bluetooth® Audio

Bluetooth® HandsFreeLink®

HomeLink® Universal Transceiver*

Collision Mitigation Braking System™*

Immobilizer System

Remote Transmitter

Smart Entry System*

Tire Pressure Monitoring System (TPMS)

Remote Engine Start System*

Each of the above complies with the appropriate requirements or the required standards of FCC (Federal Communications Commission) and Industry Canada Standard, described below:

As required by the FCC:

This device complies with Part 15 of the FCC rules. Operation is subject to the following two conditions: (1) This device may not cause harmful interference, and (2) this device must accept any interference received, including interference that may cause undesired operation.

Changes or modifications not expressly approved by the party responsible for compliance could void the user's authority to operate the equipment.

This device complies with industry Canada licence-exempt RSS standard(s). Operation is subject to the following two conditions: (1) this device may not cause interference, and (2) this device must accept any interference, including interference that may cause undesired operation of the device.

* Not available on all models

In the U.S.

If you believe that your vehicle has a defect which could cause a crash or could cause injury or death, you should immediately inform the National Highway Traffic Safety Administration (NHTSA) in addition to notifying American Honda Motor Co., Inc.

If NHTSA receives similar complaints, it may open an investigation, and if it finds that a safety defect exists in a group of vehicles, it may order a recall and remedy campaign. However, NHTSA cannot become involved in individual problems between you, your dealer, or American Honda Motor Co., Inc.

To contact NHTSA, you may call the Vehicle Safety Hotline toll-free at 1-888-327-4236 (TTY: 1-800-424-9153); go to <http://www.safercar.gov>; or write to: Administrator, NHTSA, 1200 New Jersey Avenue, SE., Washington, DC 20590. You can also obtain other information about motor vehicle safety from <http://www.safercar.gov>.

In Canada

If you believe that your vehicle has a defect which could cause a crash or could cause injury or death, you should immediately inform Honda Canada Inc. and you may also inform Transport Canada.

If Transport Canada receives similar complaints, it may open an investigation, and if it finds that a safety defect exists in a group of vehicles, it may lead to a recall and remedy campaign. However, Transport Canada cannot become involved in individual problems between you, your dealer, or Honda Canada Inc.

To contact Transport Canada's Defect Investigations and Recalls Division, you may call 1-800-333-0510. For more information on reporting safety defects or about motor vehicle safety, go to <http://www.tc.gc.ca/roadsafety>.

Testing of Readiness Codes

Your vehicle has readiness codes as part of the onboard self diagnostic system. Some States use these codes for testing to verify whether your vehicle's emissions components are working properly. The codes may not be read properly if testing is performed just after the battery has gone dead or been disconnected.

To check if they are set, set the power mode to ON, without starting the engine. The malfunction indicator lamp will come on for several seconds. If it then goes off, the readiness codes are set. If it blinks five times, the readiness codes are not set.

If you are required to have your vehicle tested before the readiness codes are ready, prepare the vehicle for retesting by doing the following:

1. Fill the gas tank to approximately 3/4 full.
2. Park the vehicle and leave the engine off for 6 hours or more.
3. Make sure the ambient temperature is between 40°F and 95°F (4°C and 35°C).
4. Start the engine without touching the accelerator pedal, and let it idle for 20 seconds.
5. Keep the vehicle in **P**. Increase the engine speed to 2,000 rpm, and hold it there for about 3 minutes.
6. Let the engine idle with your foot off the accelerator for 20 seconds.

Testing of Readiness Codes

The readiness codes are erased when the battery is disconnected, and set again only after several days of driving under a variety of conditions.

If a testing facility determines that the readiness codes are not set, you may be requested to return at a later date to complete the test.

If the testing facility determines the readiness codes are still not set, see a dealer.

7. Select a nearby, lightly traveled major highway where you can maintain a speed of 50 to 60 mph (80 to 97 km/h) for at least 20 minutes. Drive on the highway in **D**. Do not use cruise control. When traffic allows, drive for 90 seconds without moving the accelerator pedal. (Vehicle speed may vary slightly; this is okay.) If you cannot do this for a continuous 90 seconds because of traffic conditions, drive for at least 30 seconds, then repeat it two more times (for a total of 90 seconds).
8. Drive in city or suburban traffic for at least 10 minutes. When traffic conditions allow, let the vehicle coast for several seconds without using the accelerator pedal or the brake pedal.
9. Park the vehicle and leave the engine off for 30 minutes.

■ U.S. Owners

Your new vehicle is covered by these warranties:

New Vehicle Limited Warranty – covers your new vehicle, except for the emissions control systems and accessories, against defects in materials and workmanship.

Emissions Control Systems Defects Warranty and Emissions Performance Warranty – these two warranties cover your vehicle's emissions control systems. Time, mileage, and coverage are conditional. Please read your warranty booklet for exact information.

Seat Belt Limited Warranty – a seat belt that fails to function properly is covered by a limited warranty. Please read your warranty booklet for details.

Rust Perforation Limited Warranty – all exterior body panels are covered for rust-through from the inside for the specified time period with no mileage limit.

Accessory Limited Warranty – Honda accessories are covered under this warranty. Time and mileage limits depend on the type of accessory and other factors. Please read your warranty booklet for details.

Replacement Parts Limited Warranty – covers all Honda replacement parts against defects in materials and workmanship.

Replacement Battery Limited Warranty – provides prorated coverage for a replacement battery purchased from a dealer.

Replacement Muffler Lifetime Limited Warranty – provides coverage for as long as the purchaser of the muffler owns the vehicle.

Restrictions and exclusions apply to all these warranties. Please read the Honda warranty information booklet that came with your vehicle for precise information on warranty coverages. Your vehicle's original tires are covered by their manufacturer. Tire warranty information is in a separate booklet.

■ **Canadian Owners**

Please refer to the warranty manual that came with your vehicle.

■ **EPA Contact Information**

An owner may obtain further information concerning emission warranties or report violations of the terms of the emission warranties by contacting:

U.S. Environmental Protection Agency
Office of Transportation and Air Quality
Compliance Division, Light-Duty Vehicle Group
Attn: Warranty Complaints
2000 Traverwood Drive
Ann Arbor, MI 48105
Email: complianceinfo@epa.gov

■ Service Express

For electronic copies of service publications, you can purchase a subscription to Service Express. Visit www.techinfo.honda.com for pricing and options.

■ For U.S. Owners

Manuals can be purchased from Helm Incorporated. You can order a manual by phone at 1-(800) 782-4356 (credit card orders only), or online at www.helminc.com.

■ For Canadian Owners

Please contact a dealer to order any manuals that you may require.

Honda dealership personnel are trained professionals who should be able to deal with any problems you may encounter with your vehicle. If, however, you are faced with a problem that they cannot resolve to your satisfaction, contact Honda Customer Services.

U.S. Owners

American Honda Motor Co., Inc.
Honda Automobile Customer Services
Mail Stop 100-5E-8A
1919 Torrance Blvd.
Torrance, CA 90501-2746
Tel: 1 (800) 999-1009

Canadian Owners

Honda Canada Inc.
Customer Relations
180 Honda Boulevard
Markham, ON
L6C 0H9
Tel: 1-888-9-HONDA-9
Fax: 1-877-939-0909
E-mail: Honda_cr@ch.honda.com

In Puerto Rico and the U.S. Virgin Islands

Bella International
P.O. Box 190816
San Juan, PR 00919-0816
Tel: 1 (787) 620-7546

Customer Service Information

When you call or write, please give us the following information:

- Vehicle Identification Number
 - ▣ **Vehicle Identification Number (VIN), Engine Number, and Transmission Number** P. 602
- Date of purchase
- Odometer reading of your vehicle
- Your name, address, and telephone number
- A detailed description of the problem
- Name of the dealer who sold the vehicle to you

A

- ABS (Anti-lock Brake System) 490
- AC Power Outlet 184
- Accessories and Modifications 563
- Accessory Power Sockets 177
- Adaptive Cruise Control (ACC) 455
 - Indicator 85
- Additives
 - Coolant 533
 - Engine Oil 528
 - Washer 536
- Adjusting
 - Armrest 170
 - Front Seats 163
 - Head Restraints 168, 169
 - Mirrors 161
 - Rear Seats 166
 - Steering Wheel 160
 - Temperature 106
- Agile Handling Assist 478
- Air Conditioning System
(Climate Control System) 188
 - Changing the Mode 189
 - Defrosting the Windshield and
Windows 189
 - Dust and Pollen Filter 556
 - Recirculation/Fresh Air Mode 189
 - Sensor 194
 - Synchronized Mode 191
 - Using Automatic Climate Control 188
- Air Conditioning System
(Heating and Cooling System) 195
 - Cooling 197
 - Defrosting the Windshield and
Windows 198
 - Heating 196
- Air Pressure 546, 601
- Airbags 42
 - Advanced Airbags 48
 - After a Collision 46
 - Airbag Care 54
 - Front Airbags (SRS) 45
 - Indicator 52, 77
 - Passenger Airbag Off Indicator 53
 - Sensors 42
 - Side Airbags 49
 - Side Curtain Airbags 51
- All-wheel drive (AWD) Indicator 83
- AM/FM Radio 213, 249
- Android Auto 289
- Anti-lock Brake System (ABS) 490
 - Indicator 77
- Apple CarPlay 286
- Armrest 170
- Audio Remote Controls 204
- Audio System 200
 - Adjusting the Sound 211, 242
 - Audio/Information Screen 207, 225
 - Auxiliary Input Jack 202
 - Changing the Home Screen Icon
Layout 229
- Closing Apps 239
- Display Setup 212, 243
- Error Messages 294
- General Information 298
- Home Screen 232
- Limitations for Manual Operation 244
- MP3/WMA/AAC 218, 261, 273
- Playing a CD 261
- Reactivating 203
- Recommended CDs 299
- Remote Controls 204
- Security Code 203
- Selecting an Audio Source 244
- Status Area 238
- Theft Protection 203
- USB Flash Drives 301
- USB Port 201
- Wallpaper Setup 209, 230
- Audio/Information Screen 207, 225
- Authorized Manuals 609
- Auto Door Locking/Unlocking 124
 - Customize 340
- Auto High-Beam 151
- Auto high-beam Indicator 81
- Automatic Intermittent Wipers 155
- Automatic Lighting 147

Automatic Transmission	439
Creeping	439
Fluid	535
Kickdown	439
Shift Lever Does Not Move.....	582
Shift Lever Operation	441
Shifting.....	440
Auxiliary Input Jack	202
Average Fuel Economy.....	106

B

Battery	554
Charging System Indicator.....	75, 585
Jump Starting	579
Maintenance (Checking the Battery)	554
Maintenance (Replacing).....	555
Bed Lights.....	186
Indicator.....	90
Belts (Seat)	35
Beverage Holders.....	175
Blind spot information (BSI) System	484
Indicator.....	87
Bluetooth® Audio	221, 276
Bluetooth® HandsFreeLink®	351, 376
Booster Seats (For Children).....	69
Brake System.....	488
Anti-lock Brake System (ABS).....	490
Brake Assist System	491
Brake System Indicator.....	74
Fluid	536

Foot Brake.....	489
Indicator.....	74, 587
Parking Brake.....	488
Brake System Indicator (Amber).....	74
Brake System Indicator (Red).....	74
Brightness Control (Instrument Panel)....	157
Bulb Replacement	537
Brake/Taillight and Rear Side Marker	
Light.....	541
Daytime Running Light and Parking	
Light.....	539
Front Side Marker Light.....	539
Front Turn Signal/Parking and Fog	
Light.....	540
Headlights.....	537
High-Mount Brake Light.....	542
Rear License Plate Light	542
Rear Turn Signal and Back-Up Light.....	541
Side Turn Signal/Emergency Indicator	
Light.....	540
Bulb Specifications	600

C

Carbon Monoxide Gas	70
Cargo Hooks	187
Carrying Cargo	411, 413, 416
CD Player.....	261
Certification Label.....	602
Changing Bulbs	537
Charging System Indicator.....	75, 585

Child Safety	55
Childproof Door Locks	123
Emergency Trunk Opener.....	132
Child Seat	55
Booster Seats	69
Child Seat for Infants	57
Child Seat for Small Children	58
Installing a Child Seat with a Lap/Shoulder Seat	
Belt	63
Installing a LATCH-Compatible Child	
Seat	60
Larger Children	68
Rear-facing Child Seat.....	57
Selecting a Child Seat	59
Using a Tether	65
Childproof Door Locks	123
Cleaning the Exterior	559
Cleaning the Interior	557
Climate Control System	188
Changing the Mode.....	188
Defrosting the Windshield and	
Windows	189
Dust and Pollen Filter	556
Recirculation and Fresh Air Mode.....	189
Sensors	194
Synchronized Mode	191
Using Automatic Climate Control.....	188
Clock	110
Coat Hook	178

Collision Mitigation Braking System™ (CMBS™)	492
Indicator	88, 89
Compact Spare Tire	567, 601
Console Compartment	174
Controls	109
Conversation Mirror	179
Coolant (Engine)	533
Adding to the Radiator	534
Adding to the Reserve Tank	533
Overheating	583
Creeping (Automatic Transmission)	439
Cross Traffic Monitor	506
Cruise Control	445
Indicator	82
Cup Holders	175
Customer Service Information	610
Customized Features	317
D	
Daytime Running Lights	150
Dead Battery	579
Defaulting All the Settings	347
Defogger/Heated Door Mirror	156
Defrosting the Windshield and Windows	189, 198
Devices that Emit Radio Waves	603
Dimming	
Headlights	146
Rearview Mirror	161

Dipstick (Engine Oil)	529
Directional Signals (Turn Signal)	145
Display Button	225
Door Mirrors	162
Doors	111
Auto Door Locking	124
Auto Door Unlocking	124
Door Open Message	34, 91
Keys	111
Locking/Unlocking the Doors from the Inside	14, 121
Locking/Unlocking the Doors from the Outside	114
Lockout Prevention System	120
DOT Tire Quality Grading	548
Driving	409
Adaptive Cruise Control (ACC)	455
Automatic Transmission	439
Braking	488
Cruise Control	445
Off-Highway Driving Guidelines	430
Starting the Engine	432
Driving Guidelines for Your Utility Vehicle	438
Driving Position Memory System	158
Dust and Pollen Filter	556
E	
ECON Button	442
ECON Mode Indicator	87

Electric Power Steering (EPS) System Indicator	80, 587
Electronic Stability Control (ESC)	476
Emergency	594
Emergency Trunk Opener	132
Emissions Testing (Readiness Codes)	605
Engine	602
Coolant	533
Jump Starting	579
Oil	528
Remote Engine Start	434
Starting	432
Engine Compartment Cover	527
Engine Coolant	533
Adding to the Radiator	534
Adding to the Reserve Tank	533
Overheating	583
Temperature Gauge	103
Engine Oil	528
Adding	530
Checking	529
Displaying Oil Life	521
Low Oil Pressure Indicator	75, 585
Recommended Engine Oil	528
ENGINE START/STOP Button	142
EPS (Electric Power Steering) System	80, 587
Exhaust Gas Hazard (Carbon Monoxide)	70
Exterior Care (Cleaning)	559
Exterior Mirrors	162

F

Features	199
Filters	
Dust and Pollen	556
Oil	531
Flat Tire	567
Floor Mats	558
Fluids	
Automatic Transmission	535
Brake	536
Engine Coolant	533
Windshield Washer	536
FM/AM Radio	213, 249
Fog Lights	149
Indicator.....	81
Folding Up the Rear Seat	166
Foot Brake	489
Front Airbags (SRS)	45
Front Seats	163
Adjusting.....	163
Front Sensor Camera	448
Fuel	21, 512
Economy	515
Gauge	103
Instant Fuel Economy.....	107
Low Fuel Indicator	77
Range.....	107
Recommendation	512
Refueling	512
Fuel Economy and CO₂ Emissions	515
Fuel Fill Door	21, 513
Unable to Unlock	595
Fuses	589
Inspecting and Changing.....	593
Locations.....	589, 591, 592
G	
Gasoline (Fuel)	
Economy	515
Gauge.....	103
Information	512
Instant Fuel Economy	107
Low Fuel Indicator	77
Refueling.....	512
Gauges	103
Glass (care)	561
Glove Box	173
H	
Halogen Bulbs	537
Handling the Unexpected	565
HandsFreeLink® (HFL)	351, 376
Automatic Import of Cellular Phonebook and Call History.....	365, 389
Caller's ID Information.....	363
Displaying Messages.....	403
HFL Buttons	351, 376
HFL Menus.....	353, 379
HFL Status Display	352, 378
In Case of Emergency	407
Limitations for Manual Operation....	352, 378
Making a Call	370, 397
Options During a Call.....	375, 400
Phone Setup	357, 384
Phonebook Phonetic Modification.....	393
Receiving a Call.....	374, 400
Receiving a Text Message/E-mail	401
Ring Tone	363, 388
Selecting a Mail Account.....	402
Speed Dial	366, 390
To Clear the System	364
To Set Up a Text Message/E-mail Options.....	387
Hazard Warning Button	4
Hazard Warning Indicator	80
HD Radio™	249
Head Restraints	168, 169
Headlights	146
Aiming.....	537
Auto High-Beam	151
Automatic Operation	147
Dimming.....	146, 150
Operating	146
Heated Door Mirrors	156
Heated Steering Wheel	180
Heated Windshield Button	156
Heater (Steering Wheel)	180
Heaters (Seat)	181, 182, 183

Heating and Cooling System	195	Charging System	75, 585	Information	599
Cooling.....	197	Collision Mitigation Braking System™ (CMBS™).....	88, 89	Information Button.....	104
Defrosting the Windshield and Windows	198	CRUISE CONTROL.....	82, 446	Instant Fuel Economy.....	107
Heating.....	196	CRUISE MAIN	82, 445	Instrument Panel.....	73
HFL (HandsFreeLink®)	351, 376	ECON Mode	87	Brightness Control.....	157
High Beam Indicator	80	Electric Power Steering (EPS) System.....	80, 587	Intelligent Traction Management System	443
Hill Start Assist System.....	437	Fog Lights.....	81	Intelligent VT M4 (i-VTM4).....	479
HomeLink® Universal Transceiver	348	High Beam	80	Interior Lights.....	171
Honda App License Agreement	302	Immobilizer System.....	81	Interior Rearview Mirror.....	161
Honda Sensing™.....	22	Lane Keeping Assist System (LKAS)....	86, 470	iPhone.....	301
HondaLink®	278	Lights On.....	81	iPod	215, 264, 301
I		Low Fuel.....	77	J	
Identification Numbers.....	602	Low Oil Pressure	75, 585	Jack (Wheel Nut Wrench)	571
Engine and Transmission.....	602	Low Tire Pressure/TPMS	80, 588	Jump Starting	579
Vehicle Identification.....	602	Malfunction Indicator Lamp.....	75, 586	K	
Illumination Control	157	Parking Brake and Brake System (Red).....	74, 587	Key Number Tag.....	112
Button	157	Road Departure Mitigation (RDM).....	84	Keyless Lockout Prevention	120
Immobilizer System.....	133	Seat Belt Reminder	36, 76	Keys.....	111
Indicator	81	Security System Alarm	82	Lockout Prevention.....	120
In-Bed Box	184	Shift Lever Position	76	Number Tag	112
Indicators.....	74	Smart Entry System.....	83	Rear Door Won't Open.....	123
Adaptive Cruise Control (ACC).....	85	Supplemental Restraint System	52, 77	Remote Transmitter	119
All-wheel drive (AWD).....	83	System Message	82	Types and Functions.....	111
Anti-lock Brake System (ABS)	77	Transmission.....	76	Kickdown (Automatic Transmission).....	439
Auto high-beam	81	Turn Signal and Hazard Warning	80		
Bed Lights On	90	Vehicle Stability Assist (VSA®) OFF.....	477		
Blind spot information (BSI).....	87, 485	Vehicle Stability Assist (VSA®) System.....	78, 476		
Brake System (Amber).....	74				

L

Lane Keeping Assist System (LKAS)	468
Indicator	86
LaneWatch™	486
Language (HFL)	352, 378
LATCH (Child Seats)	60, 65
Lights	146, 537
Automatic	147
Bed	186
Bulb Replacement	537
Daytime Running Lights	150
High Beam Indicator	80
Interior	171
Light Switches	146
Lights On Indicator	81
Turn Signals	145
Load Limits	413
Locking/Unlocking	111
Auto Door Locking/Unlocking	124
Childproof Door Locks	123
From Inside	121
From Outside	114
Keys	111
Using a Key	120
Lockout Prevention System	120
Low Battery Charge	585
Low Fuel Indicator	77
Low Oil Pressure Indicator	75, 585
Low Tire Pressure Indicator	80
Lower Anchors	60, 65
Lubricant Specifications Chart	601

Luggage (Maximum Load Limit)	413
Lumbar Support	163

M

Maintenance	517
Battery	554
Brake Fluid	536
Cleaning	557
Climate Control System	556
Coolant	533
Heating and Cooling System	556
Maintenance Minder™	521
Oil	529
Precautions	518
Radiator	534
Remote Transmitter	555
Replacing Light Bulbs	537
Safety	519
Service Items	523
Tires	545
Transmission Fluid	535
Under the Hood	525
Malfunction Indicator Lamp	75, 586
Map Lights	172
Maximum Load Limit	413
Meters, Gauges	103
Mirrors	161
Adjusting	161
Door	162
Exterior	162

Interior Rearview	161
Modifications (and Accessories)	563
Moonroof	140
MP3	218, 261, 273
MP3/WMA/AAC	218, 261, 273
Multi-Information Display	104
Multi-View Rear Camera	510

N

Numbers (Identification)	602
--------------------------------	-----

O

Odometer	105
Off-Highway Driving Guidelines	430
Oil (Engine)	528
Adding	530
Checking	529
Displaying Oil Life	521
Low Oil Pressure Indicator	75, 585
Recommended Engine Oil	528
Viscosity	528
Open Source Licenses	316
Opening/Closing	
Hood	526
Moonroof	140
Power Windows	136
Tailgate	128
Trunk	130
Outside Temperature Display	106

Overheating 583

P

Pandora® 271

Panic Mode 135

Parking 501

Parking Brake 488

Parking Brake and Brake System

Indicator 74, 587

Parking Sensor System 502

Passenger Airbag Off Indicator 53

Passing Indicators 146

Playing *Bluetooth*® Audio 221, 276

Power Windows 136

Precautions While Driving 438

Driving Guidelines for Your Utility

Vehicle 438

Rain 438

Pregnant Women 40

Puncture (Tire) 567

R

Radiator 534

Radio (FM/AM) 213, 249

Radio (SiriusXM®) 253

Radio Data System (RDS) 214, 251

Range 107

RDS (Radio Data System) 214, 251

Readiness Codes (Emissions Testing) 605

Rear Climate Control System

From the Rear Panel 193

Rear Defogger/Heated Door Mirror

Button 156

Rear Outer Seat Heaters 183

Rear Seats 166

Rearview Mirror 161

Refueling 512

Fuel Gauge 103

Gasoline 512, 600

Low Fuel Indicator 77

Regulations 482, 548, 603

Remote Engine Start 434

Remote Transmitter 119

Replacement

Battery 555

Bulbs 537

Fuses 589, 591, 592

Tires 551

Wiper Blade Rubber 543

Reporting Safety Defects 604

RESET Button 104

Resetting a Trip Meter 106

Reverse Tilt Door Mirror 162

Road Departure Mitigation (RDM) 450

Indicator 84

On and Off 452

S

Safe Driving 29

Safety Check 34

Safety Labels 71

Safety Message 1

Seat Belts 35

Adjusting the Shoulder Anchor 39

Automatic Seat Belt Tensioners 37

Checking 41

Fastening 38

Installing a Child Seat with a Lap/Shoulder Seat

Belt 63

Pregnant Women 40

Reminder 36

Warning Indicator 36, 76

Seat Heaters 181, 182, 183

Seat Ventilation 182

Seats 163

Adjusting 163

Driver's Seat Lumbar Support 163

Front Seats 163

Rear Seats 166

Seat Heaters 181, 182, 183

Seat Ventilation 182

Security System 133

Immobilizer System Indicator 81

Security System Alarm Indicator 82

Selecting a Child Seat 59

Selector Knob (Audio) 206

Setting the Clock 110

Shift Lever	20, 440, 441	Sunglasses Holder.....	179	Wear Indicators.....	550
Does Not Move.....	582	Supplemental Restraint System (SRS).....	45	Winter	553
Operation	20, 440, 441	Indicator.....	77	Tools	566
Releasing	582	Switches		Towing a Trailer	418
Shift Lever Position Indicator.....	76	(Around the Steering Wheel)	4, 5, 142	Equipment and Accessories	422
Shifting (Transmission)	20, 440	SYNC Mode.....	191	Load Limits	418
Shoulder Anchor.....	39	System Message Indicator.....	82	Towing Your Vehicle	429
Side Airbags.....	49			Emergency.....	594
Side Curtain Airbags.....	51	T		TPMS with Tire Fill Assist	480
Siri Eyes Free	285	Tachometer	103	Indicator	80, 588
SiriusXM® Radio	253	Tailgate	128	Tire Fill Assist	588
Smart Entry System Indicator.....	83	Temperature		Trailer Stability Assist	427
Smart Entry with Push Button Start		Gauge.....	103	Transmission	20, 439, 440
System.....	114	Outside Temperature Display.....	106	Automatic.....	439, 440
Snow Tires.....	553	Temperature Gauge	103	Fluid	535
Song By Voice™ (SBV)	267	Temperature Sensor	106, 194	Number	602
Spare Tire	567, 601	Tie-down Anchors	186	Shift Lever Position Indicator	76
Spark Plugs.....	600	Time (Setting)	110	Transmission Indicator.....	76
Specifications	600	Tire Fill Assist	480, 588	Trip Meter	106
Specified Fuel.....	512, 600	Tires	545	Troubleshooting	565
Speedometer.....	103	Air Pressure	546, 601	Blown Fuse	589, 591, 592
SRS Airbags (Airbags)	45	Checking and Maintaining	545	Brake Pedal Vibrates	25
Starting the Engine	432	Inspection	545	Buzzer Sounds When Opening Door	26
Does Not Start.....	576	Labeling	546	Emergency Towing	594
Jump Starting.....	579	Puncture (Flat Tire)	567	Engine Won't Start	576
Remote Engine Start.....	434	Regulations	548	Noise When Braking	26
Steering Wheel	160	Rotation.....	552	Overheating.....	583
Adjusting.....	160	Spare Tire.....	567, 601	Puncture/Flat Tire	567
Heater	180	Summer	553	Rear Door Won't Open	26, 123
Stopping	501	Tire Chains.....	553	Shift Lever Does Not Move.....	582
Summer Tires	553			Warning Indicators.....	74

Trunk	130
Lid	130
Main Switch.....	131
Turn Signals.....	145
Indicators (Instrument Panel).....	80
Turn-by-Turn Directions	107

U

Unlocking the Doors.....	114
Unlocking the Front Doors	
from the Inside.....	14, 121
USB Flash Drives.....	218, 273, 301
USB Port.....	201

V

Vanity Mirrors	7
Vehicle Identification Number.....	602
Vehicle Stability Assist (VSA®)	476
Off Button	477
System Indicator	78, 476
Ventilation	195
Viscosity (Oil).....	528, 601
Voice Control Operation	245
Audio Commands.....	247
Climate Control Commands.....	248
General Commands.....	248
Music Search Commands.....	248
On Screen Commands	248
Phone Commands	247

Useful Commands.....	247
Voice Portal Screen.....	246
Voice Recognition.....	245
VSA® (Vehicle Stability Assist).....	476

W

Wallpaper	209, 230
Warning and Information Messages.....	91
Warning Indicator On/Blinking	585
Warning Labels.....	71
Warranties (Warranty Manual provided	
separately).....	607
Watts	600
Wear Indicators (Tire).....	550
Wheel Nut Wrench (Jack Handle)	571
Wi-Fi Connection	283
Window Washers.....	154
Adding/Refilling Fluid.....	536
Switch	154
Windows (Opening and Closing).....	136
Windshield	154
Cleaning.....	561
Defrosting	198
Defrosting/Defogging	189
Washer Fluid	536
Wiper Blades	543
Wipers and Washers	154
Winter Tires	553
Snow Tires.....	553
Tire Chains	553

Wipers and Washers.....	154
Automatic Intermittent Wipers	155
Checking and Replacing Wiper Blades.....	543
Front.....	154
WMA	218, 261, 273
Worn Tires	545



31T6Z610
OM-06200
00X31-T6Z-6100

owners.honda.com (U.S.)
myhonda.ca (Canada)

2018 Honda Ridgeline Owner's Manual
©2017 Honda Motor Co., Ltd. — All Rights Reserved

Printed in U.S.A.