

TABLE OF CONTENTS

1	Before driving	Adjusting and operating features such as door locks, mirrors, and steering column.
2	When driving	Driving, stopping, and safe-driving information.
3	Interior and exterior features	Air conditioning and audio systems, as well as other interior features for a comfortable driving experience.
4	Maintenance and care	Cleaning and protecting your vehicle, performing do-it-yourself maintenance, and maintenance information.
5	When trouble arises	What to do if the vehicle needs to be towed, gets a flat tire, or is involved in an accident.
6	Vehicle specifications	Detailed vehicle information.
7	For owners	Reporting safety defects for U.S. owners, seat belt instructions for Canadian owners and camper information.
	Index	Alphabetical listing of information contained in this manual.

1 Before driving

1-1. Key information
 Keys 42

1-2. Opening, closing and locking the doors
 Wireless remote control 44
 Side doors 47
 Tailgate 52

1-3. Adjustable components (seats, mirrors, steering wheel)
 Front seats 60
 Rear seats (Double Cab and CrewMax models) 65
 Driving position memory (driver's seat) 70
 Head restraints 73
 Seat belts 77
 Steering wheel (manually adjustable type) 85
 Steering wheel (power-adjustable type) 87
 Anti-glare inside rear view mirror 88
 Outside rear view mirrors 91

1-4. Opening and closing the windows and moon roof
 Power windows 96
 Back window 100
 Power back window 101
 Moon roof 104

1-5. Refueling
 Opening the fuel tank cap... 109

1-6. Theft deterrent system
 Engine immobilizer system 114
 Alarm 116

1-7. Safety information
 Correct driving posture 118
 SRS airbags 120
 Front passenger occupant classification system 136
 Child restraint systems 143
 Installing child restraints 149

2 When driving

2-1. Driving procedures
 Driving the vehicle 174
 Engine (ignition) switch 183
 Automatic transmission 186
 Turn signal lever 191
 Parking brake 192
 Horn 193

2-2. Instrument cluster
 Gauges and meters 194
 Indicators and warning lights 200
 Multi-information display 204
 Accessory meter 210

2-3. Operating the lights and wipers

Headlight switch..... 213
Fog light switch 217
Windshield wipers and washer 218

2-4. Using other driving systems

Cruise control..... 221
Intuitive parking assist..... 224
Rear view monitor system... 230
Four-wheel drive system..... 236
AUTO LSD system..... 240
Driving assist systems 243

2-5. Driving information

Off-road precautions 250
Cargo and luggage 255
Vehicle load limits 258
Winter driving tips 260
Trailer towing 264
Dinghy towing 285

Interior and exterior features

3-1. Using the air conditioning system and defogger

Automatic air conditioning system 288
Manual air conditioning system 297
Outside rear view mirror defoggers and front windshield wiper de-icer (if equipped on Regular Cab and Double Cab models) 305

Back window, outside rear view mirror defoggers and front windshield wiper de-icer (if equipped on CrewMax models) 307

3-2. Using the audio system

Audio system types 310
Using the radio 314
Using the CD player 322
Playing MP3 and WMA discs 331
Operating an iPod® 339
Operating a USB memory 345
Optimal use of the audio system..... 352
Using the AUX adapter..... 356
Using the steering wheel audio switches..... 358

3-3. Using the Bluetooth® audio system

Bluetooth® audio system.... 361
Using the Bluetooth® audio system 364
Operating a Bluetooth® enabled portable player.... 369
Setting up a Bluetooth® enabled portable player.... 371
Bluetooth® audio system setup 376

3-4. Using the rear audio/video system

Rear seat entertainment system..... 377

Using the DVD player (DVD video)..... 386

Using the DVD player (video CD)..... 395

Using the DVD player (audio CD/CD text)..... 398

Using the DVD player (MP3 discs) 400

Using the video mode 403

Changing the Setup Menu settings..... 405

3-5. Using the hands-free phone system (for cellular phone)

Hands-free phone system features 413

Using the hands-free phone system..... 417

Making a phone call 425

Setting a cellular phone..... 429

Security and system setup 433

Using the phone book 436

3-6. Using the interior lights

Interior lights list 442

- Personal/interior light main switch 443
- Personal/interior lights..... 444
- Cargo lamp main switch... 446

3-7. Using the storage features

List of storage features 447

- Glove boxes 449
- Console box 450
- Card holder..... 453
- Map holder 456
- Pen holder 459
- Tissue pocket 461
- Overhead console 463
- Front cup holders 464
- Rear cup holders 466
- Bottle holders 467
- Auxiliary boxes 469
- Storage box 471

3-8. Other interior features

Sun visors..... 474

Vanity mirrors 475

Clock..... 476

Outside temperature display 477

Ashtray 479

Cigarette lighter 481

Power outlets (12V DC)..... 482

Power outlets (115V AC) 487

Seat heaters 491

Seat heaters and ventilators 493

Armrest (CrewMax models only).... 495

Seatback table 496

Floor mat 497

Luggage compartment features 498

Garage door opener 501

Compass 506

4-1. Maintenance and care

- Cleaning and protecting the vehicle exterior..... 512
- Cleaning and protecting the vehicle interior..... 514

4-2. Maintenance

- Maintenance requirements..... 517
- General maintenance..... 519
- Emission inspection and maintenance (I/M) programs..... 522

4-3. Do-it-yourself maintenance

- Do-it-yourself service precautions 523
- Hood 527
- Engine compartment..... 528
- Tires 542
- Tire inflation pressure 549
- Wheels 553
- Air conditioning filter..... 555
- Wireless remote control battery..... 558
- Checking and replacing fuses 560
- Light bulbs..... 571

5-1. Essential information

- Emergency flashers..... 584
- If your vehicle needs to be towed..... 585
- If you think something is wrong 591
- Fuel pump shut off system..... 592
- Event data recorder..... 593

5-2. Steps to take in an emergency

- If a warning light turns on or a warning buzzer sounds... 595
- If a warning message is displayed (vehicles with multi-information display) 604
- If you have a flat tire 608
- If the engine will not start.... 625
- If the shift lever cannot be shifted from P 627
- If you lose your keys..... 630
- If the vehicle battery is discharged..... 631
- If your vehicle overheats 634
- If the vehicle becomes stuck..... 637
- If your vehicle has to be stopped in an emergency 638

6 Vehicle specifications

6-1. Specifications

Maintenance data
(fuel, oil level, etc.) 640

Fuel information 669

Tire information 673

6-2. Customization

Customizable features 684

Items to initialize..... 687

7 For owners

Reporting safety defects
for U.S. owners 690

Seat belt instructions for
Canadian owners
(in French)..... 691

Camper information..... 693

Index

Abbreviation list..... 706

Alphabetical index 708

What to do if... 718

1

2

3

4

5

6

7

► Regular Cab models

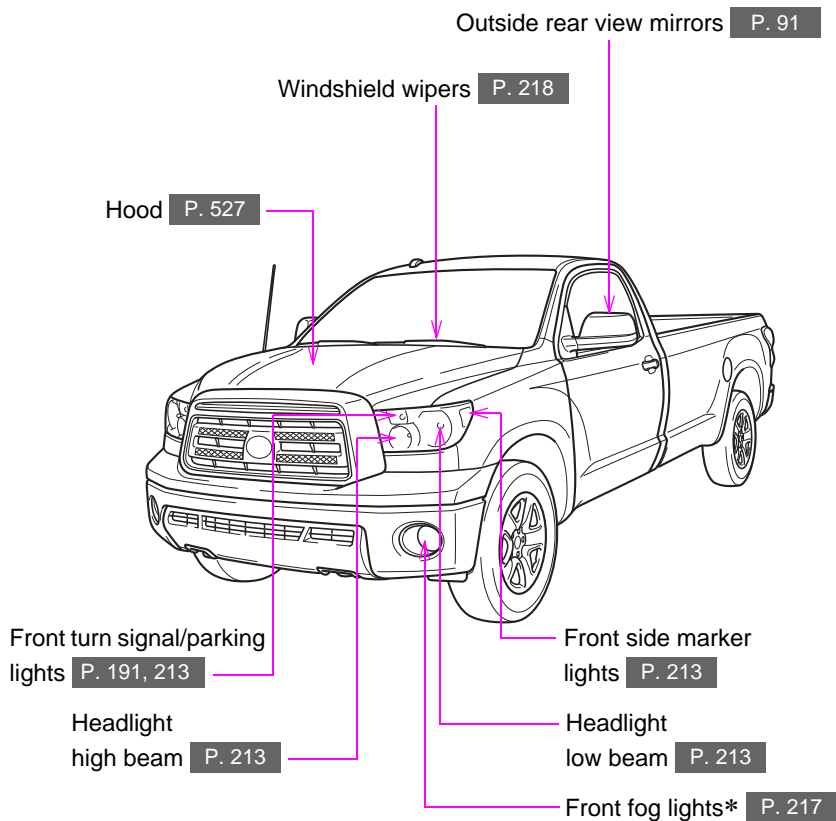

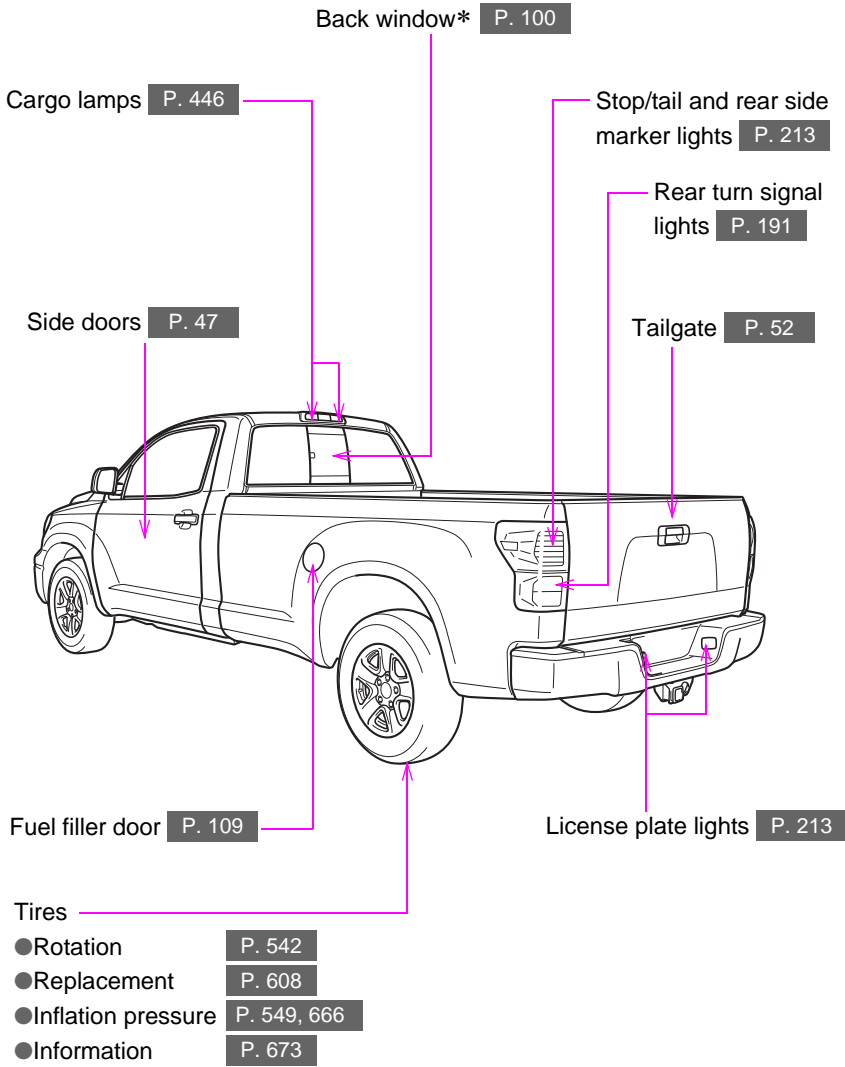

*: If equipped

► Double Cab models

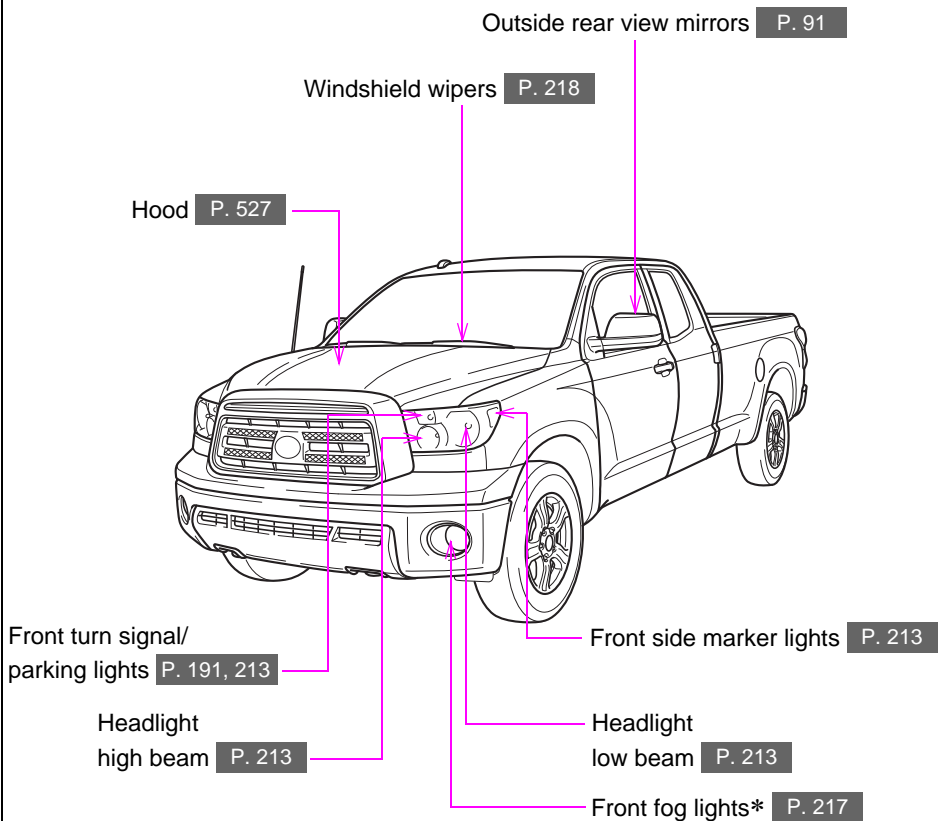

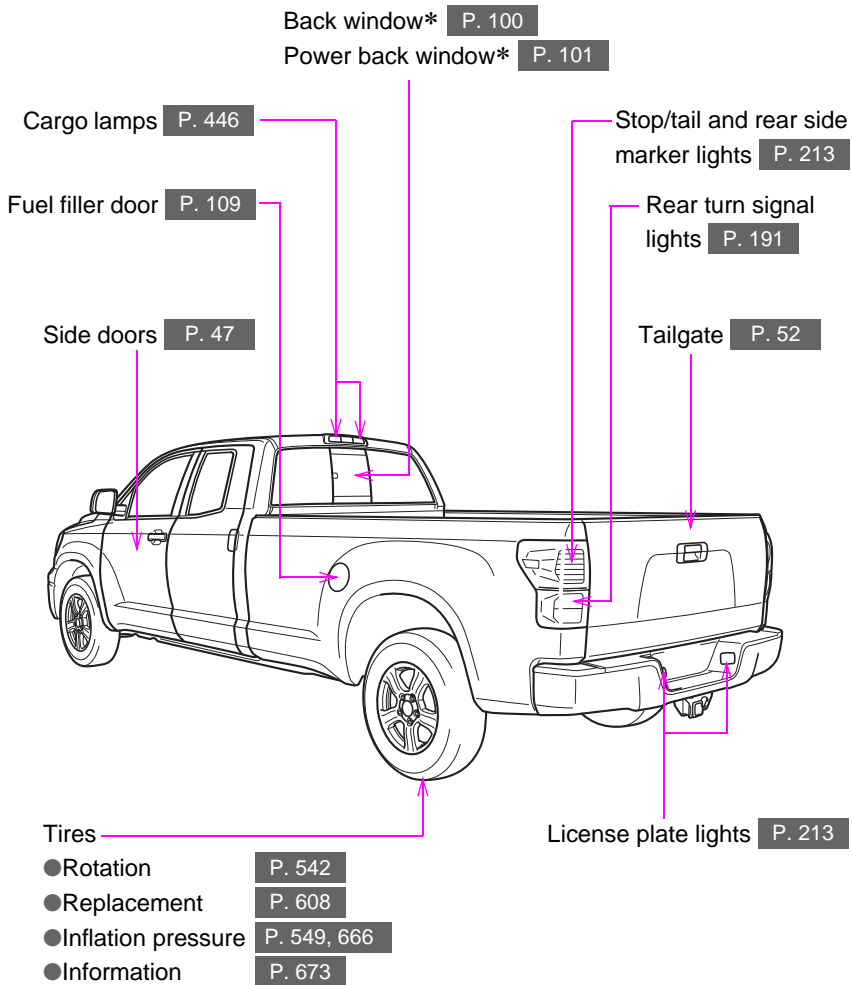

*: If equipped

► CrewMax models

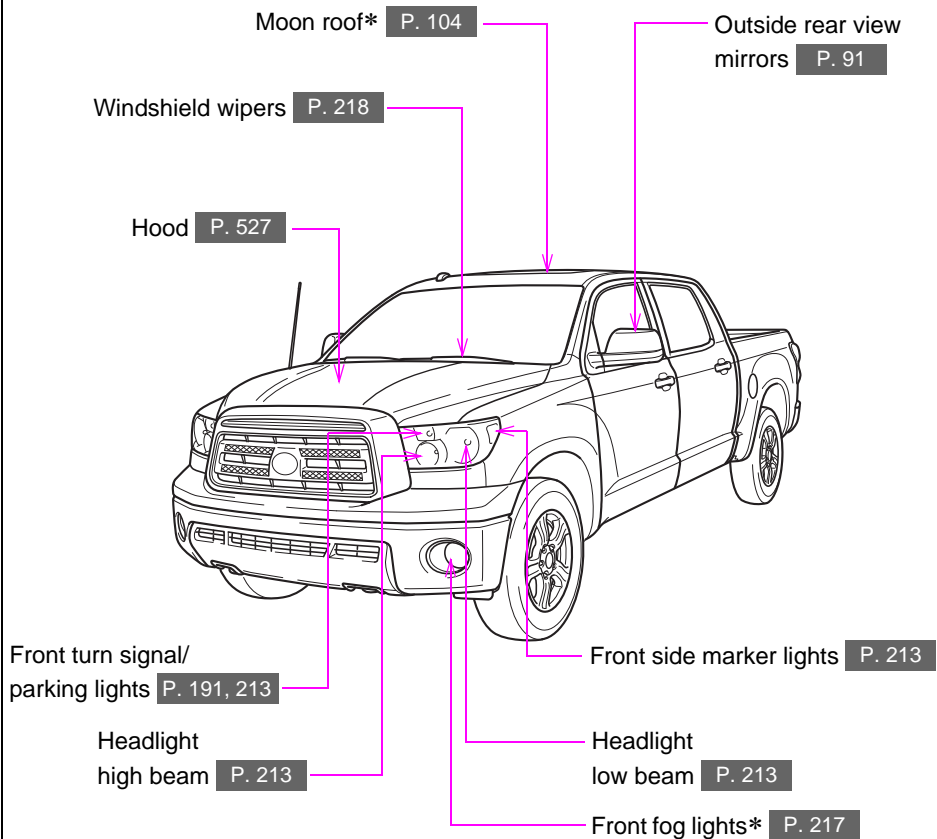

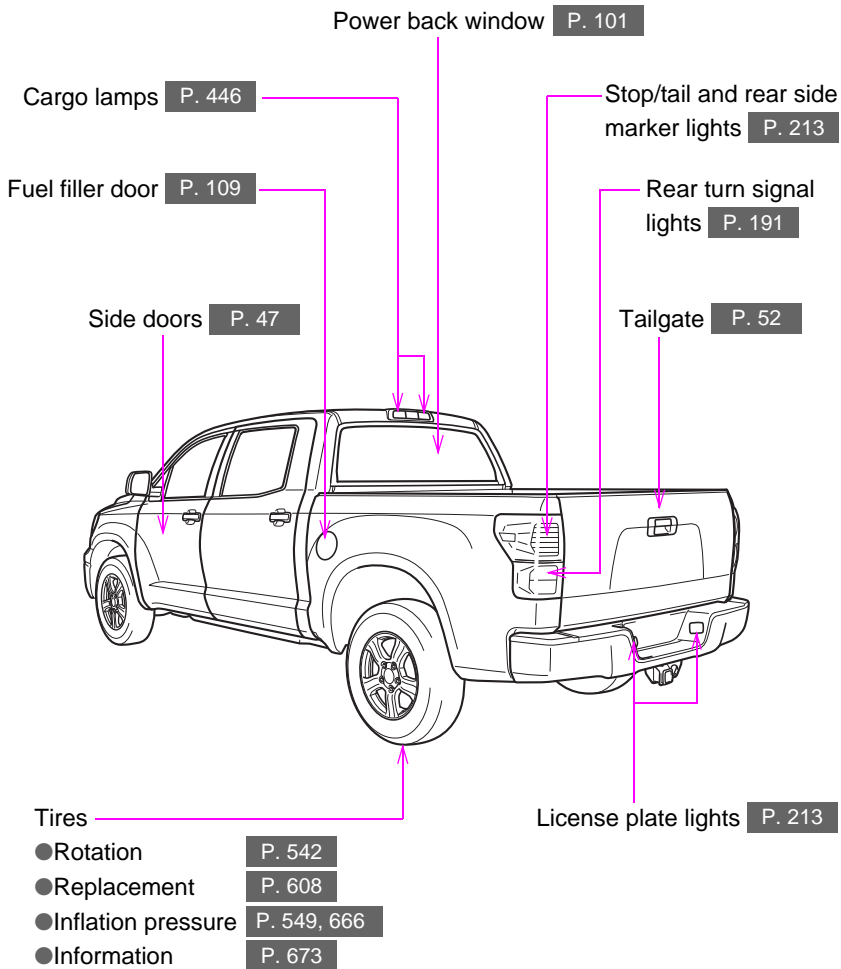

*: If equipped

► Front separated type seats

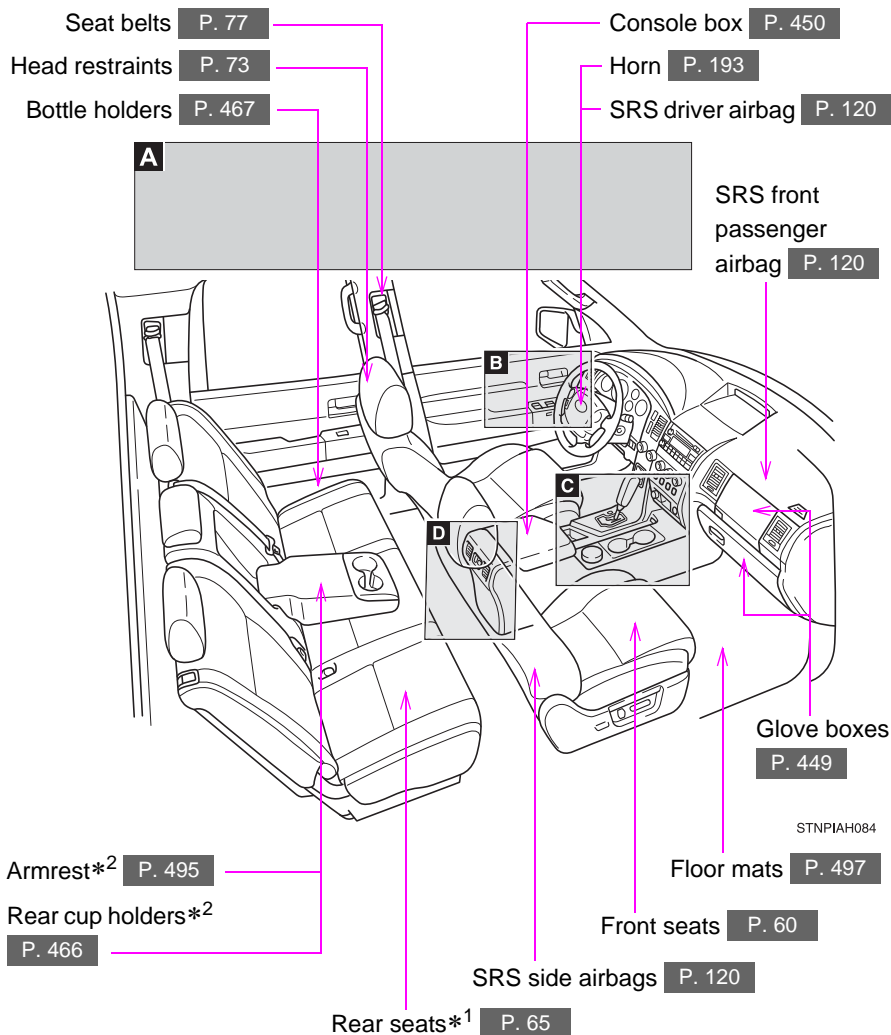

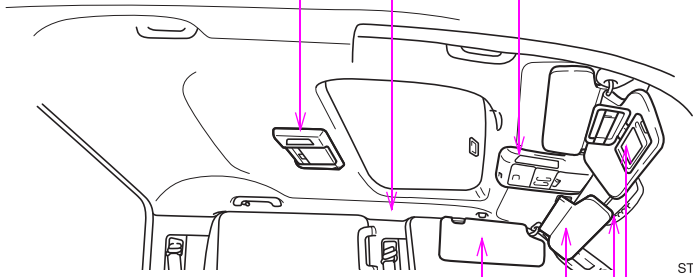
A**► Type A**SRS curtain shield airbags **P. 120**Personal light*²/
interior light*⁵ **P. 444**Rear seat entertainment
system*⁴ **P. 377**Personal/interior
lights **P. 444**Moon roof switches*⁴
P. 104Overhead console
P. 463

STNPIAH002

Sun visors **P. 474**Anti-glare inside rear view mirror **P. 88**Rear view monitor system*³ **P. 230**Compass*³ **P. 506**Garage door opener switches*³ **P. 501**Vanity mirrors*³ **P. 475**

*¹: Double Cab and CrewMax models *⁴: If equipped on CrewMax models
 *²: CrewMax models *⁵: Double Cab models
 *³: If equipped

A

► **Type B (If equipped on Double Cab and CrewMax models)**

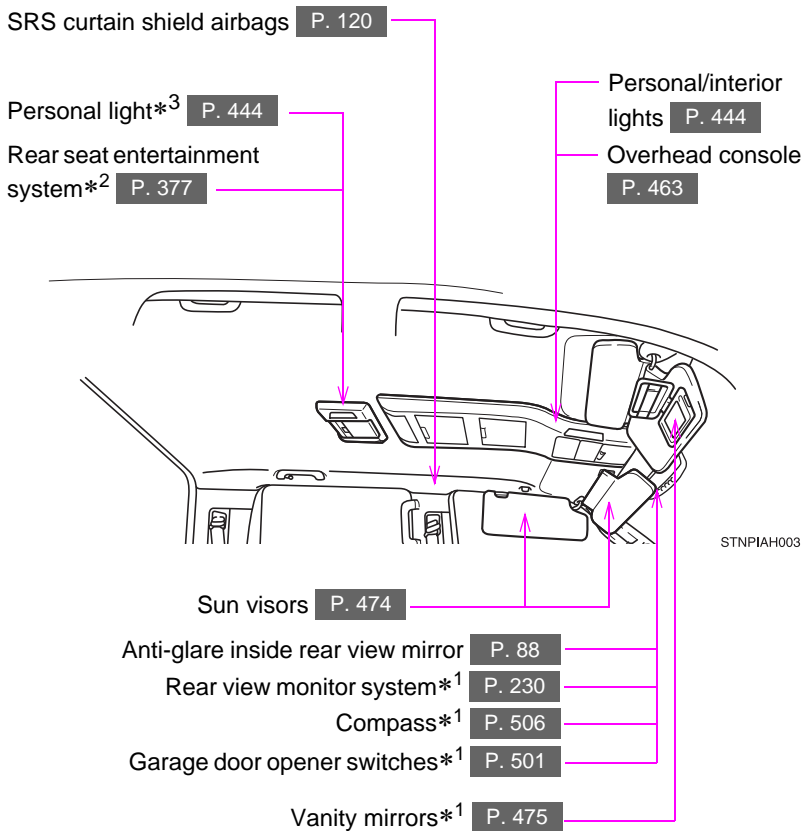

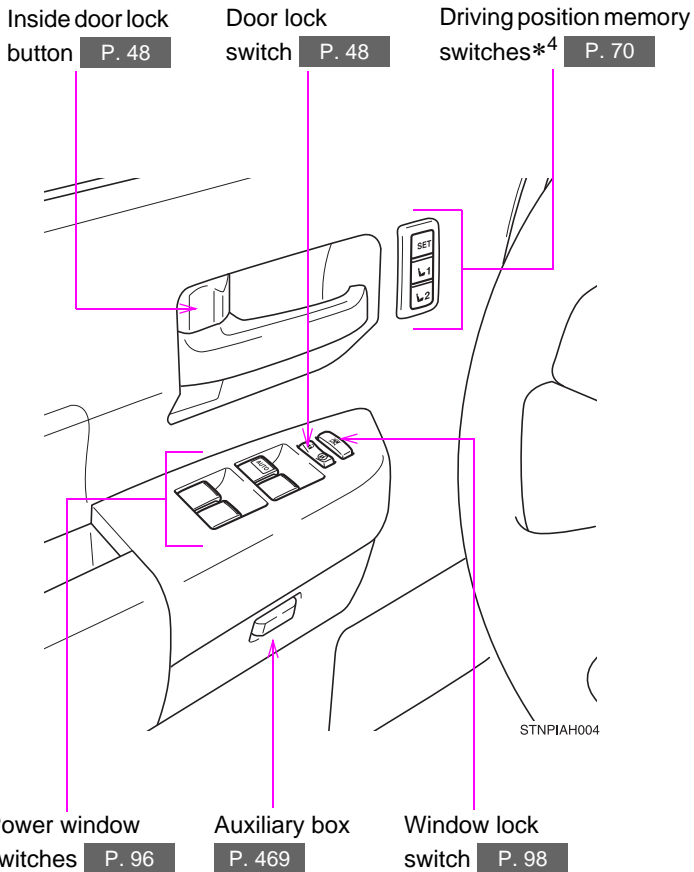
B

*1: If equipped

*2: If equipped on CrewMax models

*3: CrewMax models

*4: If equipped on Double Cab and CrewMax models

C

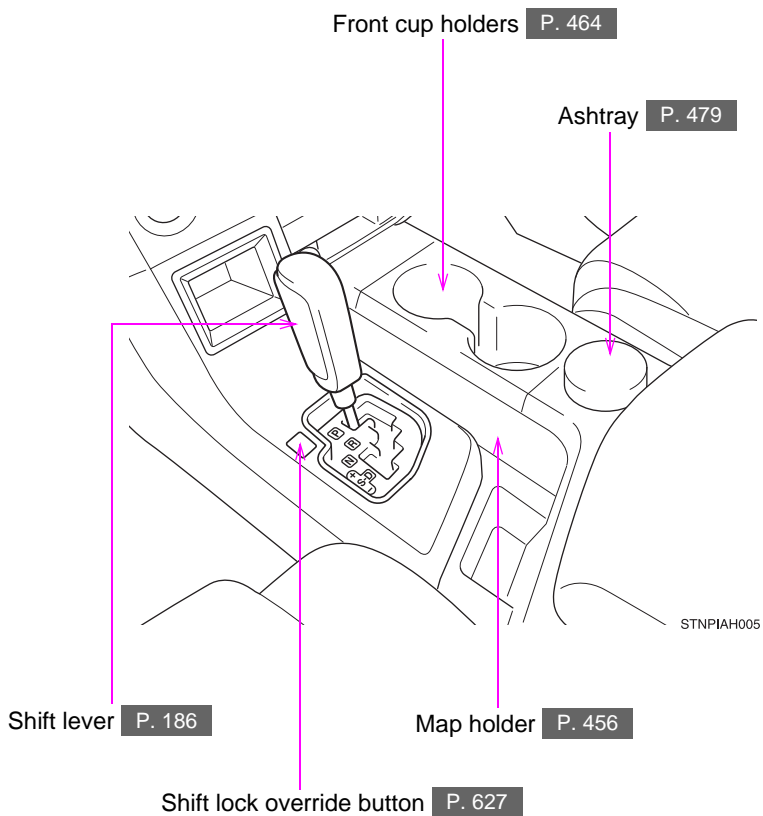

D

► **Double Cab models**

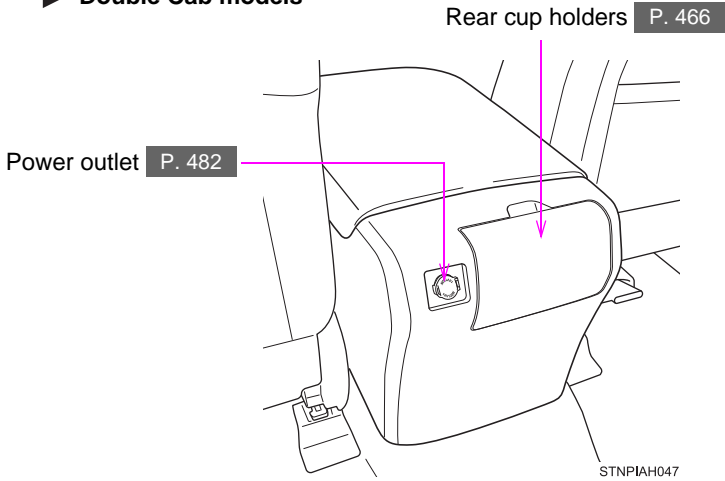

► **CrewMax models**

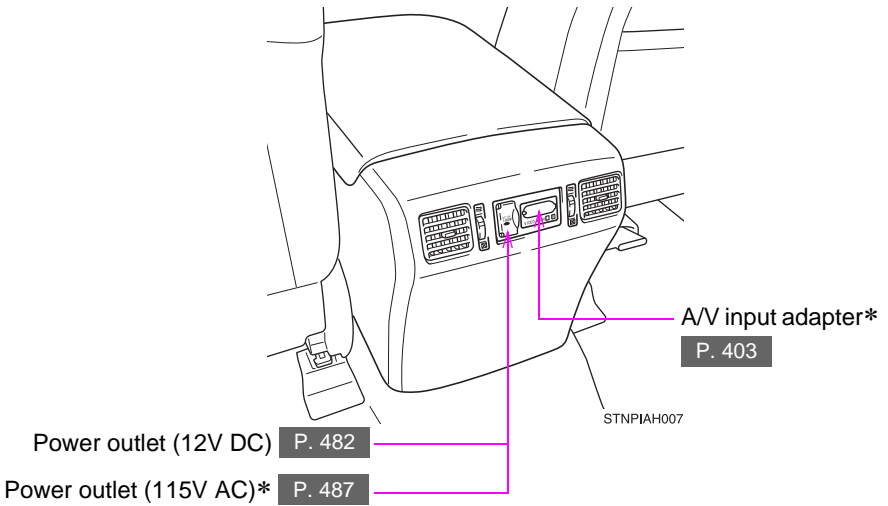

*: If equipped

► Front bench type seat

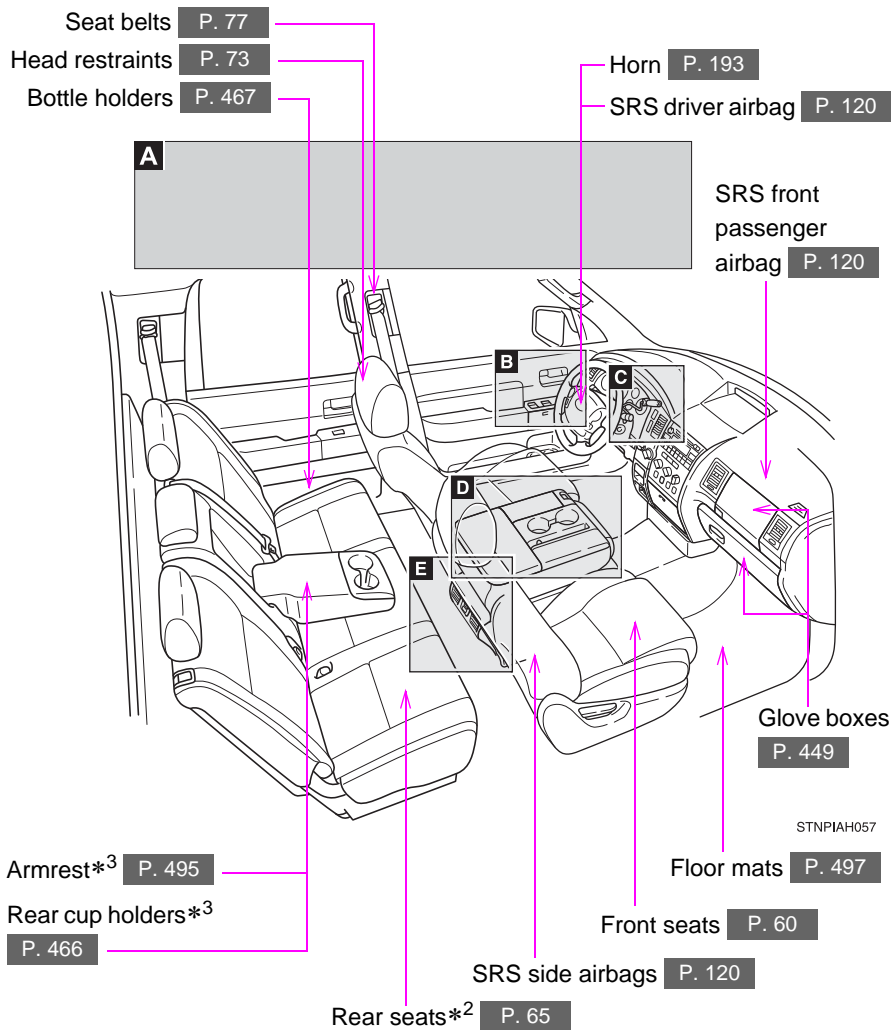

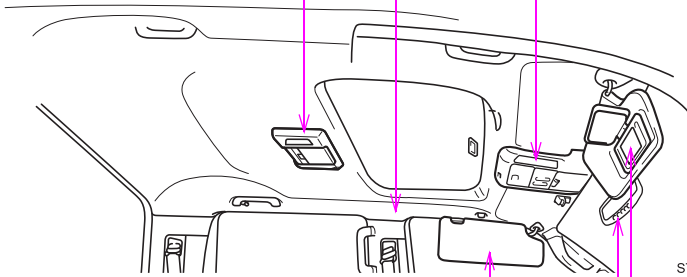
A**► Type A**SRS curtain shield airbags **P. 120**Personal light*³/
interior light*⁵ **P. 444**Rear seat entertainment
system*⁴ **P. 377**Personal/interior
lights **P. 444**Moon roof switches*⁴
P. 104Overhead console
P. 463

STNPIAH046

Sun visors **P. 474**Anti-glare inside rear view mirror **P. 88**Rear view monitor system*¹ **P. 230**Compass*¹ **P. 506**Garage door opener switches*¹ **P. 501**Vanity mirrors*¹ **P. 475***¹: If equipped*²: Double Cab and CrewMax models*³: CrewMax models*⁴: If equipped on CrewMax models*⁵: Double Cab models

A

► **Type B (If equipped on Double Cab and CrewMax models)**

SRS curtain shield airbags P. 120

Personal light*³ P. 444

Rear seat entertainment system*² P. 377

Personal/interior lights P. 444

Overhead console P. 463

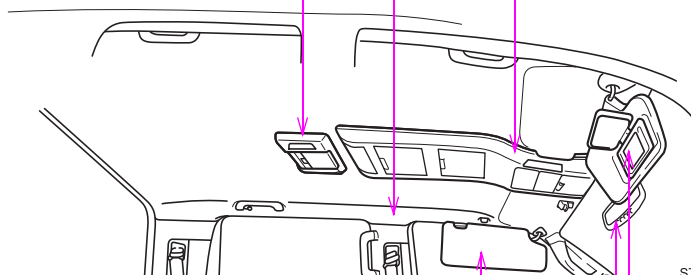

STNPIAH045

Sun visors P. 474

Anti-glare inside rear view mirror P. 88

Rear view monitor system*¹ P. 230

Compass*¹ P. 506

Garage door opener switches*¹ P. 501

Vanity mirrors*¹ P. 475

B

Inside door lock
button P. 48

Door lock
switch*¹ P. 48

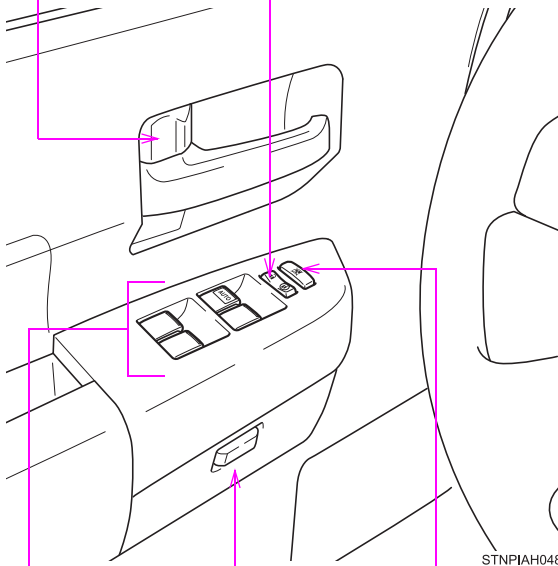

Power window
switches*¹ P. 96

Auxiliary box*¹
P. 469

Window lock
switch*¹ P. 98

*¹: If equipped

*²: If equipped on CrewMax models

*³: CrewMax models

C

Shift lock override
button **P. 627**

Shift lever **P. 186**

TOW HAUL switch*
P. 189

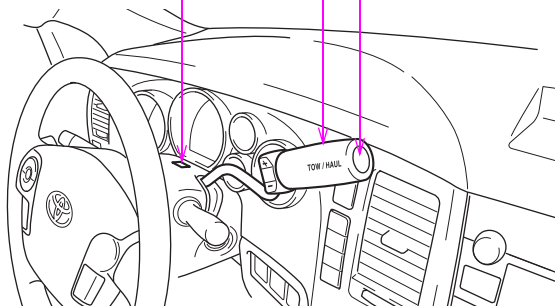

STNPIAH058

D

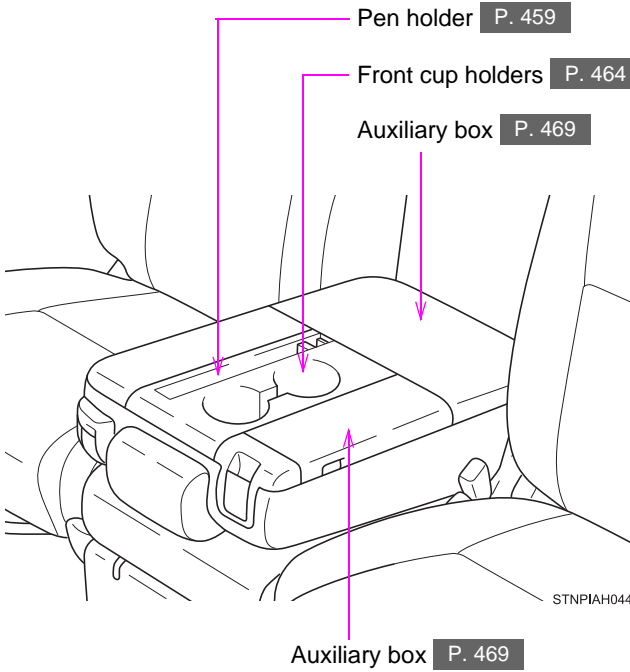

*: If equipped

E

► Double Cab models

Power outlet P. 482

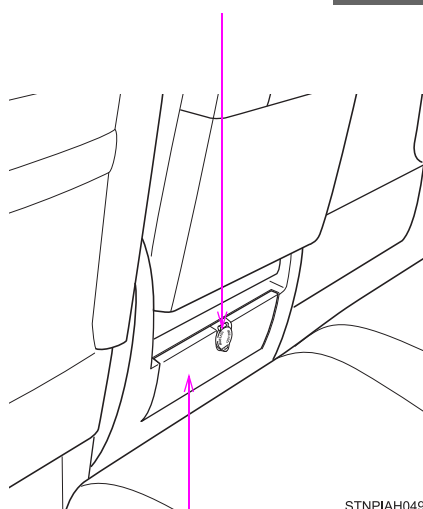

STNPIAH049

Rear cup holders P. 466

E

► CrewMax models

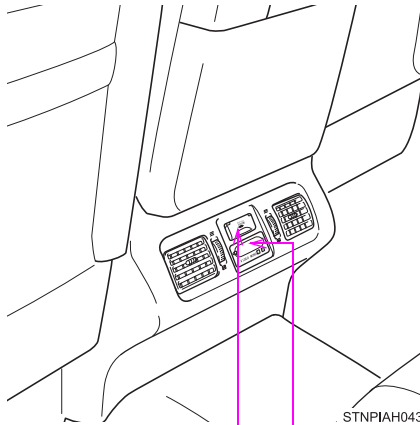

Power outlet (12V DC) P. 482

Power outlet (115V AC)* P. 487

A/V input adapter*

P. 403

*: If equipped

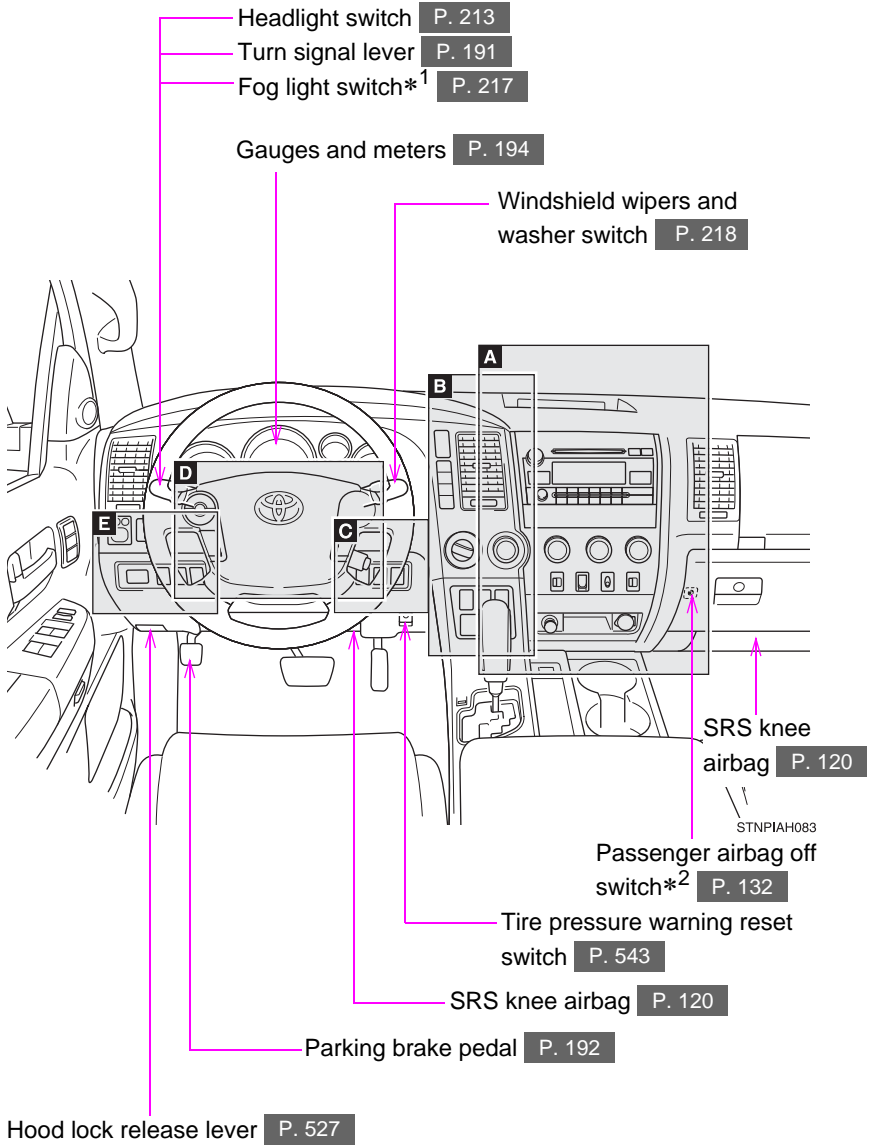

A**► Vehicles with manual air conditioning system (front separated type seats)**

Outside rear view mirror defogger switch*³/ outside rear view mirror defogger and front windshield wiper de-icer switch*³ **P. 305**

Back window defogger switch*⁴/ back window defogger and outside rear view mirror defogger switch*⁵/ back window defogger, outside rear view mirror defogger and front windshield wiper de-icer switch*⁵ **P. 307**

Accessory meter **P. 210**

Security indicator*¹ **P. 114, 116**

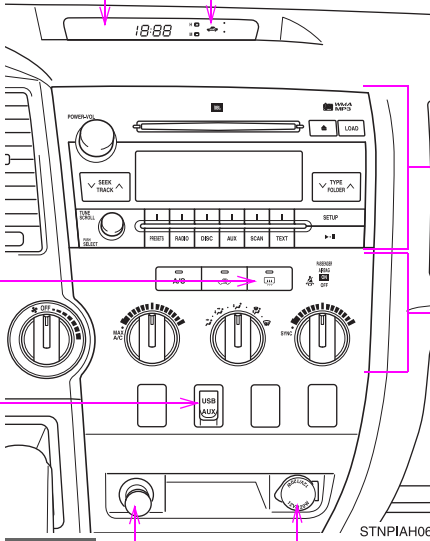

Audio system **P. 310**

Navigation system*

Air conditioning system **P. 297**

AUX adapter **P. 356**

iPod®*¹ **P. 339**

USB memory*¹ **P. 345**

Power outlet **P. 482**

Cigarette lighter **P. 481**

*: Refer to "Navigation System Owner's Manual"

*³: If equipped on Regular Cab and Double Cab models

*¹: If equipped

*⁴: CrewMax models

*²: Regular Cab models

*⁵: If equipped on CrewMax models

A

► **Vehicles with manual air conditioning system (front bench type seat)**

Outside rear view mirror defogger switch*²/ outside rear view mirror defogger and front windshield wiper de-icer switch*² **P. 305**

Back window defogger switch*³/ back window defogger and outside rear view mirror defogger switch*⁴/ back window defogger, outside rear view mirror defogger and front windshield wiper de-icer switch*⁴ **P. 307**

Accessory meter **P. 210**

Security indicator*¹ **P. 114, 116**

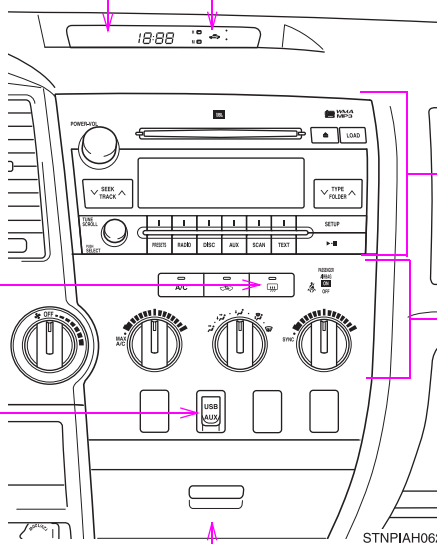

Audio system **P. 310**
Navigation system*

Air conditioning system **P. 297**

AUX adapter **P. 356**

iPod®*¹ **P. 339**

USB memory*¹ **P. 345**

Bottle holders **P. 467**

A

► **Vehicles with an automatic air conditioning system**

Outside rear view mirror defogger switch*⁵/ outside rear view mirror defogger and front windshield wiper de-icer switch*⁶ P. 305

Back window defogger and outside rear view mirror defogger switch*³/ back window defogger, outside rear view mirror defogger and front windshield wiper de-icer switch*⁴ P. 307

Accessory meter P. 210

Security indicator P. 114, 116

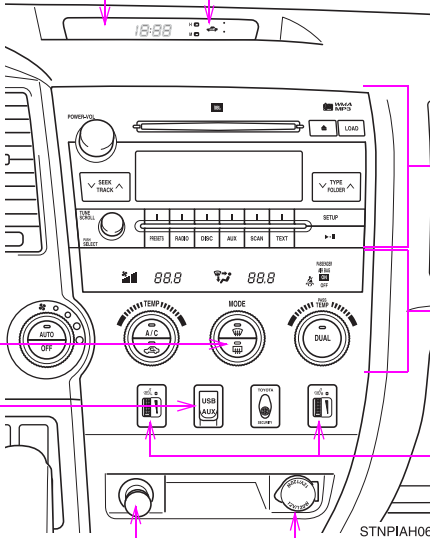

Audio system P. 310

Navigation system*

Air conditioning system P. 288

Seat heater switches*¹ P. 491

Seat heater and ventilator switches*¹ P. 493

AUX adapter P. 356

iPod®*¹ P. 339

USB memory*¹ P. 345

Power outlet P. 482

Cigarette lighter P. 481

*: Refer to "Navigation System Owner's Manual"

*¹: If equipped

*²: If equipped on Regular Cab and Double Cab models

*³: CrewMax models

*⁴: If equipped on CrewMax models

*⁵: Double Cab models

*⁶: If equipped on Double Cab models

B

► Front separated type seats

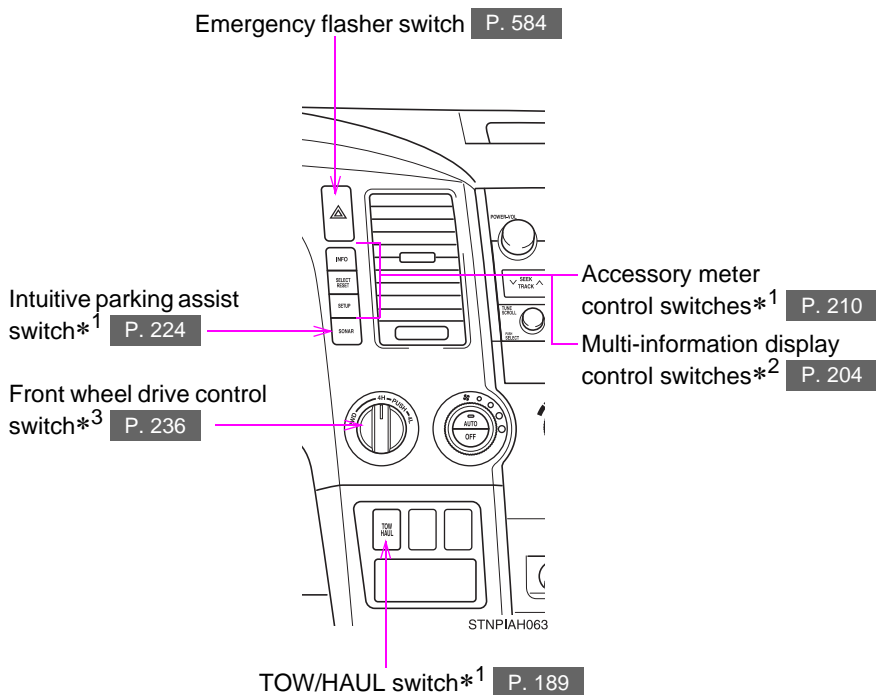

B

► Front bench type seat

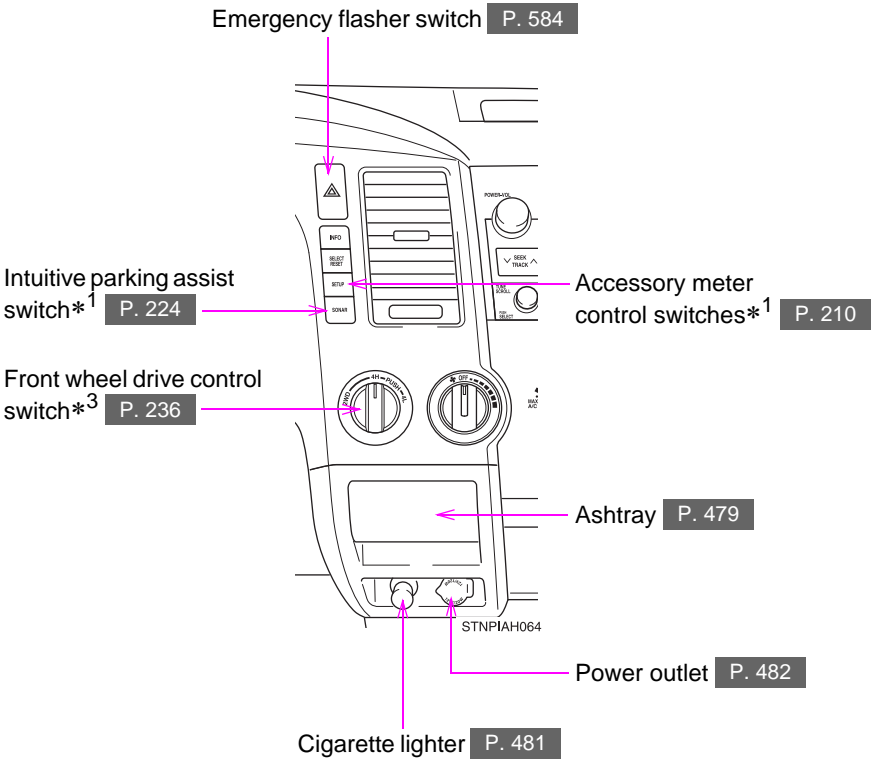

*¹: If equipped

*³: 4WD models

*²: Vehicles with multi-information display

C

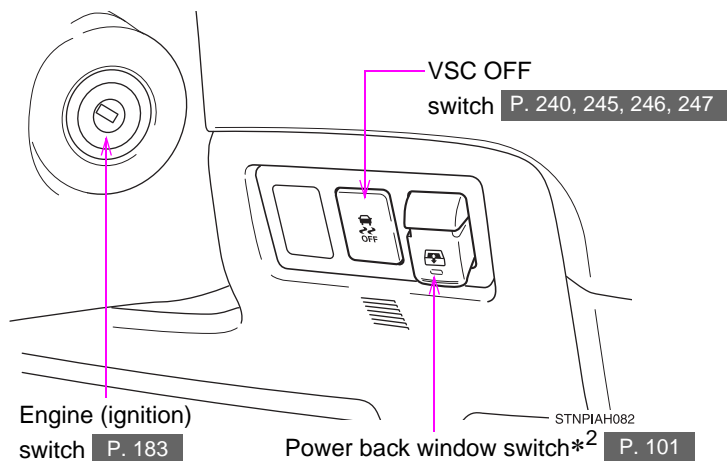

D

Audio remote control switches*1 P. 358

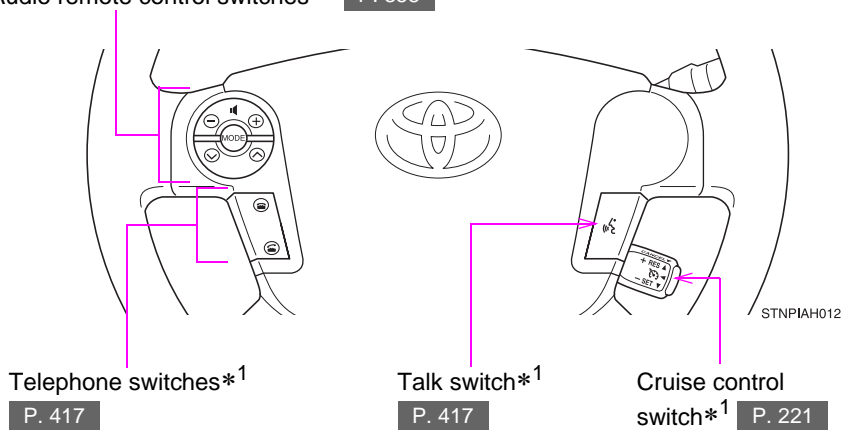

E

Personal/interior light
main switch P. 443

Outside rear view mirror
switches*¹ P. 91

Instrument panel light
control dial P. 199

Tilt and telescopic steering
control switch*⁵ P. 87

Cargo lamp main switch P. 446

Headlight leveling dial*¹
P. 214

RSCA OFF switch*⁶ P. 134

Tilt steering lock release lever*³/
tilt and telescopic steering lock
release lever*⁴ P. 85

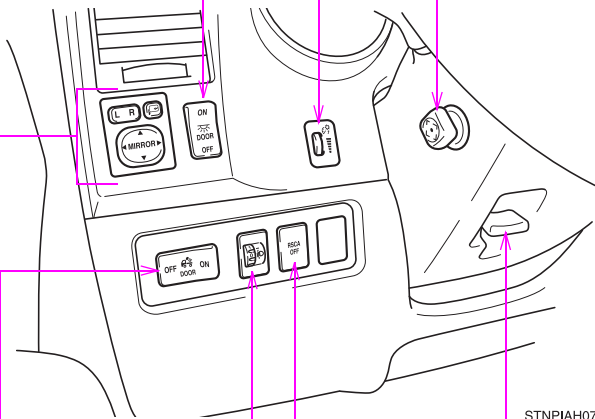

STNPIAH077

*¹: If equipped

*²: If equipped on Double Cab and CrewMax
models

*³: Front bench type seat

*⁴: Vehicles without driving position memory
(front separated type seats)

*⁵: Vehicles with driving position memory

*⁶: 4WD models only

For your information

Main Owners Manual

Please note that this manual applies to all models and explains all equipment, including options. Therefore, you may find some explanations for equipment not installed on your vehicle.

All specifications provided in this manual are current at the time of printing. However, because of the Toyota policy of continual product improvement, we reserve the right to make changes at any time without notice.

Depending on specifications, the vehicle shown in the illustrations may differ from your vehicle in terms of equipment.

Noise from under vehicle after turning off the engine

Approximately five hours after the engine is turned off, you may hear sound coming from under the vehicle for several minutes. This is the sound of a fuel evaporation leakage check and, it does not indicate a malfunction.

Accessories, spare parts and modification of your Toyota

A wide variety of non-genuine spare parts and accessories for Toyota vehicles are currently available in the market. You should know that Toyota does not warrant these products and is not responsible for their performance, repair, or replacement, or for any damage they may cause to, or adverse effect they may have on, your Toyota vehicle.

This vehicle should not be modified with non-genuine Toyota products. Modification with non-genuine Toyota products could affect its performance, safety or durability, and may even violate governmental regulations. In addition, damage or performance problems resulting from the modification may not be covered under warranty.

Installation of a mobile two-way radio system

As the installation of a mobile two-way radio system in your vehicle could affect electronic systems such as the multiport fuel injection system/sequential multiport fuel injection system, cruise control system, anti-lock brake system, SRS airbag system and seat belt pretensioner system, be sure to check with your Toyota dealer for precautionary measures or special instructions regarding installation.

Scrapping your Toyota

The SRS airbag and seat belt pretensioner devices in your Toyota contain explosive chemicals. If the vehicle is scrapped with the airbags and seat belt pretensioners left as they are, this may cause an accident such as fire. Be sure to have the systems of the SRS airbag and seat belt pretensioner removed and disposed of by a qualified service shop or by your Toyota dealer before you scrap your vehicle.

Perchlorate Material

Special handling may apply,
See www.dtsc.ca.gov/hazardouswaste/perchlorate.

Your vehicle has components that may contain perchlorate. These components may include airbag, seat belt pretensioners, and wireless remote control batteries.



CAUTION

■ **General precautions while driving**

Driving under the influence: Never drive your vehicle when under the influence of alcohol or drugs that have impaired your ability to operate your vehicle. Alcohol and certain drugs delay reaction time, impair judgment and reduce coordination, which could lead to an accident that could result in death or serious injury.

Defensive driving: Always drive defensively. Anticipate mistakes that other drivers or pedestrians might make and be ready to avoid accidents.

Driver distraction: Always give your full attention to driving. Anything that distracts the driver, such as adjusting controls, talking on a cellular phone or reading can result in a collision with resulting death or serious injury to you, your occupants or others.

■ **General precaution regarding children's safety**

Never leave children unattended in the vehicle, and never allow children to have or use the key.

Children may be able to start the vehicle or shift the vehicle into neutral. There is also a danger that children may injure themselves by playing with the cigarette lighter, the windows, or other features of the vehicle. In addition, heat build-up or extremely cold temperatures inside the vehicle can be fatal to children.

Symbols used throughout this manual

Cautions & Notices

CAUTION

This is a warning against anything which may cause injury to people if the warning is ignored. You are informed about what you must or must not do in order to reduce the risk of injury to yourself and others.

NOTICE

This is a warning against anything which may cause damage to the vehicle or its equipment if the warning is ignored. You are informed about what you must or must not do in order to avoid or reduce the risk of damage to your Toyota and its equipment.

Symbols used in illustrations



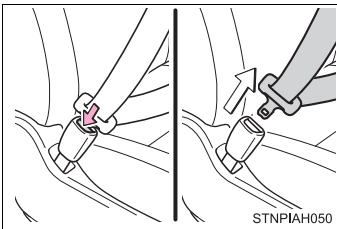

Safety symbol

The symbol of a circle with a slash through it means “Do not”, “Do not do this”, or “Do not let this happen”.



Arrows indicating operations

-  Indicates the action (pushing, turning, etc.) used to operate switches and other devices.
-  Indicates the outcome of an operation (e.g. a lid opens).

Before driving

1

- 1-1. Key information**
 - Keys 42
- 1-2. Opening, closing and locking the doors**
 - Wireless remote control 44
 - Side doors..... 47
 - Tailgate 52
- 1-3. Adjustable components (seats, mirrors, steering wheel)**
 - Front seats 60
 - Rear seats (Double Cab and CrewMax models)..... 65
 - Driving position memory (driver's seat) 70
 - Head restraints..... 73
 - Seat belts 77
 - Steering wheel (manually adjustable type) 85
 - Steering wheel (power-adjustable type) ... 87
 - Anti-glare inside rear view mirror 88
 - Outside rear view mirrors... 91
- 1-4. Opening and closing the windows and moon roof**
 - Power windows 96
 - Back window 100
 - Power back window 101
 - Moon roof..... 104
- 1-5. Refueling**
 - Opening the fuel tank cap 109
- 1-6. Theft deterrent system**
 - Engine immobilizer system 114
 - Alarm..... 116
- 1-7. Safety information**
 - Correct driving posture..... 118
 - SRS airbags..... 120
 - Front passenger occupant classification system 136
 - Child restraint systems..... 143
 - Installing child restraints... 149

Keys

The following keys are provided with the vehicle.

► **Vehicles without engine immobilizer system**

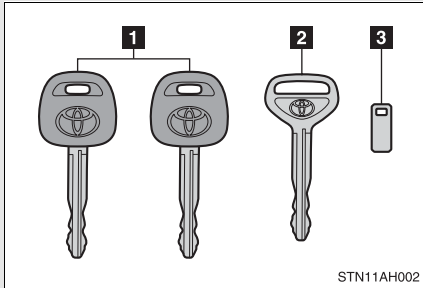

- 1** Master keys
- 2** Valet key
- 3** Key number plate

► **Vehicles with engine immobilizer system**

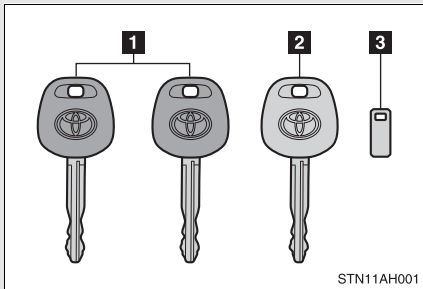

- 1** Master keys
- 2** Valet key
- 3** Key number plate

■ **When required to leave a key to the vehicle with a parking attendant**

Lock the glove box as circumstances demand. (→P. 449)

Carry the master key for your own use and leave the valet key only with the attendant.

■ **Key number plate**

Keep the plate in a safe place such as your wallet, not in the vehicle. In the event that a key is lost, a new key can be made by your Toyota dealer using the key number plate. (→P. 630)

**NOTICE****■ To prevent key damage (vehicles with engine immobilizer system)**

- Do not subject the keys to strong shocks, expose them to high temperatures by placing them in direct sunlight, or get them wet.
- Do not expose the keys to electromagnetic materials or attach any material that blocks electromagnetic waves to the key surface.

1-2. Opening, closing and locking the doors Wireless remote control*

The wireless remote control can be used to lock and unlock the vehicle from outside the vehicle.

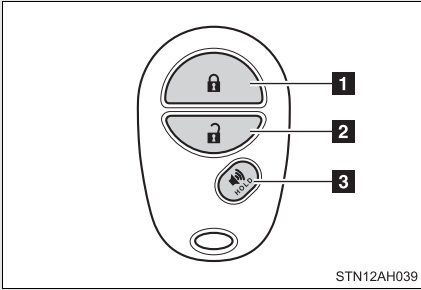

1 Locks all doors

2 Unlocks all doors

Pressing the button unlocks the driver's door. Pressing the button again within 3 seconds unlocks the other doors.

3 Pushing and holding:
Sounds alarm

■ Operation signals

A buzzer sounds and the emergency flashers flash to indicate that the doors have been locked/unlocked. (Locked: Once; Unlocked: Twice)

■ Panic mode



When  is pushed for longer than about one second, an alarm will sound for about 60 seconds and the vehicle lights will flash to deter any person from trying to break into or damage your vehicle.

To stop the alarm, push any button on the wireless remote control.

■ Door lock buzzer

If a door is not fully closed, a buzzer sounds for 10 seconds if an attempt to lock the door is made. Fully close the door to stop the buzzer, and lock the vehicle once more.

*: If equipped

■ Wireless remote control battery depletion

The standard battery life is 1 to 2 years. (The battery becomes depleted even if the wireless remote control is not used.) If the wireless remote control function does not operate, the battery may be depleted. Replace the battery when necessary. (→P. 558)

■ If the wireless remote control does not operate

Locking and unlocking the doors: Use the key. (→P. 47)

■ Security feature

If a door is not opened within approximately 60 seconds after the vehicle is unlocked, the security feature automatically locks the vehicle again.

■ Alarm (if equipped)

Using the wireless remote control to lock the door will set the alarm system. (→P. 116)

■ Conditions affecting operation

The wireless remote control function may not operate normally in the following situations.

- Near a TV tower, radio station, electric power plant, airport or other facility that generates strong radio waves
- When carrying a portable radio, cellular phone or other wireless communication device
- When multiple wireless keys are in the vicinity
- When the wireless key has come into contact with, or is covered by a metallic object
- When a wireless key (that emits radio waves) is being used nearby
- When the wireless key has been left near an electrical appliance such as a personal computer

■ When riding in an aircraft

When bringing a wireless remote control onto an aircraft, make sure you do not press any buttons on the wireless remote control while inside the aircraft cabin. If you are carrying a wireless remote control in your bag etc, ensure that the buttons are not likely to be pressed accidentally. Pressing a button may cause the wireless remote control to emit radio waves that could interfere with the operation of the aircraft.

■ Customization

- That can be configured at Toyota dealer (vehicles without multi-information display)

Settings (e.g. wireless remote control) can be changed.
(Customizable features →P. 684)

- It is possible to change the settings (vehicles with multi-information display) (Feature customization →P. 206)

■ Certification for wireless remote control

- ▶ For vehicles sold in U.S.A.

NOTE:

This device complies with Part 15 of the FCC Rules. Operation is subject to the following two conditions: (1) this device may not cause harmful interference, and (2) this device must accept any interference received, including interference that may cause undesired operation.

- ▶ For vehicles sold in Canada

NOTE:

Operation is subject to the following two conditions: (1) This device may not cause interference, and (2) this device must accept any interference, including interference that may cause undesired operation of the device.

1-2. Opening, closing and locking the doors

Side doors

The vehicle can be locked and unlocked using the wireless remote control, key or door lock switch.

■ Wireless remote control (if equipped)

→P. 44

■ Key

▶ Vehicles without power door lock system

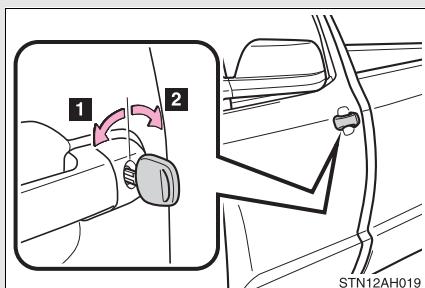

1 Locks the door

2 Unlocks the door

▶ Vehicles with power door lock system

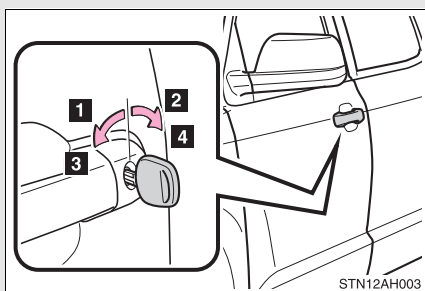

1 Locks all doors

2 Unlocks all doors

Turning the key a single time in the driver's door unlocks the driver's door, and turning the key again unlocks the other doors.

▶ Vehicles with moon roof

3 Closes the moon roof
(turn and hold)

4 Opens the moon roof
(turn and hold)

■ **Door lock switch (if equipped)**

▶ **Driver's door lock switch**

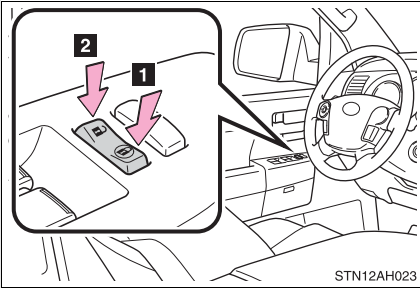

- 1 Locks all doors
- 2 Unlocks all doors

▶ **Passenger's door lock switch**

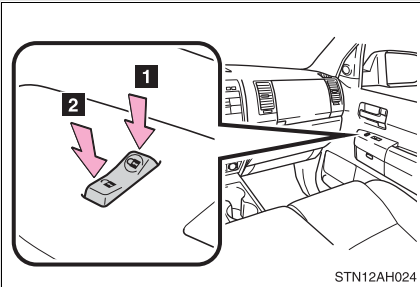

- 1 Locks all doors
- 2 Unlocks all doors

■ **Inside lock button**

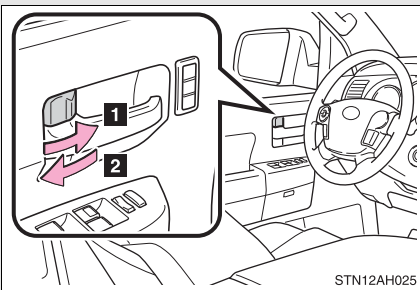

- 1 Locks the door
- 2 Unlocks the door

Pulling the door handle can open the front door even if the lock button is in the lock position.

Locking the front doors from the outside without a key

STEP 1 Move the inside door lock button to the lock position.

STEP 2 Close the door.

► Vehicles with power door lock system

The door cannot be locked if a front door is open and the key is in the engine switch.

Rear door child-protector lock (Double Cab and CrewMax models)

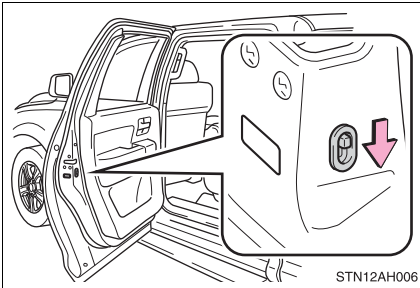

The door cannot be opened from inside the vehicle when the lock is set.

These locks can be set to prevent children from opening the rear doors. Push down on each rear door switch to lock both rear doors.

Automatic door locking and unlocking systems (vehicles with power door lock system)

■ Automatic door locking and unlocking functions

- Locking function: All doors are automatically locked when the vehicle speed goes above about 12 mph (20 km/h).
- Unlocking function: All doors are automatically unlocked when the shift lever is moved to the P position with the engine started.

■ **The following functions can be set or cancelled:**

Function	Operation
Shift position linked door locking function	Shifting the shift lever out of P locks all doors.
Shift position linked door unlocking function	Shifting the shift lever to P unlocks all doors.
Speed linked door locking function	All doors are locked when the vehicle speed is approximately 12 mph (20 km/h) or higher.
Driver's door linked door unlocking function	All doors are unlocked when the driver's door is opened within 10 seconds after turning the engine switch to the ACC or LOCK position.

■ **Setting and canceling the functions**

- ▶ Vehicles with multi-information display

→P. 206

- ▶ Vehicles without multi-information display

To switch between setting and canceling, contact your Toyota dealer.

■ **When locking the doors using the key (vehicles with power door lock system)**

The door cannot be locked if the key is in the engine switch.

■ **Key reminder buzzer**

A buzzer sounds if the driver's door is opened, while the engine switch is in the ACC or LOCK position to remind you to remove the key.

■ **Customization that can be configured at Toyota dealer**

Settings (e.g. door lock) can be changed. (Customizable features →P. 684)

 **CAUTION****■ To prevent an accident**

Observe the following precautions while driving the vehicle.

Failing to do so may result in a door opening and an occupant falling out, resulting in death or serious injury.

- Always use a seat belt.
- Always lock the doors.
- Ensure that all doors are properly closed.
- Do not pull the inside handle of the doors while driving.
The doors may be opened and the passengers are thrown out of the vehicle and it may result in serious injury or death.
Be especially careful for the front doors, as the doors may be opened even if the inside lock buttons are in locked position.
- Double Cab and CrewMax models: Set the rear door child protector locks when children are seated in the rear seats.

Tailgate

The tailgate can be opened using the tailgate handle. The tailgate can be locked/unlocked using a key.

■ Tailgate handle

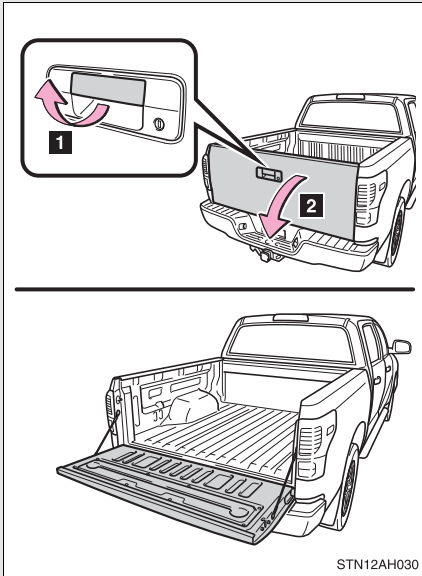

1 Pull the handle

2 Open the tailgate slowly

The support cables will hold the tailgate horizontal.

After closing the tailgate, try pulling it toward you to make sure it is securely locked.

■ Key

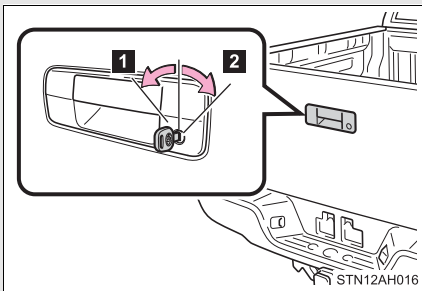

1 Unlock with the master key

2 Lock with the master key

Removing the tailgate

■ Before removing the tailgate (vehicles with rear view monitor system [Type A])

These connector covers are used when removing the tailgate, to prevent the back-up camera wire harness connectors from being contaminated.

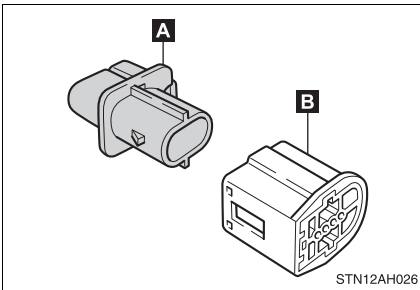

A Tailgate wire harness connector cover

B Frame wire harness connector cover

Store the connector covers in the glove box in a plastic bag when not using.

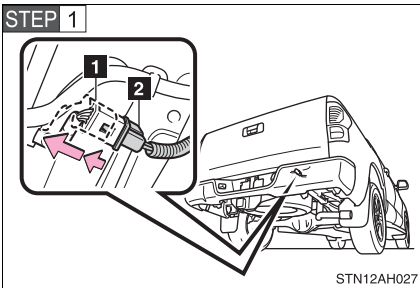

To disconnect the wire harness connectors (**1** and **2**), tailgate wire harness connector and pull apart.

1 Tailgate wire harness connector

2 Frame wire harness connector

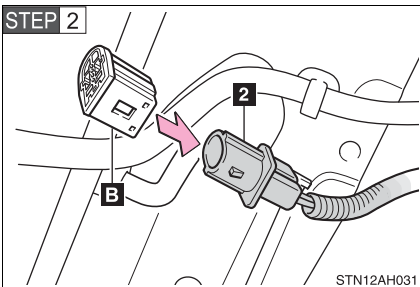

Attach the frame wire harness connector cover to the frame wire harness connector.

B Frame wire harness connector cover

2 Frame wire harness connector

1-2. Opening, closing and locking the doors

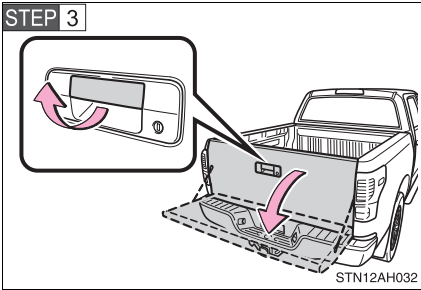

Open the tailgate.

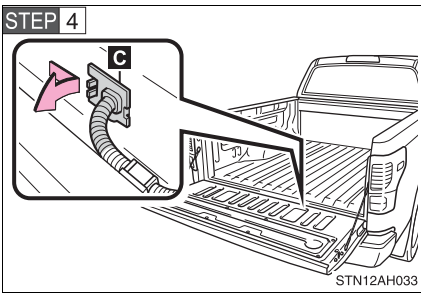

Pull out the plastic wire protector located in the vehicle bed by pressing the tabs and pulling the protector.

C Plastic wire protector

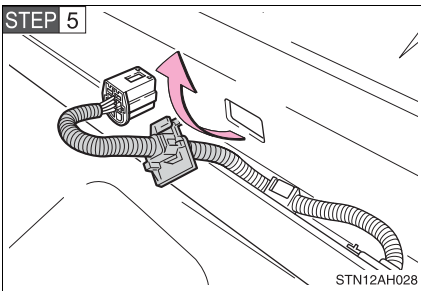

Pull out the wire harness from the vehicle bed.

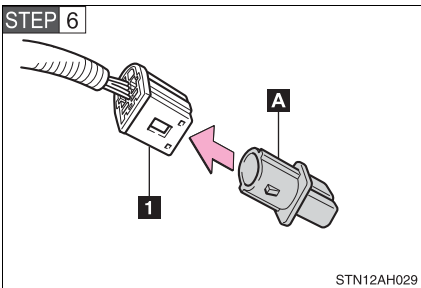

Attach the tailgate wire harness connector cover to the tailgate wire harness connector.

1 Tailgate wire harness connector

A Tailgate wire harness connector cover

■ **Before removing the tailgate (vehicles with rear view monitor system [Type B])**

These connector covers are used when removing the tailgate, to prevent the back-up camera wire harness connectors from being contaminated.

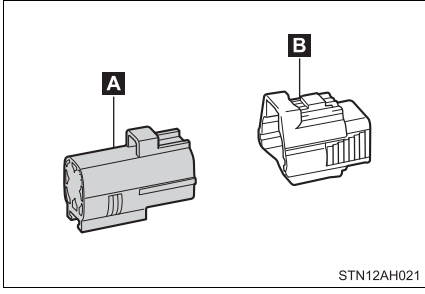

A Connector cover (Gray)

B Connector cover (White)

Store the connector covers in the glove box in a plastic bag when not using.

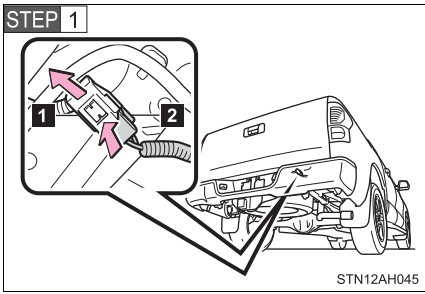

To disconnect the wire harness connectors (1 and 2), press and hold the lock of the tailgate wire harness connector (White) and pull apart.

1 Tailgate wire harness connector (White)

2 Frame wire harness connector (Gray)

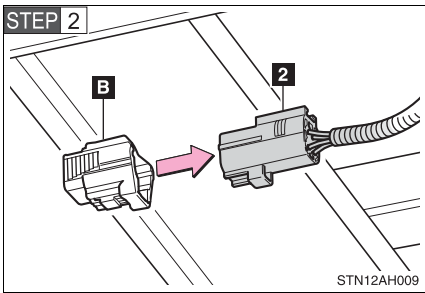

Attach the connector cover (White) to the frame wire harness connector (Gray).

B Connector cover (White)

2 Frame wire harness connector (Gray)

1-2. Opening, closing and locking the doors

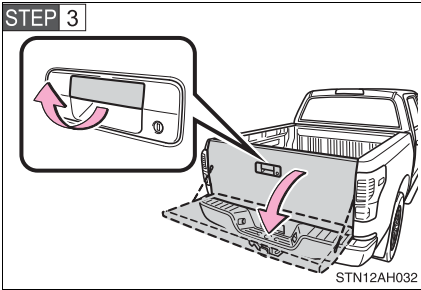

Open the tailgate.

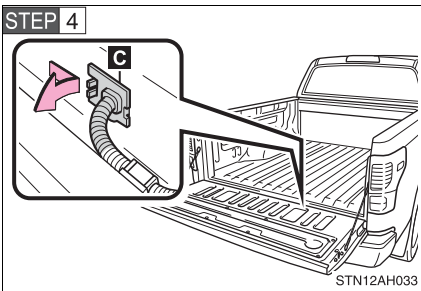

Pull out the plastic wire protector located in the vehicle bed by pressing the tabs and pulling the protector.

C Plastic wire protector

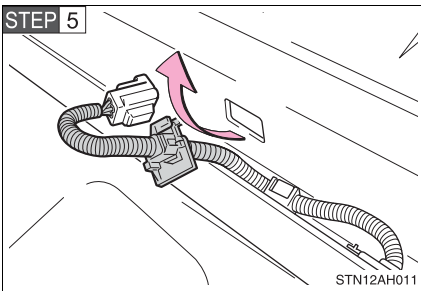

Pull out the wire harness from the vehicle bed.

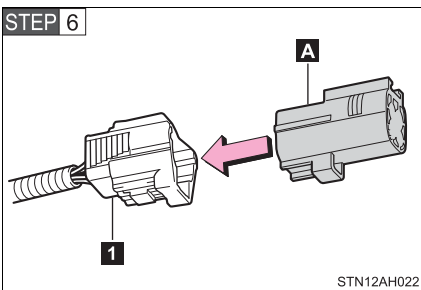

Attach the connector cover (Gray) to the tailgate wire harness connector (White).

1 Tailgate wire harness connector (White)

A Connector cover (Gray)

■ Removing the tailgate

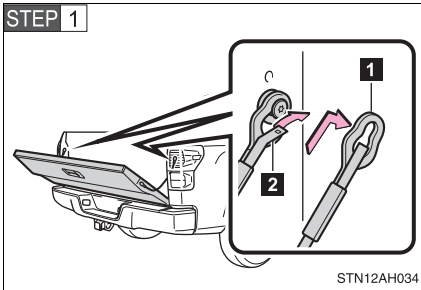

Open the tailgate to the angle where you can release the brackets on the support cables from the lugs on both sides. Lift the support cable bracket up and slide it off.

To unhook the support cable bracket, keep pulling up the clip on the bracket and unhook the bracket.

1 Support cable bracket

2 Clip

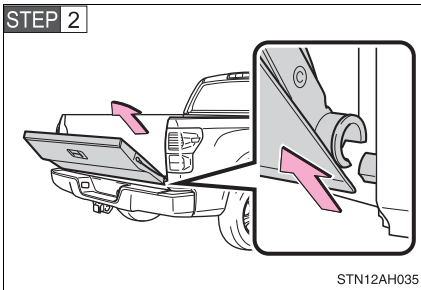

Tilt the tailgate to about 45° from vertical and pull up the right side of the tailgate to unhook the right side.

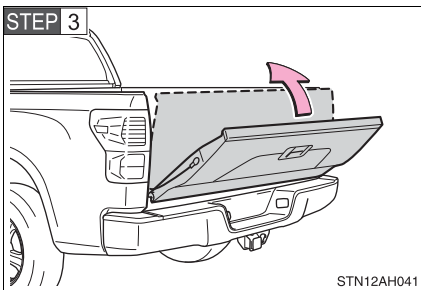

Tilt the tailgate up to 15°.

1-2. Opening, closing and locking the doors

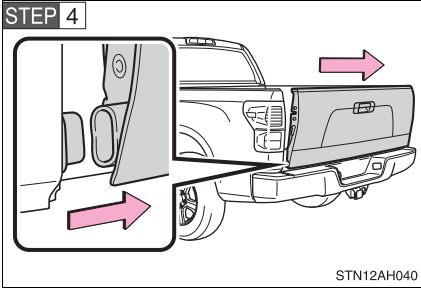

Slide the tailgate a little to the right to unhook the left side.

To attach the tailgate, follow the removal procedure in reverse order.

Rear step bumper

► Type A

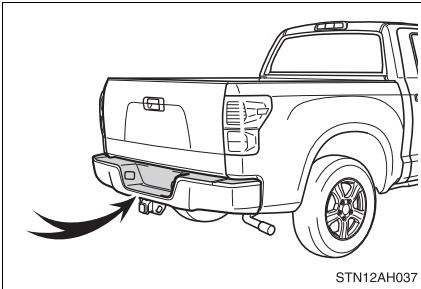

For rear end protection and easier step-up loading.

To get on the rear step bumper, use the shaded area in the illustration.

► Type B

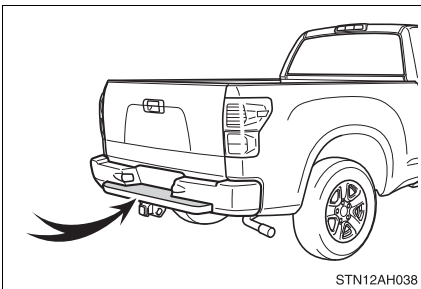

 CAUTION**■ Before removing the tailgate (vehicles with rear view monitor system)**

Disconnect the wire harness between the back-up camera and the vehicle. Failure to do so may result in serious personal injury or damage to the vehicle components.

■ Caution while driving

Observe the following precautions.

Failure to do so may result in death or serious personal injury.

- Do not drive with the tailgate open.
- Do not get on the rear step bumper.

 NOTICE**■ To prevent damage to the tailgate wire harness (vehicles with rear view monitor system)**

Do not pull out all of the tailgate wire harness before open the tailgate.

■ To prevent damage to the camera lens (vehicles with rear view monitor system)

Store the removed tailgate with the back-up camera lens facing upward.

■ After closing the tailgate

Try pulling it toward you to make sure it is securely locked.

■ To prevent damage to the rear step bumper

Do not allow more than one person to get on the rear step bumper at a time.

Front seats

► Manual seats (Separated type seats)

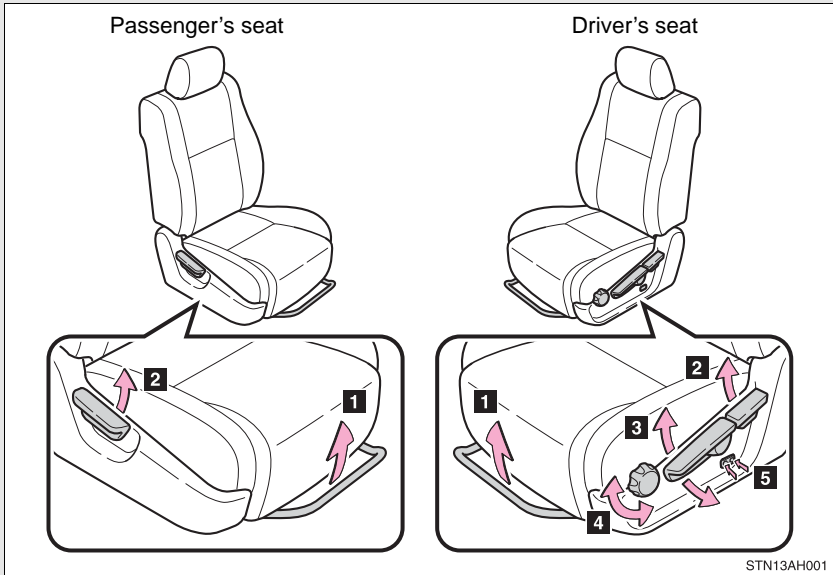

1 Seat position adjustment lever

2 Seatback angle adjustment lever

► Double Cab and CrewMax models

3 Driver's seat vertical height adjustment lever

4 Driver's seat cushion (front) angle adjustment knob

5 Driver's seat lumbar support adjustment switch (if equipped)

► Manual seat (Bench type seat)

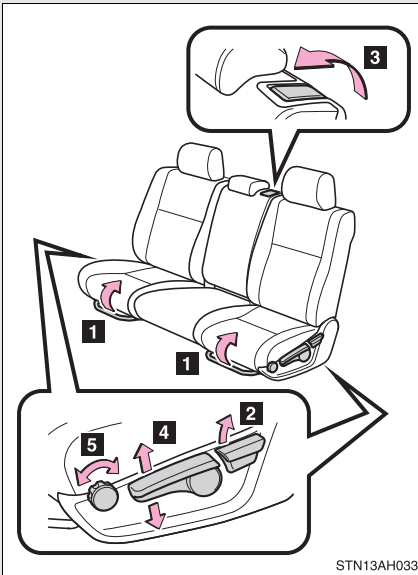

- 1** Seat position adjustment levers
- 2** Seatback angle adjustment levers
- 3** Center seat seatback angle adjustment lever
- Double Cab and CrewMax models
- 4** Driver's seat vertical height adjustment lever
- 5** Driver's seat cushion (front) angle adjustment knob

► Power seat

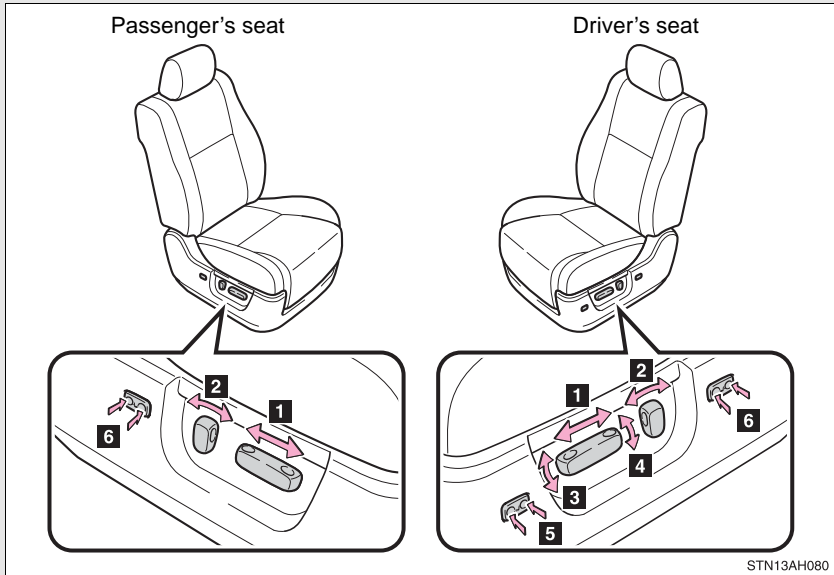

- 1** Seat position adjustment switch
- 2** Seatback angle adjustment switch
- 3** Driver's seat cushion (front) angle adjustment switch
- 4** Driver's seat vertical height adjustment switch
- 5** Driver's seat leg support adjustment switch (if equipped)
- 6** Seat lumbar support adjustment switch

Folding passenger's seat (if equipped on Regular Cab models)

■ Before folding passenger's seat

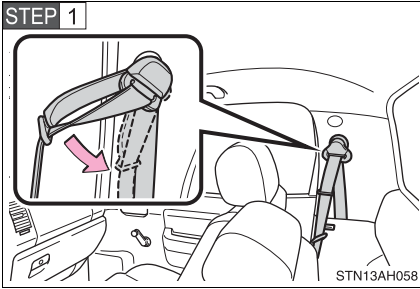

Push the seat belt hanger down as far as it will go when it is in the raised position.

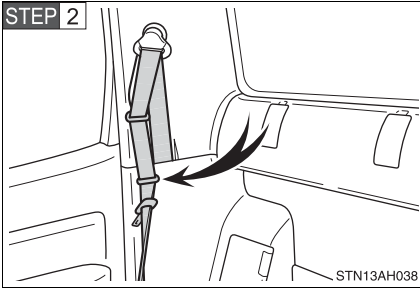

Pass the seat belts through the seat belt hanger.

This prevents the shoulder belt from being damaged.

Make sure that the seat belt is removed from the hanger before using it.

■ Folding passenger's seat

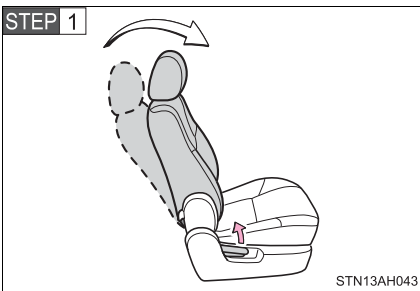

Pull the seatback angle adjusting lever and raise the seatback to its upright position.

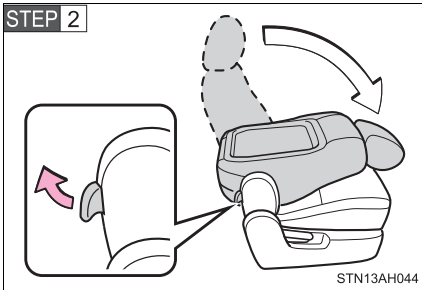

Pull the seatback folding lever and fold the seatback down.

⚠ CAUTION

■ Seat adjustment

- Be careful that the seat does not hit passengers or luggage.
- Do not recline the seat more than necessary when the vehicle is in motion to reduce the risk of sliding under the lap belt.
If the seat is too reclined, the lap belt may slide past the hips and apply restraint forces directly to the abdomen or your neck may contact the shoulder belt, increasing the risk of death or serious injury in the event of an accident.
- Manual seat only: After adjusting the seat, make sure that the seat is locked in position.

■ After returning the seatback to the upright position

Observe the following precautions. Failure to do so may result in death or serious injury.

- Make sure the seatback is securely locked.
- Check that the seat belts are not twisted or caught in the seatback.
- Arrange the seat belts in the proper positions for ready use.

■ Caution while driving

Vehicles with seatback table: Do not sit on or place anything on the folded seatback.

1-3. Adjustable components (seats, mirrors, steering wheel) Rear seats (Double Cab and CrewMax models)

► CrewMax models

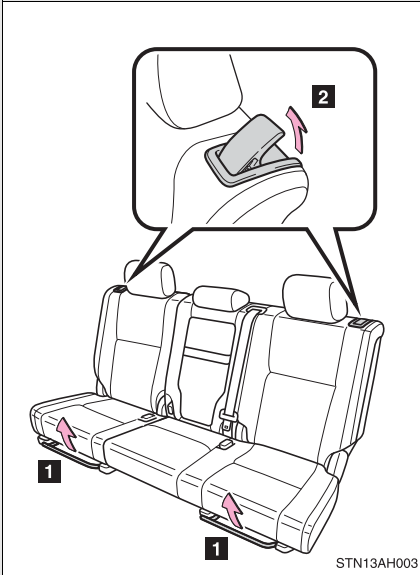

- 1** Seat position adjustment lever
- 2** Seatback angle adjustment lever

► Double Cab models

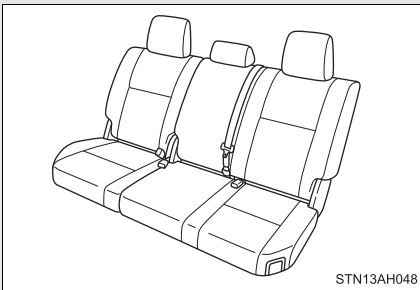

The rear seats do not have a seat adjustment function.

Raising the bottom cushion (Double Cab models)

■ Before raising the bottom cushion

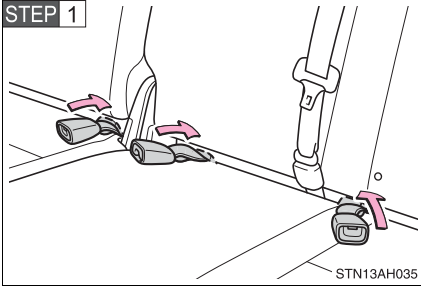

Stow the seat belt buckles.

This prevents the seat belt buckles from falling out when you fold the seatback.

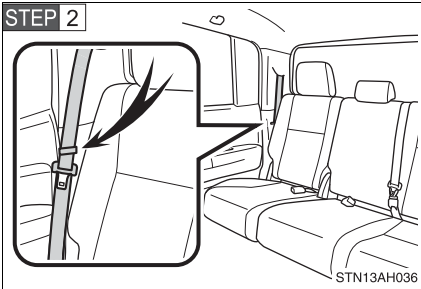

Pass the seat belts through the seat belt hangers.

This prevents the shoulder belt from being damaged.

Make sure that the seat belts are removed from the hangers before using them.

■ Raising the bottom cushion

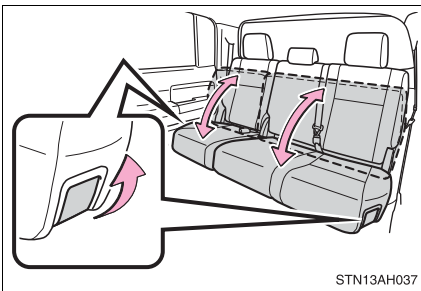

Raise the bottom cushion up while pulling the lever until it locks.

When returning bottom cushion to its original position, push the bottom cushion down while pulling the lever until it locks.

Folding down rear seats (CrewMax models)

■ Before folding down rear seats

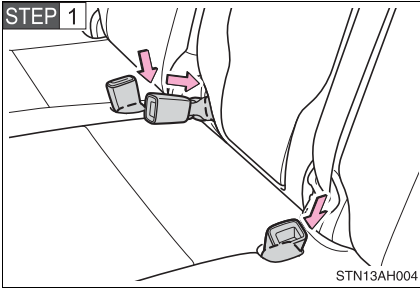

Stow the rear seat belt buckles.

This prevents the seat belt buckles from falling out when you fold the seatback.

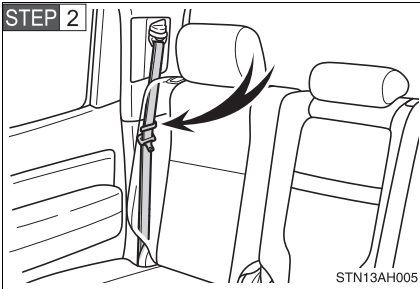

Pass the seat belts through the seat belt hangers.

This prevents the shoulder belt from being damaged.

Make sure that the seat belts are removed from the hangers before using them.

■ Folding down rear seats

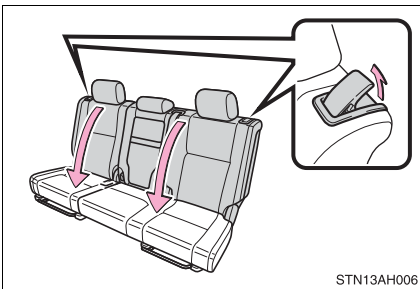

Pull the lever to unlock the seatback and fold the seatback down until it locks.

 CAUTION

■ **When adjusting a rear seat (CrewMax models)**

- Be careful that the seat does not hit passengers or luggage.
- Do not recline the seat more than necessary when the vehicle is in motion to reduce the risk of sliding under the lap belt. If the seat is too reclined, the lap belt may slide past the hips and apply restraint forces directly to the abdomen or your neck may contact the shoulder belt, increasing the risk of death or serious injury in the event of an accident.
- Be careful not to get your hands or feet caught in the seat.

■ **Before folding down a rear seat**

Do not fold down a rear seat when there are passengers sitting in the rear seats or when there is luggage placed on/under the rear seats.

■ **After adjusting a seat (CrewMax models)**

Observe the following precautions. Failure to do so may result in death or serious injury.

- Make sure that the seat and seatback are securely locked in position by lightly rocking them back and forth.
- Check that the seat belts are not twisted or caught in the seat.

■ **When the seatback is folded/the bottom cushion is raised (Double Cab models)**

Do not sit on or place anything on the seatback or storage box while driving.

■ **When returning the seats to their original position**

Observe the following precautions. Failure to do so may result in death or serious injury.

- Be careful not to get your hands or feet pinched in the seat.
- Make sure the seatbacks and bottom cushions are securely locked. Failure to do so will prevent the seat belt from operating properly.
- Check that the seat belts are not twisted or caught in the seat.
- Arrange the seat belts in the proper positions for ready use.



NOTICE

■ **When folding the seats**

- The seat belts and buckles must be stowed.
- CrewMax models: Do not fold the rear seat seatback forward with the luggage cover hooks attached.

1-3. Adjustable components (seats, mirrors, steering wheel) Driving position memory (driver's seat)*

Your preferred driving position (the position of the driver's seat, steering wheel and outside rear view mirrors) can be entered into the computer's memory and recalled with the touch of a button. Two different driving positions can be entered into memory.

■ Entering a position into memory

Check that the shift lever is set in P.

STEP 1 Turn the engine switch to the ON position.

STEP 2 Adjust the driver's seat, steering wheel, and outside rear view mirrors to the desired positions.

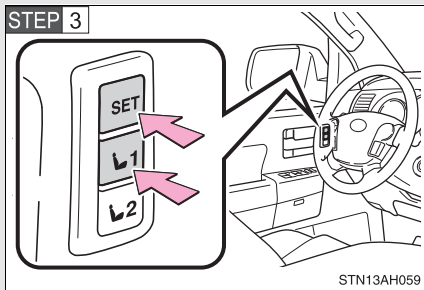

While pushing the SET button, push button "1" or "2" until the signal beeps.

If the selected button has already been preset, the previously recorded position will be overwritten.

■ Recalling the memorized position

Check that the shift lever is set in P.

STEP 1 Turn the engine switch to the ON position.

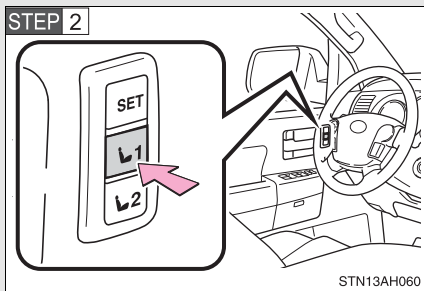

Push button "1" or "2" to recall the desired position.

*: If equipped

Linking driving position memory with door unlock operation

Memorized driving positions can be recalled when you unlock the driver's door using the wireless remote control and open the driver's door.

■ Setting the linked door unlock operation

STEP 1 Set the driving positions into the memory system using the "1" or "2" buttons. (→P. 70)

STEP 2 Turn the engine switch off then, close the driver's door.

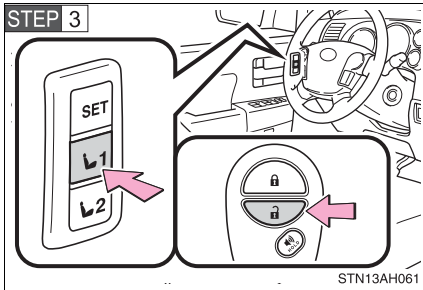

Push the "1" or "2" button and the  button on the wireless remote control at the same time for about 1 second until you hear a beep.

STEP 4 Open one of the doors.

If a door is not opened within 60 seconds after  is pressed, the doors will be locked again and the alarm will automatically be set. In case the alarm is triggered, immediately stop the alarm. (→P. 116)

■ Canceling the linked door unlock operation

STEP 1 Close the driver's door with the engine switch turned off.

STEP 2 Push the SET button and the  button on the wireless remote control at the same time for about 1 second until you hear 2 beeps.

■ **Retained accessory power**

Each memorized position (except for the tilt and telescopic steering column) can be activated within 30 seconds after the driver's door is opened, even if the key is not in the engine switch.

■ **If any position memory button is pushed while the adjustments are being made**

The operation will stop. To reactivate the system, push the button ("1" or "2") again.

■ **If the battery is disconnected**

The memorized positions must be reset because the computer's memory is erased when the battery is disconnected.

 **CAUTION**

■ **Seat adjustment caution**

Take care during seat adjustment that the seat does not strike the rear passenger or squeeze your body against the steering wheel.

If this happens, you can stop the movement by pressing another seat position memory button.

1-3. Adjustable components (seats, mirrors, steering wheel) Head restraints

Head restraints are provided for all seats.

► Front separated type seats

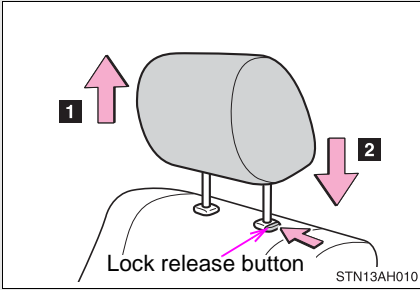

Vertical adjustment

1 Up

Pull the head restraints up.

2 Down

Push the head restraint down while pushing the lock release button.

► Front bench type seat

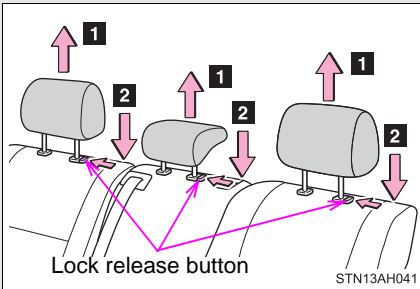

Vertical adjustment

1 Up

Pull the head restraints up.

2 Down

Push the head restraint down while pushing the lock release button.

► Rear seat (Double Cab models)

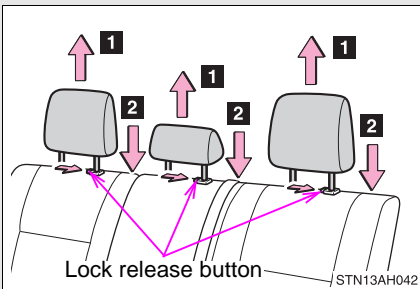

Vertical adjustment

1 Up

Pull the head restraints up.

2 Down

Push the head restraint down while pushing the lock release button.

► Rear seat (CrewMax models)

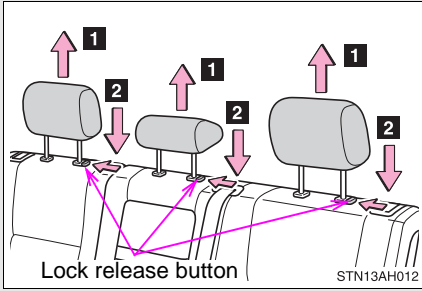

Vertical adjustment

1 Up

Pull the head restraints up.

2 Down

Push the head restraint down while pushing the lock release button.

■ Removing the front head restraints

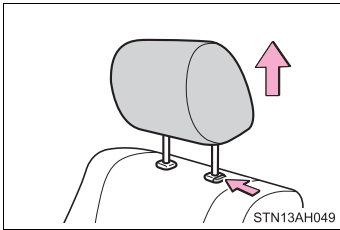

Pull the head restraint up while pushing the lock release button.

■ Removing the rear head restraints

► Double Cab models

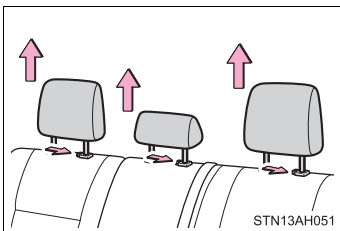

Pull the head restraint up while pushing the lock release button.

► CrewMax models

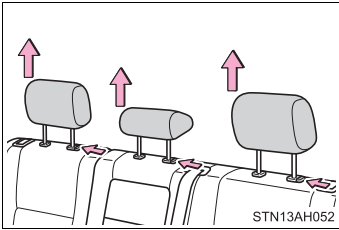

Pull the head restraint up while pushing the lock release button.

■ Installing the front head restraints

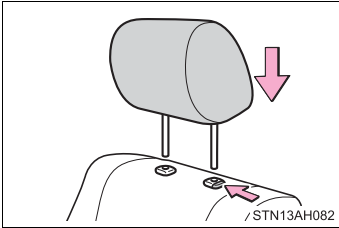

Align the head restraint with the installation holes and push it down to the lock position.

Press and hold the lock release button when lowering the head restraint.

■ Installing the rear head restraints

► Double Cab models

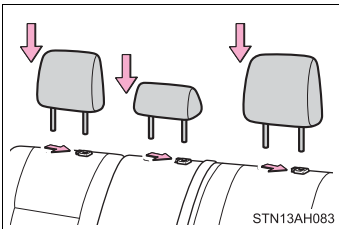

Align the head restraint with the installation holes and push it down to the lock position.

Press and hold the lock release button when lowering the head restraint.

► CrewMax models

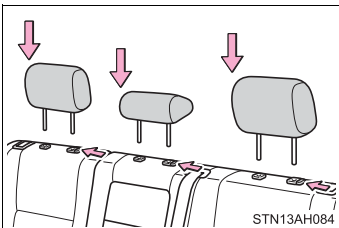

Align the head restraint with the installation holes and push it down to the lock position.

Press and hold the lock release button when lowering the head restraint.

■ Adjusting the height of the head restraints

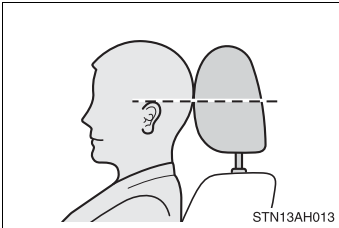

Make sure that the head restraints are adjusted so that the center of the head restraint is closest to the top of your ears.

■ Adjusting the front center seat (bench type seat) and rear center seat head restraints (Double Cab and CrewMax models)

Always raise the head restraint one level from the stowed position when using.

⚠ CAUTION

■ Head restraint precautions

Observe the following precautions regarding the head restraints. Failure to do so may result in death or serious injury.

- Use the head restraints designed for each respective seat.
- Adjust the head restraints to the correct position at all times.
- After adjusting the head restraints, push down on them and make sure they are locked in position.
- Do not drive with the head restraints removed.

Make sure that all occupants are wearing their seat belts before driving the vehicle.

■ **Correct use of the seat belts**



- Extend the shoulder belt so that it comes fully over the shoulder, but does not come into contact with the neck or slide off the shoulder.
- Position the lap belt as low as possible over the hips.
- Adjust the position of the seatback. Sit up straight and well back in the seat.
- Do not twist the seat belt.

■ **Fastening and releasing the seat belt**

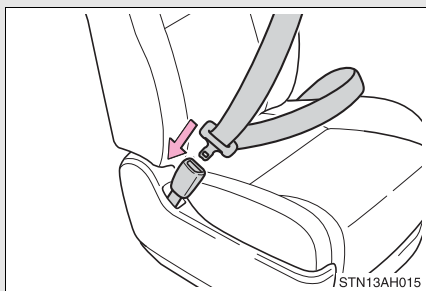

Fastening the belt

Push the tab into the buckle until a clicking sound is heard.

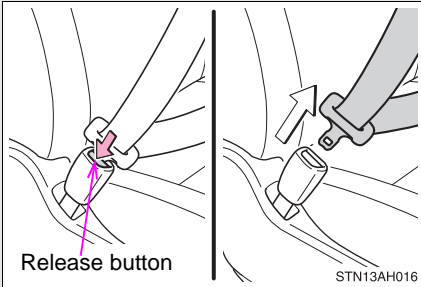

Releasing the belt

Press the release button.

■ Using front seat belt (Regular Cab models)

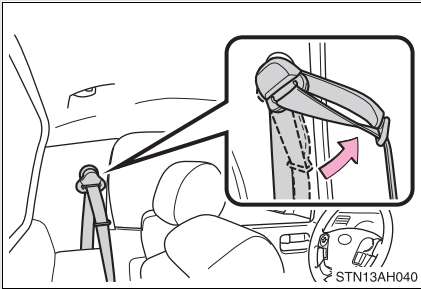

Raise the front seat belt hanger until it locks.

■ Adjusting the height of the belt

► Front seats (Double Cab and CrewMax models)

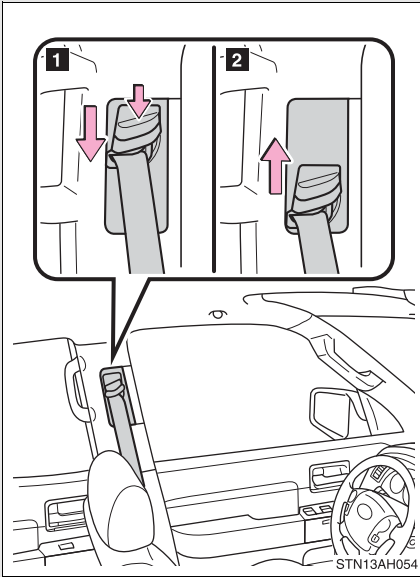

1 Down

Push the lock release button and slide the height adjuster down.

2 Up

Move the height adjuster up as needed until you hear a click.

► Rear seats (CrewMax models)

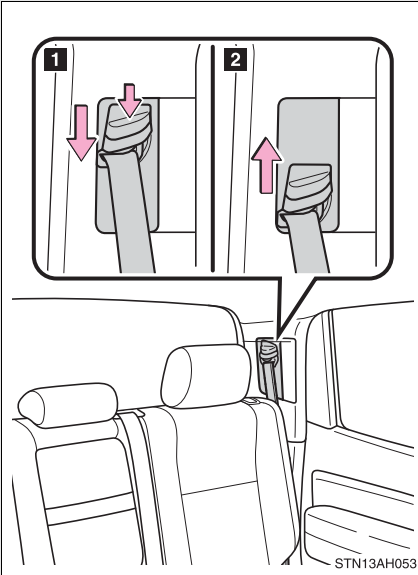

1 Down

Push the lock release button and slide the height adjuster down.

2 Up

Move the height adjuster up as needed until you hear a click.

Seat belt pretensioners (front seats)

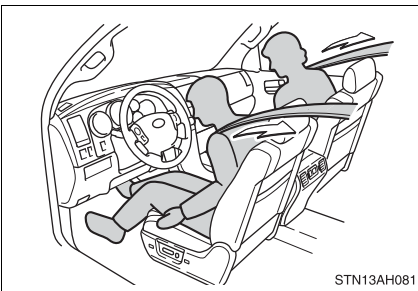

The pretensioner helps the seat belt to quickly restrain the occupant by retracting the seat belt when the vehicle is subjected to certain types of severe frontal collision or a vehicle rollover.

The pretensioner may not activate in the event of a minor frontal impact, a side impact or a rear impact.

■ Emergency locking retractor (ELR)

The retractor will lock the belt during a sudden stop or on impact. It may also lock if you lean forward too quickly. A slow, easy motion will allow the belt to extend so that you can move around fully.

■ Automatic locking retractor (ALR)

When a passenger's shoulder belt is completely extended and then retracted even slightly, the belt is locked in that position and cannot be extended. This feature is used to hold the child restraint system (CRS) firmly. To free the belt again, fully retract the belt and then pull the belt out once more. (→P. 149)

■ Pregnant women

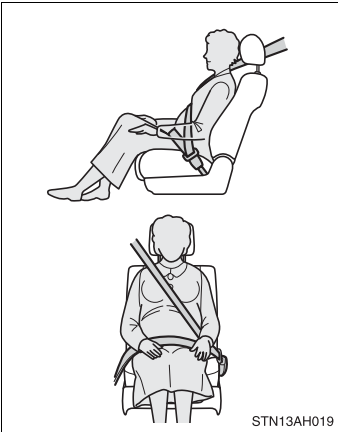

Obtain medical advice and wear the seat belt in the proper way. (→P. 77)

Women who are pregnant should position the lap belt as low as possible over the hips in the same manner as other occupants. Extend the shoulder belt completely over the shoulder and position the belt across the chest. Avoid belt contact over the rounding of the abdominal area.

If the seat belt is not worn properly, not only a pregnant woman, but also the fetus could suffer death or serious injury as a result of sudden braking or a collision.

■ People suffering illness

Obtain medical advice and wear the seat belt in the proper way.

■ Child seat belt usage

The seat belts of your vehicle were principally designed for persons of adult size.

- Use a child restraint system appropriate for the child, until the child become large enough to properly wear the vehicle's seat belt. (→P. 143)
- When the child becomes large enough to properly wear the vehicle's seat belt, follow the instructions on P. 77 regarding seat belt usage.

■ Replacing the belt after the pretensioner has been activated

If the vehicle is involved in multiple collisions, the pretensioner will activate for the first collision, but will not activate for the second or subsequent collisions.

■ Seat belt extender

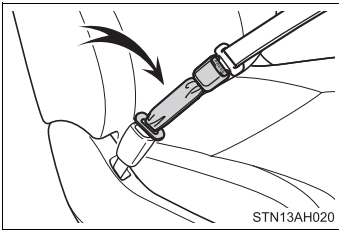

If your seat belts cannot be fastened securely because they are not long enough, a personalized seat belt extender is available from your Toyota dealer free of charge.

⚠ CAUTION

Observe the following precautions to reduce the risk of injury in the event of sudden braking, sudden swerving or an accident. Failing to do so may cause death or severe injury.

■ Wearing a seat belt

- Ensure that all passengers wear a seat belt.
- Always wear a seat belt properly.
- Each seat belt should be used by one person only. Do not use a seat belt for more than one person at once, including children.
- Toyota recommends that children be seated in the rear seat and always use a seat belt and/or an appropriate child restraint system.

⚠ CAUTION**■ Wearing a seat belt**

- Do not recline the seat any more than necessary to achieve a proper seating position. The seat belt is most effective when the occupants are sitting up straight and well back in the seats.
- Do not wear the shoulder belt under your arm.
- Always wear your seat belt low and snug across your hips.

■ Adjustable shoulder anchor

Always make sure the shoulder belt is positioned across the center of your shoulder. The belt should be kept away from your neck, but not falling off your shoulder. Failure to do so could reduce the amount of protection in an accident and cause death or serious injuries in the event of a sudden stop, sudden swerve or accident. (→P. 79)

■ Seat belt pretensioners

- Do not place anything, such as a cushion, on the front passenger's seat. Doing so will disperse the passenger's weight, which prevents the sensor from detecting the passenger's weight properly. As a result, the seat belt pretensioner for the front passenger's seat may not activate in the event of a collision.
- If the pretensioner has activated, the SRS warning light will come on. In that case, the seat belt cannot be used again and must be replaced at your Toyota dealer.

■ Child restraint lock function belt precaution

Do not allow children to play with the child restraint lock function belt. If the belt becomes twisted around a child's neck, it will not be possible to pull the belt out leading to choking or other serious injuries that could result in death. If this occurs and the buckle cannot be unfastened, scissors should be used to cut the belt.

■ Seat belt damage and wear

- Do not damage the seat belts by allowing the belt, plate, or buckle to be jammed in the door.
- Inspect the seat belt system periodically. Check for cuts, fraying, and loose parts. Do not use a damaged seat belt until it is replaced. Damaged seat belt cannot protect an occupant from death or serious injury.

 CAUTION

■ **Seat belt damage and wear**

- Ensure that the belt and tab are locked and the belt is not twisted.
If the seat belt does not function correctly, immediately contact your Toyota dealer.
- Replace the seat assembly, including the belts, if your vehicle has been involved in a serious accident, even if there is no obvious damage.
- Do not attempt to install, remove, modify, disassemble or dispose of the seat belts. Have any necessary repairs carried out by your Toyota dealer. Inappropriate handling of the pretensioner may prevent it from operating properly resulting in death or serious injury.

■ **Before using a front seat belt (Regular Cab models)**

Make sure the seat belt hanger is secured in the raised position before you fasten the seat belt.

■ **Using a seat belt extender**

- Do not wear the seat belt extender if you can fasten the seat belt without the extender.
- Do not use the seat belt extender when installing a child restraint system because the belt will not securely hold the child restraint system, increasing the risk of death or serious injury in the event of an accident.
- The personalized extender may not be safe on another vehicle, when used by another person, or at a different seating position other than the one originally intended.

 NOTICE

■ **When using a seat belt extender**

When releasing the seat belt, press on the buckle release button on the extender, not on the seat belt.

This helps prevent damage to the vehicle interior and the extender itself.

1-3. Adjustable components (seats, mirrors, steering wheel) Steering wheel (manually adjustable type)

The steering wheel can be adjusted to a comfortable position.

■ To change the angle

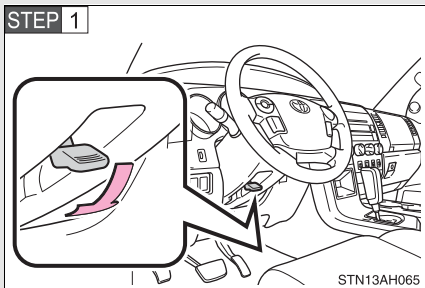

Hold the steering wheel and press the lever down.

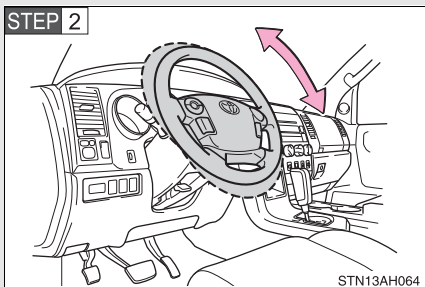

Adjust to the ideal position by moving the steering wheel vertically.

After adjustment, pull the lever up to secure the steering wheel.

■ To change the column length (vehicles with separate type seats)

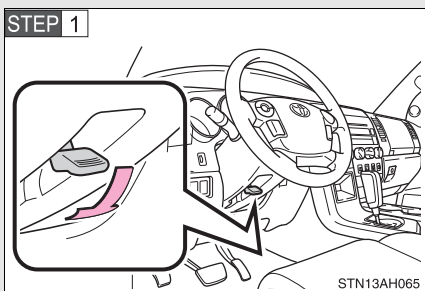

Hold the steering wheel and press the lever down.

STEP 2

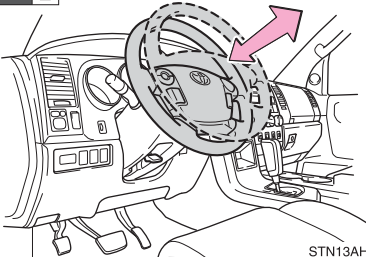

Adjust to the ideal position by moving the steering wheel horizontally.

After adjustment, pull the lever up to secure the steering wheel.

⚠ CAUTION

■ Caution while driving

Do not adjust the steering wheel while driving.

Doing so may cause the driver to mishandle the vehicle and an accident, resulting in death or serious injury.

■ After adjusting the steering wheel

Make sure that the steering wheel is securely locked.

Otherwise, the steering wheel may move suddenly, possibly causing an accident and resulting in death or serious injury.

1-3. Adjustable components (seats, mirrors, steering wheel)

Steering wheel (power-adjustable type)

The steering wheel can be adjusted to a comfortable position.

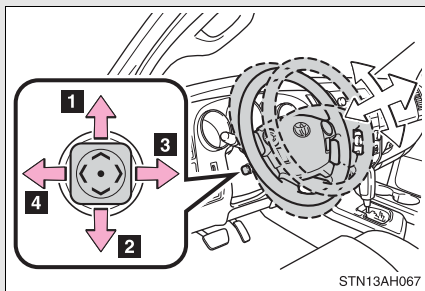

- 1 Up
- 2 Down
- 3 Toward the driver
- 4 Away from the driver

Auto tilt away

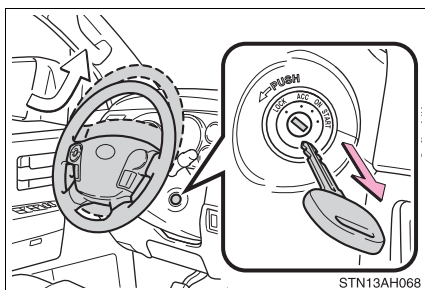

When the key is removed from the engine switch, the steering wheel returns to its stowed position by moving up and away to enable easier driver entry and exit.

Inserting the key into the engine switch returns the steering wheel to its original position.

⚠ CAUTION

■ Caution while driving

Do not adjust the steering wheel while driving.

Doing so may cause the driver to mishandle the vehicle and an accident, resulting in death or serious injury.

1-3. Adjustable components (seats, mirrors, steering wheel) Anti-glare inside rear view mirror

Glare from the headlights of vehicles behind can be reduced by using the following functions.

► Manual anti-glare inside rear view mirror

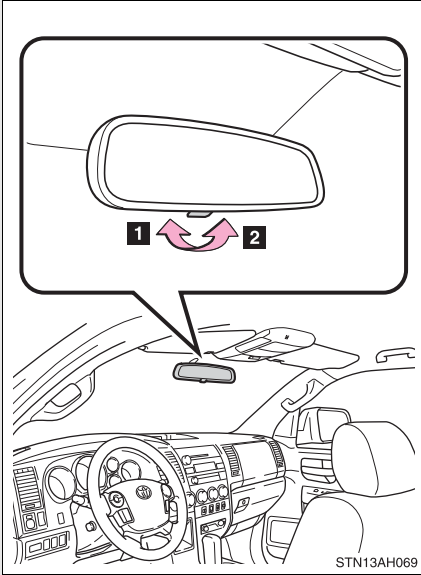

- 1 Normal position
- 2 Anti-glare position

► Auto anti-glare inside rear view mirror

In automatic mode, sensors are used to detect the headlights of vehicles behind and automatically reduces the reflected light.

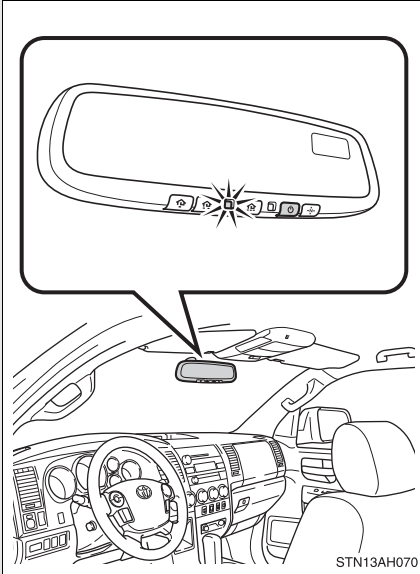

Turns automatic mode ON/OFF

The indicator comes on when automatic mode is turned on.

The mirror will revert to the automatic mode each time the engine switch is turned on.

■ To prevent sensor error (vehicles with auto anti-glare inside rear view mirror)

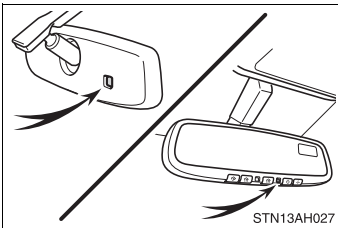

To ensure that the sensors operate properly, do not touch or cover them.

■ If a sun visor interferes with the mirror

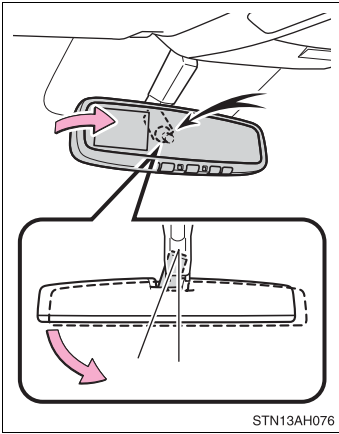

Hold and rotate the mirror to adjust the support.

⚠ CAUTION

■ **Caution while driving**

Do not adjust the position of the mirror while driving.

Doing so may lead to mishandling of the vehicle and an accident, resulting in death or serious injury.

1-3. Adjustable components (seats, mirrors, steering wheel)

Outside rear view mirrors

Mirror angle can be adjusted.

► Power-adjustable type (Type A)

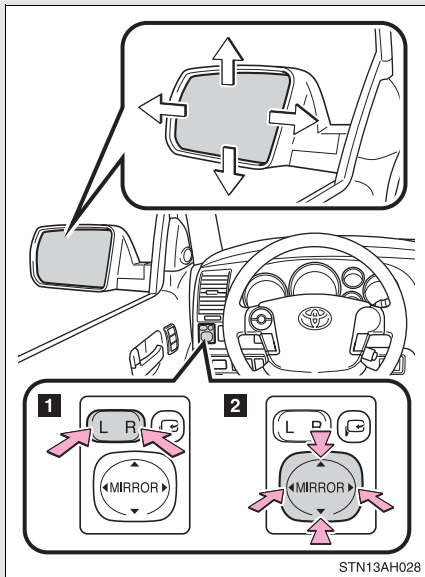

- 1 Select a mirror to adjust.
(L: left or R: right)
- 2 Adjust the mirror up, down, in or out using the switch.

► Power-adjustable type (Type B)

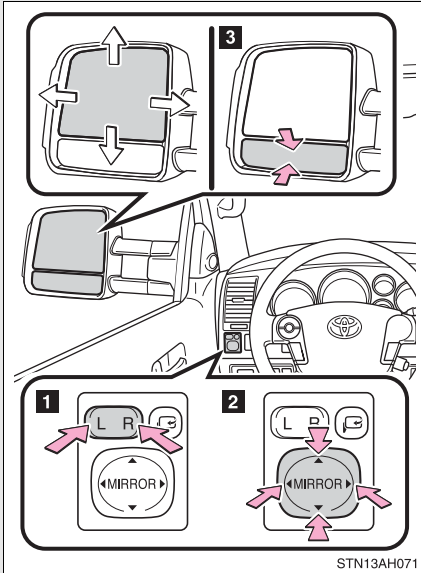

Upper part mirror:

- 1 Select a mirror to adjust.
(L: left or R: right)
- 2 Adjust the mirror up, down, in or out using the switch.

Lower part mirror:

- 3 Adjust the mirror up and down, in or out by pushing the mirror surface.

► Manually adjustable type

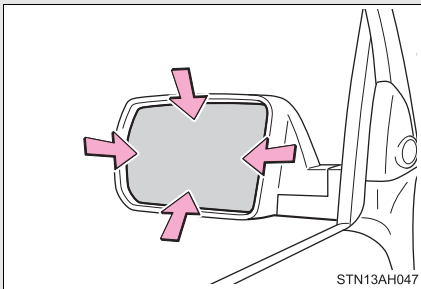

Adjust the mirror up, down, in or out by pushing the mirror surface.

Folding back the mirrors

► From outside

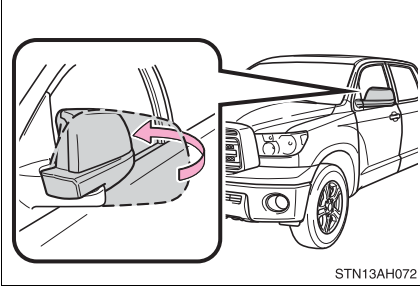

Push backward to fold the mirrors.

► From inside (if equipped)



Press the switch.

Pressing again will unfold the mirrors.

Extending the mirrors (if equipped)

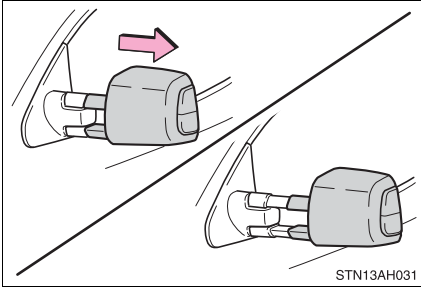

The mirrors can be manually slid outward to improve visibility around wide trailers.

Recommended mirror angle when towing a trailer (vehicles with extending mirrors)

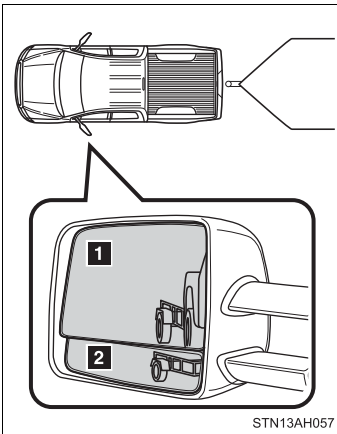

1 Power adjust the upper part of the mirror until an appropriate view is obtained. It is recommended that the outer 2/3 of the upper mirror be filled with images other than the vehicle and trailer.

2 Manually adjust the lower part of the mirror until an appropriate view of the towed object is obtained. It is recommended that the outer 2/3 of the lower mirror be filled with images other than the trailer.

Mirror operating conditions (if equipped)

The engine switch is in the ACC or ON position.

When the mirrors are fogged up (vehicles with outside rear view mirror defoggers)

Turn on the mirror defoggers to defog the mirrors. (→P. 305, 307)

■ Automatic adjustment of the mirror angle (vehicles with driving position memory)

A desired mirror face angle can be entered to memory and recalled automatically by the driving position memory. (→P. 70)

■ Auto anti-glare function (if equipped)

When the anti-glare inside rear view mirror is set to automatic mode, the outside rear view mirrors will activate in conjunction with the anti-glare inside rear view mirror to reduce reflected light. (→P. 88)

CAUTION

■ When driving the vehicle

Observe the following precautions while driving.

Failing to do so may result in loss of control of the vehicle and cause an accident, resulting in death or serious injury.

- Do not adjust the mirrors while driving.
- Do not drive with the mirrors folded back.
- Both the driver and passenger side mirrors must be extended and properly adjusted before driving.

■ When a mirror is moving

To avoid personal injury and mirror malfunction, be careful not to get your hand caught by the moving mirror.

■ When the mirror defoggers are operating (vehicles with outside rear view mirror defoggers)

Do not touch the rear view mirror surfaces, as they can become very hot and burn you.

NOTICE

■ If ice should jam the mirror

Do not operate the control or scrape the mirror face. Use a spray de-icer to free the mirror.

1-4. Opening and closing the windows and moon roof Power windows*

The power windows can be opened and closed using the following switches.

► Driver's power window switches (Type A)

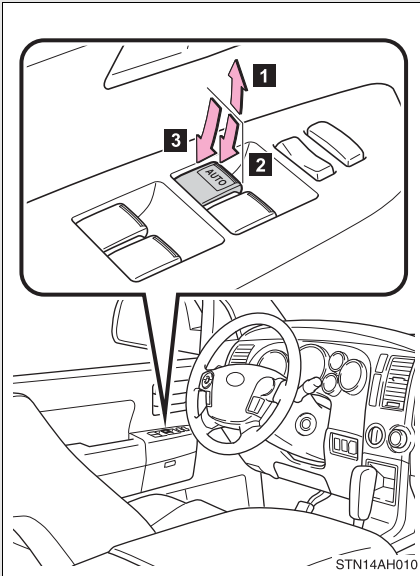

1 Closing

2 Opening

3 One-touch opening*
(driver's window only)

*: Pressing the switch in the opposite direction will stop window travel partway.

*: If equipped

▶ Driver's power window switches (Type B)

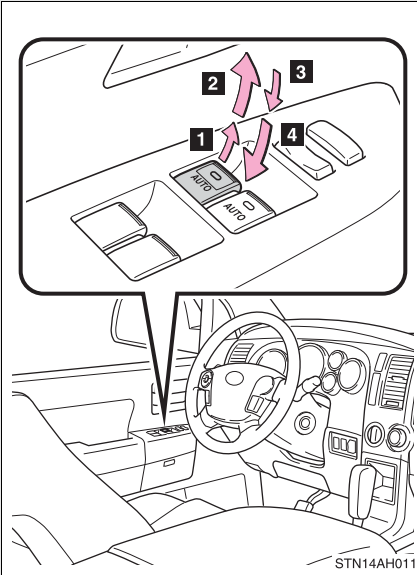

- 1** Closing
- 2** One-touch closing*
- 3** Opening
- 4** One-touch opening*

*: Pressing the switch in the opposite direction will stop window travel partway.

▶ Front passenger power's window switch (Type A)

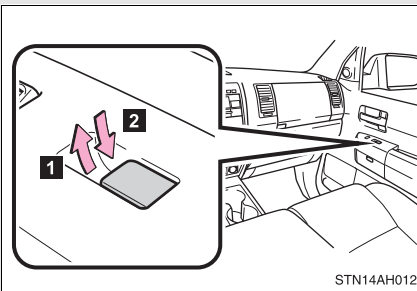

- 1** Closing
- 2** Opening

► Front passenger's power window switch (Type B)

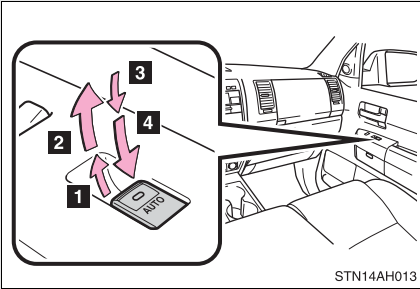

- 1 Closing
- 2 One-touch closing*
- 3 Opening
- 4 One-touch opening*

*: Pressing the switch in the opposite direction will stop window travel partway.

► Rear passenger's power window switch (Double Cab and Crew-Max models)

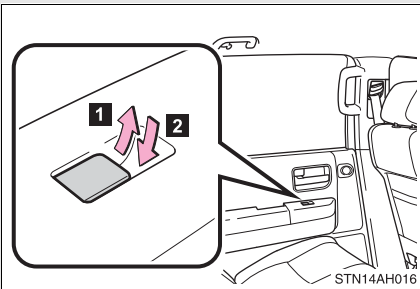

- 1 Closing
- 2 Opening

Lock switch

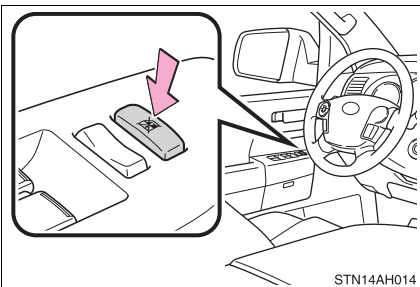

Press the switch down to lock passenger window switches.

Use this switch to prevent children from accidentally opening or closing a passenger window.

■ **The power windows can be operated when**

The engine switch is in the ON position.

■ **Operating the power windows after turning the engine switch off**

The power windows can be operated for approximately 43 seconds even after the engine switch is turned to the ACC position or turned off. They cannot, however, be operated once either front door is opened.

■ **Jam protection function (Type B only)**

If an object becomes caught between the window and the window frame, window travel is stopped and the window is opened slightly.

 **CAUTION**

■ **Closing the windows**

Observe the following precautions.

Failing to do so may result in death or serious injury.

● Check to make sure that all passengers do not have any part of their body in a position where it could be caught when a window is being operated.

● Do not allow children to operate the power windows.

Closing a power window on someone can cause serious injury, and in some instances, even death.

■ **Jam protection function (Type B only)**

● Never try jamming any part of your body to activate the jam protection function intentionally.

● The jam protection function may not work if something gets caught just before the window fully closes.

1-4. Opening and closing the windows and moon roof Back window*

The back window can be opened and closed using the lock release lever.

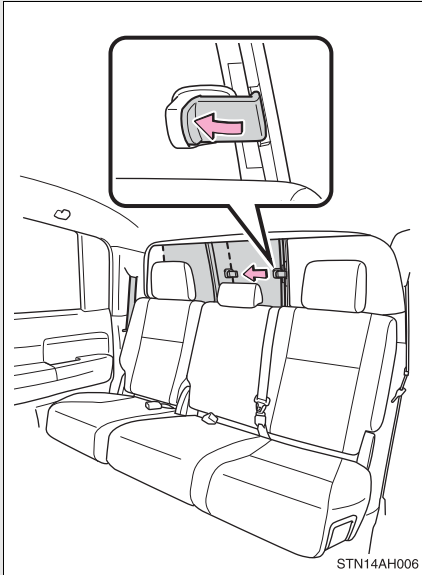

OPEN/CLOSE

Push the lock release lever and slide the back window.

■ Closing the back window

Make sure that the back window is securely closed after closing it.

⚠ CAUTION

■ Caution while driving

Keep the back window closed.

This not only keeps personal belongings from being thrown out, but also prevents exhaust gases from entering the vehicle.

*: If equipped

1-4. Opening and closing the windows and moon roof Power back window*

The back window can be opened and closed using the switch.

► Double Cab models

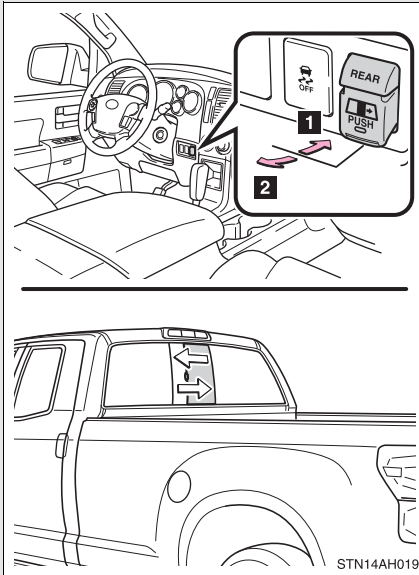

- 1 Opening
- 2 Closing

*: If equipped

► CrewMax models



1 Opening

2 Closing

■ **The power back window can be operated when**

The engine switch is in the ON position.

■ **Operating the power back windows after turning the engine switch off**

The power back windows can be operated for approximately 43 seconds even after the engine switch is turned to the ACC position or turned off. They cannot, however, be operated once either front door is opened.

 CAUTION

■ **Closing the back window**

Observe the following precautions.

Failing to do so may result in death or serious injury.

- Check to make sure that all passengers do not have any part of their body in a position where it could be caught when a window is being operated.
- Do not allow children to operate the power back window.
Closing a back window on someone can cause serious injury, and in some instances, even death.

■ **Caution while driving**

Keep the back window closed.

This not only keeps personal belongings from being thrown out, but also prevents exhaust gases from entering the vehicle.

1-4. Opening and closing the windows and moon roof Moon roof*

Use the overhead switches to open, close, and tilt the moon roof up and down.

■ Opening and closing

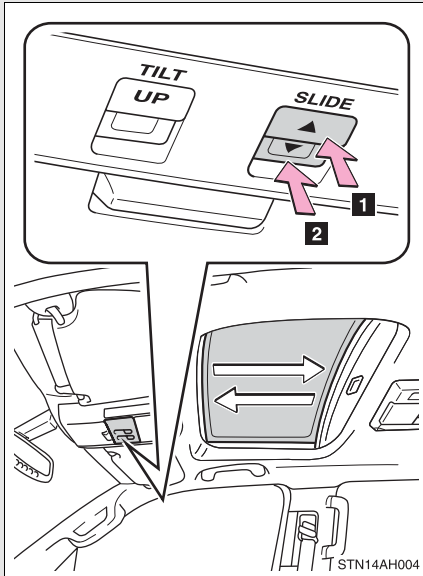

1 Open

2 Close

To stop partway, press the switch lightly.

*: If equipped

■ Tilt up and down

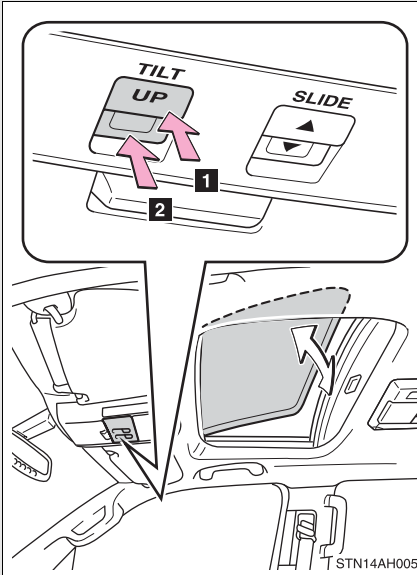

1 Tilt up

2 Tilt down

To stop partway, press the switch lightly.

■ The moon roof can be operated when

The engine switch is in the ON position.

■ Door lock linked moon roof operation

The moon roof can be opened and closed using the key. (→P. 47)

■ Operating the moon roof after turning the engine switch off

The moon roof can be operated for approximately 43 seconds even after the engine switch is turned to the ACC or turned off. It cannot, however, be operated once either front door is opened.

■ Jam protection function

If an object is detected between the moon roof and the frame while closing or tilting down, travel is stopped and the moon roof opens slightly.

■ **If the moon roof cannot be closed automatically**

Keep the switch depressed.

■ **Sunshade**

The sunshade can be opened and closed manually. However, the sunshade will open automatically when the moon roof is opened.

■ **Moon roof open reminder function**

An alarm will sound when the driver's door is opened with the moon roof not fully closed and the engine switch off.

■ **When the battery is disconnected**

The moon roof must be initialized in order to ensure proper operation.

STEP 1 Push and hold the switch toward the UP (tilt up) side or ▼ (sliding close) side.

STEP 2 After the moon roof will tilt up and down, release the switch.

STEP 3 To ensure the initialization is complete, make sure automatic opening and closing functions work properly.

■ When the moon roof does not close normally

Perform the following procedure:

- If the moon roof closes but then re-opens slightly.

STEP 1 Stop the vehicle.

STEP 2 Press and hold the ▼ (sliding close) switch.*¹

The moon roof will close, reopen and pause for approximately 10 seconds.*² Then it will close again, tilt up and pause for approximately 1 second. Finally, it will tilt down, open and close.

STEP 3 Check to make sure that the moon roof is completely closed and then release the switch.

- If the moon roof tilts down but then tilts back up

STEP 1 Stop the vehicle.

STEP 2 Press and hold the UP (tilt up) switch*¹ until the moon roof moves into the tilt up position and stops.

STEP 3 Release the UP (tilt up) switch once and then press and hold the UP (tilt up) switch again.*¹

The moon roof will pause for approximately 10 seconds in the tilt up position.*² Then it will adjust slightly and pause for approximately 1 second. Finally, it will tilt down, open and close.

STEP 4 Check to make sure that the moon roof is completely closed and then release the switch.

*¹: If the switch is released at the incorrect time, the procedure will have to be performed again from the beginning.

*²: If the switch is released after the above mentioned 10 second pause, automatic operation will be disabled. In that case, press and hold the ▼ (sliding close) or UP (tilt up) switch, and the moon roof will tilt up and pause for approximately 1 second. Then it will tilt down, open and close. Check to make sure that the moon roof is completely closed and then release the switch.

If the moon roof does not fully close even after performing the above procedure correctly, have the vehicle inspected by your Toyota dealer.

■ Customization that can be configured at Toyota dealer

Settings (e.g. moon roof) can be changed.

(Customizable features →P. 684)

 **CAUTION**

■ **Opening the moon roof**

Observe the following precautions.

Failing to do so may cause death or serious injury.

- Do not allow any passengers to put their hands or heads outside the vehicle while it is moving.
- Do not sit on top of the moon roof.

■ **Closing the moon roof**

Observe the following precautions.

Failing to do so may result in death or serious injury.

- Check to make sure that all passengers do not have any part of their bodies in a position where they could be caught when the moon roof is being operated.
- Do not allow children to operate the moon roof.
Closing the moon roof on someone can cause death or serious injury.

■ **Jam protection function**

- Never try jamming any part of your body to activate the jam protection function intentionally.
- The jam protection function may not work if something gets caught just before the moon roof fully closes.

Opening the fuel tank cap

Perform the following steps to open the fuel tank cap.

■ **Before refueling the vehicle**

Turn the engine switch off and ensure that all the doors and windows are closed.

■ **Opening the fuel tank cap**

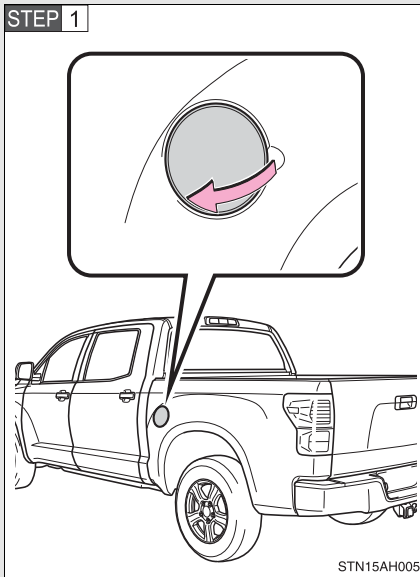

Open the fuel filler door.

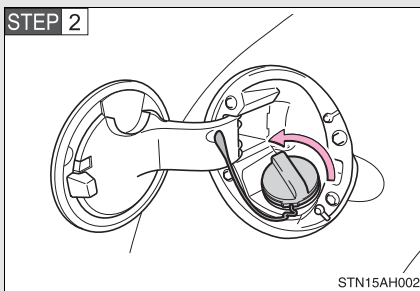

Turn the fuel tank cap slowly to open.

STEP 3

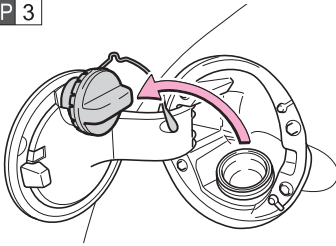

STN15AH003

Hang the fuel tank cap on the back of the fuel filler door.

Closing the fuel tank cap

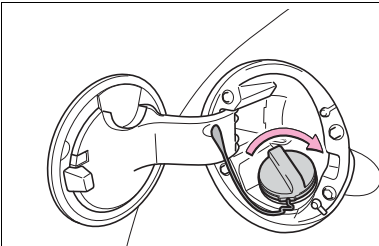

STN15AH004

When installing the fuel tank cap, turn it until you hear a click.

The cap will turn slightly to the opposite direction when released.

■ **Fuel types (Gasoline engine)**

Use unleaded gasoline. (Octane rating 87 [Research Octane Number 91] or higher)

■ **Fuel types (Flex-fuel engine)**

Use unleaded gasoline (Octane rating 87 [Research Octane Number 91] or higher), E85, or a blend of these two fuels. (→P. 669)

■ Identifying flex-fuel vehicles

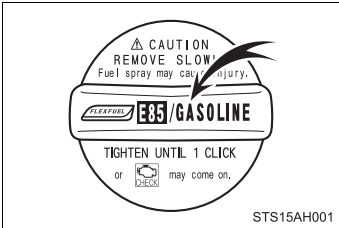

- Flex-fuel vehicles can be identified by the fuel tank cap, which is marked “FLEXFUEL E85/GASOLINE”.

■ Fuel tank capacity

Approximately 26.4 gal. (100 L, 22.0 Imp. gal.)

■ E85 Fueling Stations (Flex-fuel vehicles)

E85 fueling stations and fuel pumps can be identified by the indication “E85 85% Ethanol”. For more information about fueling stations, please refer to the U.S. Department of Energy Web site.

<http://www.eere.energy.gov/afdc/infrastructure/locator.html>

■ Refueling (Flex-fuel vehicles)

Observe the following precautions when switching fuels, in order to maintain starting and driving performance.

- Do not change fuels when the fuel level is 1/4 or less.
- Always add at least 2.6 gal. (10 L) of fuel.
- After filling up with fuel, warm up the engine or drive the vehicle for at least 5 minutes or 7 miles (11 km).
- Do not accelerate rapidly immediately after refueling.

 CAUTION

■ **Refueling the vehicle**

Observe the following precautions while refueling the vehicle.
Failure to do so may result in death or serious injury.

- Touch the vehicle or some other metal surface to discharge any static electricity.
Sparks resulting from discharging static electricity may cause the fuel vapors to ignite.
- Always hold the grips on the fuel tank cap and turn it slowly to remove it.
A whooshing sound may be heard when the fuel tank cap is loosened.
Wait until the sound cannot be heard before fully removing the cap.
In hot weather, pressurized fuel may spray out of the filler neck and cause injury.
- Do not allow anyone that has not discharged static electricity from their bodies to come close to an open fuel tank.
- Do not inhale vaporized fuel.
Fuel contains substances that are harmful if inhaled.
- Do not smoke while refueling the vehicle.
Doing so may cause the fuel to ignite and cause a fire.
- Do not return to the vehicle or touch any person or object that is statically charged.
This may cause static electricity to build up, resulting in a possible ignition hazard.

■ **When replacing the fuel cap**

Do not use anything but a genuine Toyota fuel tank cap designed for your vehicle. Doing so may cause a fire or other incident which may result in death or serious injury.

**NOTICE****■ Refueling**

Do not spill fuel during refueling.

Doing so may damage the vehicle, such as causing the exhaust systems to operate abnormally or damaging fuel system components or the vehicle's painted surface.

■ To prevent damage to the fuel filler door

Do not apply excessive force.

■ E85 fuel

E85 fuel can be used only in flex-fuel vehicles. Do not add E85 fuel to a gasoline-engine vehicle.

Filling a gasoline-engine vehicle with E85 will have a negative impact on starting and driving performance and will cause damage to the fuel system components.

Engine immobilizer system*

The vehicle's keys have built-in transponder chips that prevent the engine from starting if the key has not been previously registered in the vehicle's on-board computer.

Never leave the keys inside the vehicle when you leave the vehicle.

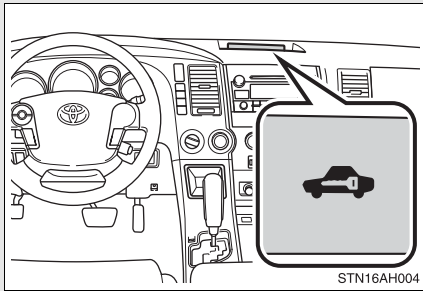

The indicator light flashes after the key has been removed from the engine switch to indicate that the system is operating.

The indicator light stops flashing after the registered key has been inserted into the engine switch to indicate that the system has been canceled.

■ System maintenance

The vehicle has a maintenance-free type engine immobilizer system.

■ Conditions that may cause the system to malfunction

- If the key is in contact with a metallic object
- If the key is in close proximity to or touching a key to the security system (key with a built-in transponder chip) of another vehicle

*: If equipped

■ Certifications for the engine immobilizer system

► For vehicles sold in U.S.A.

FCC ID: MOZRI-21BTY

This device complies with Part 15 of the FCC Rules. Operation is subject to the following two conditions: (1) this device may not cause harmful interference, and (2) this device must accept any interference received, including interference that may cause undesired operation.

FCC WARNING:

Changes or modifications not expressly approved by the party responsible for compliance could void the user's authority to operate the equipment.

► For vehicles sold in Canada

This device complied with RSS-210 of Industry Canada.

Operation is subject to the following two conditions: (1) this device may not cause interference, and (2) this device must accept any interference, including interference that may cause undesired operation of the device.



NOTICE

■ To ensure the system operates correctly

Do not modify or remove the system. If modified or removed, the proper operation of the system cannot be guaranteed.

Alarm*

The system sounds the alarm and flashes lights when forcible entry is detected.

■ Triggering of the alarm

The alarm is triggered in the following situations.

- A locked door is unlocked or opened in any way other than using the wireless remote control door lock function or key. The doors will lock again automatically.
- The hood is opened while the vehicle is locked.
- Vehicles with the glass breakage sensor (if equipped): The side windows are tapped or broken.
- The battery is reconnected.

■ Setting the alarm system

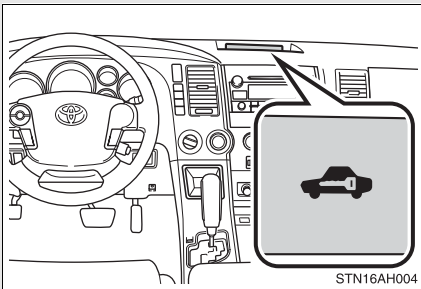

Close the doors and hood, and lock all the doors. The system will be set automatically after 30 seconds.

The indicator light changes from being on to flashing when the system is set.

■ Deactivating or stopping the alarm

- Unlock the doors.
- Turn the engine switch to the ACC or ON position, or start the engine.
(The alarm will be deactivated or stopped after a few seconds.)

*: If equipped

■ System maintenance

The vehicle has a maintenance-free type alarm system.

■ Items to check before locking the vehicle

To prevent unexpected triggering of the alarm and vehicle theft, make sure of the following.

- Nobody is in the vehicle.
- The windows and moon roof are closed before the alarm is set.
- No valuables or other personal items are left in the vehicle.

■ Triggering of the alarm

The alarm may be triggered in the following situations.
(Stopping the alarm deactivates the alarm system.)

- A person inside the vehicle opens a door or hood.
- The battery is recharged or replaced when the vehicle is locked.

■ Panic mode

→P. 44

■ When the battery is disconnected

Be sure to cancel the alarm system.

If the battery is discharged before canceling the alarm, the system may be triggered when the battery is reconnected.

■ Alarm-operated door lock

- When the alarm is operating, the doors are locked automatically to prevent intruders.
- Do not leave the key inside the vehicle when the alarm is operating, and make sure the key is not inside the vehicle when recharging or replacing the battery.

 **NOTICE**
■ To ensure the system operates correctly

Do not modify or remove the system. If modified or removed, the proper operation of the system cannot be guaranteed.

Correct driving posture

Drive in a good posture as follows:

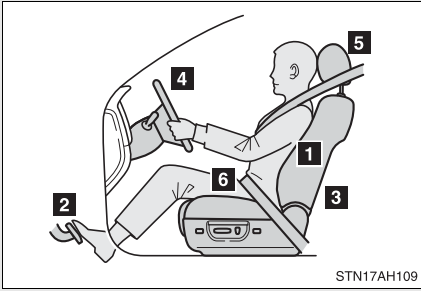

- 1** Sit upright and well back in the seat. (→P. 60)
- 2** Adjust the position of the seat forward or backward to ensure the pedals can be reached and easily depressed to the extent required. (→P. 60)
- 3** Adjust the seatback so that the controls are easily operable.
- 4** Adjust the tilt and telescopic positions of the steering wheel downward so the air-bag is facing your chest. (→P. 85, 87)
- 5** Lock the head restraint in place with the center of the head restraint closest to the top of your ears. (→P. 73)
- 6** Wear the seat belt correctly. (→P. 77)

 **CAUTION****■ While driving**

- Do not adjust the position of the driver's seat while driving.
Doing so could cause the driver to lose control of the vehicle.
- Do not place a cushion between the driver or passenger and the seatback.
A cushion may prevent correct posture from being achieved, and reduce the effectiveness of the seat belt and head restraint, increasing the risk of death or serious injury to the driver or passenger.
- Do not place anything under the front seats.
Objects placed under the front seats may become jammed in the seat tracks and stop the seat from locking in place. This may lead to an accident. The adjustment mechanism may also be damaged.

■ Adjusting the seat position

- Do not recline the seat more than necessary when the vehicle is in motion, to reduce the risk of sliding under the lap belt.
If the seat is too reclined during an accident, the lap belt may slide past the hips and apply restraint forces directly to the abdomen or your neck may contact the shoulder belt, increasing the risk of death or serious injury.
- Take care when adjusting the seat position to ensure that other passengers are not injured by the moving seat.
- Do not put your hands under the seat or near the moving parts to avoid injury.
Fingers or hands may become jammed in the seat mechanism.

SRS airbags

The SRS airbags inflate when the vehicle is subjected to certain types of severe impacts that may cause significant injury to the occupants. They work together with the seat belts to help reduce the risk of death or serious injury.

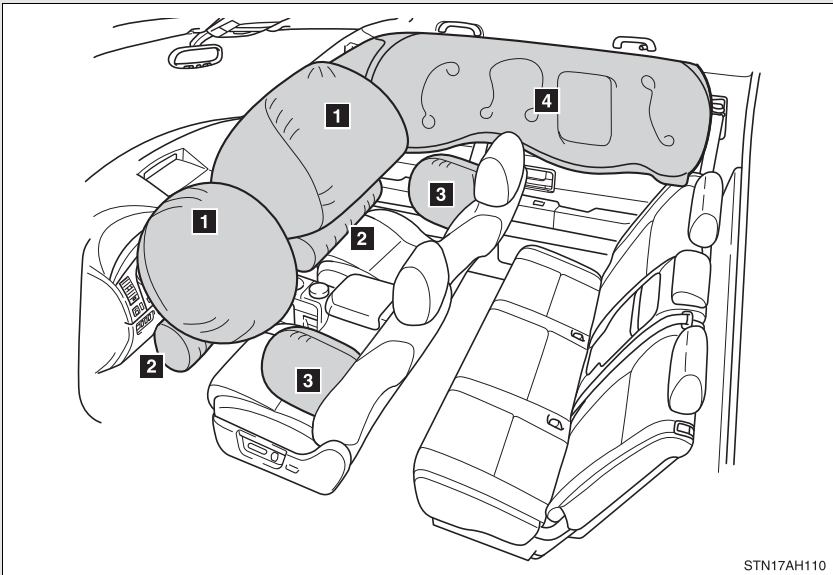

► Front airbags

1 Driver airbag/front passenger airbag

Can help protect the head and chest of the driver and right front passenger from impact with interior components.

2 Knee airbags

Can help provide driver and front passenger protection.

► Side and curtain shield airbags

3 Side airbags

Can help protect the torso of the front seat occupants.

4 Curtain shield airbags

Can help protect primarily the head of outside occupants.

Airbag system components

► Regular Cab models

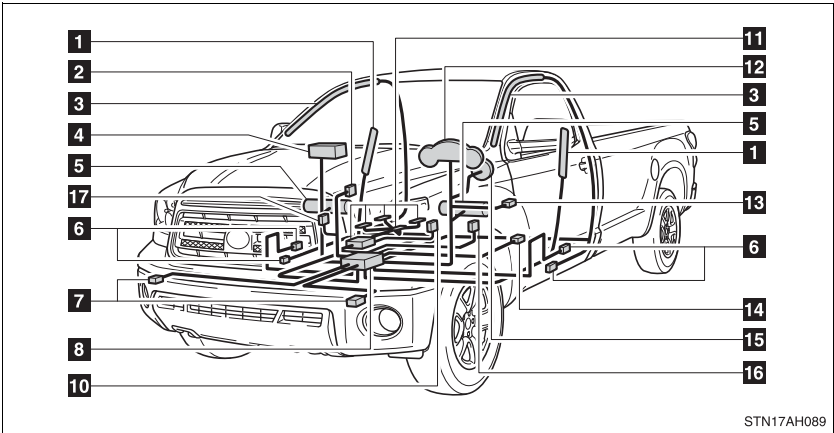

► Double Cab and CrewMax models

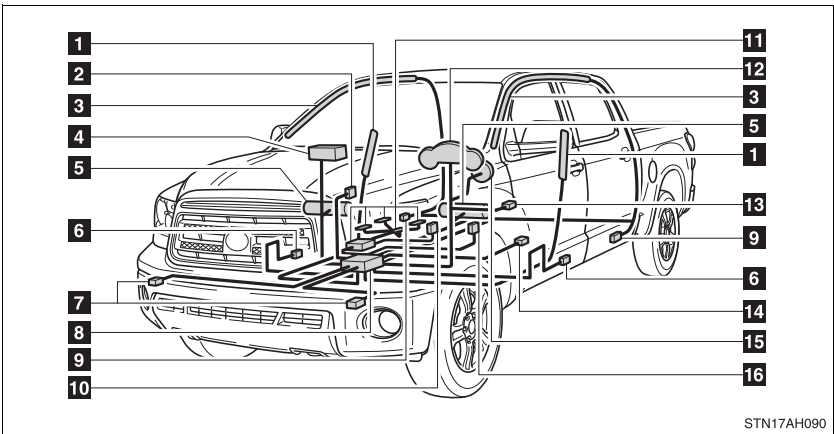

1
Before driving

- 1** Side airbags
- 2** AIR BAG ON and AIR BAG OFF indicator lights
- 3** Curtain shield airbags
- 4** Front passenger airbag
- 5** Knee airbags
- 6** Side and curtain shield airbag sensors
- 7** Front airbag sensors
- 8** Airbag sensor assembly
- 9** Curtain shield airbag sensors (Double Cab and CrewMax models)
- 10** Front passenger's seat belt buckle switch
- 11** Occupant detection system (ECU and sensors)
- 12** SRS warning light and RSCA OFF indicator light
- 13** RSCA OFF switch (4WD models only)
- 14** Driver's seat position sensor
- 15** Driver airbag
- 16** Driver's seat belt buckle switch
- 17** Passenger airbag off switch (Regular Cab models)

Your vehicle is equipped with ADVANCED AIRBAGS designed based on US motor vehicle safety standards (FMVSS208). The airbag system controls airbag deployment power for the driver and right front passenger. The driver airbag system consists of the driver seat's position sensor etc. The front passenger's airbag system consists of the front passenger occupant classification sensor etc.

The main SRS airbag system components are shown above. The SRS airbag system is controlled by the airbag sensor assembly. The airbag sensor assembly consists of a safing sensor and an airbag sensor.

Front bench type seat: The SRS airbags are designed to protect the driver and right front passenger, and they are not designed to protect an occupant in the front center seating position.

In certain types of severe frontal or side impacts, the SRS airbag system triggers the airbag inflators. A chemical reaction in the inflators quickly fills the airbags with non-toxic gas to help restrain the motion of the occupants.

■ SRS warning light

This warning light system monitors the airbag sensor assembly, front airbag sensors, side and curtain shield airbag sensor assemblies, curtain shield airbag sensor assemblies, driver's seat position sensor, driver's seat belt buckle switch, front passenger occupant classification system, AIR BAG ON and AIR BAG OFF indicator lights, front passenger's seat belt buckle switch, passenger airbag off switch (Regular Cab models), front seat belt pretensioner assemblies, RSCA OFF indicator light, inflators, interconnecting wiring and power sources. (→P. 596)

■ If the SRS airbags deploy (inflate)

- Bruising and slight abrasions may result from contact with a deploying (inflating) SRS airbag.
- A loud noise and white powder will be emitted.
- Parts of the airbag module (steering wheel hub, airbag cover and inflator) as well as the front seats, and parts of the front and rear pillars and roof side rail, may be hot for several minutes. The airbag itself may also be hot.
- The front windshield may crack.

■ Operating conditions (front airbags)

- The SRS front airbag will deploy in the event of an impact that exceeds the set threshold level (the level of force corresponding to an approximately 12-18 mph [20-30 km/h] frontal collision with a fixed wall that does not move or deform).

However, this threshold velocity will be considerably higher if the vehicle strikes an object, such as a parked vehicle or sign pole, which can move or deform on impact, or if the vehicle is involved in an underride collision (e.g. a collision in which the front of the vehicle "underrides", or goes under, the bed of a truck, etc.).

- It is possible that in some collisions where the forward deceleration of the vehicle is very close to the designed threshold level, the SRS front airbags and the seat belt pretensioners may not activate together.
- The SRS front passenger airbag will not activate if there is no passenger sitting in the right front passenger seat. However, the front passenger airbag may deploy if luggage is put in the seat, or the seat belt is fastened, even if the seat is unoccupied. (→P. 136)

■ **Operating conditions (side airbags and curtain shield airbags)**

The SRS side airbags and SRS curtain shield airbags will deploy in the event of an impact that exceeds the set threshold level (the level of force corresponding to the impact force produced by an approximately 3307 lb. [1500 kg] vehicle colliding with the vehicle cabin from a direction perpendicular to the vehicle orientation at an approximately speed of 12-18 mph [20-30 km/h]).

■ **Operating conditions (side airbags)**

The SRS side airbag on the passenger seat will activate even if there is no passenger sitting in the right front passenger seat. (→P. 136)

■ **Operating conditions (curtain shield airbags)**

The SRS curtain shield airbags are designed to inflate when the passenger compartment is subjected to a severe impact from the side or vehicle roll-over.

■ **Conditions under which the SRS airbags may deploy (inflate), other than a collision**

The SRS front airbags may also deploy if a serious impact occurs to the underside of your vehicle. Some examples are shown in the illustration.

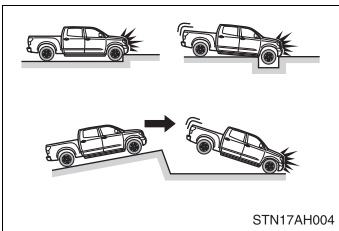

- Hitting a curb, edge of pavement or hard surface
- Falling into or jumping over a deep hole
- Landing hard or vehicle falling

The SRS curtain shield airbags may also deploy under the situation shown in the illustration.

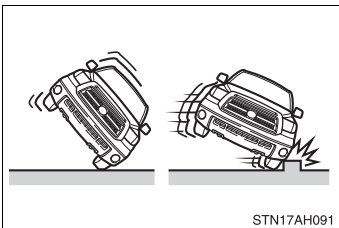

- The angle of vehicle tip-up is marginal.
- The vehicle skids and hits a curb stone.

■ Types of collisions that may not deploy the SRS airbag (front airbags)

The SRS front airbags are generally not designed to inflate if the vehicle is involved in a side or rear collision, if it rolls over, or if it is involved in a low-speed frontal collision. But, whenever a collision of any type causes sufficient forward deceleration of the vehicle, deployment of the SRS front airbags may occur.

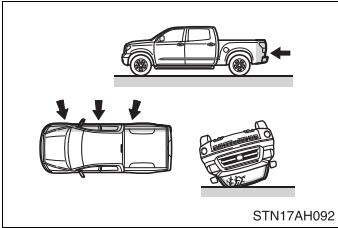

- Collision from the side
- Collision from the rear
- Vehicle rollover

■ Types of collisions that may not deploy the SRS airbag (side airbags and curtain shield airbags)

The SRS side airbag and curtain shield airbag system may not activate if the vehicle is subjected to a collision from the side at certain angles, or a collision to the side of the vehicle body other than the passenger compartment.

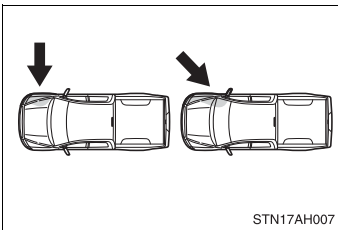

- Collision from the side to the vehicle body other than the passenger compartment
- Collision from the side at an angle

The SRS side airbags are not generally designed to inflate if the vehicle is involved in a frontal or rear collision, if it rolls over, or if it is involved in a low-speed side collision.

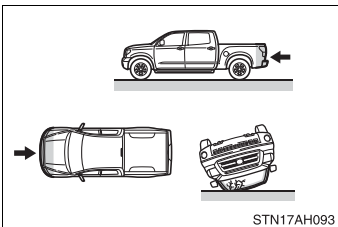

- Collision from the front
- Collision from the rear
- Vehicle rollover

The SRS curtain shield airbags are not generally designed to inflate if the vehicle is involved in a frontal or rear collision, if it pitches end over end, or if it is involved in a low-speed side collision.

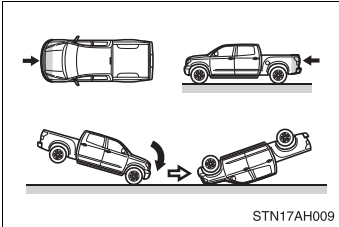

- Collision from the front
- Collision from the rear
- Pitching end over end

■ When to contact your Toyota dealer

In the following cases, contact your Toyota dealer as soon as possible. Do not disconnect the battery cables before contacting your Toyota dealer.

- Any of the SRS airbags have been inflated.

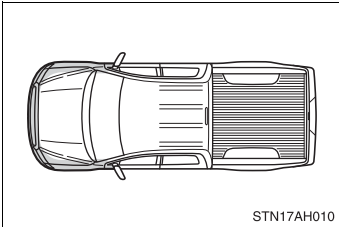

- The front of the vehicle is damaged or deformed, or was involved in an accident that was not severe enough to cause the SRS airbags to inflate.

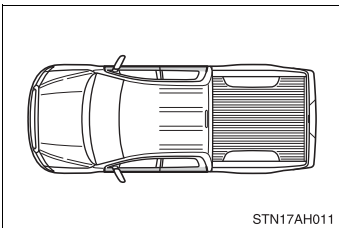

- A portion of a door is damaged or deformed, or the vehicle was involved in an accident that was not severe enough to cause the SRS side airbags and curtain shield airbags to inflate.

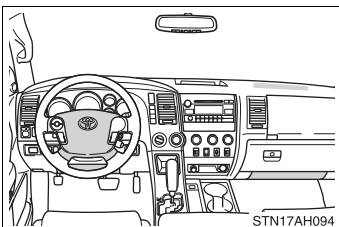

- The pad section of the steering wheel, dashboard near the front passenger airbag or lower portion of the instrument panel is scratched, cracked or otherwise damaged.

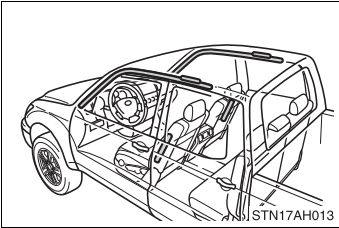

- The surface of the seats with the side airbag is scratched, cracked or otherwise damaged.
- The portion of the front pillars, rear pillars or roof side rail garnishes (padding) containing the curtain shield airbags inside is scratched, cracked or otherwise damaged.

⚠ CAUTION

■ SRS airbag precautions

Observe the following precautions regarding the airbags. Failure to do so may cause death or serious injury.

- The driver and all passengers in the vehicle must wear their seat belts properly.

The SRS airbags are supplemental devices to be used with the seat belts.

- The SRS driver airbag deploys with considerable force, and can cause death or serious injury especially if the driver is very close to the airbag. The National Highway Traffic Safety Administration (“NHTSA”) advises:

Since the risk zone for the driver’s airbag is the first 2 - 3 in. (50 - 75 mm) of inflation, placing yourself 10 in. (250 mm) from your driver airbag provides you with a clear margin of safety. This distance is measured from the center of the steering wheel to your breastbone. If you now sit less than 10 in. (250 mm) away, you can change your driving position in several ways:

- Move your seat to the rear as far as you can while still reaching the pedals comfortably.
- Slightly recline the back of the seat.
Although vehicle designs vary, many drivers can achieve the 10 in. (250 mm) distance, even with the driver seat all the way forward, simply by reclining the back of the seat somewhat. If reclining the back of your seat makes it hard to see the road, raise yourself by using a firm, non-slippery cushion, or raise the seat if your vehicle has that feature.
- If your steering wheel is adjustable, tilt it downward. This points the airbag toward your chest instead of your head and neck.

! CAUTION

■ SRS airbag precautions

The seat should be adjusted as recommended by NHTSA above, while still maintaining control of the foot pedals and steering wheel, and your view of the instrument panel controls.

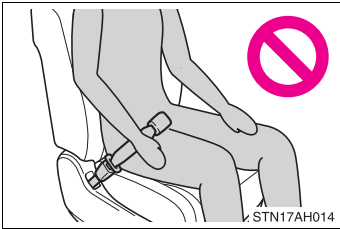

● If the seat belt extender has been connected to the driver's seat belt buckle but the seat belt extender has not also been fastened to the latch plate of the driver's seat belt, the SRS driver's airbag system will judge that the driver is wearing the seat belt even though the seat belt has not been connected. In this case, the driver's airbag may not activate correctly in a collision, resulting in death or serious injury in the event of collision. Be sure to wear the seat belt with the seat belt extender.

- The SRS front passenger airbag also deploys with considerable force, and can cause death or serious injury especially if the front passenger is very close to the airbag. The front passenger seat should be as far from the airbag as possible with the seatback adjusted, so the front passenger sits upright.
- Improperly seated and/or restrained infants and children can be killed or seriously injured by a deploying airbag. An infant or child who is too small to use a seat belt should be properly secured using a child restraint system. Toyota strongly recommends that all infants and children be placed in the rear seats of the vehicle and properly restrained. The rear seats are the safest for infants and children. (→P. 143)

 CAUTION

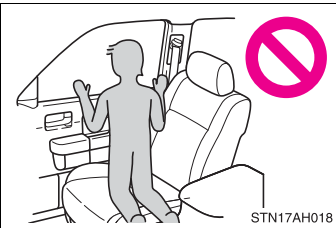
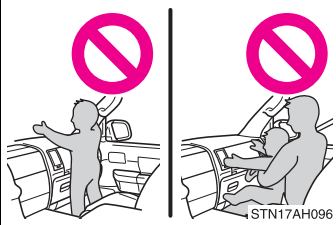
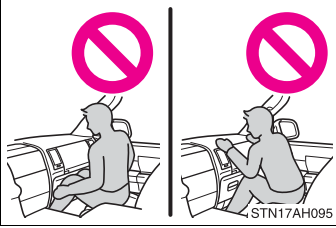
■ SRS airbag precautions

- Do not sit on the edge of the seat or lean against the dashboard.
- Do not allow a child to stand in front of the SRS front passenger airbag unit or sit on the knees of a front passenger.
- Do not drive the vehicle while the driver or passenger has items resting on their knees.
- Do not lean against the door, the roof side rail or the front, side and rear pillars.
- Do not allow anyone to kneel on the passenger seat toward the door or put their head or hands outside the vehicle.

⚠ CAUTION

■ SRS airbag precautions

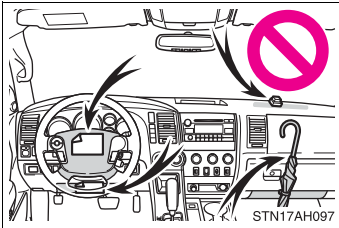

- Do not attach anything to or lean anything against areas such as the dashboard, steering wheel pad or lower portion of the instrument panel.

These items can become projectiles when SRS driver, front passenger and knee airbags deploy.

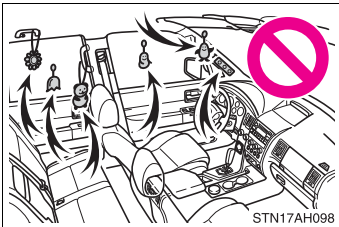

- Do not attach anything to areas such as the door, windshield glass, side door glass, front and rear pillars, roof side rail or assist grip.

- Do not hang coat hangers or other hard objects on the coat hooks. All of these items could become projectiles and seriously injure or kill you, should the SRS curtain shield airbag deploy.

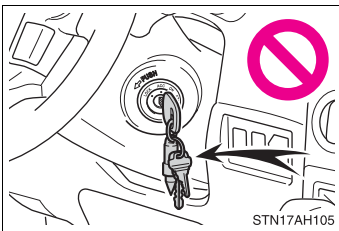

- Do not attach any heavy, sharp or hard objects such as keys or accessories to the key. The objects may restrict the SRS knee airbag inflation or be thrust into the driver's seat area by the force of the deploying airbag, thus causing a danger.

- If the vinyl cover is put on the area where the SRS knee airbag will deploy, be sure to remove it.
- Do not use seat accessories which cover the parts where the SRS side airbags inflate as they may interfere with inflation of the airbags.
- Do not strike or apply significant levels of force to the area of the SRS airbag components (→P. 121).
Doing so can cause the SRS airbags to malfunction.
- Do not touch any of the component parts immediately after the SRS airbags have deployed (inflated) as they may be hot.

 **CAUTION**
■ SRS airbag precautions

- If breathing becomes difficult after the SRS airbag has deployed, open a door or window to allow fresh air in, or leave the vehicle if it is safe to do so. Wash off any residue as soon as possible to prevent skin irritation.
- If the areas where the SRS airbags are stored, such as the steering wheel pad and front and rear pillar garnishes, are damaged or cracked, have them replaced by your Toyota dealer.

■ Modification and disposal of SRS airbag system components

Do not dispose of your vehicle or perform any of the following modifications without consulting your Toyota dealer.

The SRS airbags may malfunction or deploy (inflate) accidentally, causing death or serious injury.

- Installation, removal, disassembly and repair of the SRS airbags.
- Repairs, modifications, removal or replacement of the steering wheel, instrument panel, dashboard, seats or seat upholstery, front, side and rear pillars or roof side rails.
- Repairs or modifications of the front fender, front bumper, or side of the occupant compartment.
- Installation of snow plows, winches, etc. to the front grille (bull bars, kangaroo bar etc.).
- Modifications to the vehicle's suspension system.
- Do not use tires or wheels other than the manufacturer's recommended size. (→P. 666)
- Installation of electronic devices such as mobile two-way radios or CD players.
- Modifications to your vehicle for a person with a physical disability.

Passenger airbag off switch (Regular Cab models)

The passenger airbag off switch is designed to disable the front passenger airbag in order to allow usage, if necessary, of the right passenger seat by a member of a passenger risk group identified in TABLE 1 (→P. 133).

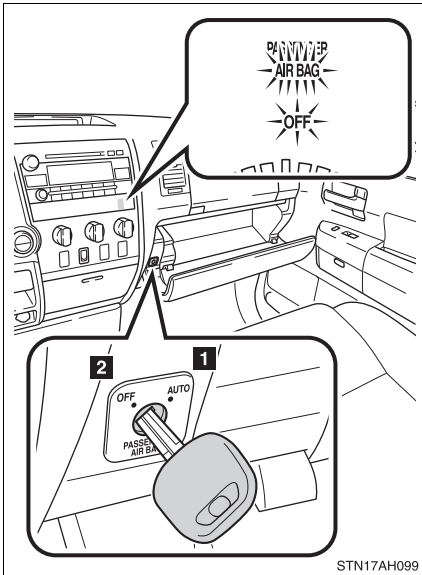

1 AUTO position

This position makes the front passenger airbag system operational.

At this time, the indicator light condition varies depending on the size of the occupant in the right passenger seat.

2 OFF position

The front passenger airbag is disabled.

At this time, the AIR BAG OFF indicator light will come on.

■ Operation of the passenger airbag off switch

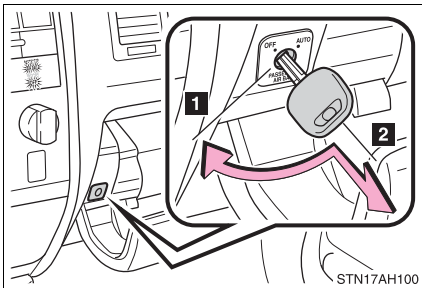

1 Turn the key clockwise to the AUTO position.

2 Turn the key counterclockwise to the OFF position and remove it.

If the key is removed at any other position than OFF, the switch will automatically return to the AUTO position.

■ Passenger risk group

TABLE 1: A PASSENGER RISK GROUP

<p>Infant. An infant (less than 1 year old) who must ride in the front seat because:</p> <ul style="list-style-type: none"> • Vehicle has no rear seat; • Vehicle has a rear seat too small to accommodate a rear-facing infant seat; or • The infant has a medical condition which, according to the infant's physician, makes it necessary for the infant to ride in the front seat so that the driver can constantly monitor the child's condition.
<p>Child age 1 to 12. A child age 1 to 12 must ride in the front seat because:</p> <ul style="list-style-type: none"> • Vehicle has no rear seat; • Although children ages 1 to 12 ride in the rear seat(s) whenever possible, children ages 1 to 12 sometimes must ride in the front because no space is available in the rear seat(s) of vehicle; or • The child has a medical condition which, according to the child's physician, makes it necessary for the child to ride in the front seat so that the driver can constantly monitor the child's condition.
<p>Medical condition. A passenger has a medical condition which according to his or her physician:</p> <ul style="list-style-type: none"> • Causes the passenger airbag to pose a special risk for the passenger: and • Makes the potential harm from the passenger airbag in a crash greater than the potential harm from turning off the airbag and allowing the passenger, even if belted, to hit the dashboard, or windshield in a crash.

For more detailed information concerning about the passenger risk group, please contact NHTSA at 1-888-327-4236 or Transport Canada at 1-800-333-0371.

! CAUTION

■ When the passenger airbag off switch is turned off

- Do not turn the passenger airbag off switch to the OFF position except when a member of a passenger risk group identified in TABLE 1 is occupying the right passenger seating position.
- The front passenger airbag will not inflate in a collision and turning off the front passenger airbag can reduce the occupant protection which your vehicle safety systems can provide to you in certain accidents and increase the likelihood of death or serious injuries.

Deactivating the curtain shield airbags in a vehicle rollover (4WD models only)

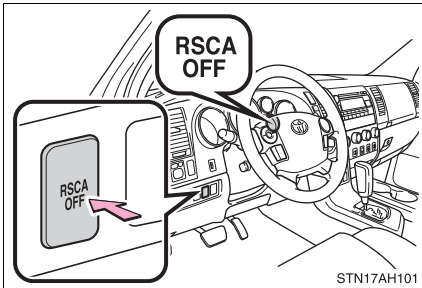

ON/OFF (hold for a few seconds)

The RSCA OFF indicator turns on. (only when the engine switch is in the ON position.)

The roll sensing function for the curtain shield airbags and seat belt pretensioners will turn back on automatically each time the engine switch is turned on.

■ The switch only should be used

In a situation where inflation is not desired (such as during extreme off-road driving).

■ Operating conditions when the RSCA OFF indicator is on

- The curtain shield airbag and seat belt pretensioner will not activate in a vehicle rollover.
- The curtain shield airbag will activate in a severe side impact.

 CAUTION**■ For normal driving**

Make sure the RSCA OFF indicator is not turned on. If it is left on, the curtain shield airbag will not activate in the event of an accident, which may result in death or serious injury.

1

Before driving

Front passenger occupant classification system

Your vehicle is equipped with a front passenger occupant classification system. This system detects the conditions of the right front passenger seat and activates or deactivates the devices for the front passenger.

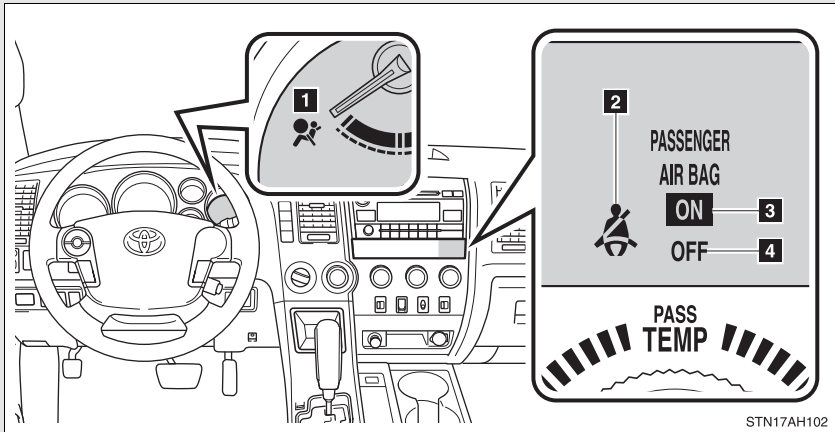

- 1** SRS warning light
- 2** Front passenger's seat belt reminder light
- 3** AIR BAG ON indicator light
- 4** AIR BAG OFF indicator light

Conditions and operation of the front passenger occupant classification system

► Regular Cab models

● Indicator/warning light

Condition detected by the front passenger occupant classification system*1	Passenger airbag off switch position	AIR BAG ON and AIR BAG OFF indicator lights	SRS warning light	Front passenger's seat belt reminder light
Adult*2	AUTO	AIR BAG ON	Off	Flashing*5
	OFF	AIR BAG OFF		
Child*3 or child restraint system*4	AUTO	AIR BAG OFF*6	Off	Flashing*5
	OFF			
Unoccupied	AUTO	Not illuminated	Off	Off
	OFF	AIR BAG OFF		
There is a malfunction in the system	AUTO	AIR BAG OFF	On	Off
	OFF			

● Devices

Condition detected by the front passenger occupant classification system*1	Passenger airbag off switch position	Front passenger airbag	Front passenger knee airbag	Side airbag on the passenger seat	Curtain shield airbag in the passenger side	Front passenger's seat belt pretensioner
Adult*2	AUTO	Activated		Activated		
	OFF	Deactivated	Activated	Activated		
Child*3 or child restraint system*4	AUTO	Deactivated	Activated	Activated	Activated	
	OFF					Activated
Unoccupied	AUTO	Deactivated	Activated		Deactivated	
	OFF					
There is a malfunction in the system	AUTO	Deactivated	Activated	Activated		
	OFF					

*1: The right passenger on the bench type seat.

*2: The system judges a person of adult size as an adult. When a smaller adult sits in the passenger seat, the system may recognize him/her as a child depending on his/her physique and posture.

*3: When a larger child who has outgrown a child restraint system sits in the passenger seat, the system may recognize him/her as an adult depending on his/her physique or posture.

*4: Never install a rear-facing child restraint system on the passenger seat. A forward-facing child restraint system should only be installed on the passenger seat when it is unavoidable. (→P. 143)

*5: In the event the passenger does not wear a seat belt.

*6: In case the indicator is not illuminated, consult this manual for installing the child restraint system properly. (→P. 143)

► Double Cab and CrewMax models

● Indicator/warning light

Condition detected by the front passenger occupant classification system*1	AIR BAG ON and AIR BAG OFF indicator lights	SRS warning light	Front passenger's seat belt reminder light
Adult*2	AIR BAG ON	Off	Flashing*5
Child*3 or child restraint system*4	AIR BAG OFF*6	Off	Flashing*5
Unoccupied	Not illuminated	Off	Off
There is a malfunction in the system	AIR BAG OFF	On	Off

● Devices

Condition detected by the front passenger occupant classification system*1	Front passenger airbag	Front passenger knee airbag	Side airbag on the front passenger seat	Curtain shield airbag in the front passenger side	Front passenger's seat belt pretensioner
Adult*2	Activated				
Child*3 or child restraint system*4	Deactivated		Activated		Activated
Unoccupied	Deactivated		Activated	Activated	Deactivated
There is a malfunction in the system	Deactivated		Activated		Activated

- *1: The right front passenger on the bench type seat.
- *2: The system judges a person of adult size as an adult. When a smaller adult sits in the front passenger seat, the system may recognize him/her as a child depending on his/her physique and posture.
- *3: When a larger child who has outgrown a child restraint system sits in the front passenger seat, the system may recognize him/her as an adult depending on his/her physique or posture.
- *4: Never install a rear-facing child restraint system on the front passenger seat. A forward-facing child restraint system should only be installed on the front passenger seat when it is unavoidable. (→P. 143)
- *5: In the event the front passenger does not wear a seat belt.
- *6: In case the indicator is not illuminated, consult this manual for installing the child restraint system properly. (→P. 143)

 CAUTION

■ Front passenger occupant classification system precautions

Observe the following precautions regarding front passenger occupant classification system.

Failure to do so may cause death or serious injury.

- Wear the seat belt properly.
- Make sure the front passenger's seat belt tab has not been left inserted into the buckle before someone sits in the front passenger seat.
- Make sure the AIR BAG OFF indicator light is not illuminated when using the seat belt extender for the right front passenger seat. If the AIR BAG OFF indicator light is illuminated, disconnect the extender tongue from the seat belt buckle, then reconnect the seat belt. Reconnect the seat belt extender after making sure the AIR BAG ON indicator light is illuminated. If you use the seat belt extender while the AIR BAG OFF indicator light is illuminated, the front passenger airbag, front passenger knee airbag and side airbag on the right front passenger side airbag may not activate correctly, which could cause death or serious injury in the event of collision.

 CAUTION**Front passenger occupant classification system precautions**

- Do not apply a heavy load to the front passenger seat or equipment (e.g. seatback pocket).
- Do not apply pressure to the right front passenger seat by resting hands or legs on the seatback.
- Double Cab and CrewMax models: Do not put weight on the front passenger seat by putting your hands or feet on the front passenger seat seatback from the rear passenger seat.
- Double Cab and CrewMax models: Do not let a rear passenger lift the front passenger seat with their feet or press on the seatback with their legs.
- Do not put objects under the front passenger seat.
- Do not recline the front passenger seatback so far that it touches a rear seat or a back wall. This may cause the AIR BAG OFF indicator light to be illuminated, which indicates that the passenger's airbags will not deploy in the event of a severe accident. If the seatback touches the rear seat or back wall, return the seatback to a position where it does not touch the rear seat or back wall. Keep the front passenger seatback as upright as possible when the vehicle is moving. Reclining the seatback excessively may lessen the effectiveness of the seat belt system.
- If an adult sits in the right front passenger seat, the AIR BAG ON indicator light is illuminated. If the AIR BAG OFF indicator is illuminated, ask the passenger to sit up straight, well back in the seat, feet on the floor, and with the seat belt worn correctly. If the AIR BAG OFF indicator still remains illuminated, either ask the passenger to move to the rear seat, or if that is not possible, move the right front passenger seat fully rearward.
- When it is unavoidable to install the forward-facing child restraint system on the front passenger seat, install the child restraint system on the front passenger seat in the proper order. (→P. 149)
- Do not modify or remove the front seats.
- Do not kick the front passenger seat or subject it to severe impact. Otherwise, the SRS warning light may come on to indicate a malfunction of the detection system. In this case, contact your Toyota dealer immediately.

 CAUTION

■ **Front passenger occupant classification system precautions**

- Double Cab and CrewMax models: Child restraint systems installed on the rear seat should not contact the front seatbacks.
- Do not use a seat accessory, such as a cushion or seat cover, that covers the seat cushion surface.
- Do not attach a commercial seatback table or other heavy item to the back of the front passenger seat.
- Do not modify or replace the upholstery of the front seat.

1-7. Safety information

Child restraint systems

A child restraint system for a small child or baby must itself be properly restrained on the seat with the lap portion of the lap/shoulder belt.

The laws of all 50 states of the U.S.A. and Canada now require the use of child restraint systems.

1

Before driving

Points to remember

Studies have shown that installing a child restraint on a rear seat is much safer than installing one to the front passenger seat.

- Choose a child restraint system that suits your vehicle and is appropriate to the age and size of the child.
- For installation details, follow the instructions provided with the child restraint system.

General installation instructions are provided in this manual.

(→P. 149)

Types of child restraints

Child restraint systems are classified into the following 3 types according to the age and size of the child.

- ▶ Rear facing — Infant seat/convertible seat



► Forward facing — Convertible seat



► Booster seat



■ Selecting an appropriate child restraint system

- Use a child restraint system appropriate for the child until the child becomes large enough to properly wear the vehicle's seat belt.
- If a child is too large for a child restraint system, sit the child on a rear seat and use the vehicle's seat belt. (→P. 77)

 CAUTION**■ Child restraint precautions**

- For effective protection in automobile accidents and sudden stops, a child must be properly restrained, using a seat belt or child restraint system depending on the age and size of the child. Holding a child in your arms is not a substitute for a child restraint system. In an accident, the child can be crushed against the windshield, or between you and the vehicle's interior.
- Regular Cab models: Toyota strongly urges use of a proper child restraint system which conforms to the size of the child.
- Double Cab and CrewMax models: Toyota strongly urges the use of a proper child restraint system that conforms to the size of the child, installed on the rear seat. According to accident statistics, the child is safer when properly restrained in the rear seat than in the front seat.
- Regular Cab models: Never put infant or child age 1 to 12 in a passenger risk group on the right passenger seat with the passenger airbag off switch in the AUTO position. In the event of an accident, the force of the rapid inflation of the front passenger airbag can cause death or serious injury to the child. If you must put infant or child age 1 to 12 in a passenger risk group on the right passenger seat, make sure that the passenger airbag off switch is in the OFF position with the key removed and that the indicator light is on. (→P. 132)
- Double Cab and CrewMax models: Never install a rear-facing child restraint system on the front passenger seat even if the AIR BAG OFF indicator light is illuminated. In the event of an accident, the force of the rapid inflation of the front passenger airbag can cause death or serious injury to the child if the rear-facing child restraint system is installed on the front passenger seat.

CAUTION

Child restraint precautions

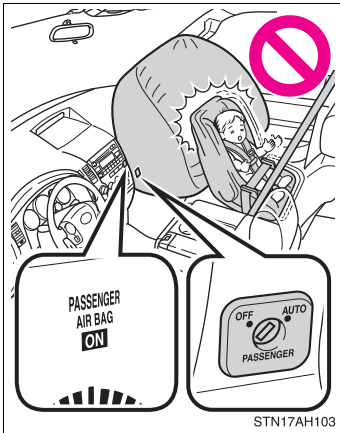

- Regular Cab models: Never install a rear-facing child restraint system on the right passenger seat with the passenger airbag off switch in the AUTO position. In the event of an accident, the force of the rapid inflation of the front passenger airbag can cause death or serious injury to the child if the rear-facing child restraint system is installed on the right passenger seat.
- Regular Cab models: If you must install a rear-facing child restraint system on the right passenger seat, make sure that the passenger airbag off switch is in the OFF position with the key removed and that the indicator light is on.

- Regular Cab models (Bench type seat): Never install a rear-facing child restraint system on the center seat even if the passenger airbag off switch is in the OFF position. In the event of an accident, the force of the rapid inflation of the driver airbag could cause death or serious injury to the child.
- Double Cab and CrewMax models: A forward-facing child restraint system may be installed on the front passenger seat only when it is unavoidable. A child restraint system that requires a top tether strap should not be used in the front passenger seat since there is no top tether strap anchor for the front passenger seat. Adjust the seatback as upright as possible and always move the seat as far back as possible even if the AIR BAG OFF indicator light is illuminated, because the front passenger airbag could inflate with considerable speed and force. Otherwise, the child may be killed or seriously injured.

 CAUTION**■ Child restraint precautions**

- Regular Cab models: A forward-facing child restraint system which belongs to a passenger risk group should never be installed on the right passenger seat with the passenger airbag off switch in the AUTO position, because the force of the deploying airbag could cause death or serious injury to the child in forward seating position. (→P. 133)
- Regular Cab models (Bench type seat): Do not install a child restraint system on the center seat if it interferes with driving operations such as changing the shift lever position. In this case, install the child restraint system on the right passenger seat.
- Do not use the seat belt extender when installing a child restraint system on the front or rear passenger seat. If installing a child restraint system with the seat belt extender connected to the seat belt, the seat belt will not securely hold the child restraint system, which could cause death or serious injury to the child or other passengers in the event of a sudden stop, sudden swerve or an accident.
- Do not allow the child to lean his/her head or any part of his/her body against the door or the area of the seat, front and rear pillars or roof side rail from which the side airbags or curtain shield airbags deploy even if the child is seated in the child restraint system. It is dangerous if the side airbags and curtain shield airbags inflate, and the force of the rapid inflation could cause death or serious injury to the child.
- Make sure you have complied with all installation instructions provided by the child restraint manufacturer and that the system is properly secured. If it is not secured properly, it may cause death or serious injury to the child in the event of a sudden stop, sudden swerve or an accident.

■ Child restraint lock function belt precaution

Do not allow children to play with the child restraint lock function belt. If the belt becomes twisted around a child's neck, it will not be possible to pull the belt out leading to choking or other serious injuries that could result in death. If this occurs and the buckle cannot be unfastened, scissors should be used to cut the belt.

 CAUTION

■ **When the child restraint system is not in use**

- Keep the child restraint system properly secured on the seat even if it is not in use. Do not store the restraint unsecured in the passenger compartment.
- If it is necessary to detach the child restraint system, remove it from the vehicle. This will prevent it from injuring passengers in the event of a sudden stop, sudden swerve or accident.

Installing child restraints

Follow the child restraint system manufacturer's instructions. Firmly secure child restraints to the seats using the LATCH anchors or a seat belt. Attach the top tether strap when installing a child restraint.

The lap/shoulder belt can be used if your child restraint system is not compatible with the LATCH (Lower Anchors and Tethers for Children) system.

Child restraint LATCH anchors

► Regular Cab models

LATCH anchors are provided for the right passenger seat.

Buttons displaying the location of the anchors are attached to the seat.

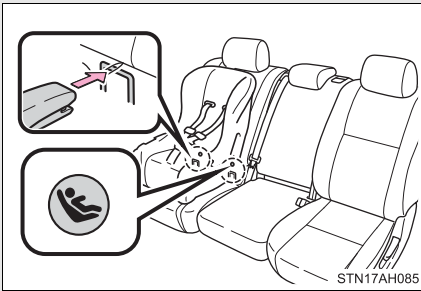

► Double Cab models

LATCH anchors are provided for the outside rear seats.

Buttons displaying the location of the anchors are attached to the seats.

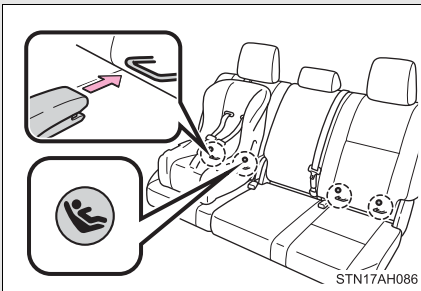

► CrewMax models

LATCH anchors are provided for the outside rear seats.

Buttons displaying the location of the anchors are attached to the seats.

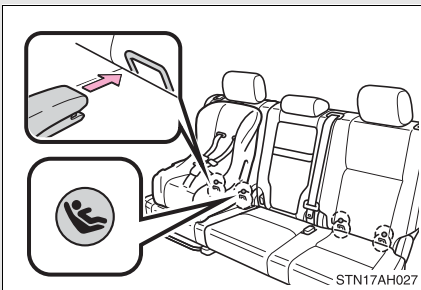

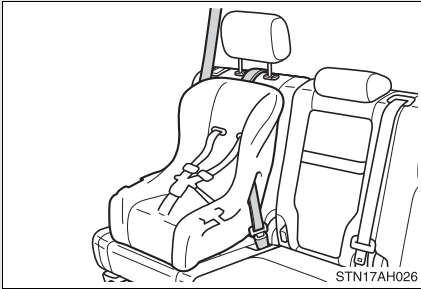

Seat belts equipped with a child restraint locking mechanism (ALR/ELR belts except driver's seat belt) (→P. 81)

Anchor bracket (for top tether strap)

► Regular Cab models

Anchor brackets are provided for all passenger seats.

- 1 Separated type seat
- 2 Bench type seat

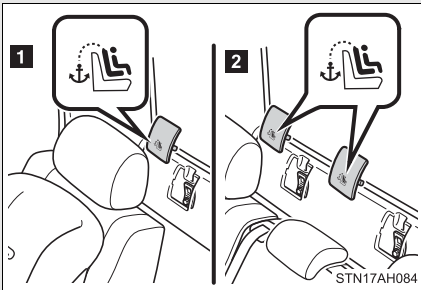

► Double Cab models

Anchor brackets are provided for all rear passenger seats.

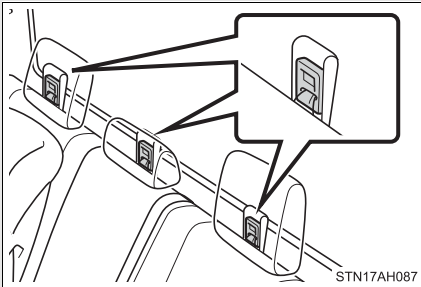

► CrewMax models

Anchor brackets are provided for all rear passenger seats.

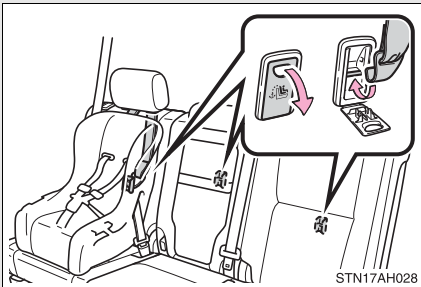

Installing the child restraint system on the right passenger seat (Regular Cab models)

When you install a child restraint system which belongs to a passenger risk group on the right passenger seat, do the following procedure.

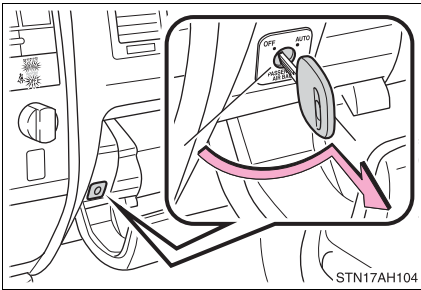

Turn the passenger airbag off switch counterclockwise to the OFF position and remove the key.

The AIR BAG OFF indicator light comes on when the front passenger airbag system is off. (→P. 132)

⚠ CAUTION

■ Rear-facing child restraint system

If you must install a rear-facing child restraint system on the right passenger seat, make sure that the passenger airbag off switch is in the OFF position with the key removed and that the indicator light is on.

■ Forward-facing child restraint system

A forward-facing child restraint system which belongs to a passenger risk group should never be installed on the right passenger seat with the passenger airbag off switch in the AUTO position, because the force of the deploying airbag could cause death or serious injury to the child in forward seating position. (→P. 133)

Installation with LATCH system (Regular Cab models)

■ Installing on the right passenger seat (vehicles without seat-back table)

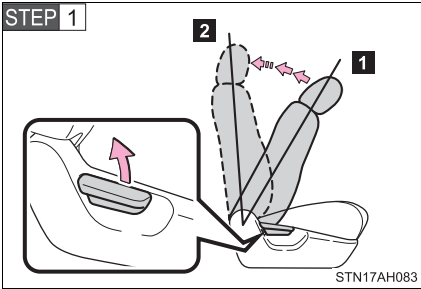

Fold the seatback while pulling the lever. Return the seatback and secure it at the 1st lock position (most upright position). Adjust the seatback to the 13th lock position. (→P. 63)

- 1** 1st lock position
- 2** 13th lock position

► Type A

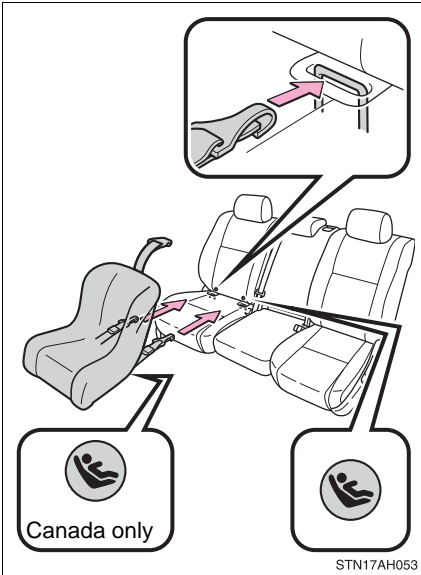

STEP 2 Latch the hooks of the lower straps onto the LATCH anchors and tighten the lower straps.

STEP 3 If the child restraint has a top tether strap, the top tether strap should be latched onto the top tether strap anchor. (→P. 161)

For owners in Canada:
The symbol on a child restraint system indicates the presence of a lower connector system.

► Type B

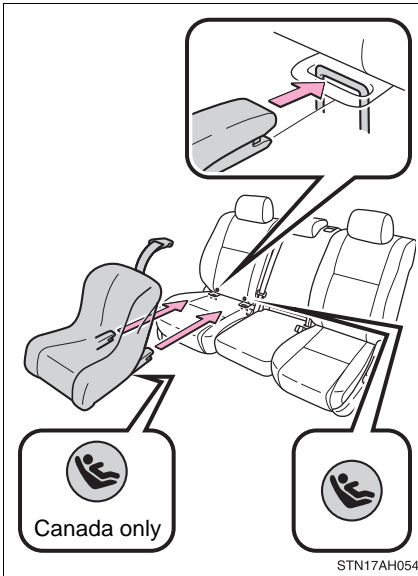

STEP 2 Latch the buckles onto the LATCH anchors.

STEP 3 If the child restraint has a top tether strap, the top tether strap should be latched onto the top tether strap anchor. (→P. 161)

For owners in Canada:
The symbol on a child restraint system indicates the presence of a lower connector system.

■ Installing on the right passenger seat (vehicles with seatback table)

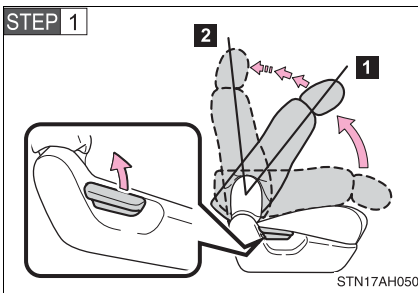

Fold down the seatback and back to the 1st lock position (most upright position) until it locks into place. Adjust the seatback to the 13th lock position. (→P. 63)

1 1st lock position

2 13th lock position

► Type A

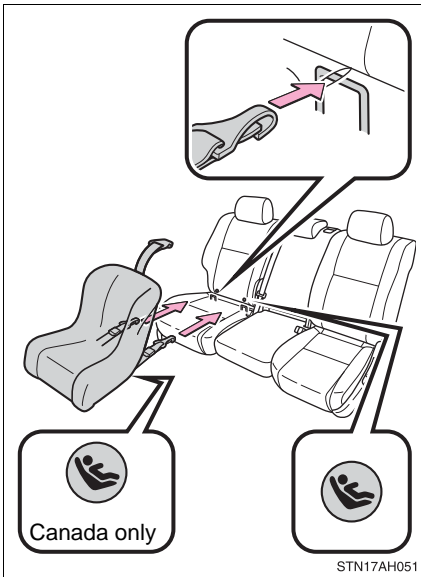

STEP 2 Widen the slits of the seat cushion slightly.

STEP 3 Latch the hooks of the lower straps onto the LATCH anchors and tighten the lower straps.

STEP 4 If the child restraint has a top tether strap, the top tether strap should be latched onto the top tether strap anchor. (→P. 161)

For owners in Canada:

The symbol on a child restraint system indicates the presence of a lower connector system.

► Type B

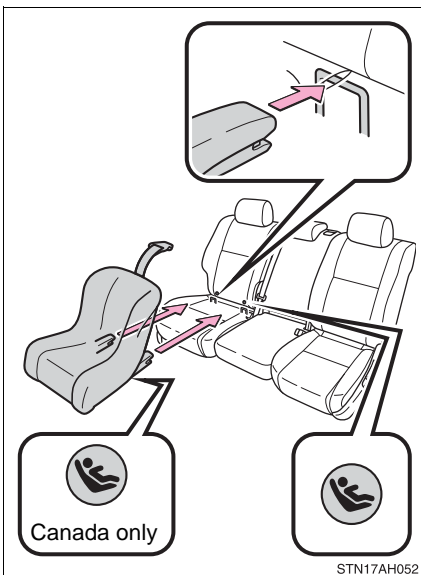

STEP 2 Widen the slits of the seat cushion slightly.

STEP 3 Latch the buckles onto the LATCH anchors.

STEP 4 If the child restraint has a top tether strap, the top tether strap should be latched onto the top tether anchor. (→P. 161)

For owners in Canada:

The symbol on a child restraint system indicates the presence of a lower connector system.

Installation with LATCH system (Double Cab models)

► Type A

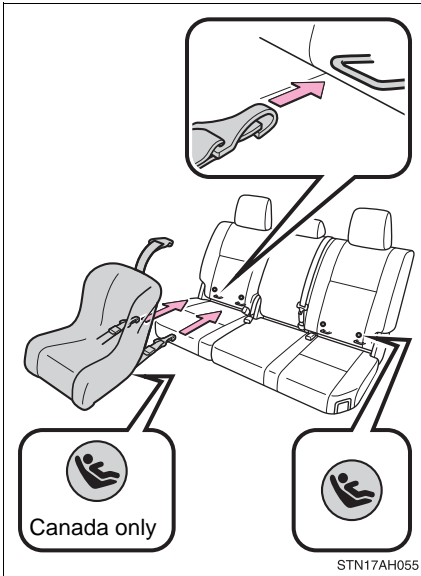

STEP 1 Widen the gap between the seat cushion and seatback slightly.

STEP 2 Latch the hooks of the lower straps onto the LATCH anchors and tighten the lower straps.

STEP 3 If the child restraint has a top tether strap, the top tether strap should be latched onto the top tether strap anchor. (→P. 163)

For owners in Canada:
The symbol on a child restraint system indicates the presence of a lower connector system.

1

Before driving

► Type B

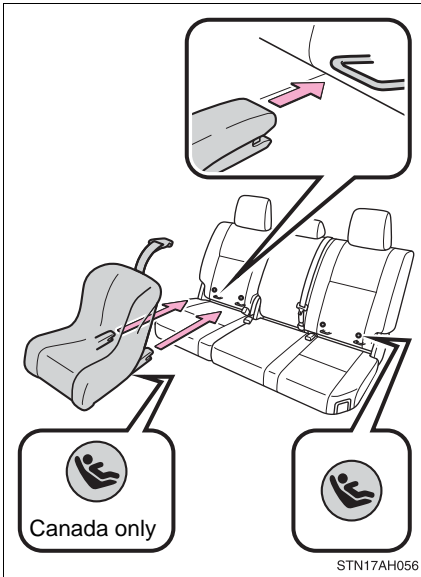

STEP 1 Widen the gap between the seat cushion and seatback slightly.

STEP 2 Latch the buckles onto the LATCH anchors.

STEP 3 If the child restraint has a top tether strap, the top tether strap should be latched onto the top tether strap anchor. (→P. 163)

For owners in Canada:
The symbol on a child restraint system indicates the presence of a lower connector system.

Installation with LATCH system (CrewMax models)

STEP 1 If the child restraint has a top tether strap, the top tether strap should be latched onto the top tether strap anchor. (→P. 167)

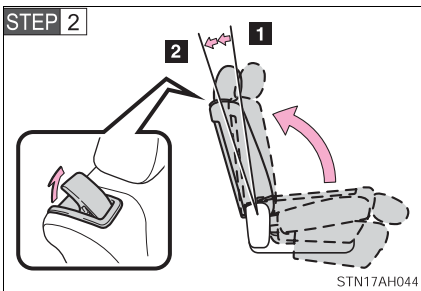

Fold down the seatback and back to the 1st lock position (most upright position) until it locks into place. Adjust the seatback to the 8th lock position. (→P. 65)

1 1st lock position

2 8th lock position

► Type A

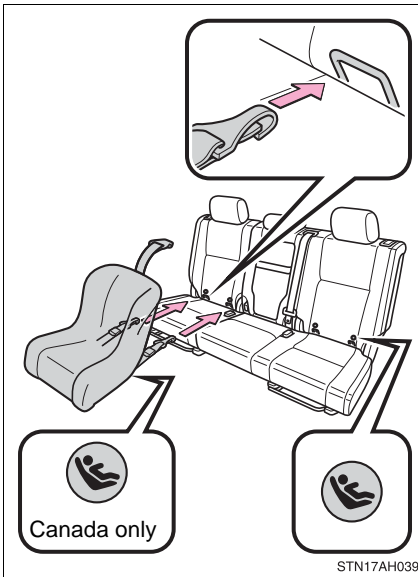

STEP 3 Widen the gap between the seat cushion and seatback slightly.

STEP 4 Latch the hooks of the lower straps onto the LATCH anchors and tighten the lower straps.

For owners in Canada:
The symbol on a child restraint system indicates the presence of a lower connector system.

► Type B

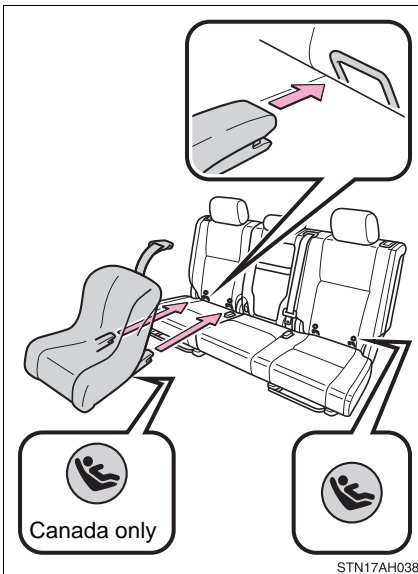

STEP 3 Widen the gap between the seat cushion and seatback slightly.

STEP 4 Latch the buckles onto the LATCH anchors.

For owners in Canada:
The symbol on a child restraint system indicates the presence of a lower connector system.

Installing child restraints using a seat belt (child restraint lock function belt)

■ **Rear-facing — Infant seat/convertible seat**

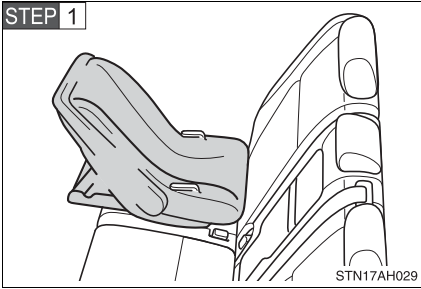

Place the child seat on the rear seat facing the rear of the vehicle.

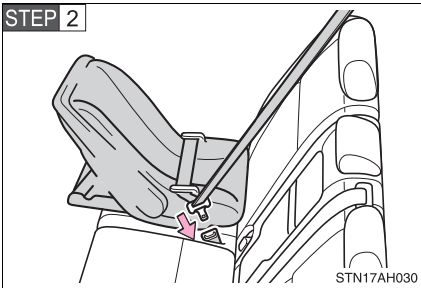

Run the seat belt through the child seat and insert the plate into the buckle. Make sure that the belt is not twisted.

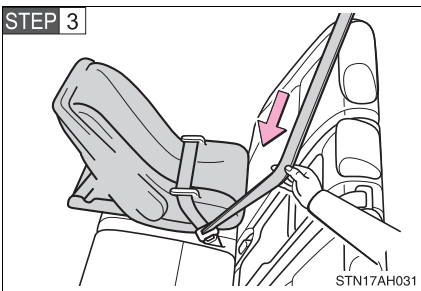

Fully extend the shoulder belt and then allow it to retract slightly in order to activate the ALR lock mode.

Lock mode allows the seat belt to retract only.

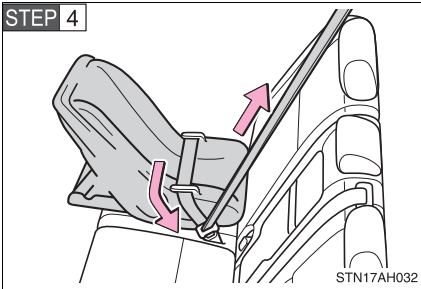

While pushing the child seat down into the rear seat, allow the shoulder belt to retract until the child seat is securely in place.

After the shoulder belt has retracted to a point where there is no slack in the belt, pull the belt to check that it cannot be extended.

■ Forward-facing — Convertible seat

STEP 1 CrewMax models: If the child restraint has a top tether strap, the top tether strap should be latched onto the top tether strap anchor. (→P. 167)

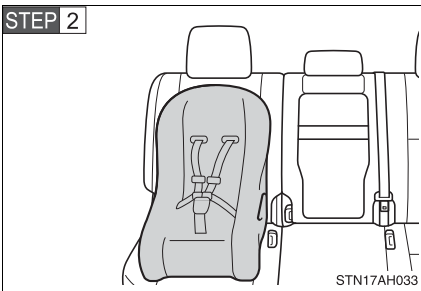

Place the child seat on the seat facing the front of the vehicle.

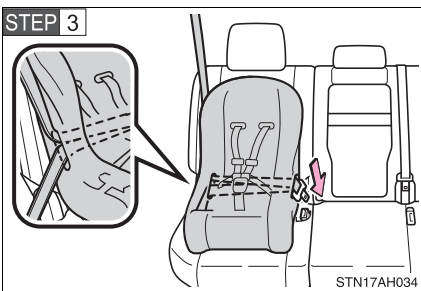

Run the seat belt through the child seat and insert the plate into the buckle. Make sure that the belt is not twisted.

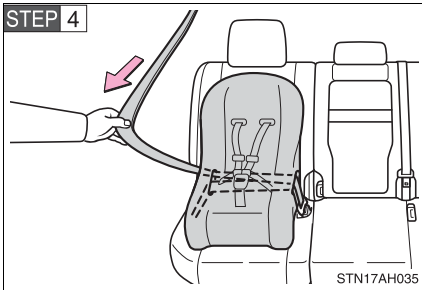

Fully extend the shoulder belt and then allow it to retract slightly in order to activate the ALR lock mode.

Lock mode allows the seat belt to retract only.

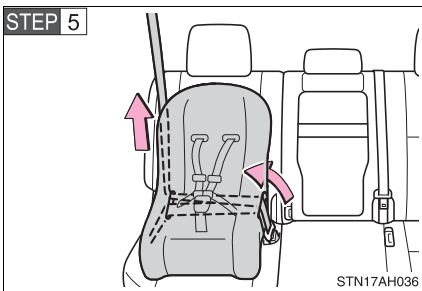

While pushing the child seat into the seat, allow the shoulder belt to retract until the child seat is securely in place.

After the shoulder belt has retracted to a point where there is no slack in the belt, pull the belt to check that it cannot be extended.

STEP 6 Regular Cab and Double Cab models: If the child restraint has a top tether strap, the top tether strap should be latched onto the top tether strap anchor.
(→P. 161, 163)

■ Booster seat

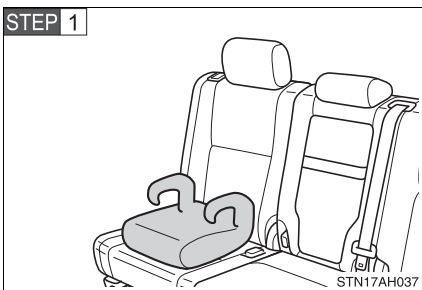

Place the booster seat on the seat facing the front of the vehicle.

STEP 2

Sit the child in the booster seat. Fit the seat belt to the booster seat according to the manufacturer's instructions and insert the plate into the buckle. Make sure that the belt is not twisted.

Check that the shoulder belt is correctly positioned over the child's shoulder, and that the lap belt is as low as possible. (→P. 77)

1

Before driving

Removing a child restraint installed with a seat belt

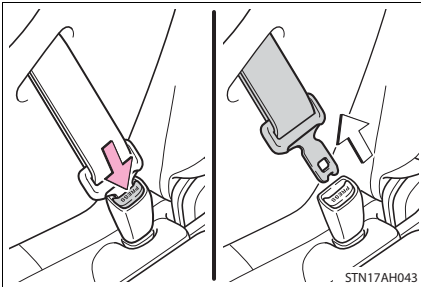

Push the buckle release button and fully retract the seat belt.

Child restraint systems with a top tether strap (Regular Cab models)

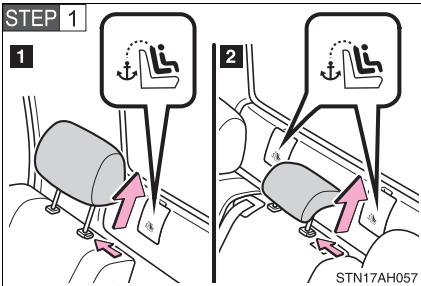
STEP 1

Remove the head restraint.

Installing position:

- 1** Right side passenger seat
- 2** Center passenger seat (Bench type seat)

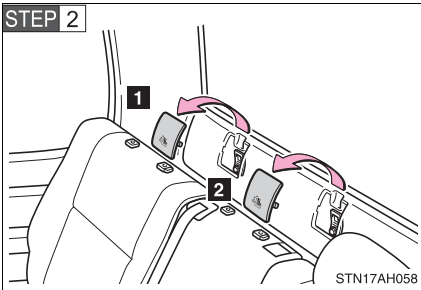

Remove the anchor bracket cover.

Installing position:

- 1 Right side passenger seat
- 2 Center passenger seat (Bench type seat)

Store the removed cover in a safe place such as the glove box.

► Right side passenger seat

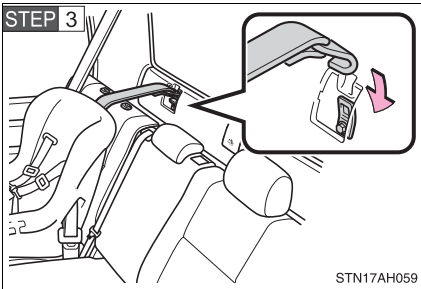

Latch the hook onto the anchor bracket and tighten the top tether strap.

Make sure the top tether strap is securely latched.

► Center passenger seat (bench type seat)

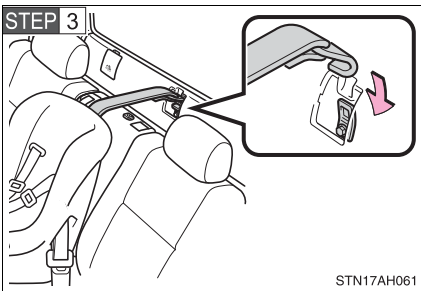

Latch the hook onto the anchor bracket and tighten the top tether strap.

Make sure the top tether strap is securely latched.

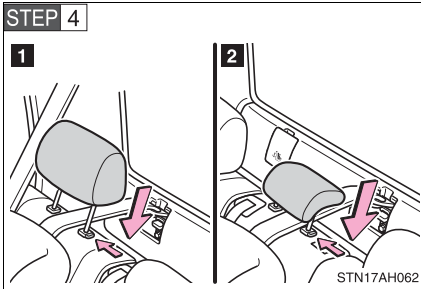

Replace the head restraint.

Installing position:

- 1 Right side passenger seat
- 2 Center passenger seat (Bench type seat)

Child restraint systems with a top tether strap (Double Cab models)

■ Right rear seat or center rear seat

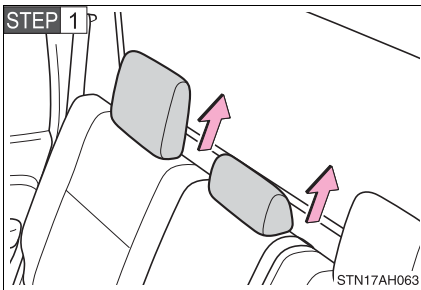

Raise the head restraints of right and center seats.

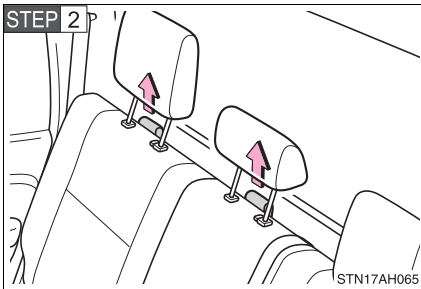

Pull up the straps of right and center seats.

► Right rear seat

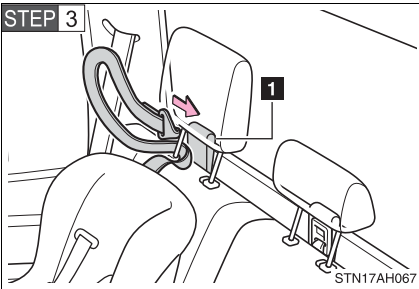

Route the top tether strap through the routing device as shown in the illustration.

Make sure the top tether strap is not twisted.

1 Routing device

► Center rear seat

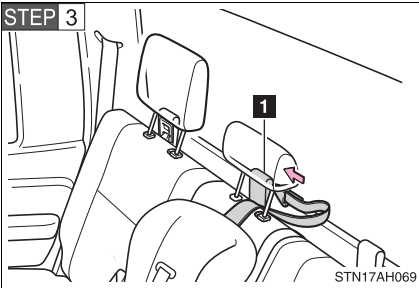

Route the top tether strap through the routing device as shown in the illustration.

Make sure the top tether strap is not twisted.

1 Routing device

► Right rear seat

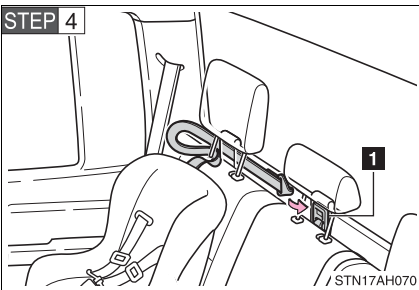

Latch the hook onto the inner anchor strap ring and tighten the top tether strap.

Make sure the top tether strap is securely latched.

1 Inner anchor strap ring

► Center rear seat

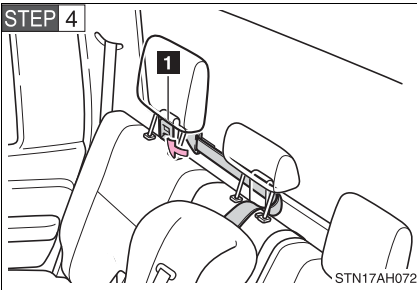

Latch the hook onto the inner anchor strap ring and tighten the top tether strap.

Make sure the top tether strap is securely latched.

1 Inner anchor strap ring

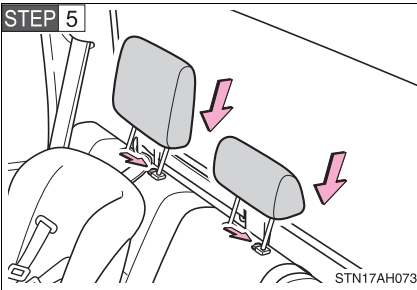

Lower the head restraints of right and center seats.

■ Left rear seat

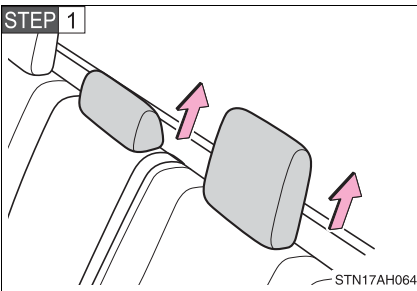

Raise the head restraints of center and left seats.

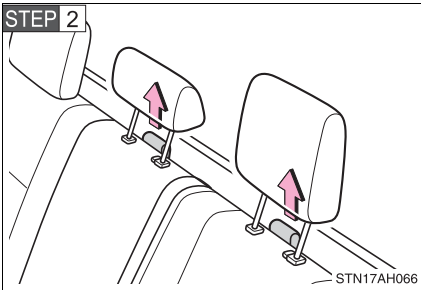

Pull up the straps of center and left seats.

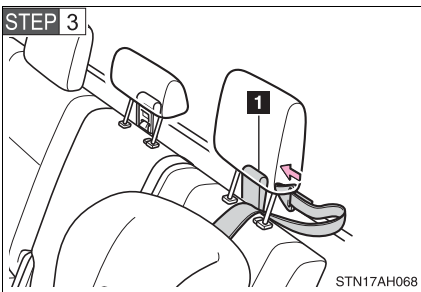

Route the top tether strap through the routing device as shown in the illustration.

Make sure the top tether strap is not twisted.

1 Routing device

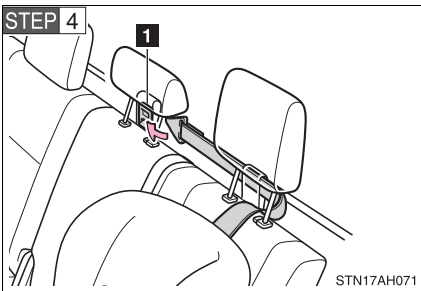

Latch the hook onto the inner anchor strap ring and tighten the top tether strap.

Make sure the top tether strap is securely latched.

1 Inner anchor strap ring

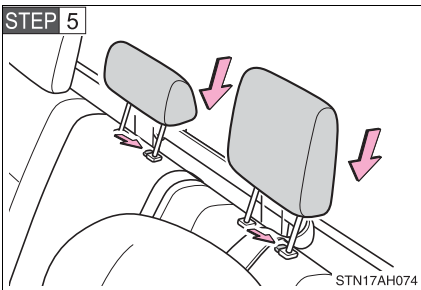

Lower the head restraints of center and left seats.

Child restraint systems with a top tether strap (CrewMax models)

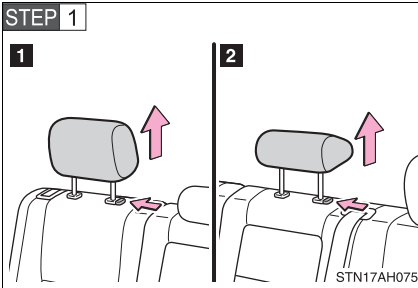

► Outside passenger seat

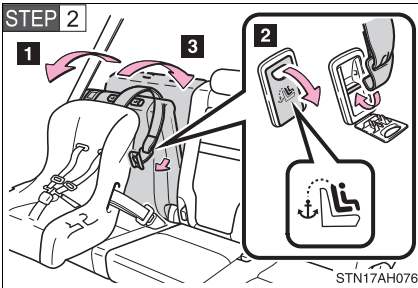

Remove the head restraint.

Installing position:

- 1 Outside passenger seat
- 2 Center passenger seat

- 1 Swing the seatback forward slightly. (→P. 65)
- 2 Open the anchor bracket cover.
Latch the hook onto the anchor bracket.
- 3 Return the seatback to its original position.

Make sure the seatback is securely locked by pushing forward and rearward on the top of the seatback.

► Center passenger seat

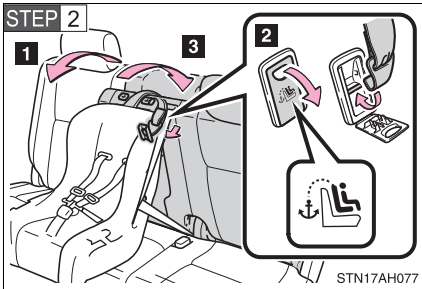

- 1** Swing the seatback forward slightly. (→P. 65)
- 2** Open the anchor bracket cover.
Latch the hook onto the anchor bracket.
- 3** Return the seatback to its original position.

Make sure the seatback is securely locked by pushing forward and rearward on the top of the seatback.

- STEP 3** Secure the child restraint using LATCH anchors (→P. 156) or a seat belt (→P. 159), and tighten the top tether strap.
Make sure the top tether strap is securely latched.

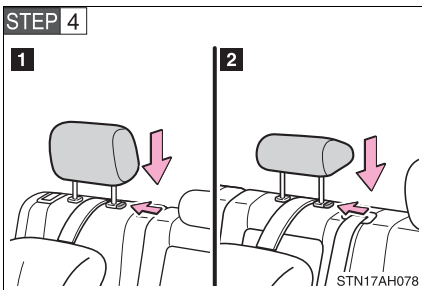

Replace the head restraint.

Installing position:

- 1** Outside passenger seat
- 2** Center passenger seat

■ Laws and regulations pertaining to anchorages

The LATCH system conforms to FMVSS225 or CMVSS210.2.

Child restraint systems conforming to FMVSS213 or CMVSS213 specifications can be used.

This vehicle is designed to conform to the SAE J1819.

⚠ CAUTION

■ When installing a booster seat

Do not fully extend the shoulder belt to prevent the belt from going to ALR lock mode. (→P. 81)

ALR mode causes the belt to tighten only which could cause injury or discomfort to the child.

■ When installing a child restraint system

Follow the directions given in the child restraint system installation manual and fix the child restraint system securely in place.

If the child restraint system is not correctly fixed in place, the child or other passengers may be seriously injured or even killed in the event of sudden braking, sudden swerving or an accident.

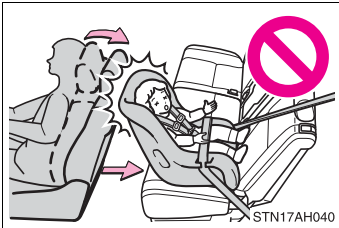

- Double Cab and CrewMax models: If the driver's seat interferes with the child restraint system and prevents it from being attached correctly, attach the child restraint system to the right-hand rear seat.

- Double Cab and CrewMax models: Adjust the front passenger seat so that it does not interfere with the child restraint system.

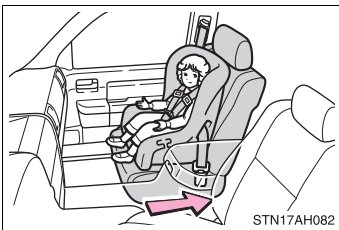

- Only put a forward-facing or booster child seat on the front seat when it is unavoidable. When installing a forward-facing or booster child seat on the front passenger seat, move the seat as far back as possible even if the AIR BAG OFF indicator light is illuminated. Failing to do so may result in death or serious injury if the airbags deploy (inflate).

! CAUTION

■ When installing a child restraint system

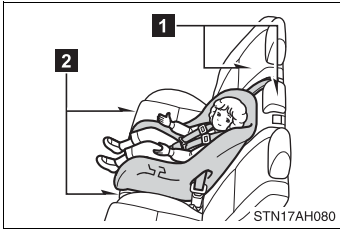

- Regular Cab models (bench type seat): In order to firmly secure the child restraint system, align the seatback angle and seat position of the right passenger seat to match the center passenger seat. Otherwise, it could cause death or injury in an accident.

1 Same angle

2 Same position

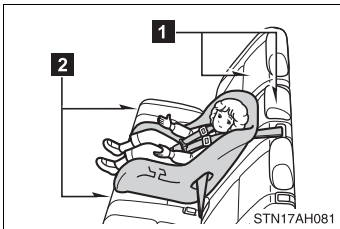

- CrewMax models: When installing a child restraint system in the rear center seat, adjust both seat cushions to the same position and align seatbacks at the same angle. Otherwise, the child restraint system cannot be securely restrained and this may cause death or serious injuries in the event of sudden braking, sudden swerving or an accident.

1 Same angle

2 Same position

- CrewMax models: When using the LATCH anchors for a child restraint system, move the seat as far back as possible and adjust the seatback as upright as possible.
- When a booster seat is installed, always ensure that the shoulder belt is positioned across the center of the child's shoulder. The belt should be kept away from the child's neck, but not so that it could fall off the child's shoulder. Failing to do so may result in death or serious injury in the event of sudden braking, sudden swerving or an accident.
- Ensure that the belt and tab are securely locked and the seat belt is not twisted.
- Push and pull the child seat from side to side and forward to be sure it is secure.

 **CAUTION****■ When installing a child restraint system**

- After securing a child restraint system, never adjust the seat.
- Follow all installation instructions provided by the child restraint system manufacturer.
- After securing the child restraint system, never slide or recline the seat.

■ Do not use a seat belt extender

If a seat belt extender is used when installing a child restraint system, the seat belt will not securely hold the child restraint system, which could cause death or serious injury to the child or other passengers in the event of sudden braking, sudden swerving or an accident.

■ To correctly attach a child restraint system to the anchors

When using the LATCH anchors, be sure that there are no foreign objects around the anchors and that the seat belt is not caught behind the child restraint. Make sure the child restraint system is securely attached, or it may cause death or serious injury to the child or other passengers in the event of a sudden stop, sudden swerve or accident.

2-1. Driving procedures

Driving the vehicle.....	174
Engine (ignition) switch....	183
Automatic transmission....	186
Turn signal lever	191
Parking brake.....	192
Horn	193

2-2. Instrument cluster

Gauges and meters	194
Indicators and warning lights	200
Multi-information display.....	204
Accessory meter	210

2-3. Operating the lights and wipers

Headlight switch.....	213
Fog light switch	217
Windshield wipers and washer	218

2-4. Using other driving systems

Cruise control.....	221
Intuitive parking assist.....	224
Rear view monitor system	230
Four-wheel drive system	236
AUTO LSD system.....	240
Driving assist systems	243

2-5. Driving information

Off-road precautions	250
Cargo and luggage	255
Vehicle load limits	258
Winter driving tips	260
Trailer towing	264
Dinghy towing	285

2-1. Driving procedures

Driving the vehicle

The following procedures should be observed to ensure safe driving.

■ Starting the engine (→P. 183)

■ Driving

STEP 1 With the brake pedal depressed, shift the shift lever to D. (→P. 186)

STEP 2 Release the parking brake. (→P. 192)

STEP 3 Gradually release the brake pedal and gently depress the accelerator pedal to accelerate the vehicle.

■ Stopping

STEP 1 With the shift lever in D, depress the brake pedal.

STEP 2 If necessary, set the parking brake.

When the vehicle is stopped for an extended period of time, shift the shift lever to P or N. (→P. 186)

■ Parking the vehicle

STEP 1 With the shift lever in D, depress the brake pedal.

STEP 2 Set the parking brake. (→P. 192)

STEP 3 Shift the shift lever to P. (→P. 186)

When parking on a hill, if necessary, block the wheels.

STEP 4 Turn the engine switch off to stop the engine.

STEP 5 Lock the door, making sure that you have the key on your person.

Starting on a steep uphill

- STEP 1** With the brake pedal depressed, firmly set the parking brake and shift the shift lever to D.
- STEP 2** Gently depress the accelerator pedal.
- STEP 3** Release the parking brake.

■ Driving in the rain

- Drive carefully when it is raining, because visibility will be reduced, the windows may become fogged-up, and the road will be slippery.
- Drive carefully when it starts to rain, because the road surface will be especially slippery.
- Refrain from high speeds when driving on an expressway in the rain, because there may be a layer of water between the tires and the road surface, preventing the steering and brakes from operating properly.

■ Breaking in your new Toyota

To extend the life of the vehicle, the following precautions are recommended to observe:

- For the first 200 miles (300 km):
Avoid sudden stops.
- For the first 500 miles (800 km):
Do not tow a trailer.
- For the first 1000 miles (1600 km):
 - Do not drive at extremely high speeds.
 - Avoid sudden acceleration.
 - Do not drive continuously in the low gears.
 - Do not drive at a constant speed for extended periods.

■ Drum-in disc type parking brake system

Your vehicle has a drum-in-disc type parking brake system. This type of brake system needs bedding-down of the brake shoes periodically or whenever the parking brake shoes and/or drum are replaced. Have your Toyota dealer perform the bedding down.

■ Operating your vehicle in a foreign country

Comply with the relevant vehicle registration laws and confirm the availability of the correct fuel. (→P. 656)

CAUTION

■ When starting the vehicle

Always keep your foot on the brake pedal while stopped with the engine running. This prevents the vehicle from creeping.

■ When driving the vehicle

- Do not drive if you are unfamiliar with the location of the brake and accelerator pedals to avoid depressing the wrong pedal.
 - Accidentally depressing the accelerator pedal instead of the brake pedal will result in sudden acceleration that may lead to an accident that could result in death or serious injury.
 - When backing up, you may twist your body around, leading to a difficulty in operating the pedals. Make sure to operate the pedals properly.
 - Make sure to keep a correct driving posture even when moving the vehicle only slightly, allowing you to depress the brake and accelerator pedals properly.
 - Depress the brake pedal using your right foot. Depressing the brake pedal using your left foot may delay response in an emergency, resulting in an accident.
- Do not drive the vehicle over or stop the vehicle near flammable materials. The exhaust system and exhaust gases can be extremely hot. This may cause a fire if there is any flammable material nearby.
- Do not let the vehicle roll backwards while the shift lever is in a driving position, or roll forward while the shift lever is in R. Doing so may cause the engine to stall or lead to poor brake and steering performance, resulting in an accident or damage to the vehicle.
- If the smell of exhaust is noticed inside the vehicle, open the windows and check that the back window is closed. Large amounts of exhaust in the vehicle can cause driver drowsiness and an accident, resulting in death or a serious health hazard. Have the vehicle inspected by your Toyota dealer immediately.

 CAUTION

■ When driving the vehicle

- Do not shift the shift lever to P while the vehicle is moving.
Doing so can damage the transmission and may result in a loss of vehicle control.
- Do not shift the shift lever to R while the vehicle is moving forward.
Doing so can damage the transmission and may result in a loss of vehicle control.
- Do not shift the shift lever to D while the vehicle is moving backward.
Doing so can damage the transmission and may result in a loss of vehicle control.
- Moving the shift lever to N while the vehicle is moving will disengage the engine from the transmission. Engine braking is not available when N is selected.
- During normal driving, do not turn off the engine. Turning the engine off while driving will not cause loss of steering or braking control, but the power assist to these systems will be lost. This will make it more difficult to steer and brake, so you should pull over and stop the vehicle as soon as it is safe to do so.
However, in the event of an emergency, such as if it becomes impossible to stop the vehicle in the normal way: →P. 595
- Use engine braking (downshift) to maintain a safe speed when driving down a steep hill.
Using the brakes continuously may cause the brakes to overheat and lose effectiveness. (→P. 186)
- When stopped on an inclined surface, use the brake pedal and parking brake to prevent the vehicle from rolling backward or forward and causing an accident.
- Do not adjust the position of the steering wheel, the seat, or the inside or outside rear view mirrors while driving.
Doing so may result in a loss of vehicle control that can cause accidents that may result in death or serious injury.
- Always check that all passengers' arms, heads or other parts of their bodies are not outside the vehicle, as this may result in death or serious injury.

 **CAUTION**

- Do not drive in excess of the speed limit. Even if the legal speed limit permits it, do not drive over 85 mph (140 km/h) unless your vehicle has high-speed capability tires. Driving over 85 mph (140 km/h) may result in tire failure, loss of control and possible injury. Be sure to consult a tire dealer to determine whether the tires on your vehicle are high-speed capability tires or not before driving at such speeds.

■ **When driving on slippery road surfaces**

- Sudden braking, acceleration and steering may cause tire slippage and reduce your ability to control the vehicle, resulting in an accident.
- Sudden changes in engine speed, such as engine braking caused by up-shifting or down-shifting, may cause the vehicle to skid, resulting in an accident.
- After driving through a puddle, lightly depress the brake pedal to make sure that the brakes are functioning properly. Wet brake pads may prevent the brakes from functioning properly. If the brakes on only one side are wet and not functioning properly, steering control may be affected, resulting in an accident.

■ **When shifting the shift lever**

Be careful not to shift the shift lever with the accelerator pedal depressed. This may lead to unexpected rapid acceleration of the vehicle that may cause an accident and result in death or serious injury.

■ **When the vehicle is stopped**

- Do not race the engine.
If the vehicle is in any gear other than P or N, the vehicle may accelerate suddenly and unexpectedly, and may cause an accident.
- Do not leave the vehicle with the engine running for a long time.
If such a situation cannot be avoided, park the vehicle in an open space and check that exhaust fumes do not enter the vehicle interior.
- In order to prevent accidents due to the vehicle rolling away, always keep depressing the brake pedal while the engine is running, and apply the parking brake as necessary.
- If the vehicle is stopped on an incline, in order to prevent accidents caused by the vehicle rolling forward or backward, always depress the brake pedal and securely apply the parking brake as needed.

 **CAUTION**

- Avoid revving or racing the engine.

Running the engine at high speed while the vehicle is stopped may cause the exhaust system to overheat, which could result in a fire if combustible material is nearby.

■ **When the vehicle is parked**

- Do not leave glasses, cigarette lighters, spray cans, or soft drink cans in the vehicle when it is in the sun.

Doing so may result in the following.

- Gas may leak from a cigarette lighter or spray can, and may lead to a fire.
- The temperature inside the vehicle may cause the plastic lenses and plastic material of eye glasses to deform or crack.
- Soft drink cans may fracture, causing the contents to spray over the interior of the vehicle, and may also cause a short circuit in the vehicle's electrical components.

- Always apply the parking brake, shift the shift lever to P, stop the engine and lock the vehicle.

Do not leave the vehicle unattended while the engine is running.

- If the shift lever is moved before the 4LO indicator turns on/off, the transfer mode may not be shifted completely. The transfer mode disengages both the front and rear driveshafts from the powertrain and allows the vehicle to move regardless of the shift position. (At this time, the indicator blinks and the buzzer sounds.)

Therefore, the vehicle is free to roll even if the automatic transmission is in P. You or someone else could be seriously injured. You must complete the shifting of the transfer mode. (→P. 238)

- Do not touch the exhaust pipe while the engine is running or immediately after turning the engine off.

Doing so may cause burns.

- Do not leave the engine running in an area with snow build-up, or where it is snowing. If snowbanks build up around the vehicle while the engine is running, exhaust gases may collect and enter the vehicle. This may lead to death or a serious health hazard.

 **CAUTION**

■ **Exhaust gases**

Exhaust gases include harmful carbon monoxide (CO) that is colorless and odorless. Inhaling exhaust gases may lead to death or a serious health hazard.

- If the vehicle is in a poorly ventilated area, stop the engine. In a closed area, such as a garage, exhaust gases may collect and enter the vehicle. This may lead to death or a serious health hazard.
- The exhaust should be checked occasionally. If there is a hole or crack caused by corrosion, damage to a joint or abnormal exhaust noise, be sure to have the vehicle inspected and repaired by your Toyota dealer. Failure to do so may allow exhaust gases to enter the vehicle, resulting in death or a serious health hazard.
- Toyota does not recommend occupying the rear cargo area when it is fitted with a slide-in camper, camper shell or other type cover while the engine is running. This caution applies to both driving and stopped or parked situations with the engine running. Particular care should be taken to prevent exhaust gases from entering camper bodies, trailers or other enclosures on or around your vehicle. If exhaust fumes are detected, open all windows and thoroughly ventilate the area.

■ **When taking a nap in the vehicle**

Always turn the engine off. Otherwise, you may accidentally move the shift lever or depress the accelerator pedal, which could cause an accident or fire due to engine overheating. Additionally, if the vehicle is parked in a poorly ventilated area, exhaust gases may collect and enter the vehicle, leading to death or a serious health hazard.

■ **When braking the vehicle**

- When the brakes are wet, drive more cautiously.
Braking distance increases when the brakes are wet, and may cause one side of the vehicle to brake differently than the other side. Also the parking brake may not securely hold the vehicle.

 **CAUTION**
■ When braking the vehicle

- If the power brake assist function does not operate, do not follow other vehicles closely and avoid downhills or sharp turns that require braking. In this case, braking is still possible, but it will require more force on the pedal than usual. Braking distance may also increase.
- Do not pump the brake pedal if the engine stalls.
Each push on the brake pedal uses up the reserve for the power-assisted brakes.
- The brake system consists of 2 individual hydraulic systems: If one of the systems fails, the other will still operate. In this case, the brake pedal should be depressed more firmly than usual and braking distance becomes longer.
Do not drive your vehicle with only a single brake system. Have your brakes fixed immediately.

 **NOTICE**
■ When driving the vehicle

Do not use the accelerator pedal or depress accelerator and brake pedals together to hold the vehicle on a hill.

■ When parking the vehicle

Always put the shift lever in P.

Failure to do so may cause the vehicle to move or the vehicle may accelerate suddenly if the accelerator pedal is accidentally depressed.

■ Avoiding damage to vehicle parts

- Do not turn the steering wheel fully in either direction and hold it there for a long time.
Doing so may damage the power steering pump.
- When driving over bumps in the road, drive as slowly as possible to avoid damaging the wheels, underside of the vehicle, etc.

 NOTICE

■ If you hear a squealing or scraping noise while driving (brake pad wear limit indicators)

Have the brake pads checked and replaced by your Toyota dealer as soon as possible.

The rotor damage can result if the pads are not replaced when needed.

It is dangerous to drive the vehicle when the wear limits of the brake pads and/or that of the brake discs are exceeded.

■ If you get a flat tire while driving

A flat or damaged tire may cause the following situations. Hold the steering wheel firmly and gradually press the brake pedal to slow down the vehicle.

- It may be difficult to control your vehicle.
- The vehicle will make abnormal sounds.
- The vehicle will behave abnormally.

Replace a flat tire with a new one. (→P. 608)

■ When encountering flooded roads

Do not drive on a road that has flooded after heavy rain etc. Doing so may cause the following serious damage to the vehicle.

- Engine stalling
- Short in electrical components
- Engine damage caused by water immersion

In the event that you drive on a flooded road and the vehicle is flooded, be sure to have your Toyota dealer check the following.

- Brake function
- Changes in quantity and quality of oil and fluid used for the engine, transmission, transfer (4WD models), differentials, etc.
- Lubricant condition for the propeller shaft, bearings and suspension joints (where possible) and the function of all joints, bearings, etc.

2-1. Driving procedures

Engine (ignition) switch

■ Engine switch

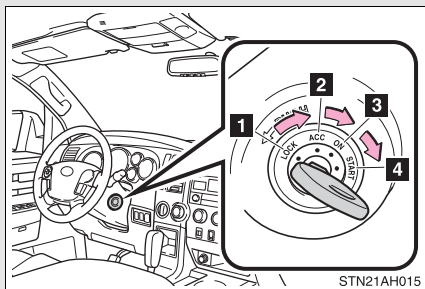

1 LOCK

The steering wheel is locked and the key can be removed. (The key can be removed only when the shift lever is in P.)

2 ACC

Some electrical components such as the audio system can be used.

3 ON

All electrical components can be used.

4 START

For starting the engine.

■ Starting the engine

STEP 1 Check that the parking brake is set.

STEP 2 Check that the shift lever is set in P.

STEP 3 Sit in the driver's seat and firmly depress the brake pedal.

STEP 4 Turn the engine switch to the START position and start the engine.

The engine will crank until it starts or for up to 25 seconds, whichever is less. If you turn the engine switch, the engine will keep cranking for about 30 seconds maximum.

Continue depressing the brake pedal until the engine is completely started.

■ Turning the key from ACC to LOCK

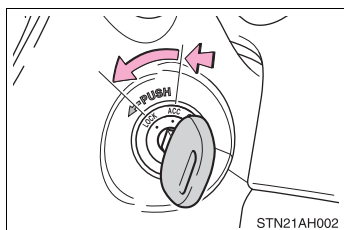

STEP 1 Shift the shift lever to P.
(→P. 186)

STEP 2 Push in the key and turn to the LOCK position.

■ Steering lock release

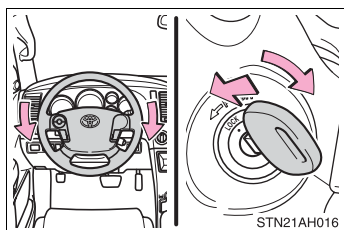

When starting the engine, the engine switch may seem stuck in the LOCK position. To free it, turn the key while turning the steering wheel slightly in either direction.

■ If the engine does not start (vehicles with engine immobilizer system)

The engine immobilizer system may not have been deactivated. (→P. 114)

■ Key reminder function

A buzzer sounds if the driver's door is opened, while the engine switch is in the ACC or LOCK position to remind you to remove the key.

 CAUTION**■ When starting the engine**

Always start the engine while sitting in the driver's seat. Do not depress the accelerator while starting the engine under any circumstances.

Doing so may cause an accident resulting in death or serious injury.

■ Stopping the engine in an emergency

If you want to stop the engine in an emergency while driving the vehicle, push and hold the engine switch for more than 3 seconds. However, do not touch the engine switch while driving except in an emergency. If the engine stops while the vehicle is being driven, this could lead to an unexpected accident.

 NOTICE**■ To prevent battery discharge**

Do not leave the engine switch in the ACC or ON position for long periods if the engine is not running.

■ When starting the engine

- Do not crank for more than 30 seconds at a time. This may overheat the starter and wiring systems.
- Do not race a cold engine.
- If the engine becomes difficult to start or stalls frequently, have the engine checked immediately.

2-1. Driving procedures

Automatic transmission

Select a shift position appropriate for the driving conditions.

■ Shifting the shift lever

▶ Floor shift type

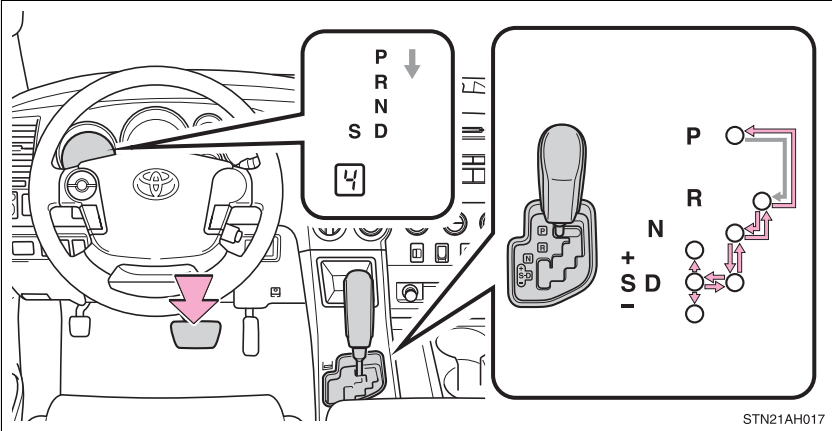

← While the engine switch is on, depress the brake pedal and move the shift lever.

▶ Column-shift type

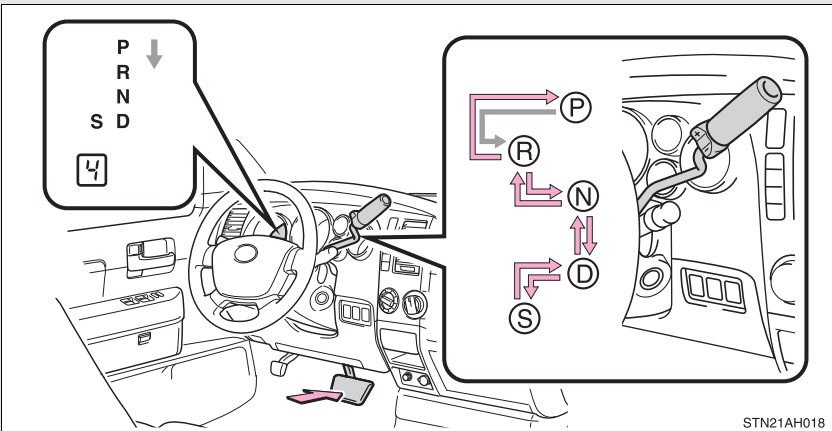

← While the engine switch is on, depress the brake pedal and move the shift lever.

■ Shift position uses

Shift position	Function
P	Parking the vehicle or starting the engine
R	Reversing
N	Neutral
D	Normal driving ^{*1}
S	S mode driving ^{*2}

*1: To improve fuel consumption and reduce noises, set the shift lever in D for normal driving.

*2: Selecting shift ranges S mode restricts the upper limit of the possible gear ranges, control engine braking forces, and prevents unnecessary upshifting.

Changing shift ranges in S mode

Shift the shift lever to the S position and operate the shift lever.

► Floor shift type

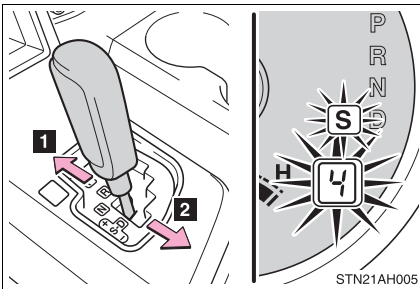

- 1 Upshifting
- 2 Downshifting

▶ Column-shift type

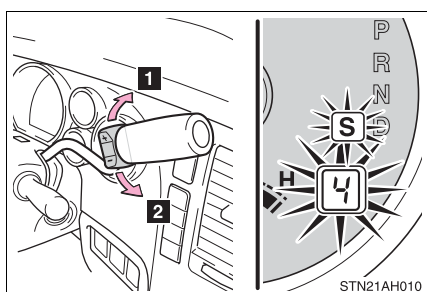

1 Upshifting

2 Downshifting

The initial shift range in S mode is automatically set to 5 or 4 (6-speed models) or 4 (5-speed models) according to vehicle speed. However, the initial shift range may be set to 3 or 2 (6-speed models) or 3 (5-speed models) if the AI-SHIFT has operated while the shift lever was in the D position. (→P. 190)

■ Shift ranges and their functions

Shift range	Function	
	6-speed models	5-speed models
6	Automatically selecting gears between 1 and 6 according to vehicle speed and driving conditions.	—
5	Automatically selecting gears between 1 and 5 according to vehicle speed and driving conditions.	
4	Automatically selecting gears between 1 and 4 according to vehicle speed and driving conditions.	
3	Automatically selecting gears between 1 and 3 according to vehicle speed and driving conditions.	
2	Automatically selecting gears between 1 and 2 according to vehicle speed and driving conditions.	
1	Setting the gear at 1.	

A lower shift range will provide greater engine braking forces than a higher shift range.

TOW/HAUL switch (6-speed models with towing package)

Use TOW/HAUL mode when pulling a trailer or hauling a heavy load.

► Floor shift type

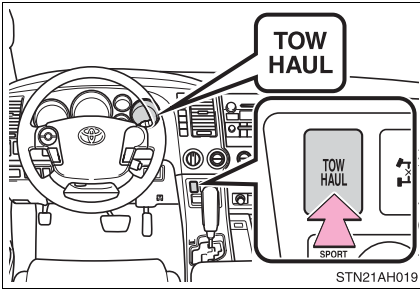

Press the TOW/HAUL switch. The indicator will come on.

Press the switch once more to cancel the mode.

► Column-shift type

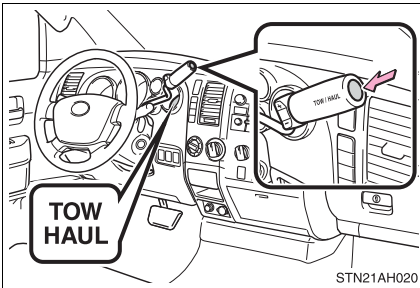

■ **Gear range display when driving in S mode**

The current gear range is displayed on the combination meter. (→P. 187)

■ **When driving with the cruise control system (if equipped)**

The engine brake will not operate in the S mode, even when downshifting to 5 or 4 (6-speed models) or 4 or 3 (5-speed models). (→P. 221)

■ **If the shift lever cannot be shifted from P**

→P. 627

■ **If the S indicator does not come on even after shifting the shift lever to S**

This may indicate a malfunction in the automatic transmission system. Have the vehicle inspected by your Toyota dealer, immediately.

(In this situation, the vehicle will operate as if the shift lever is in D.)

■ **AI-SHIFT**

The AI-SHIFT automatically shifts the gear to the optimal position according to the driver performance and driving conditions.

The AI-SHIFT automatically operates when the shift lever is in the D position. (Shifting the shift lever to the S position cancels the function.)

■ **Downshifting restrictions warning buzzer (in the S mode)**

To help ensure safety and driving performance, downshifting operation may sometimes be restricted. In some circumstances, downshifting may not be possible even when the shift lever is operated. (The warning buzzer will sound twice.)

2-1. Driving procedures

Turn signal lever

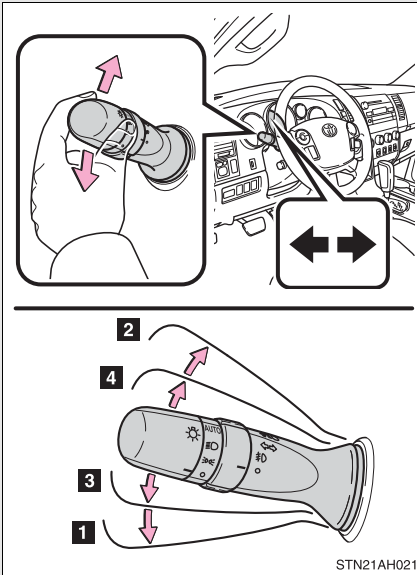

1 Left turn

2 Right turn

3 Move and hold the lever partway to signal a lane change.

The left hand signal will flash until you release the lever.

4 Move and hold the lever partway to signal a lane change.

The right hand signal will flash until you release the lever.

2

When driving

■ Turn signals can be operated when

The engine switch is in the ON position.

■ If the indicators flash faster than usual

Check that a light bulb in the front or rear turn signal lights has not burned out.

Parking brake

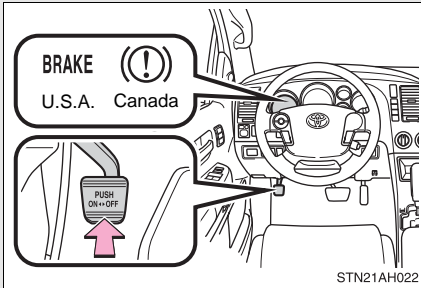

Sets the parking brake*.
(Depressing the pedal again releases the parking brake.)

At this time, the indicator will come on.

*: Fully depress the parking brake pedal with your left foot while depressing the brake pedal with your right foot.

■ Parking brake engaged warning buzzer

The buzzer sounds to indicate that parking brake is still engaged (with the vehicle having reached a speed of 3 mph [5 km/h]).

■ Usage in winter time

See “Winter driving tips” for parking brake usage in winter time. (→P. 260)

⚠ NOTICE

■ Before driving

Fully release the parking brake.

Driving the vehicle with the parking brake set will lead to brake components overheating, which may affect braking performance and increase brake wear.

Horn

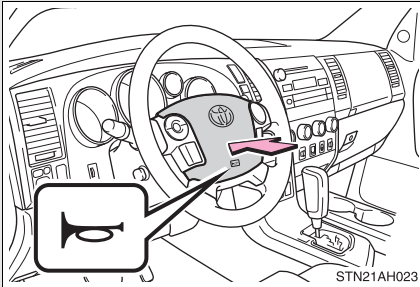

To sound the horn, press on or close to the  mark.

■ **After adjusting the steering wheel (manually adjustable type)**

Make sure that the steering wheel is securely locked.

The horn may not sound if the steering wheel is not securely locked.

(→P. 85)

2-2. Instrument cluster

Gauges and meters

► Vehicles with multi-information display

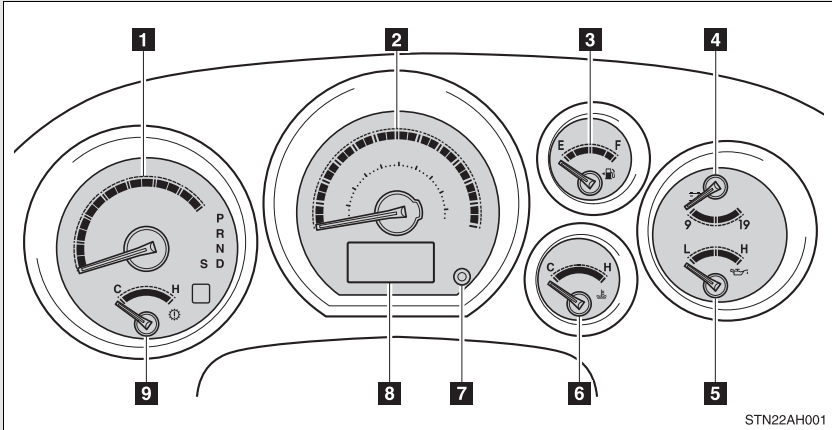

STN22AH001

The following gauges, meters and displays illuminate when the engine switch is in the ON position.

1 Tachometer

Displays the engine speed in revolutions per minute.

2 Speedometer

Displays the vehicle speed.

3 Fuel gauge

Displays the quantity of fuel remaining in the tank.

4 Voltmeter

Displays the charge state.

5 Engine oil pressure gauge

Displays the engine oil pressure.

6 Engine coolant temperature gauge

Displays the engine coolant temperature.

7 Odometer/trip meter switching and trip meter resetting button

Switches between odometer and trip meter displays. Pushing and holding the button will reset the trip meter when the trip meter is being displayed.

8 Multi-information display

→P. 204

9 Automatic transmission fluid temperature gauge

Displays the automatic transmission fluid temperature.

► Vehicles without multi-information display (type A)

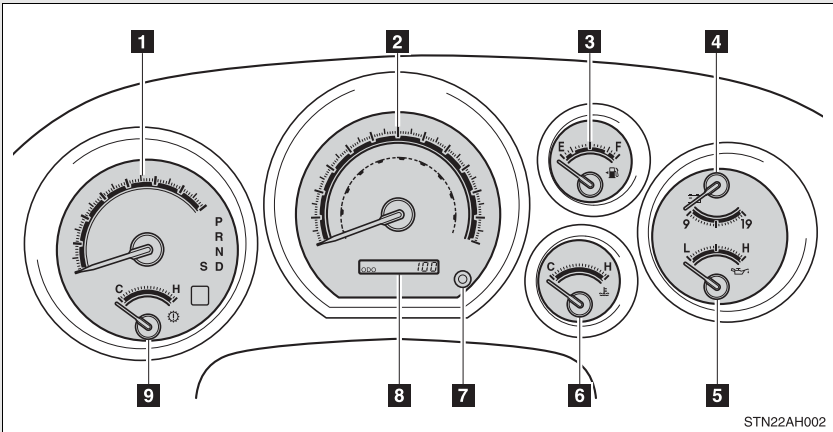

► Vehicles without multi-information display (type B)

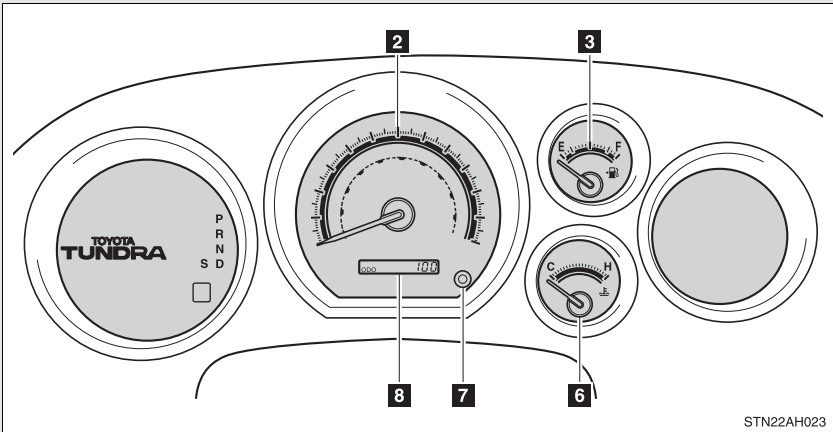

The following gauges, meters and displays illuminate when the engine switch is in the ON position.

1 Tachometer (if equipped)

Displays the engine speed in revolutions per minute.

2 Speedometer

Displays the vehicle speed.

3 Fuel gauge

Displays the quantity of fuel remaining in the tank.

4 Voltmeter (if equipped)

Displays the charge state.

5 Engine oil pressure gauge (if equipped)

Displays the engine oil pressure.

6 Engine coolant temperature gauge

Displays the engine coolant temperature.

7 Odometer/trip meter switching and trip meter resetting button

Switches between odometer and trip meter displays. Pushing and holding the button will reset the trip meter when the trip meter is being displayed.

8 Odometer/trip meter

Odometer:

Displays the total distance the vehicle has been driven.

Trip meter:

Displays the distance the vehicle has been driven since the meter was last reset. Trip meters A and B can be used to record and display different distances independently.

9 Automatic transmission fluid temperature gauge (if equipped)

Displays the automatic transmission fluid temperature.

Odometer and trip meter display button

Pressing this button switches between odometer and trip meter displays.

► Vehicles with multi-information display

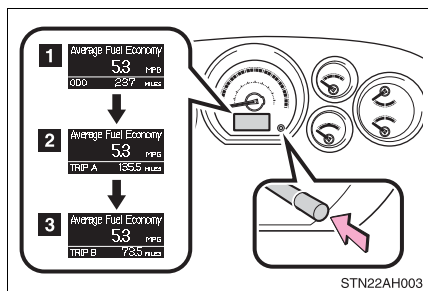

1 Odometer

2 Trip meter A *

3 Trip meter B *

*:Pushing and holding the button will reset the trip meter.

► Vehicles without multi-information display

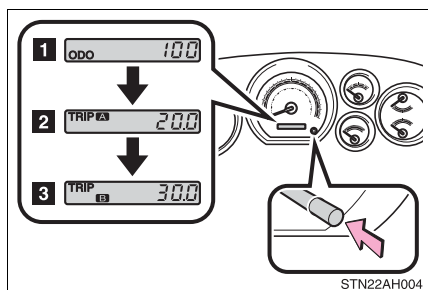

1 Odometer

2 Trip meter A *

3 Trip meter B *

*:Pushing and holding the button will reset the trip meter.

Instrument panel light control

The brightness of the instrument panel lights can be adjusted.

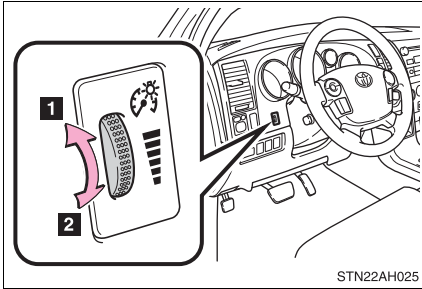

1 Brighter

2 Darker

► Vehicles with multi-information display

With the dial turned fully up, the intensity of the instrument panel lights will not be reduced even when the tail lights/headlights are turned on.

NOTICE

■ To prevent damage to the engine and its components

- Do not let the indicator needle of the tachometer enter the red zone, which indicates the maximum engine speed.
- The engine may be overheating if the engine coolant temperature gauge is in the red zone (H). In this case, immediately stop the vehicle in a safe place, and check the engine after it has cooled completely. (→P. 634)

■ While driving

- When the voltmeter indicates more than 19 V or less than 9 V, the battery may be malfunctioning. Have your vehicle checked at your Toyota dealer.
- When the engine oil pressure gauge does not work properly, immediately stop the engine and contact your Toyota dealer.
- When the automatic transmission fluid temperature gauge needle continually points higher than normal, immediately contact your Toyota dealer. (if equipped)

Indicators and warning lights

The indicator and warning lights on the instrument cluster and center panel inform the driver of the status of the vehicle's various systems.

■ Instrument cluster

► Vehicles with multi-information display

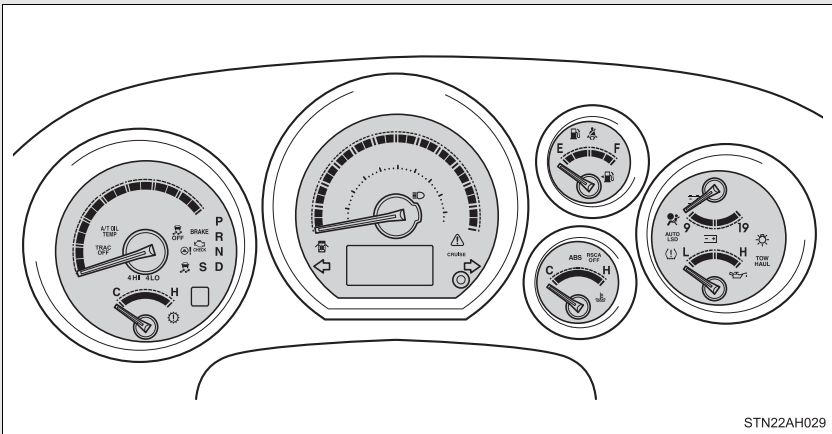

► Vehicles without multi-information display (type A)

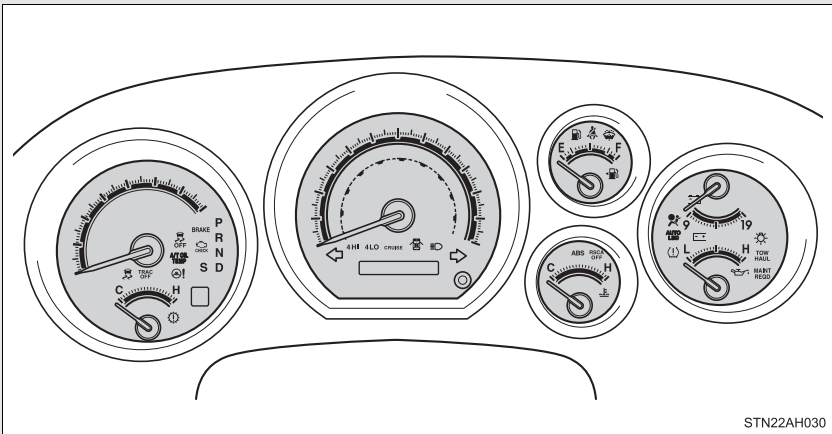

▶ Vehicles without multi-information display (type B)

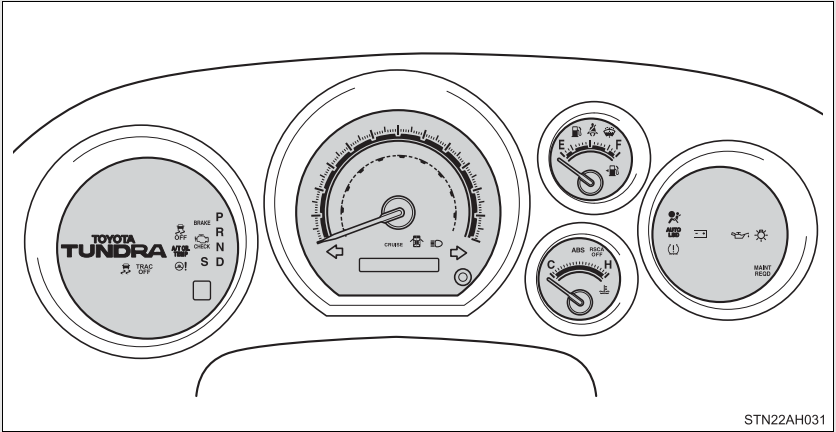

STN22AH031

■ Center panel

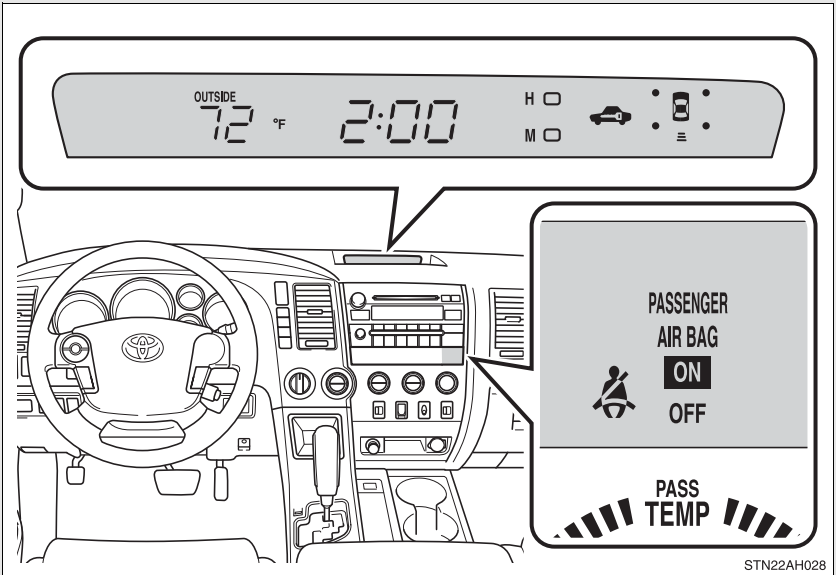

STN22AH028

■ Indicators

The indicators inform the driver of the operating state of the vehicle's various systems.



Turn signal indicator
(→P. 191)



(Canada)

Tail light indicator
(→P. 213)



Headlight high beam indicator (→P. 213)



*1

AUTO LSD indicator
(→P. 240, 245)



(If equipped)

Security indicator
(→P. 114)



*1,7

RSCA OFF indicator
(→P. 134)

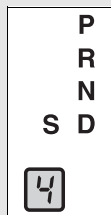

Shift position and shift range indicators
(→P. 186)



TRAC OFF indicator
(→P. 245, 246, 247)



*1

AIR BAG ON indicator
(→P. 136)



*1

AIR BAG OFF indicator
(→P. 136)



(If equipped)

Cruise control indicator
(→P. 221)



(4WD models)

4HI indicator (→P. 236)



*1,5

Slip indicator
(→ P. 241, 244)



(4WD models)

4LO indicator (→P. 236)



*1

VSC OFF indicator
(→P. 240, 245, 246, 247)



(If equipped)

TOW HAUL indicator
(→P. 189)



(U.S.A.)

Headlight indicator
(→P. 213)

■ Warning lights

Warning lights inform the driver of malfunctions in any of the vehicle's systems. (→P. 595)

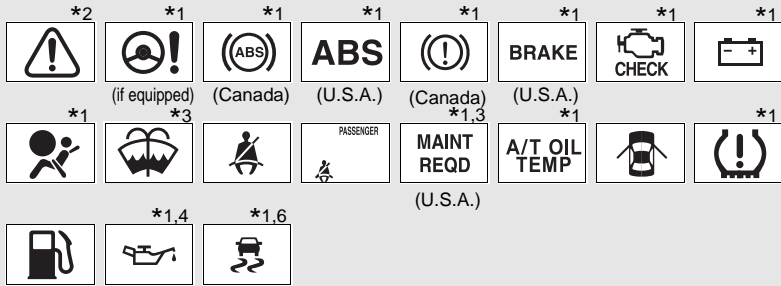

*1: These lights turn on when the engine switch is turned to the ON position to indicate that a system check is being performed. They will turn off after the engine is started, or after a few seconds. There may be a malfunction in a system if a light does not come on, or if the lights do not turn off. Have the vehicle inspected by your Toyota dealer for details.

*2: Vehicles with multi-information display

*3: Vehicles without multi-information display

*4: Vehicles without tachometer

*5: The indicator flashes to indicate that the system is operating.

*6: The indicator comes on to indicate a malfunction.

*7: For 2WD models, even though there is no function of deactivating the curtain shield airbags in a vehicle rollover, the RSCA OFF indicator turns on briefly when the engine switch is turned to the ON position. But this is not a malfunction.

▲ CAUTION

■ If a safety system warning light does not come on

Should a safety system light such as ABS and the SRS airbag warning light not come on when you start the engine, this could mean that these systems are not available to help protect you in an accident, which could result in death or serious injury. Have the vehicle inspected by your Toyota dealer immediately if this occurs.

Multi-information display*

The multi-information display presents the driver with a variety of driving-related data.

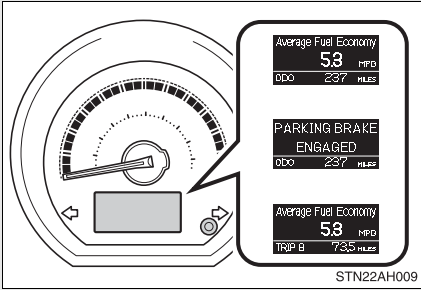

- Trip information

Displays driving range, fuel consumption and other cruising-related information.

- Warning messages

(→P. 604)

Automatically displayed when a malfunction occurs in one of the vehicle's systems.

- Odometer and trip meter display

(→P. 198)

Trip information

Display items can be switched by pushing the INFO button.

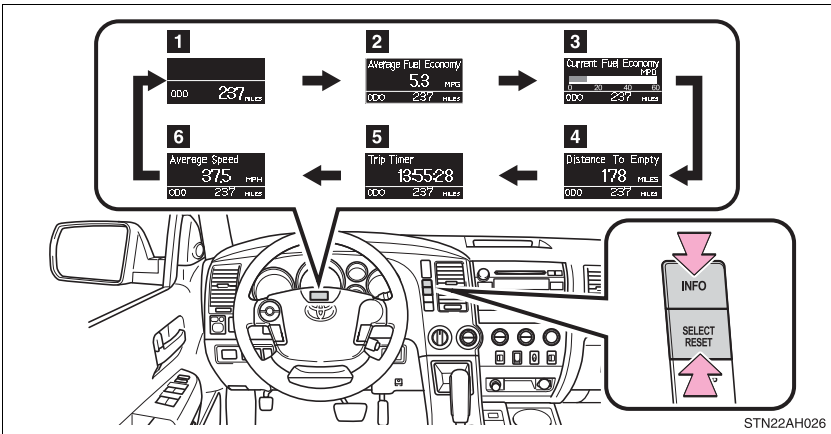

*: If equipped

1 Zoom display of odometer and trip meters

Displays the odometer and one of the trip meters simultaneously.

2 Average Fuel Economy

Displays the average fuel consumption since the function was reset.

The function can be reset by pushing the SELECT RESET button for more than 2 seconds.

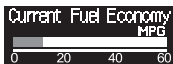
3 Current Fuel Economy

Displays the current rate of fuel consumption.

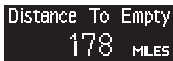
4 Distance To Empty

Displays the estimated maximum distance that can be driven with the quantity of fuel remaining.

- This distance is computed based on your average fuel consumption. As a result, the actual distance that can be driven may differ from that displayed.
- When only a small amount of fuel is added to the tank, the display may not be updated.

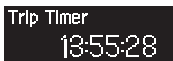
5 Trip Timer

Displays the driving time.

To calculate the driving time, press the SELECT RESET button, and to stop the calculation, press it again.

To reset the calculation, press the SELECT RESET button for more than 2 seconds.

6 Average Speed



Displays the average vehicle speed since the engine was started or the function was reset.

The function can be reset by pushing the SELECT RESET button for more than 2 seconds.

Feature customization

The vehicle can be customized while the vehicle is stopped.

STEP 1 Press the SETUP button to select the item you want to customize unit.

- UNITS
- ↓
- KEYLESS ENTRY FEEDBACK
- ↓
- KEYLESS ENTRY RELOCK TIMER
- ↓
- KEYLESS ENTRY ALL DOORS UNLOCK
- ↓
- DOOR AUTO LOCKING
- ↓
- DOOR AUTO UNLOCKING
- ↓
- HEADLAMPS AUTO OFF TIMER
- ↓
- COURTESY LAMPS OFF TIMER
- ↓
- LANGUAGE
- ↓
- DEFAULT SETTING



STEP 2 Press the SELECT RESET button to customize the items.

Items	Screen text	Select in this order
To select US (ENGLISH) or METRIC (→P. 208)	UNITS	US (ENGLISH) ↔ METRIC
Door lock/unlock warning function	KEYLESS ENTRY FEEDBACK	LAMPS + TONE* → LAMPS ↑ ↓ OFF ← TONE
Time for automatic door lock function	KEYLESS ENTRY RELOCK TIMER	60 SECONDS* → 120 SECONDS ↑ ↓ 30 SECONDS ← OFF
Double switch operation to unlock all the doors	KEYLESS ENTRY ALL DOORS UNLOCK	2 PRESSES* ↔ 1 PRESS
Automatic door locking function	DOOR AUTO LOCKING	SHIFT OUT → ABOVE 12 MPH* OF PARK (20 km/h) ↑ ↓ OFF ←
Automatic door unlocking function	DOOR AUTO UNLOCKING	SHIFT TO PARK* → DRIVER DOOR OPEN ↑ ↓ OFF ←
Time period before lights turn off (if a door is opened and closed, and engine switch is in ACC or LOCK)	HEADLAMPS AUTO OFF TIMER	30 SECONDS* → 60 SECONDS ↑ ↓ 0 SECONDS ← 90 SECONDS
Time period before lights turn off	COURTESY LAMPS OFF TIMER	15 SECONDS* → 30 SECONDS ↑ ↓ 8 SECONDS ←
Selecting the language	LANGUAGE	ENGLISH → FRENCH ↑ ↓ SPANISH ←

Items	Screen text	Select in this order
Reset to default setting	HOLD RESET TO RESTORE DEFAULT SETTINGS	—

*: Default setting

STEP 3 After customize is complete, press the SETUP button to set the selected item.

If the customization fails, the previously setting will be displayed.

If no button is pressed for 10 seconds, the display change to normal display.

■ To select the US (ENGLISH) or METRIC

STEP 1 Press the SETUP button to display UNITS on the multi-information display.

STEP 2 Press the SELECT RESET button to change the units.

STEP 3 Press the INFO or SETUP button and complete the unit change.

Information	US (ENGLISH)	METRIC
Average Fuel Economy and Current Fuel Economy	MPG	L/100 Km
Distance To Empty	MILES	Km
Average Speed	MPH	Km/h
Outside temperature display on the accessory meter	°F	°C

■ Feature customization error

- If SYSTEM ERROR message is indicated, turn the engine switch off and then on again.
- If SYSTEM ERROR message is indicated again, contact your Toyota dealer.

 CAUTION**■ Caution while driving**

Do not adjust the display.

Doing so may cause the driver to mishandle the vehicle and an accident, resulting in death or serious injury.

 NOTICE**■ The multi-information display at low temperatures**

Allow the interior of the vehicle to warm up before using the liquid crystal information display. At extremely low temperatures, the information display monitor may respond slowly, and display changes may be delayed.

2-2. Instrument cluster Accessory meter

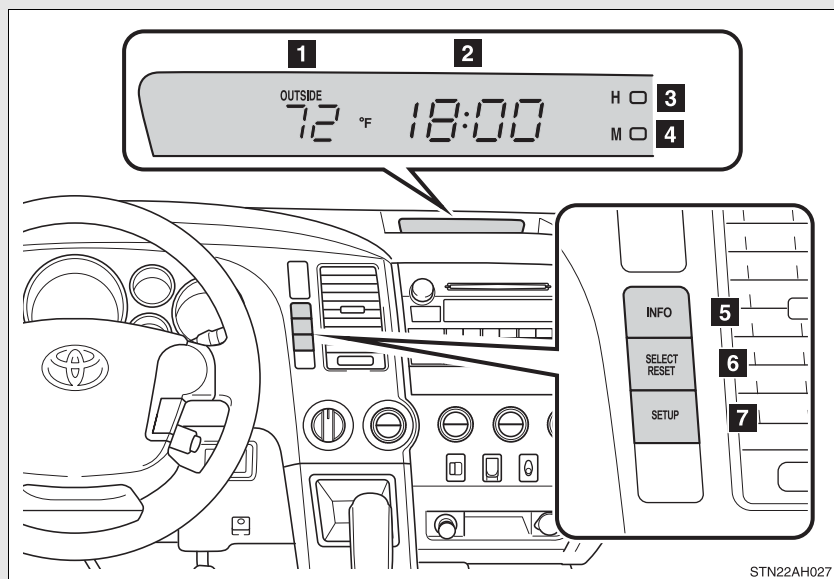

- 1** Outside temperature display (if equipped)
Displays the outside air temperature. (→P. 477)
Outside temperature and trip information display (if equipped)
Displays the outside temperature and trip information.
(→P. 211, 477)
- 2** Clock (→P. 476)
- 3** H (Hour) button (→P. 476)
- 4** M (Minute) button (→P. 476)
- 5** INFO button (if equipped)
- 6** SELECT RESET button (if equipped)
- 7** SETUP button (if equipped)

Outside temperature and trip information display (if equipped)

Every time the INFO button is pushed, the display toggles through these information.

● OUTSIDE (outside temperature display)



Displays the outside air temperature.

● AVG (average fuel consumption after refueling)



Displays the average fuel consumption since the vehicle was last refueled.

The function can be reset by pushing the SELECT RESET button for more than 2 seconds.

● INST (current fuel consumption)

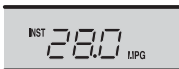

Displays the current rate of fuel consumption.

● RANGE (driving range)



Displays the estimated maximum distance that can be driven with the quantity of fuel remaining.

- This distance is computed based on your average fuel consumption. As a result, the actual distance that can be driven may differ from that displayed.
- When only a small amount of fuel is added to the tank, the display may not be updated.

● Display off



■ **The accessory meter can be operated when**

The engine switch must be in the ON position.

■ **To select the unit A (English/U.S. customary system) or unit B (metric unit) (vehicles without multi-information display)**

Press the SETUP button to change the units.

Information	Unit A	Unit B
Average fuel consumption and current fuel consumption	MPG	L/100 Km
Driving range	MILES	Km
Outside temperature	°F	°C

 **CAUTION**

■ **Caution while driving**

Do not adjust the display.

Doing so may cause the driver to mishandle the vehicle and cause an accident, resulting in death or serious injury.

Headlight switch

The headlights can be operated manually or automatically.

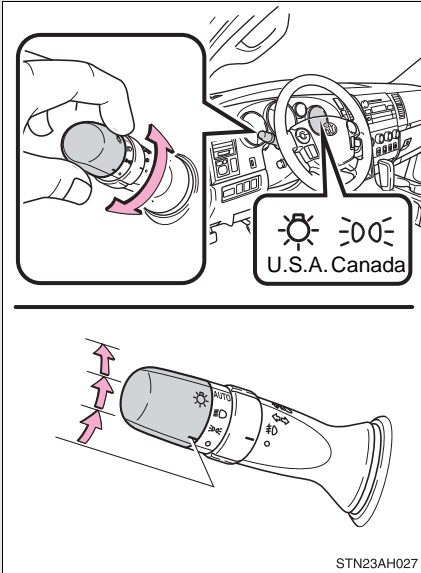

The side marker, parking, tail, license plate and instrument panel lights turn on.



The headlights and all lights listed above turn on.

AUTO

(if equipped)

The headlights and all lights listed above turn on and off automatically. (When the engine switch is in the ON position)

Turning on the high beam headlights

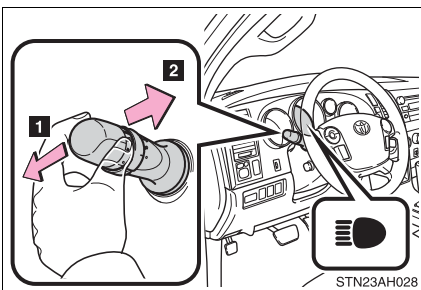

1 With the headlights on, push the lever forward to turn on the high beams.

Pull the lever back to the center position to turn the high beams off.

2 Pull the lever toward you to turn on the high beams.

Release the lever to turn them off. You can flash the high beams with the headlights on or off.

Manual headlight leveling dial (if equipped)

The level of the headlights can be adjusted according to the number of passengers and the loading condition of the vehicle.

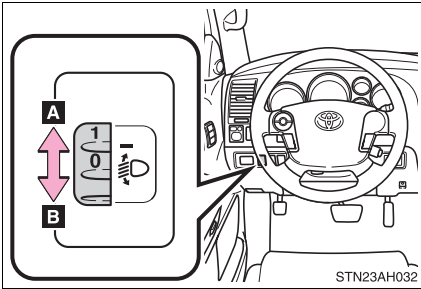

A Raises the level of the headlights

B Lowers the level of the headlights

■ Guide to dial settings

Loading condition		Control switch position				
Towing Hitch (Towing package)	Payload	Regular Cab		Double Cab		CrewMax
		Standard	Long	Standard	Long	Short
None	None	0	0	0	0	0
None	Maximum load	3	2	3	2	3
Maximum load	None	4	3	3	2	3

■ Daytime running light system (if equipped)

To make your vehicle more visible to other drivers, the front turn signal lights turn on automatically whenever the engine is started and the parking brake is released. Daytime running lights are not designed for use at night.

■ Headlight control sensor (vehicles with automatic light control system)

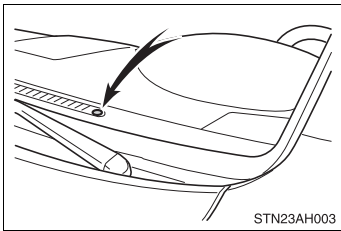



The sensor may not function properly if an object is placed on the sensor, or anything that blocks the sensor is affixed to the windshield.

Doing so interferes with the sensor detecting the level of ambient light and may cause the automatic headlight system to malfunction.

■ Automatic light off system

- When the headlights come on: The headlights and tail lights automatically turn off after 30 seconds when all doors are closed with the engine switch turned to the ACC or LOCK position. (The lights turn off immediately if the  button on the wireless remote control is pressed after all doors are locked.)
- When only the tail lights come on: The tail lights turn off automatically with the engine switch turned to the ACC or LOCK position and the driver's door is opened.

Vehicles with automatic light control system: If any of the doors is kept open, the lights automatically turn off after 20 minutes.

To turn the lights on again, turn the engine switch to the ON position, or turn the headlight switch off once and then back to the  or  position.

■ Customization

- That can be configured at Toyota dealer (vehicles without multi-information display)

Settings (automatic light off system) can be changed. (Customizable features →P. 684)

- It is possible to change the settings (vehicles with multi-information display) (Feature customization →P. 206)



NOTICE

■ **To prevent battery discharge**

Do not leave the lights on longer than necessary when the engine is not running.

Fog light switch*

The fog lights improve visibility in difficult driving conditions, such as in rain or fog.

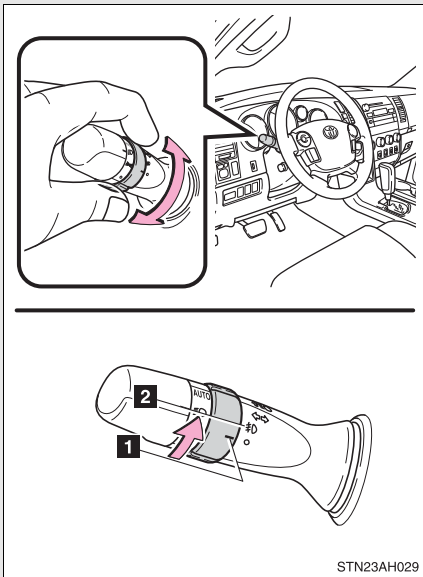

1 OFF

2 ON

- **The fog lights can be turned on only when**
The headlights are on low beam.

*: If equipped

2-3. Operating the lights and wipers Windshield wipers and washer

■ Without intermittent type

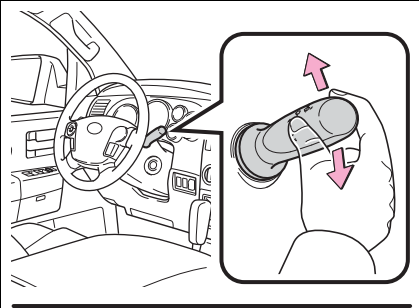

- 1 Low speed windshield wiper operation
- 2 High speed windshield wiper operation
- 3 Temporary operation

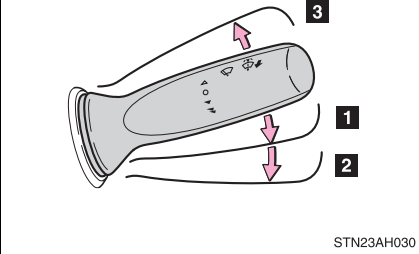

STN23AH030

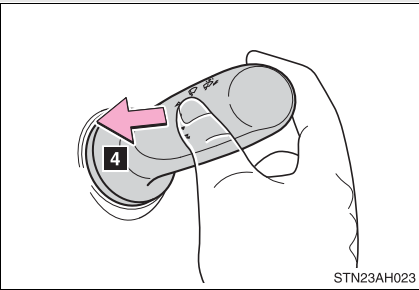

STN23AH023

- 4 Washer operation

■ Intermittent wiper with interval adjuster

Wiper intervals can be adjusted for intermittent operation (when  is selected).

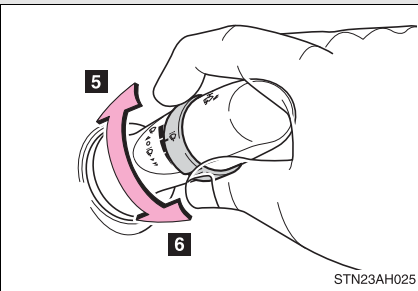
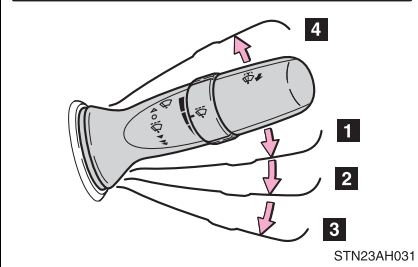
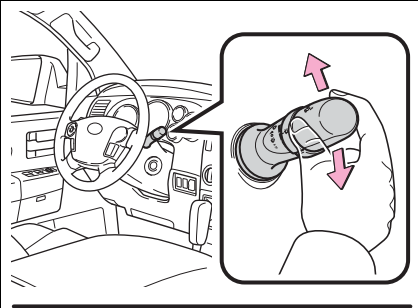

1 Intermittent windshield wiper operation

2 Low speed windshield wiper operation

3 High speed windshield wiper operation

4 Temporary operation

5 Increases the intermittent windshield wiper frequency

6 Decreases the intermittent windshield wiper frequency

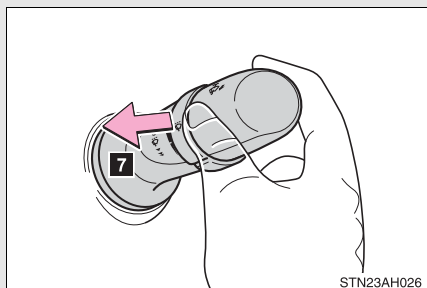

7 Washer/wiper dual operation

Wipers will automatically operate a couple of times after the washer squirts.

■ **The windshield wiper and washer can be operated when**

The engine switch must be in the ON position.

■ **If no windshield washer fluid sprays**

Check that the washer nozzles are not blocked and if there is washer fluid in the windshield washer fluid reservoir.

⚠ NOTICE

■ **When the windshield is dry**

Do not use the wipers, as they may damage the windshield.

■ **When there is no washer fluid spray from the nozzle**

Damage to the washer fluid pump may be caused if the lever is pulled toward you and held continually.

■ **When a windshield washer nozzle becomes blocked**

Contact your Toyota dealer. Do not try to clear it with a pin or other object. This may damage the nozzle.

2-4. Using other driving systems Cruise control*

Use cruise control to maintain a set speed without using the accelerator.

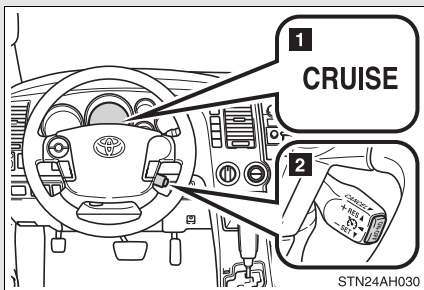

- 1 Indicator
- 2 Cruise control switch

■ Set the vehicle speed

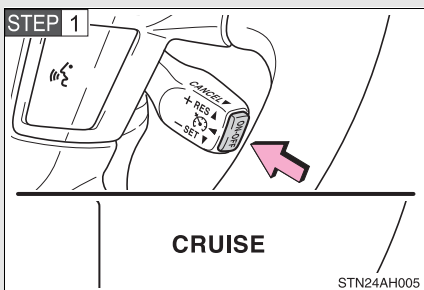

Press the ON-OFF button to turn the cruise control on.

At this time, the cruise control indicator will come on.

Press the button once more to deactivate the cruise control.

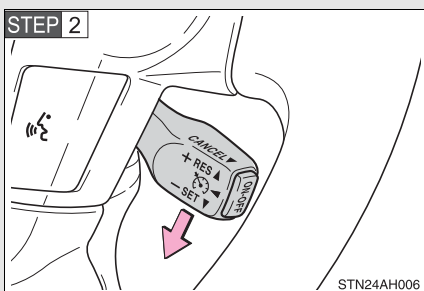

Accelerate or decelerate to the desired speed and push the lever down to set the cruise control speed.

*: If equipped

■ Adjusting the speed setting

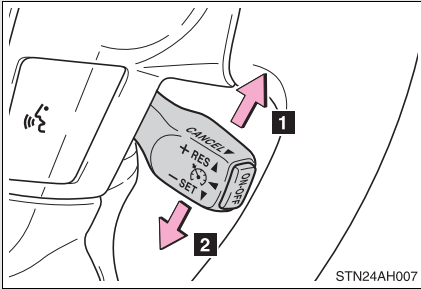

1 Increase speed

2 Decrease speed

Hold the lever until the desired speed setting is obtained.

Fine adjustment of the set speed (approximately 1.0 mph [1.6 km/h]) can be made by lightly pushing the lever up or down and releasing it.

■ Canceling and resuming regular acceleration

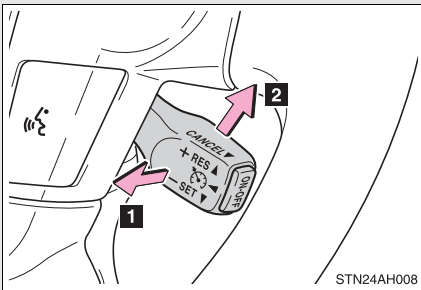

1 Cancel

Pull the lever towards you to cancel cruise control.

The speed setting is also canceled when the brakes are applied.

2 Resume

To resume cruise control and return to the set speed, push the lever up.

■ Cruise control can be set when

- The shift lever is in D or the shift range position must be in 4 or 5 in S mode (5-speed models).
- The shift lever is in D or the shift range position must be in between 4 and 6 in S mode (6-speed models).
- Vehicle speed is more than approximately 25 mph (40 km/h).

■ Accelerating

The vehicle can be accelerated normally. After acceleration, the set speed resumes.

■ Automatic cruise control cancellation

The set speed is automatically cancelled in any of the following situations.

- Actual vehicle speed falls more than 10 mph (16 km/h) below the preset vehicle speed.
At this time, the memorized set speed is not retained.
- Actual vehicle speed is below 25 mph (40 km/h).
- VSC is activated.

■ If the cruise control indicator flashes

Press the ON-OFF button to turn the cruise control off, and then reactivate the system.

If the cruise control speed cannot be set or if the cruise control cancels immediately after being activated, there may be a malfunction in the cruise control system. Have the vehicle inspected by your Toyota dealer.

CAUTION

■ To avoid operating the cruise control by mistake

Keep the ON-OFF button off when not in use.

■ Situations unsuitable for cruise control

Do not use cruise control in any of the following situations.

Doing so may result in control of the vehicle being lost and could cause an accident resulting in death or serious injury.

- In heavy traffic
- On roads with sharp bends
- On winding roads
- On slippery roads, such as those covered with rain, ice or snow
- On steep hills
- When towing a trailer or emergency towing

2-4. Using other driving systems Intuitive parking assist*

The intuitive parking assist is designed to inform you of the approximate distance between your vehicle and an obstruction by indicator and buzzer when parking the vehicle. This system uses sensors to detect obstructions.

■ Sensor types

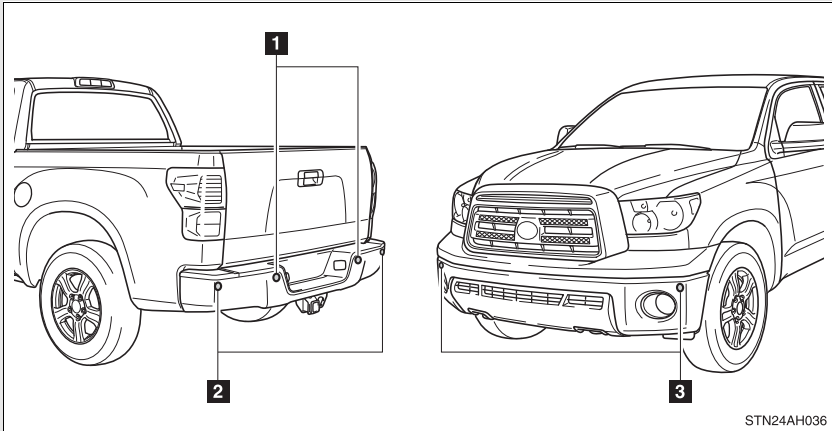

1 Back sensors

2 Rear corner sensors

3 Front corner sensors

■ Intuitive parking assist switch

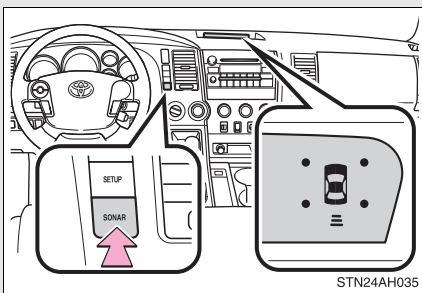

Press the switch to turn on. (To turn off, press the switch again.)

When on, the buzzer sounds to inform the driver that the system is operational. At this time, the indicator will come on.

*: If equipped

The distance and buzzer

■ When a sensor detects an obstacle.

The buzzer sounds.

► Back sensors

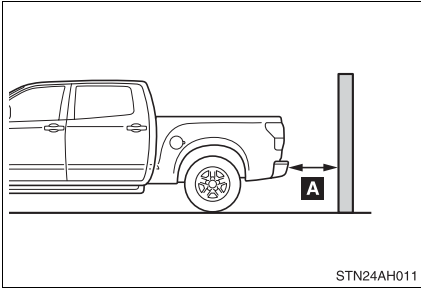

Zone	Distance shown as A in in. (mm)	Indicator and buzzer
Far	Approximately 70.9—45.3 (1800—1150)	Intermittent
Mid	Approximately 45.3—33.5 (1150—850)	Fast intermittent
Near	Approximately 33.5 (850) or less	Continuous

► Rear corner sensors

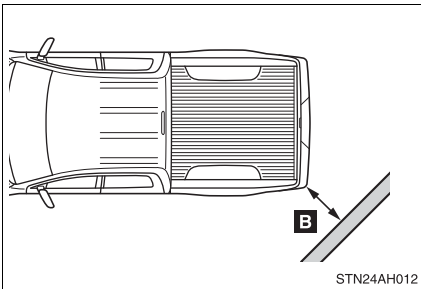

Zone	Distance shown as B in in. (mm)	Indicator and buzzer
Far	Approximately 33.5—20.5 (850—520)	Intermittent
Mid	Approximately 20.5—15.7 (520—400)	Fast intermittent
Near	Approximately 15.7 (400) or less	Continuous

► Front corner sensors

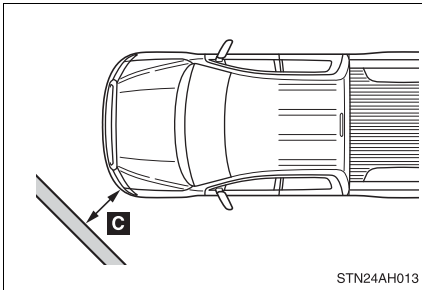

Zone	Distance shown as C in in. (mm)	Indicator and buzzer
Far	Approximately 23.6—15.7 (600—400)	Intermittent
Mid	Approximately 15.7—9.8 (400—250)	Fast intermittent
Near	Approximately 9.8 (250) or less	Continuous

■ **When two or more obstacles are detected simultaneously**

The buzzer system responds to the nearest zone.

■ **When multiple obstacles are detected in front and behind the vehicle at the same time**

The buzzer will change in the following manner.

- If an obstacle has been detected within 15.7 in. (400 mm) of the front or 33.5 in. (850 mm) in rear of the vehicle (a continuous buzzer is sounding), and a new obstacle is detected at the other end of the vehicle, the buzzer will sound 7 times then one continuous buzzer.
- If an obstacle has been detected within 15.7 in. (400 mm) of the front or 33.5 in. (850 mm) in rear of the vehicle (a continuous buzzer is sounding), and a new obstacle is detected in the same way at the other end of the vehicle, the buzzer will sound 3 times then one continuous buzzer.

Sensors that operate and detection range

The following diagrams show the sensor detection range. Note that sensors may not be able to detect obstacles that are extremely close to the vehicle.

■ Detection range of the sensors

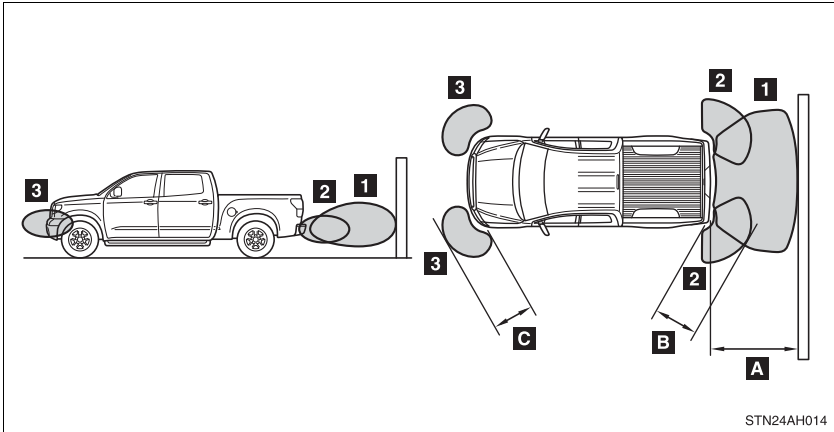

- 1 Back sensors
- 2 Rear corner sensors
- 3 Front corner sensors

Perceptible area

- A Approx. 70.9 in. (1800 mm)
- B Approx. 33.5 in. (850 mm)
- C Approx. 23.6 in. (600 mm)

The diagram shows the detection range of the sensors. Note that the sensors may not be able to detect obstacles that are extremely close to the vehicle.

The range of the sensors may change depending on the shape of the object etc.

■ **The Intuitive parking assist system can be operated when**

● **Front corner sensors:**

- The engine switch is in the ON position.
- The shift lever is in R.
- The shift lever is not in P or R and vehicle speed is approximate 6 mph (10 km/h) or less.

● **Back and rear corner sensors:**

- The engine switch is in the ON position.
- The shift lever is in R

■ **Sensor detection information**

● **Certain vehicle conditions and the surrounding environment may affect the ability of a sensor to correctly detect an obstacle. Particular instances where this may occur are listed below.**

- There is dirt, snow or ice on a sensor.
- A sensor is frozen.
- A sensor is covered in any way.
- The vehicle is leaning considerably to one side.
- On an extremely bumpy road, on an incline, on gravel, or on grass.
- The vicinity of the vehicle is noisy due to vehicle horns, motorcycle engines, air brakes of large vehicles, or other loud noises producing ultrasonic waves.
- There is another vehicle equipped with intuitive parking assist sensors in the vicinity.
- A sensor is coated with a sheet of spray or heavy rain.
- The vehicle is equipped with a fender pole or radio antenna.
- A bumper or sensor receives a strong impact.
- The vehicle is approaching a tall or right-angled curb.
- In harsh sunlight or intense cold weather.
- The area directly under the bumpers is not detected.
Objects lower than the sensors or thin stakes etc. may be detected initially, but as they draw closer, they may cease to be detected.
- A towing hitch is mounted to the vehicle.
- A non-genuine Toyota suspension (lowered suspension etc.) is installed.
- When attaching a two-way radio antenna.
- When the bumper is damaged.

In addition to the examples above, there are instances in which, because of their shapes, signs and other objects may be judged by a sensor to be closer than they are.

- The shape of the obstacle may prevent a sensor from detecting it. Pay particular attention to the following obstacles:
 - Wires, fences, ropes, etc.
 - Cotton, snow and other materials that absorb radio waves
 - Sharply-angled objects
 - Low obstacles
 - Tall obstacles with upper sections projecting outwards in the direction of your vehicle
 - A person near the vehicle (depending on the type of clothes worn)
 - When the bumper is damaged.

■ Certification (Canada only)

This ISM device complies with Canadian ICES-001.

■ If the indicator is continuously on

Have the vehicle inspected by your Toyota dealer.

■ If the indicator remains blinking but do not sound the buzzer

Clean the sensors with soft cloth.

CAUTION

■ Caution when using the intuitive parking assist

Observe the following precautions.

Failure to do so may result in the vehicle being unable to be driven safely and possibly cause an accident.

- Do not use the sensor at speeds in excess of 6 mph (10 km/h).
- Do not attach any accessories within the sensor range.

NOTICE

■ Notes when washing the vehicle

Do not apply intensive bursts of water or steam to the sensor area. Doing so may result in the sensor malfunctioning.

Rear view monitor system*

The rear view monitor system assists the driver by displaying an image of the area behind the vehicle. The image is displayed in reverse on the screen. This reversed image is a similar image to the one on the inside rear view mirror.

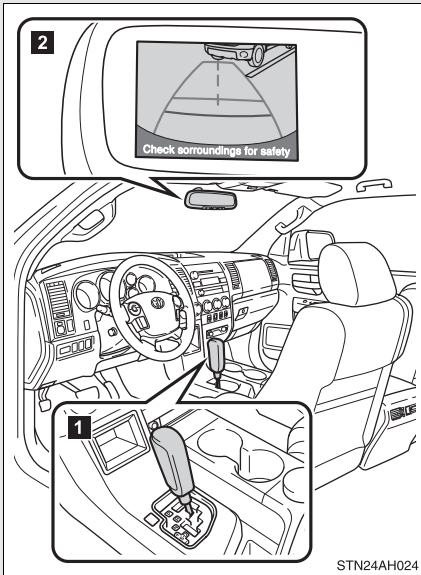

The rear view image is displayed on the inside rear view mirror.

The screen is turned off if any one of the following conditions are met:

- The shift lever is shifted out of R
- The screen remains on for 5 minutes

1 Shift lever

2 Screen

*: If equipped

■ Rear view monitor guide lines

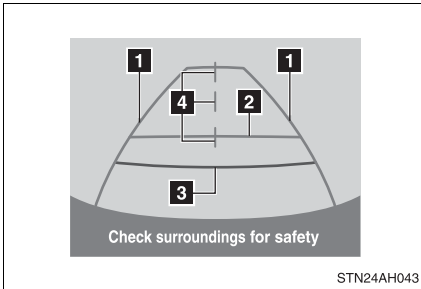

- Guide lines are displayed on the monitor.

1 Vehicle width extension guide lines (blue)

These lines indicate the estimated vehicle width extension.

2 Distance guide line (blue)

This line indicates a position on the ground about 3 ft. (1 m) behind on the ground of the rear bumper of your vehicle.

3 Distance guide line (red)

This line indicates a position on the ground about 1.5 ft. (0.5 m) behind on the ground of the rear bumper of your vehicle.

4 Vehicle center guide lines (blue)

These lines indicate the estimated vehicle center on the ground.

■ **The rear view monitor system can be operated when**

The shift lever is in R and engine switch is ON.

■ **Display mode**

The rear view monitor display mode can be adjusted when the engine switch is in the ON position and the shift lever is in R.

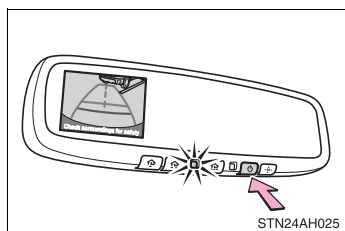

Push the  button.

- To temporarily turn off the monitor when it is on.

Push the  button. The indicator should turn orange.

The monitor will automatically turn on again after the ignition is turned off and on.

- To manually turn on the monitor when it is turned off.

Push the  button. The indicator should turn green.

- To select a display language (English, French, or Spanish).

STEP 1 Push and hold the  button for 6 to 12 seconds.

The monitor should turn on and the indicator should turn green.

STEP 2 Push the  button.

STEP 3 Each time the  button is pushed and released, the language will change. The warning message should flash 5 seconds after the button is released, indicating that the change has been completed.

- To permanently disable the monitor.

Push and hold the  button for 12 to 15 seconds.

The monitor will turn off and on after 6 seconds. Continue holding the button down until the display turns back off.

The indicator should flash orange.

The monitor will not automatically turn on again after the ignition is turned off and on.

■ Displayed area

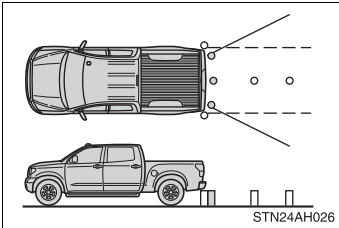

The area covered by the camera is limited. Objects that are close to either corner of the bumper or under the bumper cannot be seen on the screen.

The area displayed on the screen may vary according to vehicle orientation or road conditions.

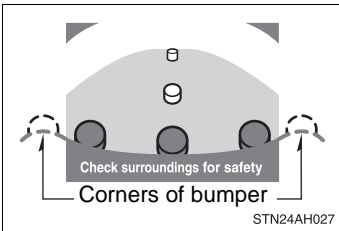

■ Rear view monitor system camera

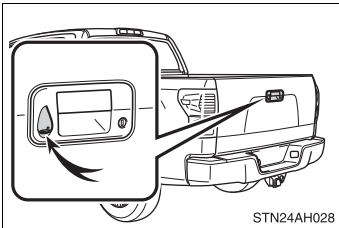

In the following cases, it may become difficult to see the images on the screen, even when the system is functioning correctly.

- The vehicle is in a dark area, such as at night.
- The temperature near the lens is extremely high or low.
- Water droplets are on the camera lens or humidity is high, such as when it rains.
- Foreign matter, such as snow or mud, adheres to the camera lens.
- The sun or headlights are shining directly into the camera lens.
- A bright object such as a white wall is reflected in the mirror surface over the monitor.

■ Smear effect

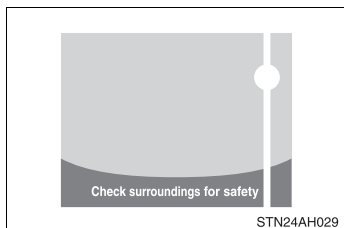

If a bright light, such as sunlight reflected off the vehicle body, is picked up by the camera, a smear effect* characteristic to the camera may occur.

*: Smear effect: A phenomenon that occurs when a bright light is picked up by the camera; when transmitted by the camera, the light source appears to have a vertical streak above and below it.

⚠ CAUTION

■ **When using the rear view monitor system, observe the following precautions to avoid an accident that could result in death or serious injuries.**

- Never depend solely on the monitor system when reversing.
- Always check visually and with the mirrors to confirm your intended path is clear.
- Always check the vehicle surrounding area, because the guide lines are ancillary lines.
- The guide lines are ancillary lines and does not change even if the steering wheel is turned.
- Depicted distances between objects and flat surfaces differ from actual distances.
- Do not use the system if the tailgate open.

 CAUTION**■ Conditions which may affect the rear view monitor system**

- If the back of the vehicle has been hit, the camera's position and mounting angle may have changed. Have the vehicle inspected by your Toyota dealer.
- Rapid temperature changes, such as when hot water is poured on the vehicle in cold weather, may cause the system to function abnormally.
- If the camera lens is dirty, it cannot transmit a clear image. Rinse with water and wipe with a soft cloth. If extremely dirty, wash with a mild cleanser and rinse.
- The displayed image may be darker and moving images may be slightly distorted when the system is cold.

■ Caution while driving in reverse

- Do not change modes while the vehicle is moving.

 NOTICE

- As the camera has a water proof construction, do not detach, disassemble or modify it. This may cause incorrect operation.
- If the camera lens becomes dirty, it cannot transmit a clear image. If water droplets, snow, or mud adhere to the lens, rinse with water and wipe with a soft cloth. If the lens is extremely dirty, wash it with a mild cleanser and rinse.

2-4. Using other driving systems

Four-wheel drive system*

Use the front-wheel drive control switch to select the following transfer modes.

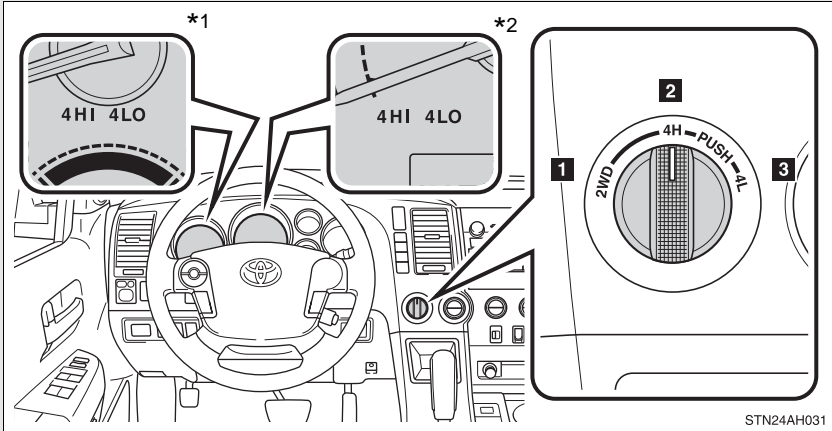

*1: Vehicles with multi-information display

*2: Vehicles without multi-information display

1 2WD (high speed position, two-wheel drive)

Normal driving.

2 4H (high speed position, four-wheel drive)

Greater traction than two-wheel drive.

When you experience a loss of power, such as wheel slipping.

The 4HI indicator will come on.

3 4L (low speed position, four-wheel drive)

Driving requiring maximum power and traction such as climbing or descending steep hills, off-road driving and hard pulling in sand or mud, etc.

The 4LO indicator will come on.

*: If equipped

Shifting between 4H and 4L

■ Shifting from 4H to 4L

STEP 1 Stop the vehicle completely.

STEP 2 Shift the shift lever to N.

STEP 3 Push and turn the front-wheel drive control switch fully clockwise.

Maintain this condition until the 4LO indicator comes on.

■ Shifting from 4L to 4H

STEP 1 Stop the vehicle completely.

STEP 2 Shift the shift lever to N.

STEP 3 Turn the front-wheel drive control switch fully counterclockwise.

Maintain this condition until the 4LO indicator turns off.

■ Shifting between 2WD and 4H

Reduce your speed to less than 62 mph (100 km/h) and set the front drive control switch between 2WD and 4H.

When the ambient temperature is 5.0°F (-15°C) or lower, shifting from 2WD to 4H can be performed with the vehicle speed below 43 mph (70 km/h).

■ If the 4HI indicator blinks

● Shifting from 2WD to 4H

- If the 4HI indicator continues to blink, drive straight ahead while accelerating or decelerating.
- If the 4HI indicator continues to blink and the buzzer sounds, stop the vehicle or reduce the vehicle speed to less than 62 mph (100 km/h). Operate the switch again.

● Shifting from 4H to 2WD

If the 4HI indicator continues to blink, drive straight ahead while accelerating or decelerating, or drive forward or backward in a short distance.

■ **If the 4LO indicator light blinks**

- If the 4LO indicator continues to blink when shifting between 4H and 4L, stop the vehicle completely, move the shift lever to N and operate the switch again.
- If the shift lever is moved before the 4LO indicator turns on/off, the transfer mode may not be shifted completely. The transfer mode disengages both the front and rear driveshafts from the powertrain and allows the vehicle to move regardless of the shift position. (At this time, the indicator blinks and the buzzer sounds.)

Therefore, the vehicle is free to roll even if the automatic transmission is in P. You or someone else could be seriously injured. You must complete the shifting of the transfer mode.

To complete the shifting, stop the vehicle completely, return the shift lever to N, and confirm that the shift was completed (The indicator turns on/off).

- If the engine coolant temperature is too low, the transfer mode may not be able to be shifted. When the engine is warmer, operate the switch again.

If the 4LO indicator light continues to blink even after attempting the above, there may be a malfunction in the engine, the brake system or the four-wheel drive system. In this case, you may not be able to shift between 4H and 4L. Have the vehicle inspected by your Toyota dealer immediately.

■ **Shifting to 4L**

VSC is automatically turned off.

■ **Four-wheel drive usage frequency**

You should drive in four-wheel drive for at least 10 miles (16 km) each month.

This will assure that the front drive components are lubricated.

 **CAUTION****■ Caution while driving**

Never operate the front-wheel drive control switch if the wheels are slipping. Stop the slipping or spinning before shifting.

■ When the vehicle is parked

If the shift lever is moved before the 4LO indicator turns on/off, the transfer mode may not be shifted completely. The transfer mode disengages both the front and rear driveshafts from the powertrain and allows the vehicle to move regardless of the shift position. (At this time, the indicator blinks and the buzzer sounds.)

Therefore, the vehicle is free to roll even if the automatic transmission is in P. You or someone else could be seriously injured. You must complete the shifting of the transfer mode. (→P. 238)

AUTO LSD system

The AUTO LSD system aids traction by using the traction control system to control engine performance and braking when one of the rear wheels begins to spin.

The system should be used only when one of the rear wheels spinning occurs in a ditch or rough surface.

■ System operation

The system can be used on 2WD models and in 2WD mode on 4WD models.

The system is activated when driving at a speed under 62 mph (100 km/h).

The AUTO LSD system will be activated with the following two procedures.

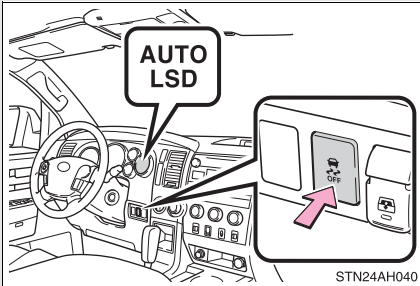

Press the VSC OFF switch briefly.

At this time, the AUTO LSD indicator will come on.

To turn off the system, push the switch again.

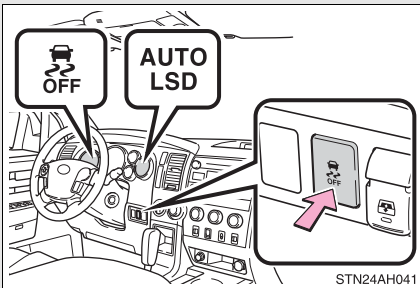

Stop the vehicle completely, and press the VSC OFF switch for more than 3 seconds.

At this time, the VSC OFF and AUTO LSD indicators will come on simultaneously.

To turn off the system, push the switch again.

When the AUTO LSD system is operating

► Vehicles with multi-information display

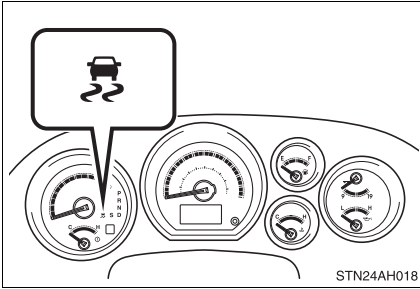

If the rear wheels spin, the slip indicator flashes to indicate that the AUTO LSD system have been controlled the spinning of the rear wheels.

► Vehicles without multi-information display

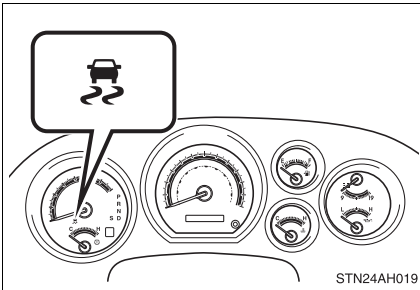

■ If the engine is turned off and restarted

The AUTO LSD system and the indicators are automatically turned off.

■ If the brake system overheats

The system will cease operation and a buzzer will sound to alert the driver. The TRAC OFF indicator will come on. Stop the vehicle in a safe place. (There is no problem with continuing normal driving.)

The system will be automatically restored after a short time.

 CAUTION

■ **To avoid an accident**

- Do not use the AUTO LSD system in conditions other than the above.
A much greater steering effort and more careful cornering control will be required.
- Do not drive with the AUTO LSD system continuously turned on.

Driving assist systems

To help enhance driving safety and performance, the following systems operate automatically in response to various driving situations. Be aware, however, that these systems are supplementary and should not be relied upon too heavily when operating the vehicle.

■ **ABS (Anti-lock Brake System)**

Helps to prevent wheel lock when the brakes are applied suddenly, or if the brakes are applied while driving on a slippery road surface.

■ **Brake Assist**

Generates an increased level of braking force after the brake pedal is depressed, when the system detects a panic stop situation.

■ **VSC (Vehicle Stability Control)**

Helps the driver to control skidding when swerving suddenly or turning on slippery road surfaces.

■ **TRAC (Traction Control) for 2WD models and 2WD mode on 4WD models**

Maintains drive power and prevents the rear wheels from spinning when starting the vehicle or accelerating on slippery roads.

■ **A-TRAC (Active Traction Control) for 4WD mode on 4WD models**

Maintains drive power and prevents the all wheels from spinning when starting the vehicle or accelerating on slippery roads.

When VSC/TRAC/A-TRAC are operating

► Vehicles with multi-information display

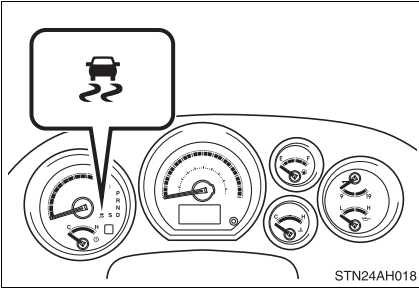

If the vehicle is in danger of slipping, or if the rear wheels (2WD models and 2WD mode on 4WD models) or all wheels (4WD mode on 4WD models) spin, the slip indicator flashes to indicate that VSC/TRAC/A-TRAC have been engaged.

A buzzer (intermittent) sounds to indicate that VSC is operating.

► Vehicles without multi-information display

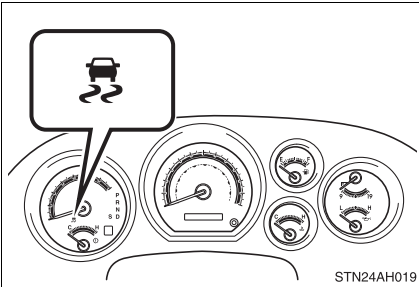

If the vehicle is in danger of slipping, or if the rear wheels (2WD models and 2WD mode on 4WD models) or all wheels (4WD mode on 4WD models) spin, the slip indicator flashes to indicate that VSC/TRAC/A-TRAC have been engaged.

A buzzer (intermittent) sounds to indicate that VSC is operating.

To disable VSC and/or TRAC (2WD models and 2WD mode on 4WD models)

If the vehicle gets stuck in fresh snow or mud, VSC and TRAC may reduce power from the engine to the wheels. You may need to turn the system off to enable you to rock the vehicle in order to free it.

■ TRAC OFF mode

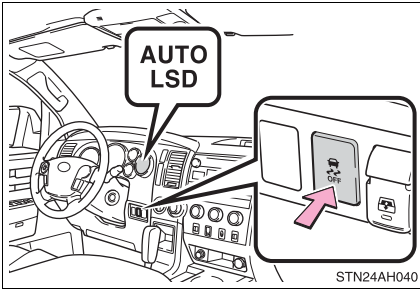

Press the VSC OFF switch briefly.

The AUTO LSD indicator will come on.

The system is in TRAC off, AUTO LSD on and VSC on mode.

Push the switch again to turn the system back on.

■ AUTO LSD mode

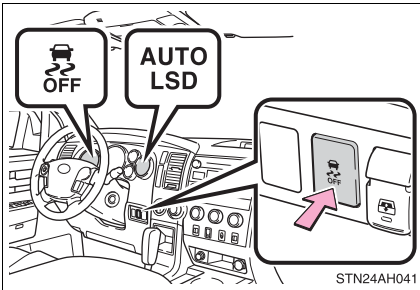

Stop the vehicle completely, and press the VSC OFF switch for more than 3 seconds, when the system is in the TRAC OFF mode.

The VSC OFF and AUTO LSD indicators will come on.

The system is in TRAC off, AUTO LSD on and VSC off mode.

■ VSC OFF mode

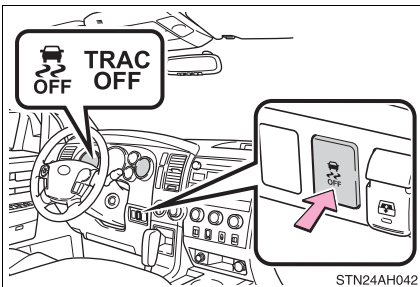

Stop the vehicle completely, and press the VSC OFF switch for more than 3 seconds, when the system is in the AUTO LSD mode.

The VSC OFF and TRAC OFF indicators will come on.

The system is all off mode.

To disable VSC or A-TRAC (4H mode on 4WD models)

If the vehicle gets stuck in fresh snow or mud, VSC or A-TRAC may reduce power from the engine to the wheels. You may need to turn the system off to enable you to rock the vehicle in order to free it.

■ A-TRAC OFF mode

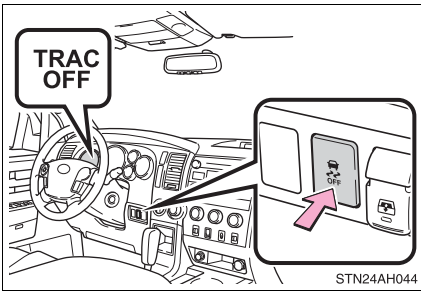

Press the VSC OFF switch briefly.

The TRAC OFF indicator will come on.

The system is in A-TRAC off and VSC on mode.

Push the switch again to turn the system back on.

■ VSC OFF mode

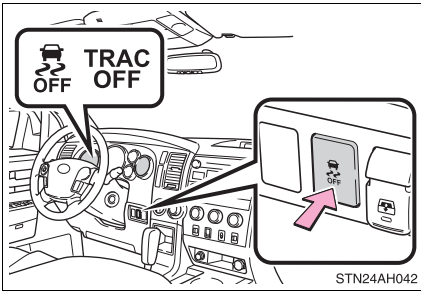

Stop the vehicle completely, and press the VSC OFF switch for more than 3 seconds.

The VSC OFF and TRAC OFF indicators will come on.

The system is all off mode.

Push the switch again to turn the system back on.

To disable A-TRAC (4L mode on 4WD models)

If the vehicle gets stuck in fresh snow or mud, A-TRAC may reduce power from the engine to the wheels. You may need to turn the system off to enable you to rock the vehicle in order to free it.

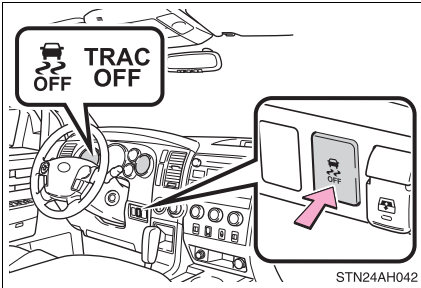

Stop the vehicle completely, and press the VSC OFF switch for more than 3 seconds.

The TRAC OFF indicators will come on.

Push the switch again to turn the system back on.

2

When driving

■ Automatic reactivation of TRAC, A-TRAC and VSC

Turning the engine switch off after turning off the TRAC, A-TRAC and VSC systems will automatically re-enable them.

■ Sounds and vibrations caused by the ABS, TRAC, A-TRAC, VSC and brake assist system

- A sound may be heard from the engine compartment when the engine is started and just after the vehicle begins to move. This sound does not indicate that a malfunction has occurred in any of these systems.
- Any of the following conditions may occur when the above systems are operating. None of these indicates that a malfunction has occurred.
 - Vibrations may be felt through the vehicle body and steering.
 - A motor sound may be heard after the vehicle comes to a stop.
 - The brake pedal may pulsate slightly after the ABS is activated.
 - The brake pedal may move down slightly after the ABS is activated.

■ If the brake system overheats

TRAC or A-TRAC will cease operation and a buzzer will sound to alert the driver. The TRAC OFF indicator will come on. Stop the vehicle in a safe place. (There is no problem with continuing normal driving.)

■ Shifting to 4L

VSC is automatically turned off.

 **CAUTION**

Any of the following conditions may result in an accident which could cause death or serious injury.

■ **The ABS does not operate effectively when**

- The limits of the gripping performance have been exceeded.
- The vehicle hydroplanes while driving at high speed on the wet or slick road.

■ **Stopping distance when the ABS is operating will exceed that of normal conditions**

The ABS is not designed to shorten the vehicle's stopping distance. Always maintain a safe distance from the vehicle in front of you in the following situations.

- When driving on dirt, gravel or snow-covered roads
- When driving with tire chains
- When driving over bumps in the road
- When driving over roads with potholes or roads with uneven roads

■ **When VSC is activated**

The slip indicator flashes and a warning buzzer sounds. Always drive carefully. Reckless driving may cause an accident. Exercise particular care when the indicator flashes and a buzzer sounds.

■ **TRAC or A-TRAC may not operate effectively when**

Directional control and power may not be achievable while driving on slippery road surfaces, even if TRAC or A-TRAC is operating.

Do not drive the vehicle in conditions where stability and power may be lost.

■ **Replacing tires**

Make sure that all tires are of the same size, brand, tread pattern and total load capacity. In addition, make sure that the tires are inflated to the appropriate tire pressure level.

The ABS and VSC will not function correctly if different tires are fitted on the vehicle.

Contact your Toyota dealer for further information when replacing tires or wheels.

 CAUTION

■ **Handling of tires and suspension**

Using tires with any kind of problem or modifying the suspension will affect the driving assist systems, and may cause the system to malfunction.

Off-road precautions

This vehicle has higher ground clearance and narrower tread in relation to the height of its center of gravity to make it capable of performing in a wide variety of off-road applications.

Off-road vehicle feature

- Specific design characteristics give it a higher center of gravity than ordinary passenger cars. This vehicle design feature causes this type of vehicle to be more likely to rollover. And, it has a significantly higher rollover rate than other types of vehicles.
- An advantage of the higher ground clearance is a better view of the road allowing you to anticipate problems.
- It is not designed for cornering at the same speeds as ordinary passenger cars any more than low-slung sports cars are designed to perform satisfactorily under off-road conditions. Therefore, sharp turns at excessive speeds may cause rollover.

 CAUTION**Off-road vehicle precautions**

Always observe the following precautions to minimize the risk of serious personal injury or damage to your vehicle:

- In a rollover crash, an unbelted person is significantly more likely to die than a person wearing a seat belt. Therefore, the driver and all passengers should fasten their seat belts whenever the vehicle is moving.
- Avoid sharp turns or abrupt maneuvers, if at all possible.
Failure to operate this vehicle correctly may result in loss of control or vehicle rollover causing death or serious injury.
- Avoid loading any items on the roof that will raise the vehicle's center of gravity.
- Always slow down in gusty crosswinds. Because of its profile and higher center of gravity, your vehicle is more sensitive to side winds than an ordinary passenger car. Slowing down will allow you to have much better control.
- When driving off-road or in rugged terrain, do not drive at excessive speeds, jump, make sharp turns, strike objects, etc. This may cause loss of control or vehicle rollover causing death or serious injury. You are also risking expensive damage to your vehicle's suspension and chassis.
- Do not drive horizontally across steep slopes. Driving straight up or straight down is preferred. Your vehicle (or any similar off-road vehicle) can tip over sideways much more easily than forward or backward.

Off-road driving

When driving your vehicle off-road, please observe the following precautions to ensure your driving enjoyment and to help prevent the closure of areas to off-road vehicles.

- Drive your vehicle only in areas where off-road vehicles are permitted to travel.
- Respect private property. Get owner's permission before entering private property.
- Do not enter areas that are closed. Honor gates, barriers and signs that restrict travel.
- Stay on established roads. When conditions are wet, driving techniques should be changed or travel delayed to prevent damage to roads.

■ Additional information for off-road driving

► For owners in U.S. mainland, Hawaii and Puerto Rico:

To obtain additional information pertaining to driving your vehicle off-road, consult the following organizations.

- State and Local Parks and Recreation Departments
- State Motor Vehicle Bureau
- Recreational Vehicle Clubs
- U.S. Forest Service and Bureau of Land Management

 CAUTION**Off-road driving precautions**

Always observe the following precautions to minimize the risk of serious personal injury or damage to your vehicle:

- Drive carefully when off the road. Do not take unnecessary risks by driving in dangerous places.
- Do not grip the steering wheel spokes when driving off-road. A bad bump could jerk the wheel and injure your hands. Keep both hands and especially your thumbs on the outside of the rim.
- Always check your brakes for effectiveness immediately after driving in sand, mud, water or snow.
- After driving through tall grass, mud, rock, sand, rivers, etc., check that there is no grass, bush, paper, rags, stone, sand, etc. adhering or trapped on the underbody. Clear off any such matter from the underbody. If the vehicle is used with these materials trapped or adhering to the underbody, a breakdown or fire could occur.
- In a rollover crash, an unbelted person is significantly more likely to die than a person wearing a seat belt. Therefore, the driver and all passengers should fasten their seat belts whenever the vehicle is moving.
- When driving off-road or in rugged terrain, do not drive at excessive speeds, jump, make sharp turns, strike objects, etc. This may cause loss of control or vehicle rollover causing death or serious injury. You are also risking expensive damage to your vehicle's suspension and chassis.

 NOTICE

■ **To prevent the water damage**

- Take all necessary safety measures to ensure that water damage to the engine or other components does not occur.
- Water entering the engine air intake will cause severe engine damage.
- Water entering the automatic transmission will cause deterioration in shift quality, locking up of your transmission accompanied by vibration, and ultimately damage.
- Water can wash the grease from wheel bearings, causing rusting and premature failure, and may also enter the differentials, transmission and transfer case, reducing the gear oil's lubricating qualities.

■ **When you drive through water**

If driving through water, such as when crossing shallow streams, first check the depth of the water and the bottom of the river bed for firmness. Drive slowly and avoid deep water.

■ **Inspection after off-road driving**

- Sand and mud that has accumulated in brake drums and around brake discs may affect braking efficiency and may damage brake system components.
- Always perform a maintenance inspection after each day of off-road driving that has taken you through rough terrain, sand, mud, or water. For scheduled maintenance information, refer to the "Scheduled Maintenance Guide" or "Owner's Manual Supplement".

2-5. Driving information

Cargo and luggage

Take notice of the following information about storage precautions, cargo capacity and load.

- Stow cargo and luggage in the rear deck whenever possible.
- Be sure all items are secured in place.
- Be careful to keep the vehicle level. Placing the weight as far forward as possible helps maintain vehicle balance.
- For better fuel economy, do not carry unnecessary weight.

Capacity and distribution

Cargo capacity depends on the total weight of the occupants.

(Cargo capacity) = (Total load capacity) – (Total weight of occupants)

Steps for Determining Correct Load Limit—

- (1) Locate the statement “The combined weight of occupants and cargo should never exceed XXX kg or XXX lbs.” on your vehicle’s placard.
- (2) Determine the combined weight of the driver and passengers that will be riding in your vehicle.
- (3) Subtract the combined weight of the driver and passengers from XXX kg or XXX lbs.
- (4) The resulting figure equals the available amount of cargo and luggage load capacity.
For example, if the “XXX” amount equals 1400 lbs. and there will be five 150 lb passengers in your vehicle, the amount of available cargo and luggage load capacity is 650 lbs. (1400 – 750 (5 × 150) = 650 lbs.)
- (5) Determine the combined weight of luggage and cargo being loaded on the vehicle. That weight may not safely exceed the available cargo and luggage load capacity calculated in Step 4.

- (6) If your vehicle will be towing a trailer, load from your trailer will be transferred to your vehicle. Consult this manual to determine how this reduces the available cargo and luggage load capacity of your vehicle.

Example on your vehicle

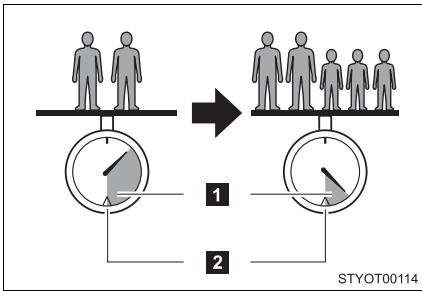

- 1** Cargo capacity
- 2** Total load capacity

When 2 people with the combined weight of A lb. (kg) are riding in your vehicle, which has a total load capacity of B lb. (kg), the available amount of cargo and luggage load capacity will be C lb. (kg) as follows:

$$B \text{ lb. (kg)} - A \text{ lb. (kg)} = C \text{ lb. (kg)}$$

In this condition, if 3 more passengers with the combined weight of D lb. (kg) get on, the available cargo and luggage load will be reduced E lb. (kg) as follows:

$$C \text{ lb. (kg)} - D \text{ lb. (kg)} = E \text{ lb. (kg)}$$

As shown in the above example, if the number of occupants increases, the cargo and luggage load will be reduced by an amount that equals the increased weight due to the additional occupants. In other words, if an increase in the number of occupants causes an excess of the total load capacity (combined weight of occupants plus cargo and luggage load), you must reduce the cargo and luggage on your vehicle.

 **CAUTION****■ Things that must not be carried in the luggage compartment**

The following things may cause a fire if loaded in the luggage compartment.

- Receptacles containing gasoline
- Aerosol cans

■ Storage precautions

- Do not stack anything behind the front seats higher than the seat-backs.

Such items may be thrown about and possibly injure people in the vehicle during sudden braking or in an accident.

- Do not place cargo or luggage in or on the following locations as the item may get under the brake or accelerator pedal and prevent the pedals from being depressed properly, block the driver's vision, or hit the driver or passengers, causing an accident.

- Driver's feet
- Front passenger or rear seats (when stacking items)
- Instrument panel
- Dashboard
- Auxiliary box or tray that has no lid

- Secure all items in the occupant compartment, as they may shift and injure someone during sudden braking, sudden swerving or an accident.

- Never allow anyone to ride in the rear deck. It is not designed for passengers. They should ride in their seats with their seat belts properly fastened. Otherwise, they are much more likely to suffer death or serious bodily injury, in the event of sudden braking, sudden swerving or an accident.

■ Capacity and distribution

- Do not exceed the maximum axle weight rating or the total vehicle weight rating.
- Even if the total load of occupant's weight and the cargo load is less than the total load capacity, do not apply the load unevenly. Improper loading may cause deterioration of steering or braking control which may cause death or serious injury.

2-5. Driving information

Vehicle load limits

Vehicle load limits include total load capacity, seating capacity, towing capacity and cargo capacity.

■ **Total load capacity: (→P. 644)**

Total load capacity means the combined weight of occupants, cargo and luggage.

■ **Seating capacity:**

▶ **Regular Cab models**

With front separated type seats—

2 occupants

With front bench type seat—

3 occupants

▶ **Double Cab and CrewMax models**

With front separated type seats—

5 occupants (Front 2, Rear 3)

With front bench type seat—

6 occupants (Front 3, Rear 3)

Seating capacity means the maximum number of occupants whose estimated average weight is 150 lb. (68 kg) per person.

Even if the number of occupants are within the seating capacity, do not exceed the total load capacity.

■ **Towing capacity: (→P. 265, 648)**

Towing capacity means the maximum gross trailer weight (trailer weight plus its cargo weight) that your vehicle is able to tow.

■ **Cargo capacity**

Cargo capacity may increase or decrease depending on the weight and the number of occupants.

■ **Total load capacity and seating capacity**

These details are also described on the tire and loading information label. (→P. 549)

 CAUTION**■ Overloading the vehicle**

Do not overload the vehicle.

It may not only cause damage to the tires, but also degrade steering and braking ability, resulting in an accident.

2-5. Driving information

Winter driving tips

Carry out the necessary preparations and inspections before driving the vehicle in winter. Always drive the vehicle in a manner appropriate to the prevailing weather conditions.

■ Pre-winter preparations

- Use fluids that are appropriate to the prevailing outside temperatures.
 - Engine oil
 - Engine coolant
 - Washer fluid
- Have a service technician inspect the level and specific gravity of battery electrolyte.
- Have the vehicle fitted with four snow tires or purchase a set of tire chains for the rear tires.

Ensure that all tires are the same size and brand, and that chains match the size of the tires.

■ Before driving the vehicle

Perform the following according to the driving conditions.

- Do not try to forcibly open a window, scrape an outside rear view mirror surface or move a wiper or outside rear view mirror that is frozen. Pour warm water over the frozen area to melt the ice. Wipe away the water immediately to prevent it from freezing.
- To ensure proper operation of the climate control system fan, remove any snow that has accumulated on the air inlet vents in front of the windshield.
- Remove any ice that has accumulated on the vehicle chassis.
- Periodically check for and remove any excess ice or snow that may have accumulated in the wheel well or on the brakes.

■ When driving the vehicle

Accelerate the vehicle slowly and drive at a reduced speed suitable to road conditions.

■ When parking the vehicle

Park the vehicle and move the shift lever to P without setting the parking brake. The parking brake may freeze up, preventing it from being released. If necessary, block the wheels to prevent inadvertent sliding or creeping.

■ Refueling (Flex-fuel vehicles)

Observe the following precautions when switching fuels, in order to maintain starting and driving performance.

- Do not change fuels when the fuel level is 1/4 or less.
- Always add at least 2.6 gal. (10 L) of fuel.
- After fulling up with fuel, warm up the engine or drive the vehicle for at least 5 minutes or 7 miles (11 km).
- Do not accelerate rapidly immediately after refueling.

Selecting tire chains

Use the correct tire chain size when mounting the snow chains. Chain size is regulated for each tire size.

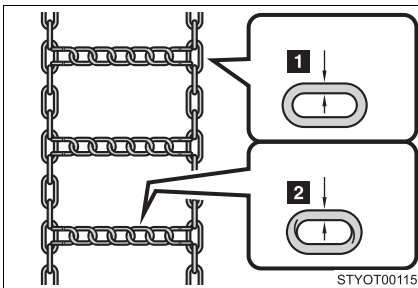

1 Side chain

0.2 in. (5 mm) in diameter

2 Cross chain

0.25 in. (6.3 mm) in diameter

Regulations on the use of snow chains

- Regulations regarding the use of tire chains vary according to location and type of road. Always check local regulations before installing chains.
- Install the chains on the rear tires.
- Retighten the chains after driving 1/4 - 1/2 mile (0.5 - 1.0 km).

■ Snow chain installation

Observe the following precautions when installing and removing chains.

- Install and remove tire chains in a safe location.
- Install tire chains on the rear tires only. Do not install tire chains on the front tires.
- Install tire chains following the instructions provided in the accompanying instructions.

CAUTION

■ Driving with snow tires

Observe the following precautions to reduce the risk of accidents.

Failing to do so may result in a loss of vehicle control and cause death or serious injury.

- Use tires of the size specified for your vehicle.
- Maintain the recommended level of air pressure.
- Do not drive in excess of 75 mph (120 km/h) regardless of the type of snow tires being used.
- Snow tires should be installed on all wheels.
- 4WD models:
Do not mix tires of different makes, models, tread patterns or treadwear.

 CAUTION**■ Driving with snow chains**

Observe the following precautions to reduce the risk of accidents. Failing to do so may result in the vehicle being unable to be driven safely, and may cause death or serious injury.

- Do not drive in excess of the speed limit specified for the tire chains being used or 30 mph (50 km/h), whichever is lower.
- Avoid driving on bumpy road surfaces or over potholes.
- Avoid sudden turns and braking.
- Slow down sufficiently before entering a curve to ensure that vehicle control is maintained.

 NOTICE**■ Repairing or replacing snow tires**

Request repairs of and obtain replacement snow tires from Toyota dealers or legitimate tire retailers.

This is because the removal and attachment of snow tires affects the operation of the tire pressure warning valves and transmitters.

■ Fitting tire chains

The tire pressure warning valves and transmitters may not function correctly when tire chains are fitted.

Trailer towing

Your vehicle is designed primarily as a passenger-and-load-carrying vehicle. Towing a trailer will have an adverse effect on handling, performance, braking, durability, and fuel consumption. For your safety and the safety of others, do not overload the vehicle or trailer.

To tow a trailer safely, use extreme care and drive the vehicle in accordance with the trailer's characteristics and operating conditions.

The vehicle stability and braking performance are affected by trailer stability, brake setting and performance, and the hitch.

Toyota warranties do not apply to damage or malfunction caused by towing a trailer for commercial purposes.

Contact your Toyota dealer for further information about additional requirements such as a towing kits, etc.

Weight limits

Confirm that the gross trailer weight, gross combination weight, gross vehicle weight, gross axle weight and trailer tongue load are all within the limits.

► Regular Cab models

Model code ^{*1}	Engine	Driving system	Bed type	GCWR	Towing capacity
GSK50L-TRADKA	4.0L V6 (1GR-FE) engine	2WD	Standard	10000 lb. (4535 kg)	5200 lb. (2355 kg)
GSK51L-THADKA			Long		5100 lb. (2310 kg)
UPK50L-TRTDKA	4.6L V8 (1UR-FE) engine	2WD	Standard	12500 lb. (5670 kg) ^{*2}	7500 lb. (3400 kg) ^{*2}
				14000 lb. (6350 kg) ^{*3}	9000 lb. (4080 kg) ^{*3}
Long			12500 lb. (5670 kg) ^{*2}	7400 lb. (3355 kg) ^{*2}	
			14000 lb. (6350 kg) ^{*3}	8900 lb. (4035 kg) ^{*3}	
UPK55L-TRTDKA		4WD	Standard	12500 lb. (5670 kg) ^{*2}	7200 lb. (3265 kg) ^{*2}
				14000 lb. (6350 kg) ^{*3}	8700 lb. (3945 kg) ^{*3}
Long	12500 lb. (5670 kg) ^{*2}		7100 lb. (3220 kg) ^{*2}		
	14000 lb. (6350 kg) ^{*3}		8600 lb. (3900 kg) ^{*3}		
UPK56L-THTDKA					

2-5. Driving information

Model code*1	Engine	Driving system	Bed type	GCWR	Towing capacity
USK50L-TRTDKA	5.7L V8 (3UR-FE) engine	2WD	Standard	14000 lb. (6350 kg) ^{*2}	8900 lb. (4035 kg) ^{*2}
				15500 lb. (7030 kg) ^{*3}	10400 lb. (4715 kg) ^{*3}
				15000 lb. (6800 kg) ^{*3,4}	9900 lb. (4490 kg) ^{*3,4}
USK51L-THTDKA		Long	14000 lb. (6350 kg) ^{*2}	8800 lb. (3990 kg) ^{*2}	
			16000 lb. (7255 kg) ^{*3}	10800 lb. (4895 kg) ^{*3}	
USK55L-TRTDKA		5.7L V8 (3UR-FE) engine	4WD	Standard	14000 lb. (6350 kg) ^{*2}
	15500 lb. (7030 kg) ^{*3}				10100 lb. (4580 kg) ^{*3}
	15000 lb. (6800 kg) ^{*3,4}				9600 lb. (4355 kg) ^{*3,4}
USK56L-THTDKA	Long		14000 lb. (6350 kg) ^{*2}	8600 lb. (3900 kg) ^{*2}	
			16000 lb. (7255 kg) ^{*3}	10500 lb. (4760 kg) ^{*3}	

Model code *1	Engine	Driving system	Bed type	GCWR	Towing capacity
USK55L-TRTDGA	5.7L V8 (3UR-FBE) engine	4WD	Standard	14000 lb. (6350 kg) ^{*2}	8700 lb. (3945 kg) ^{*2}
				15500 lb. (7030 kg) ^{*3}	10100 lb. (4580 kg) ^{*3}
				15000 lb. (6800 kg) ^{*3,4}	9600 lb. (4355 kg) ^{*3,4}
USK56L-THTDGA			Long	14000 lb. (6350 kg) ^{*2}	8600 lb. (3900 kg) ^{*2}
				16000 lb. (7255 kg) ^{*3}	10500 lb. (4760 kg) ^{*3}

*1: The model code is indicated on the Certification Label. (→P. 653)

*2: Without towing package

*3: With towing package

*4: P275/55R20 tires

► Double Cab models

Model code* ¹	Engine	Driving system	Bed type	GCWR	Towing capacity
GSK51L-CRASKA	4.0L V6 (1GR-FE) engine	2WD	Standard	10000 lb. (4535 kg)	4800 lb. (2175 kg)
UPK51L-CRTSKA	4.6L V8 (1UR-FE) engine	2WD	Standard	12500 lb. (5670 kg) ^{*2}	7200 lb. (3265 kg) ^{*2}
UPK51L-CRTLKA				14000 lb. (6350 kg) ^{*3}	8600 lb. (3900 kg) ^{*3}
				12500 lb. (5670 kg) ^{*2}	7100 lb. (3220 kg) ^{*2}
UPK52L-CHTSKA				Long	14000 lb. (6350 kg)
UPK56L-CRTSKA		4WD	Standard	12500 lb. (5670 kg) ^{*2}	6900 lb. (3130 kg) ^{*2}
UPK56L-CRTLKA				14000 lb. (6350 kg) ^{*3}	8300 lb. (3765 kg) ^{*3}
				12500 lb. (5670 kg) ^{*2}	6800 lb. (3085 kg) ^{*2}
UPK57L-CHTSKA				Long	14000 lb. (6350 kg)

Model code ^{*1}	Engine	Driving system	Bed type	GCWR	Towing capacity	
USK51L-CRTSKA	5.7L V8 (3UR-FE) engine	2WD	Standard	14000 lb. (6350 kg) ^{*2}	8600 lb. (3900 kg) ^{*2}	
				16000 lb. (7255 kg) ^{*3}	10600 lb. (4805 kg) ^{*3}	
USK51L-CRTLKA			Standard	14000 lb. (6350 kg) ^{*2}	8600 lb. (3900 kg) ^{*2}	
				16000 lb. (7255 kg) ^{*3}	10500 lb. (4760 kg) ^{*3}	
USK52L-CHTSKA		Long	16000 lb. (7255 kg)	10400 lb. (4715 kg)		
USK56L-CRTSKA			4WD	Standard	14000 lb. (6350 kg) ^{*2}	8300 lb. (3760 kg) ^{*2}
		16000 lb. (7255 kg) ^{*3}			10300 lb. (4670 kg) ^{*3}	
		USK56L-CRTLKA		Standard	14000 lb. (6350 kg) ^{*2}	8300 lb. (3760 kg) ^{*2}
					16000 lb. (7255 kg) ^{*3}	10200 lb. (4625 kg) ^{*3}
USK57L-CHTSKA		Long	16000 lb. (7255 kg)	10100 lb. (4580 kg)		
USK56L-CRTSGA	5.7L V8 (3UR-FBE) engine	4WD	Standard	14000 lb. (6350 kg) ^{*2}	8300 lb. (3760 kg) ^{*2}	
				16000 lb. (7255 kg) ^{*3}	10300 lb. (4670 kg) ^{*3}	
USK56L-CRTLGA			Standard	14000 lb. (6350 kg) ^{*2}	8300 lb. (3760 kg) ^{*2}	
				16000 lb. (7255 kg) ^{*3}	10200 lb. (4625 kg) ^{*3}	
USK57L-CHTSGA		Long	16000 lb. (7255 kg)	10100 lb. (4580 kg)		

*1: The model code is indicated on the Certification Label. (→P. 653)

*2: Without towing package

*3: With towing package

► CrewMax models

Model code *1	Engine	Driving system	Bed type	GCWR	Towing capacity
UPK51L-PSTSKA	4.6L V8 (1UR-FE) engine	2WD	Short	12500 lb. (5670 kg) ^{*2}	7000 lb. (3175 kg) ^{*2}
				14000 lb. (6350 kg) ^{*3}	8500 lb. (3855 kg) ^{*3}
UPK51L-PSTLKA				12500 lb. (5670 kg) ^{*2}	7000 lb. (3175 kg) ^{*2}
				14000 lb. (6350 kg) ^{*3}	8500 lb. (3855 kg) ^{*3}
UPK56L-PSTSKA		4WD		12500 lb. (5670 kg) ^{*2}	6700 lb. (3035 kg) ^{*2}
				14000 lb. (6350 kg) ^{*3}	8200 lb. (3715 kg) ^{*3}
UPK56L-PSTLKA				12500 lb. (5670 kg) ^{*2}	6700 lb. (3035 kg) ^{*2}
				14000 lb. (6350 kg) ^{*3}	8100 lb. (3670 kg) ^{*3}

Model code ^{*1}	Engine	Driving system	Bed type	GCWR	Towing capacity
USK51L-PSTSKA	5.7L V8 (3UR-FE) engine	2WD	Short	14000 lb. (6350 kg) ^{*2}	8400 lb. (3810 kg) ^{*2}
				16000 lb. (7255 kg) ^{*3}	10400 lb. (4715 kg) ^{*3}
14000 lb. (6350 kg) ^{*2}				8400 lb. (3810 kg) ^{*2}	
16000 lb. (7255 kg) ^{*3}				10400 lb. (4715 kg) ^{*3}	
USK56L-PSTSKA		4WD		14000 lb. (6350 kg) ^{*2}	8100 lb. (3670 kg) ^{*2}
				16000 lb. (7255 kg) ^{*3}	10100 lb. (4580 kg) ^{*3}
USK56L-PSTLKA				14000 lb. (6350 kg) ^{*2}	8100 lb. (3670 kg) ^{*2}
				16000 lb. (7255 kg) ^{*3}	10100 lb. (4580 kg) ^{*3}
USK56L-PSTSGA	5.7L V8 (3UR-FBE) engine	4WD	14000 lb. (6350 kg) ^{*2}	8100 lb. (3670 kg) ^{*2}	
			16000 lb. (7255 kg) ^{*3}	10100 lb. (4580 kg) ^{*3}	
USK56L-PSTLGA			14000 lb. (6350 kg) ^{*2}	8100 lb. (3670 kg) ^{*2}	
			16000 lb. (7255 kg) ^{*3}	10100 lb. (4580 kg) ^{*3}	

*1: The model code is indicated on the Certification Label. (→P. 653)

*2: Without towing package

*3: With towing package

- The gross trailer weight must never exceed towing capacity described in the table above.
- The gross combination weight must never exceed the GCWR described in the table above.

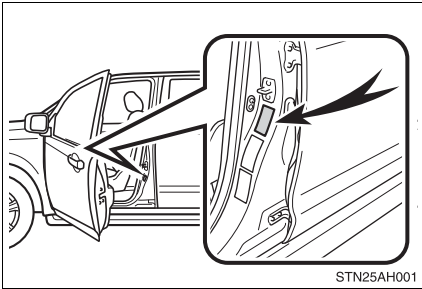

- The gross vehicle weight must never exceed the GVWR indicated the Certification Label.
- The gross axle weight on each axle must never exceed the GAWR indicated the Certification Label.

Towing related term

Towing related term	Meaning
GVWR (Gross Vehicle Weight Rating)	The maximum allowable gross vehicle weight. The gross vehicle weight is the total weight of the vehicle. When towing a trailer, it is the sum of the vehicle weight (including the occupants, cargo and any optional equipment installed on the vehicle) and the tongue load. (or the king pin weight)
GAWR (Gross Axle Weight Rating)	The maximum allowable gross axle weight. The gross axle weight is the load placed on each axle (front and rear).
GCWR (Gross Combination Weight Rating)	The maximum allowable gross combination weight. The gross combination weight is the sum of the total vehicle weight (including the occupants, cargo and any optional equipment installed on the vehicle) and the weight of the trailer being towed (including the cargo in the trailer).
Gross trailer weight	The sum of the trailer weight and the weight of the cargo in the trailer.

Towing related term	Meaning
Towing capacity	The maximum allowable gross trailer weight. Towing capacity is calculated considering base vehicle with necessary vehicle equipment and 150 pound driver. Additional optional equipment, passengers and cargo in the vehicle will reduce the towing capacity, gross trailer weight includes the trailer, cargo and necessary equipment for towing.
Tongue load	The load placed on the trailer hitch ball.
King pin weight	The load placed on the fifth wheel trailer hitch mount.

Trailer tongue load

- A recommended tongue load or king pin weight varies in accordance with the types of trailers or towing as described below.
- In order to ensure the recommended values shown below, the trailer must be loaded by referring to the following instructions.

1. Conventional Towing

The trailer cargo load should be distributed so that the tongue load is 9 to 11% of the gross trailer weight, not exceeding the following.

$$(\text{Tongue load} / \text{Gross trailer weight} \times 100 = 9 \text{ to } 11\%)$$

If the gross trailer weight is over 2000 lbs. (907 kg), it is necessary to use a sway control device with sufficient capacity.

If the gross trailer weight is over 5000 lbs. (2268 kg), it is necessary to use a weight distributing hitch with sufficient capacity.

If using a weight distributing hitch when towing, keep your vehicle level with the ground.

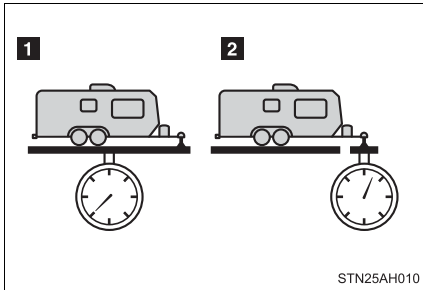

1 Gross trailer weight

2 Tongue load

2. Fifth wheel Towing

The king pin weight is 15 to 25% of the Gross Trailer weight.

(King pin weight/Gross trailer weight x 100 = 15 to 25%)

CrewMax models: Current fifth wheel trailer designs are not compatible with short bed.

The gross trailer weight and tongue load can be measured with platform scales found at a highway weighing station, building supply company, trucking company, junk yard, etc.

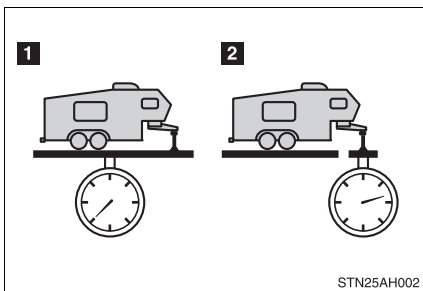

1 Gross trailer weight

2 King pin weight

Hitch

- If you wish to install a trailer hitch, contact your Toyota dealer.
- Use only a hitch that conforms to the gross trailer weight requirement.
- Follow the directions supplied by the hitch manufacturer.
- Lubricate the hitch ball and king pin with a light coat of grease.
- Remove the trailer hitch whenever you are not towing a trailer. After removing the hitch, seal any mounting hole in the vehicle body to prevent entry of any substances into the vehicle.

Bumper towing (vehicles with steel bumper only)

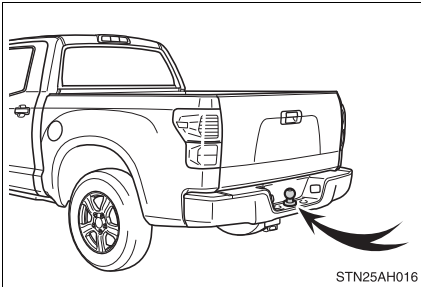

The rear bumper of your vehicle is equipped with a hole to install a trailer ball.

The maximum gross trailer weight: 5000 lb. (2268 kg)

The gross trailer weight (trailer weight plus cargo weight) when towing with the bumper must never exceed 5000 lb. (2268 kg).

Selecting trailer ball

Use the correct trailer ball for your application.

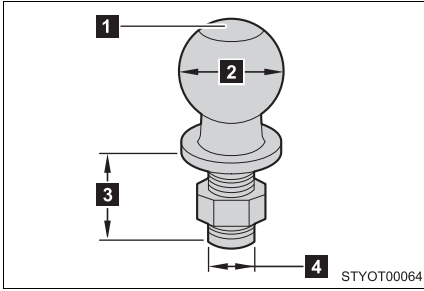

1 Trailer ball load rating

Matches or exceeds the gross trailer weight rating of the trailer.

2 Ball diameter

Matches the size of the trailer coupler. Most couplers are stamped with the required trailer ball size.

Trailer class	Typical trailer ball size
IV	2 5/16 in.
II and III	2 in.
I	1 7/8 in.

3 Shank length

Protrudes beyond the bottom of the lock washer and nut at least 2 threads.

4 Shank diameter

Matches the ball mount hole diameter size.

Connecting trailer lights

Use the wire harness stored in the rear end under body.

▶ 4 pin, 7 pin connectors

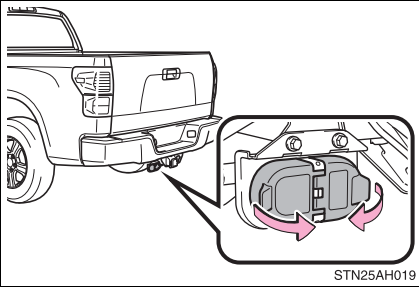

▶ 4 pin connector

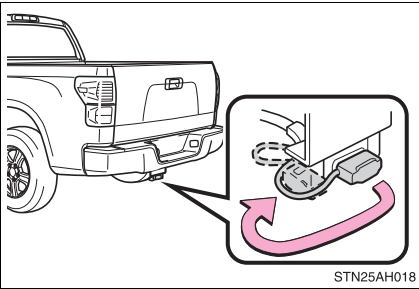

Trailer towing tips

Your vehicle will handle differently when towing a trailer. The three main causes of vehicle-trailer accidents are driver error, excessive speed and improper trailer loading. Keep the following in mind when towing.

- Speed limits for towing a trailer vary by state or province. Do not exceed the posted towing speed limit.
- Before starting out, check the trailer's light and the vehicle-trailer connections. Recheck after driving a short distance.
- Practice turning, stopping and reversing with the trailer attached in an area away from traffic until you become accustomed to the feel of the vehicle.
- Reversing with a trailer attached is difficult and requires practice. Grip the bottom of the steering wheel and move your hand to the left to move the trailer to the left. Move your hand to the right to move the trailer to the right. (This is generally opposite to reversing without a trailer attached.) Avoid sharp or prolonged turning. Have someone guide you when reversing to reduce the risk of an accident.
- As stopping distance is increased when towing a trailer, vehicle-to-vehicle distance should be increased. For each 10 mph (16 km/h) of speed, allow at least one vehicle and trailer length.
- Avoid sudden braking as you may skid, resulting in jackknifing and loss of control. This is especially true on wet or slippery surfaces.
- Avoid jerky starts or sudden acceleration.
- Avoid jerky steering and sharp turns, and slow down before making a turn.
- Note that when making a turn, the trailer wheels will be closer than the vehicle wheels to the inside of the turn. Compensate by making a larger than normal turning radius.

- Crosswinds and rough roads will adversely affect handling of your vehicle and trailer, causing sway. Periodically check the rear to prepare for being passed by large trucks or buses, which may cause your vehicle and trailer to sway. If swaying occurs, firmly grip the steering wheel, reduce speed immediately but gradually, and steer straight ahead. Never increase speed. If you make no extreme correction with the steering or brakes, your vehicle and trailer will stabilize.
- Take care when passing other vehicles. Passing requires considerable distance. After passing a vehicle, do not forget the length of your trailer, and be sure you have plenty of room before changing lanes.
- In order to maintain engine braking efficiency when driving on a long steep downgrade, do not use the transmission in D. Transmission shift range position must be in 5 in the S mode (6-speed models) or in 4 in the S mode (5-speed models).
- Due to the added load of the trailer, your vehicle's engine may overheat on hot days (at temperatures over 85°F [30°C]) when driving up a long or steep grade. If the engine coolant temperature gauge indicates overheating, immediately turn off the air conditioning (if in use), pull your vehicle off the road and stop in a safe spot. (→P. 634)
- Always place wheel blocks under both the vehicle and the trailer wheels when parking. Apply the parking brake firmly, and put the transmission in P. Avoid parking on a slope, but if unavoidable, do so only after performing the following:

STEP 1 Apply the brakes and keep them applied.

STEP 2 Have someone place wheel blocks under both the vehicle and trailer wheels.

STEP 3 When the wheel blocks are in place, release the brakes slowly until the blocks absorb the load.

STEP 4 Apply the parking brake firmly.

STEP 5 Shift into P and turn off the engine.

● When restarting after parking on a slope:

STEP 1 With the transmission in P, start the engine. Be sure to keep the brake pedal pressed.

STEP 2 Shift into D or R (if reversing).

STEP 3 Release the parking brake and brake pedal, and slowly pull or back away from the wheel blocks. Stop and apply the brakes.

STEP 4 Have someone retrieve the blocks.

■ Service connector for towing brake controller (with towing package)

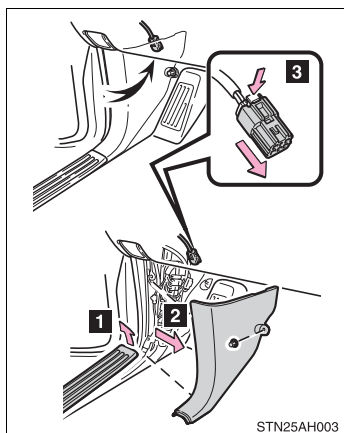

Your vehicle is equipped with a service connector for the trailer brake controller as shown.

Access the service connector.

- 1** Remove the scuff plate.
- 2** Remove the clip (screw type) and trim board.
- 3** Remove the connector cover.

■ Matching trailer ball height to trailer coupler height

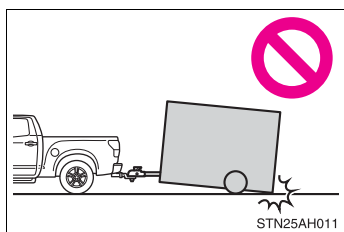

No matter which class of tow hitch applies, for a safe trailer hookup, the trailer ball setup on must be the proper height for the coupler on the trailer.

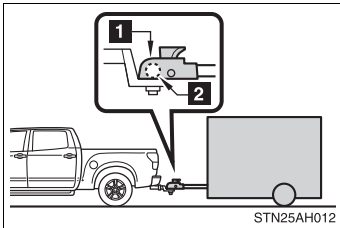

1 Coupler

2 Trailer ball

■ Before towing

Check that the following conditions are met:

- Ensure that your vehicle's tires are properly inflated. (→P. 666)
- Trailer tires should be inflated according to the trailer manufacturer's recommendation.
- All trailer lights work to be legal.
- All lights work each time you connect them.
- The trailer ball is set up at the proper height for the coupler on the trailer.
- The vehicle remains level when a loaded or unloaded trailer is hitched. Do not drive if the vehicle is not level, and check for improper tongue load, overloading, worn suspension, or other possible causes.
- The trailer cargo is securely loaded.
- The rear view mirrors conform to all applicable federal, state/provincial or local regulations. If they do not, install rear view mirrors appropriate for towing purposes.
- Depress TOW/HAUL button (if equipped)

■ Break-in schedule

If your vehicle is new or equipped with any new power train components (such as an engine, transmission, differential and wheel bearing), Toyota recommends that you do not tow a trailer until it has been driven for over 500 miles (800 km).

After the vehicle has been driven for over 500 miles (800 km), you can start towing. However, drive the vehicle at a speed of less than 50 mph (80 km/h) when towing a trailer for another 500 miles (800 km). In addition, avoid full throttle acceleration.

■ Maintenance

- If you tow a trailer, your vehicle will require more frequent maintenance due to the additional load. (See “Scheduled Maintenance Guide” or “Owner’s Manual Supplement”.)
- Retighten the fixing bolts of the towing ball and bracket after approximately 600 miles (1000 km).

CAUTION

■ Trailer towing precautions

Follow all the instructions described in this section. Failure to do so could cause an accident resulting in death or serious injury.

- To tow a trailer safely, use extreme care and drive the vehicle in accordance with the trailer’s characteristics and operating conditions.
The vehicle stability and braking performance are affected by trailer stability, brake setting and performance, and the hitch.
- Do not exceed the towing capacity, GVWR, GCWR or GAWR.
- Adjust the tongue weight or king pin weight to within the appropriate range. (→P. 273)

■ To avoid accident or injury

- Speed limit for towing a trailer vary by state or province. Do not exceed the posted towing speed limit.
- Do not exceed the trailer hitch assembly weight, gross vehicle weight, gross axle weight and trailer tongue load capacities.
- Do not use cruise control when you are towing.
- Slow down and downshift before descending steep or long downhill grades. Do not make sudden downshifts.
- Avoid holding the brake pedal down too long or applying the brakes too frequently. This could cause the brakes to overheat and result in reduced braking efficiency.
- Do not tow the vehicle with the temporary spare tire installed.

 **CAUTION****■ Hitch**

Trailer hitch assemblies have different weight capacities established by the hitch manufacturer. Even though the vehicle may be physically capable of towing a higher weight, the operator must determine the maximum weight rating of the particular hitch assembly and never exceed the maximum weight rating specified for the trailer-hitch. Exceeding the maximum weight rating set by the trailer-hitch manufacturer can cause an accident resulting in death or serious personal injuries.

■ When towing a trailer

- If the gross trailer weight exceeds 1000 lb. (453 kg), trailer brakes are required. Toyota recommends trailers with brakes that conform to all applicable federal and state/provincial regulations.
- Never tap into your vehicle's hydraulic system, as this will lower the vehicle's braking effectiveness.
- Never tow a trailer without using a safety chain securely attached to both the trailer and the vehicle. If damage occurs to the coupling unit or hitch ball, there is danger of the trailer wandering into another lane.

 **NOTICE****■ When installing a trailer hitch**

Use only the position recommended by your Toyota dealer. Do not install the trailer hitch on the bumper; this may cause body damage.

■ Safety chain

A safety chain must always be used between the towing vehicle and the trailer. Leave sufficient slack in the chain for turns. The chain should cross under the trailer tongue to prevent the tongue from dropping to the ground in the case that it becomes damaged or separated. For the correct safety chain installation procedure, ask your Toyota dealer.

■ Do not directly splice trailer lights

Directly splicing trailer lights may damage your vehicle's electrical system and cause a malfunction.



NOTICE

■ **When towing a fifth wheel trailer**

Be careful not to hit the cabin or deck by the trailer while making a sharp turn.

2-5. Driving information

Dinghy towing

Your vehicle is not designed to be dinghy towed (with 4 wheels on the ground) behind a motor home.

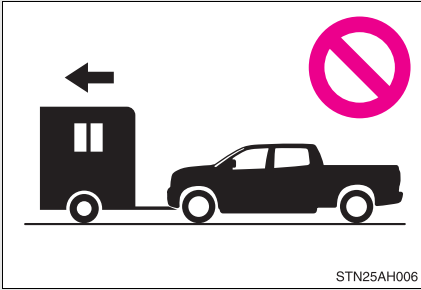

NOTICE

■ To avoid serious damage to your vehicle

Do not tow your vehicle with four wheels on the ground.

3-1. Using the air conditioning system and defogger

Automatic air conditioning system	288
Manual air conditioning system	297
Outside rear view mirror defoggers and front windshield wiper de-icer (if equipped on Regular Cab and Double Cab models)	305
Back window, outside rear view mirror defoggers and front windshield wiper de-icer (if equipped on CrewMax models)	307

3-2. Using the audio system

Audio system types	310
Using the radio	314
Using the CD player	322
Playing MP3 and WMA discs	331
Operating an iPod®	339
Operating a USB memory	345
Optimal use of the audio system	352
Using the AUX adapter	356
Using the steering wheel audio switches	358

3-3. Using the Bluetooth® audio system

Bluetooth® audio system	361
Using the Bluetooth® audio system	364
Operating a Bluetooth® enabled portable player	369
Setting up a Bluetooth® enabled portable player	371
Bluetooth® audio system setup	376

3-4. Using the rear audio/video system

Rear seat entertainment system	377
Using the DVD player (DVD video)	386
Using the DVD player (video CD)	395
Using the DVD player (audio CD/CD text)	398
Using the DVD player (MP3 discs)	400
Using the video mode	403
Changing the Setup Menu settings	405

Interior and exterior features

3

3-5. Using the hands-free phone system (for cellular phone)

Hands-free phone system features.....	413
Using the hands-free phone system	417
Making a phone call	425
Setting a cellular phone ...	429
Security and system setup	433
Using the phone book	436

3-6. Using the interior lights

Interior lights list	442
• Personal/interior light main switch	443
• Personal/interior lights ...	444
• Cargo lamp main switch	446

3-7. Using the storage features

List of storage features	447
• Glove boxes	449
• Console box	450
• Card holder	453
• Map holder	456
• Pen holder	459
• Tissue pocket.....	461
• Overhead console.....	463
• Front cup holders	464
• Rear cup holders	466
• Bottle holders	467
• Auxiliary boxes.....	469
• Storage box	471

3-8. Other interior features

Sun visors	474
Vanity mirrors	475
Clock	476
Outside temperature display	477
Ashtray	479
Cigarette lighter.....	481
Power outlets (12V DC) ...	482
Power outlets (115V AC)	487
Seat heaters.....	491
Seat heaters and ventilators	493
Armrest (CrewMax models only)	495
Seatback table	496
Floor mat.....	497
Luggage compartment features	498
Garage door opener.....	501
Compass.....	506

3-1. Using the air conditioning system and defogger Automatic air conditioning system*

Airflow and outlets are automatically adjusted according to the temperature setting.

► **Control panel**

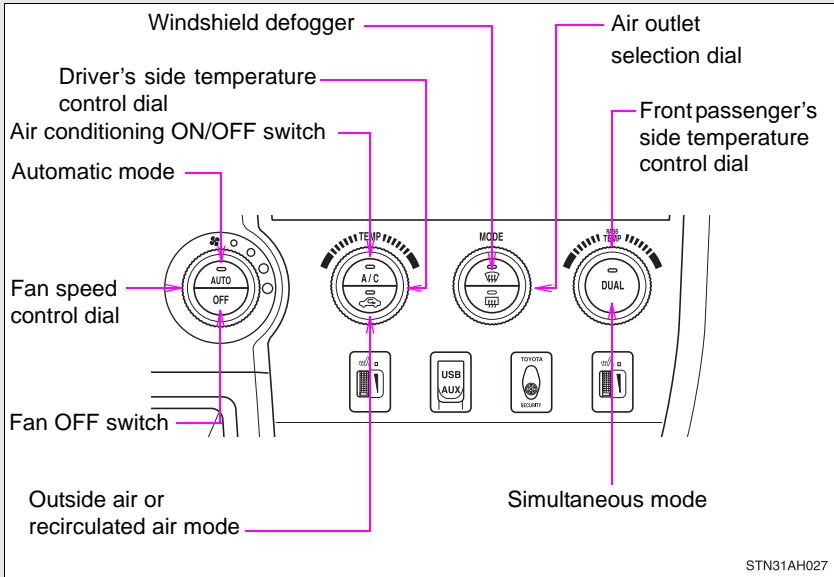

*: If equipped

► Display

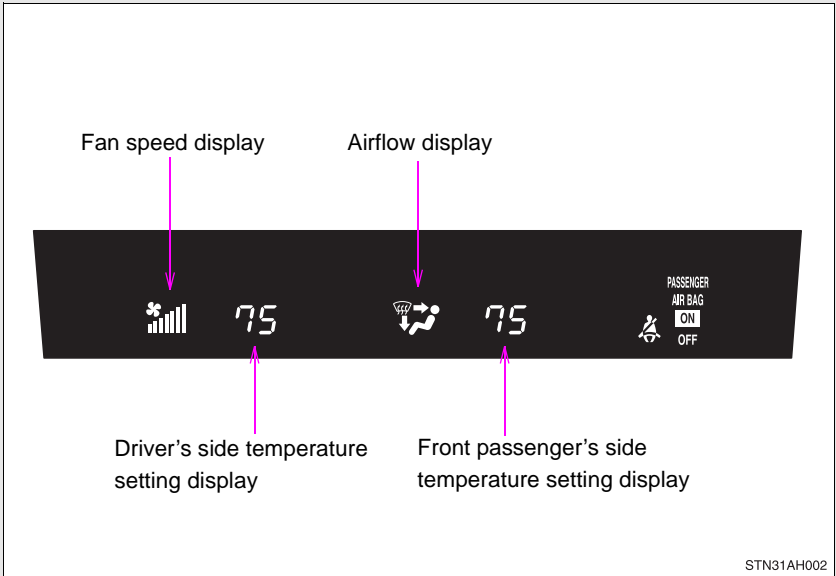

Using the automatic mode

STEP 1 Press .

The air conditioning system will begin to operate. Air outlets and fan speed are automatically adjusted according to the temperature setting.

STEP 2 Turn the temperature control dial clockwise (warm) or counterclockwise (cool).

The temperature for the driver and front passenger seats can be set separately.

Adjusting the settings

■ Adjusting the temperature setting

Turn the temperature control dial clockwise (warm) or counter-clockwise (cool).

The air conditioning system switches between individual and simultaneous modes each time  is pressed.

- Individual mode (the indicator on  is on)

The temperature for the driver and front passenger seats can be adjusted separately.

- Simultaneous mode (the indicator on  is off)

The driver's side temperature control dial can be used to adjust the temperature for driver and front passenger seats.

■ Adjusting the fan speed

Turn the fan speed control dial clockwise (increase) or counter-clockwise (decrease).

The fan speed is shown on the display. (7 levels)

Press  to turn the fan off.

■ Changing the air outlets

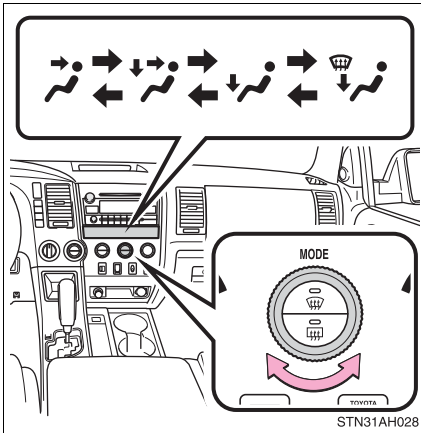

Turn the air outlet selection dial.

The air outlets switch each time either side of air outlet selection dial is turned.

Air flow as shown according to the mode selected.

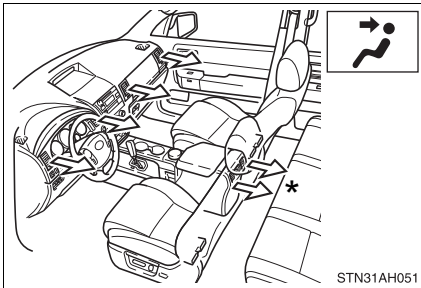

When the dial is set to , air flows to the upper body.

*: CrewMax models only

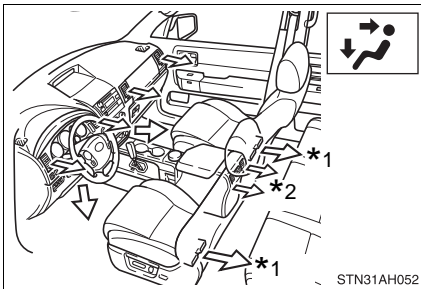



When the dial is set to , air flows to the upper body and feet.

*1: Double Cab and CrewMax models only

*2: CrewMax models only

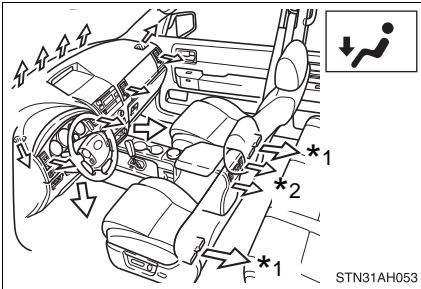
3-1. Using the air conditioning system and defogger



When the dial is set to , air flows to the feet.

*1: Double Cab and CrewMax models only

*2: CrewMax models only

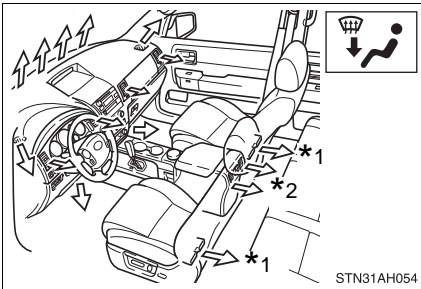



When the dial is set to , air flows to the feet and the windshield defogger operates.

*1: Double Cab and CrewMax models only

*2: CrewMax models only

■ Switching between outside air and recirculated air modes

Press .

The mode switches between  (outside air mode) and  (recirculated air mode) each time the switch is pressed.

Defogging the windshield

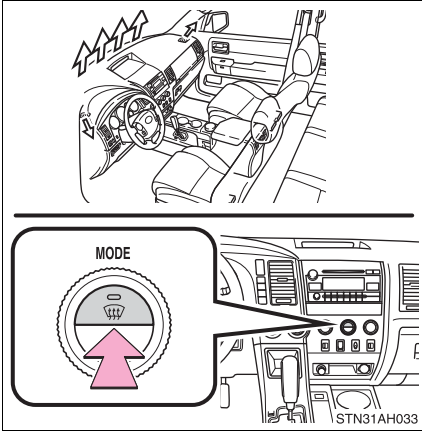

Press .

The indicator comes on.

The air conditioning system control operates automatically.

Recirculated air mode will automatically switch to outside air mode.

Adjusting the position and opening and closing the air outlets

► Driver side outlets

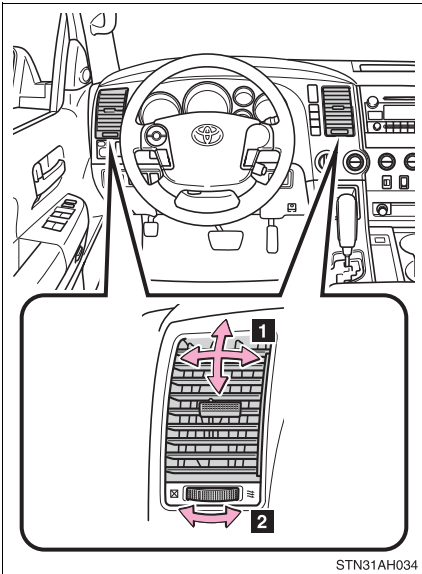

1 Direct air flow to the left or right, up or down.

2 Turn the knob to open or close the vent.

3-1. Using the air conditioning system and defogger

► Front passenger side outlets

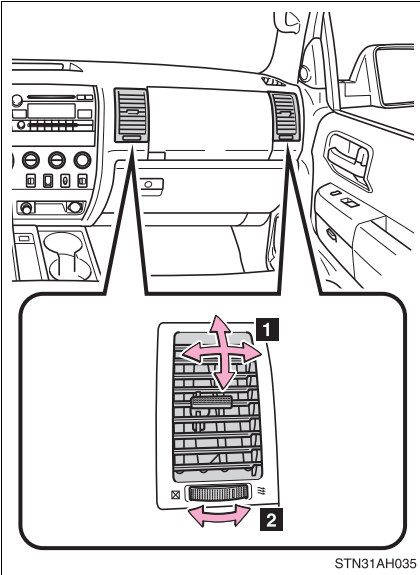

STN31AH035

- 1 Direct air flow to the left or right, up or down.
- 2 Turn the knob to open or close the vent.

► Rear outlets (CrewMax models only)

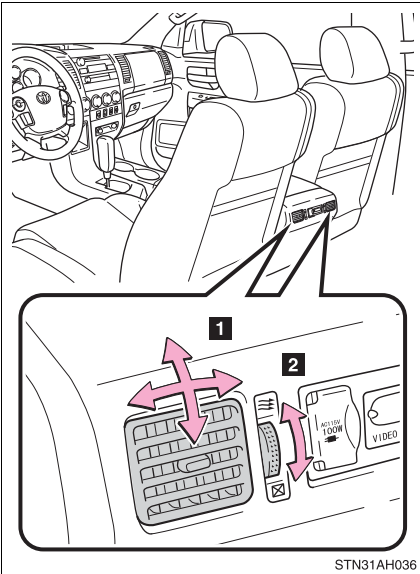

STN31AH036

- 1 Direct air flow to the left or right, up or down.
- 2 Turn the knob to open or close the vent.

■ Using the automatic mode

Fan speed is adjusted automatically in accordance with the temperature setting and ambient conditions. As a result, the following may occur.

- Immediately after the switch is pressed, the fan may stop for a while until warm or cool air is ready to flow.
- Cool air may flow to the area around the upper body when the heater is on.

■ Using the system in recirculated air mode

The windows will fog up more easily if the recirculated air mode is used for an extended period.

■ Switching between outside air and recirculated air modes

Recirculated air mode or outside air mode may be automatically switched to in accordance with the temperature setting and the inside temperature.

■ Window defogger feature

Recirculated air mode may automatically switch to  (outside air) mode in situations where the windows need to be defogged.

■ When outside temperature approaches 32°F (0°C)

The air conditioning system may not operate even when  is pressed.

■ When the indicator on flashes

Press  and turn off the air conditioning system before turning it on once more. There may be a problem in the air conditioning system if the indicator continues to flash. Turn the air conditioning system off and have it inspected by your Toyota dealer.

■ Air conditioning odors

- During use, various odors from inside and outside the vehicle may enter into and accumulate in the air conditioning system. This may then cause odor to be emitted from the vents.
- To reduce potential odors from occurring:
 - It is recommended that the air conditioning system be set to outside air mode prior to turning the vehicle off.
 - The start timing of the blower may be delayed for a short period of time immediately after the air conditioning system is started in automatic mode.

CAUTION

■ To prevent the windshield from fogging up

Do not use  during cool air operation in extremely humid weather. The difference between the temperature of the outside air and that of the windshield can cause the outer surface of the windshield to fog up, blocking your vision.

NOTICE

■ To prevent battery discharge

Do not leave the air conditioning system on longer than necessary when the engine is stopped.

3-1. Using the air conditioning system and defogger Manual air conditioning system*

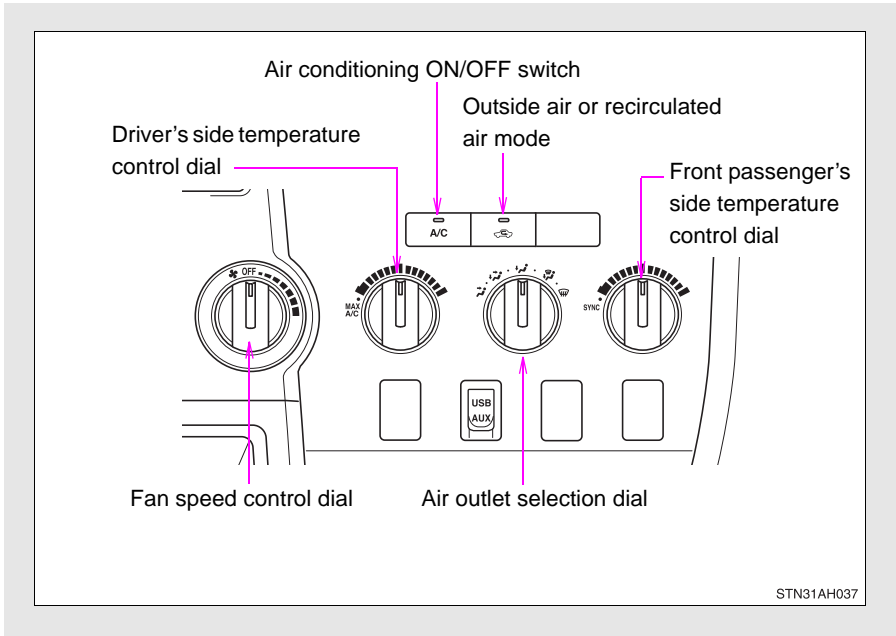

Adjusting the settings

■ Adjusting the temperature setting

▶ Driver's side temperature control dial

Turn the temperature control dial clockwise (warm) or counter-clockwise (cool).

If  is not pressed, the system will blow ambient temperature air or heated air.

For quick cooling, turn the temperature control dial to the MAX A/C position.

The air conditioning will automatically turn on and the air intake selector will be set to recirculated air mode.

*: If equipped

► Front passenger's side temperature control dial

Turn the temperature control dial clockwise (warm) or counter-clockwise (cool).

● Individual mode

When the front passenger's side temperature control dial in a position other than the SYNC position, the temperature for the driver and front passenger seats can be adjusted separately.

● Simultaneous mode

When the front passenger's side temperature control dial in SYNC position, turn the driver's side temperature control dial can be used to adjust the temperature for driver and front passenger seats.

■ Adjusting the fan speed

Turn the fan speed control dial clockwise (increase) or counter-clockwise (decrease).

Set the dial to OFF to turn the fan off.

■ Changing the air outlets

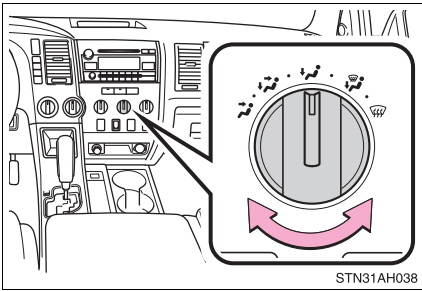

Turn the air outlet selection dial.

The air outlets switch each time either side of air outlet selection dial is turned.

Air flow as shown according to the mode selected.

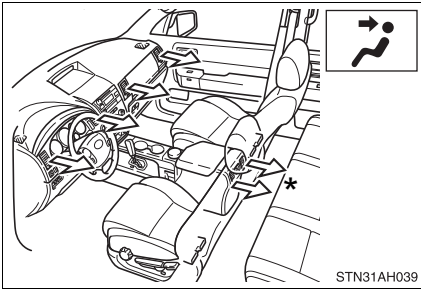

When the dial is set to , air flows to the upper body.

*: CrewMax models only

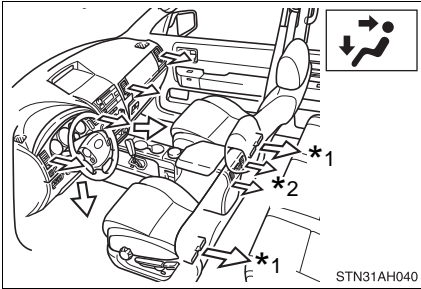

When the dial is set to , air flows to the upper body and feet.

*1: Double Cab and CrewMax models only

*2: CrewMax models only

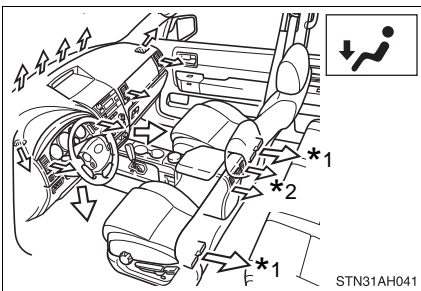



When the dial is set to , air flows to the feet.

*1: Double Cab and CrewMax models only

*2: CrewMax models only

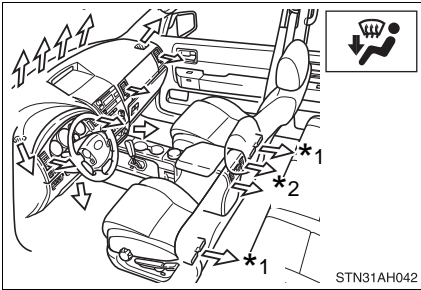
3-1. Using the air conditioning system and defogger



When the dial is set to , air flows to the feet and the windshield defogger operates.

The air intake selector is automatically set to outside air mode. To return the recirculated air mode,

press .

*1: Double Cab and CrewMax models only

*2: CrewMax models only

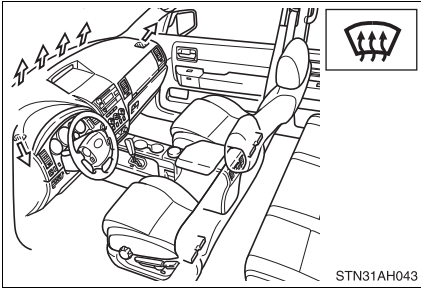

When the dial is set to , air flows to the windshield and side windows.



The air intake selector is automatically set to outside air mode.

In this position, the air intake selector cannot be changed to the recirculated air mode, press



■ Switching between outside air and recirculated air modes

Press .

The mode switches between  (outside air mode) and  (recirculated air mode) each time the switch is pressed.

■ **If the ambient temperature drops while using the recirculated air mode**

The air intake mode automatically changes from recirculated air mode to outside air mode after a few minutes.

To cancel this function:

Press and hold  for longer than 2 seconds.

To reactivate this function:

Turn the engine switch to the LOCK or ACC position.

Adjusting the position and opening and closing the air outlets

► Driver side outlets

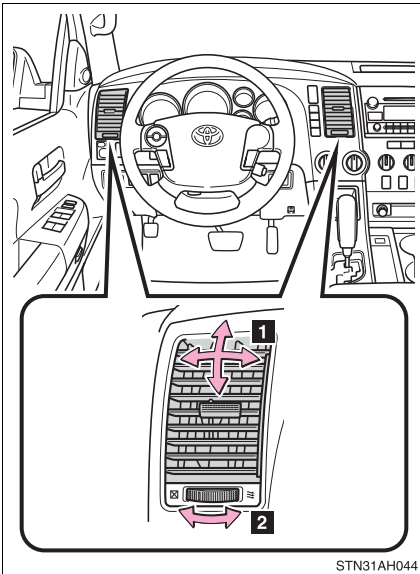

STN31AH044

- 1 Direct air flow to the left or right, up or down.
- 2 Turn the knob to open or close the vent.

► Front passenger side outlets

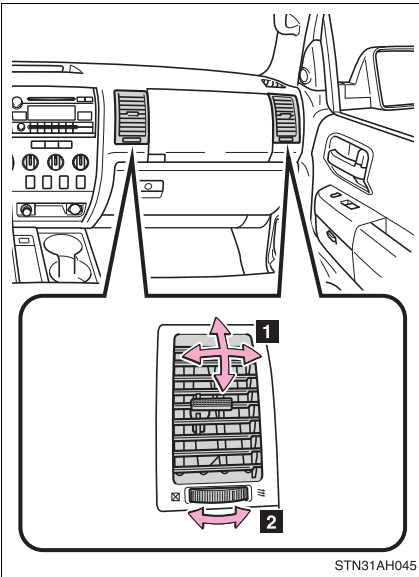

- 1 Direct air flow to the left or right, up or down.
- 2 Turn the knob to open or close the vent.

► Rear outlets (CrewMax models only)

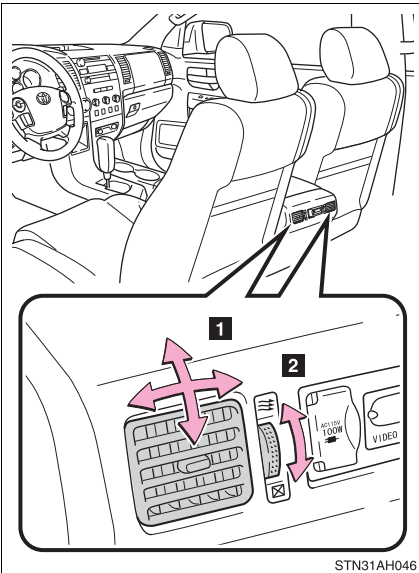

- 1 Direct air flow to the left or right, up or down.
- 2 Turn the knob to open or close the vent.

■ For quick clearing of the windshield and side windows

Press  to turn the air conditioning on.

■ Using the system in recirculated air mode

The windows will fog up more easily if the recirculated air mode is used for an extended period.

■ When outside air temperature approaches 32°F (0°C)

The air conditioning system may not operate even when  is pressed.

■ When is selected for the air outlets used

For your driving comfort, air flowing to the feet may be warmer than air flowing to the upper body depending on the position of the temperature control dial.

■ When the indicator on flashes

Press  and turn off the air conditioning system before turning it on once more. There may be a problem in the air conditioning system if the indicator continues to flash. Turn the air conditioning system off and have it inspected by your Toyota dealer.

■ Air conditioning odors

- During use, various odors from inside and outside the vehicle may enter into and accumulate in the air conditioning system. This may then cause odor to be emitted from the vents.
- To reduce potential odors from occurring:
It is recommended that the air conditioning system be set to outside air mode prior to turning the vehicle off.

 CAUTION

■ **To prevent the windshield from fogging up**

Do not set the air outlet selection dial to  during cool air operation in extremely humid weather. The difference between the temperature of the outside air and that of the windshield can cause the outer surface of the windshield to fog up, blocking your vision.

 NOTICE

■ **To prevent battery discharge**

Do not leave the air conditioning system on longer than necessary when the engine is stopped.

3-1. Using the air conditioning system and defogger

Outside rear view mirror defoggers and front windshield wiper de-icer (if equipped on Regular Cab and Double Cab models)

Clear the outside rear view mirrors using the defogger.

► Vehicles with an automatic air conditioning system

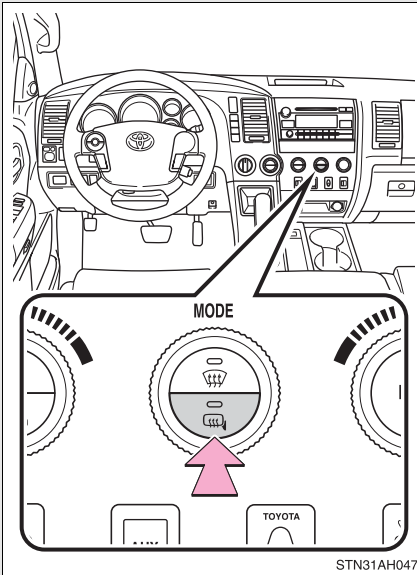

On/off

Press the button to turn on the outside rear view mirror defoggers. The indicator will come on. The defoggers will automatically turn off after about 15 minutes. Pressing the button again also turns the defoggers off.

► Vehicles with a manual air conditioning system

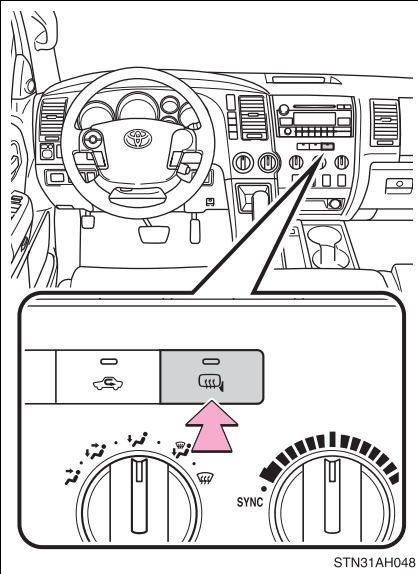

On/off

Press the button to turn on the outside rear view mirror defoggers. The indicator will come on. The defoggers will automatically turn off after about 15 minutes. Pressing the button again also turns the defoggers off.

■ **The defogger can be operated when**

The engine switch is in the ON position.

■ **The front windshield wiper de-icer (if equipped)**

Turning the outside rear view mirror defoggers on will turn the front windshield wiper de-icer on.

⚠ CAUTION

■ **Outside rear view mirror defoggers**

The surfaces of the outside rear view mirrors become hot. Do not touch them to prevent from burning yourself.

■ **When the front windshield wiper de-icer is on (if equipped)**

Do not touch the glass at the lower part of the windshield or to the side of the front pillars as the surfaces can become very hot and burn you.

3-1. Using the air conditioning system and defogger

Back window, outside rear view mirror defoggers and front windshield wiper de-icer (if equipped on CrewMax models)

Clear the back window using the defogger.

► Vehicles with an automatic air conditioning system

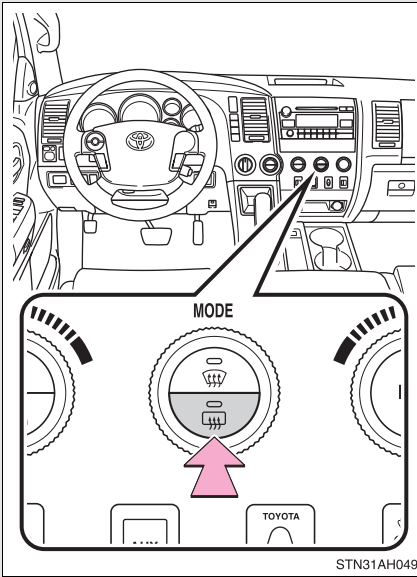

On/off

Press the button to turn on the back window defogger. The indicator will come on. The defoggers will automatically turn off after about 15 minutes. Pressing the button again also turns the defogger off.

► Vehicles with a manual air conditioning system

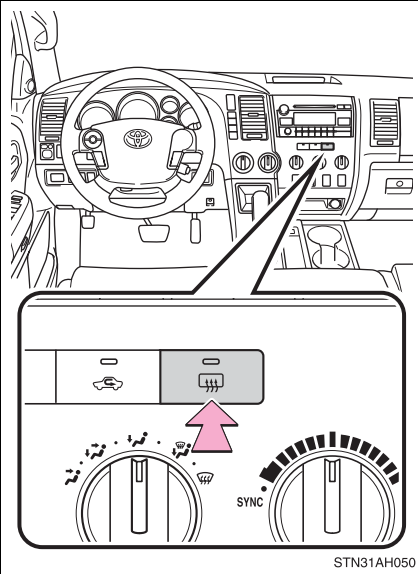

On/off

Press the button to turn on the back window defogger. The indicator will come on. The defoggers will automatically turn off after about 15 minutes. Pressing the button again also turns the defogger off.

■ **The defogger can be operated when**

The engine switch is in the ON position.

■ **Outside rear view mirror defoggers (if equipped)**

Turning the back window defogger on will turn outside rear view mirror defoggers on.

■ **The front windshield wiper de-icer (if equipped)**

Turning the back window defogger on will turn the front windshield wiper de-icer on.

 CAUTION

■ **Back window defogger**

The surface of the back window becomes hot. Do not touch it to prevent from burning yourself.

■ **Outside rear view mirror defoggers (if equipped)**

The surfaces of the outside rear view mirrors become hot. Do not touch them to prevent from burning yourself.

■ **When the front windshield wiper de-icer is on (if equipped)**

Do not touch the glass at the lower part of the windshield or to the side of the front pillars as the surfaces can become very hot and burn you.

3-2. Using the audio system

Audio system types

► With navigation system

Owners of models equipped with a navigation system should refer to the “Navigation System Owner’s Manual”.

► Without navigation system

Type A: CD player with changer controller and AM/FM radio

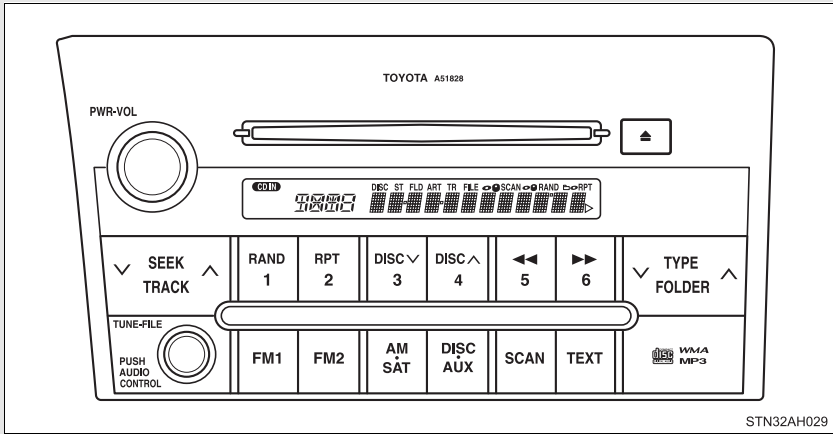

Type B: CD player with changer and AM/FM radio

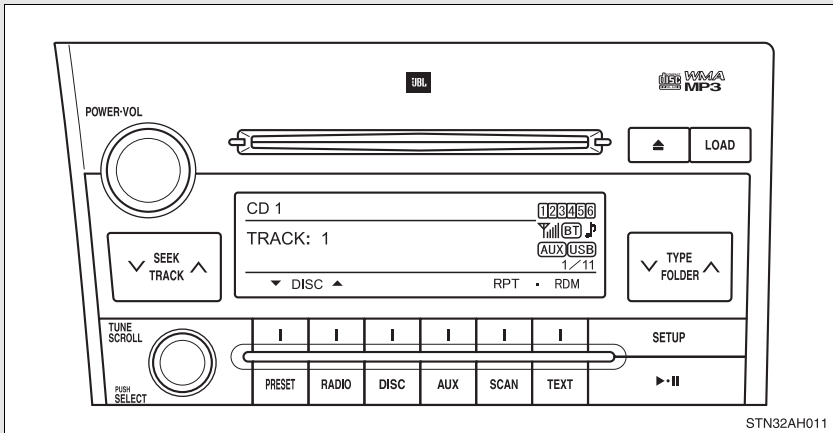

Type C: CD player with changer controller and AM/FM radio

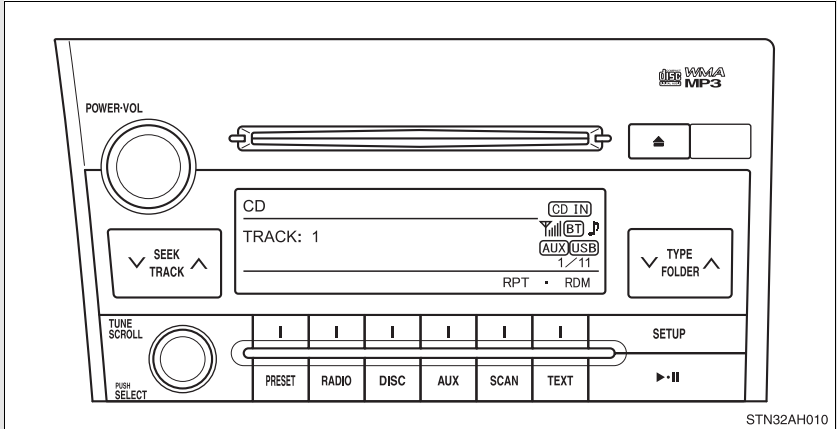



Title	Page
Using the radio	P. 314
Using the CD player	P. 322
Playing MP3 and WMA discs	P. 331
Operating an iPod®	P. 339
Operating a USB memory	P. 345
Optimal use of the audio system	P. 352
Using the AUX adapter	P. 356
Using the steering wheel audio switches	P. 358

Language settings (type B and C)

The language used for all voice guidance, voice recognition and messages may be changed.

STEP 1 Press  .

STEP 2 Press  that corresponds to “MORE”.

STEP 3 Press  that corresponds to “LANG”.

STEP 4 Press  that corresponds to the desired language.

- ▶ For vehicles sold in the U.S.A.
“ENG” (English) or “ESP” (Spanish)
- ▶ For vehicles sold in Canada
“ENG” (English) or “FRAN” (French)

■ Using cellular phones

Interference may be heard through the audio system's speakers if a cellular phone is being used inside or close to the vehicle while the audio system is operating.

 **CAUTION****■ For vehicles sold in U.S.A. and Canada****● Part 15 of the FCC Rules**

FCC Warning:

Any unauthorized changes or modifications to this equipment will void the user's authority to operate this device.

● Laser products

- Do not take this unit apart or attempt to make any changes yourself. This is an intricate unit that uses a laser pickup to retrieve information from the surface of compact discs. The laser is carefully shielded so that its rays remain inside the cabinet. Therefore, never try to disassemble the player or alter any of its parts since you may be exposed to laser rays and dangerous voltages.
- This product utilizes a laser. Use of controls or adjustments or performance of procedures other than those specified herein may result in hazardous radiation exposure.

 **NOTICE****■ To prevent battery discharge**

Do not leave the audio system on longer than necessary with the engine off.

■ To avoid damaging the audio system

Take care not to spill drinks or other fluids over the audio system.

3-2. Using the audio system

Using the radio

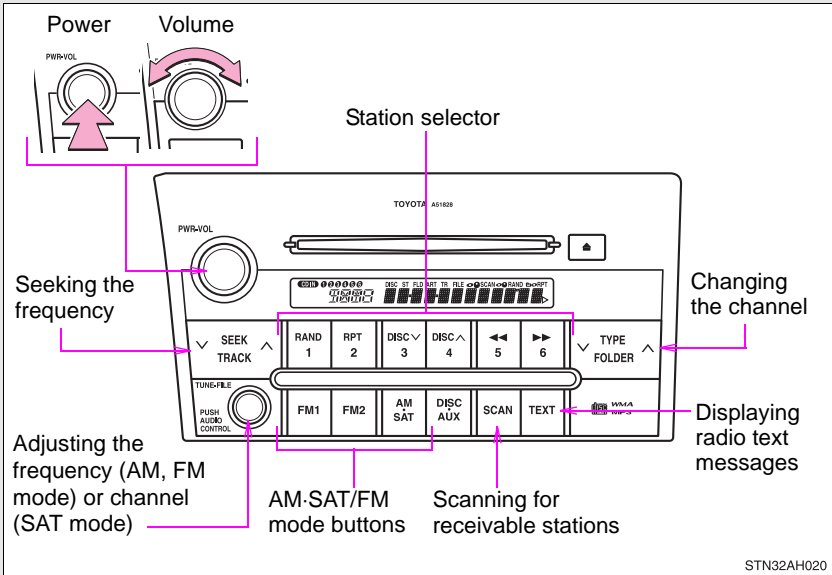

► Type A



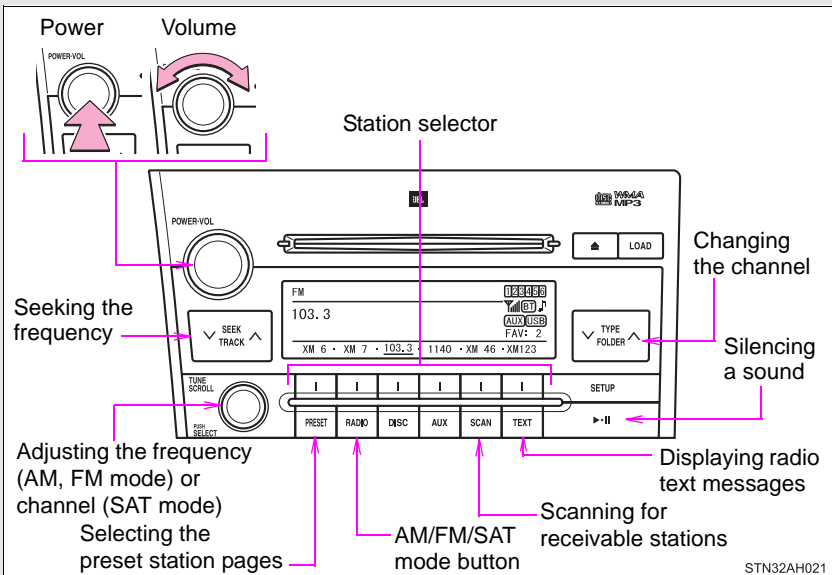



► Type B and C



Setting station presets (excluding XM[®] Satellite Radio)

STEP 1 Search for desired stations by turning  or  or

pressing “^” or “v” on .

STEP 2 Press and hold a button (from  to  or one of ) until you hear a beep.

Type B and C:

Each time  is pressed, station pages are changed. There are a total of 6 pages.

Scanning radio stations (excluding XM[®] Satellite Radio)

■ Scanning the preset radio stations

STEP 1 Press and hold  until you hear a beep.

Preset stations will be played for 5 seconds each.

STEP 2 When the desired station is reached, press  again.

■ Scanning all radio stations within range

STEP 1 Press .

All the stations with reception will be played for 5 seconds each.

STEP 2 When the desired station is reached, press  again.

■ Displaying radio text messages (for type B and C, FM mode only)

When a new radio text message is received, “MSG” is shown on the display. To display the message, press .



If the text continues past the end of the display, “▶” is displayed. Press and hold  until you hear a beep.

Text messages are not displayed while driving.

XM[®] Satellite Radio (if equipped)

■ Receiving XM[®] Satellite Radio

STEP 1 Press  or .



The display changes as follows each time  or  is pressed.

▶ Type A

AM → SAT1 → SAT2 → SAT3

▶ Type B and C



AM → FM → SAT

STEP 2 Turn  or  to select the desired channel in all the

categories or press “^” or “v” on  to select the desired channel in the current category.

■ Setting XM[®] Satellite Radio channel presets

Select the desired channel. Press and hold a button (from  to

 or one of ) until you hear a beep.

Type B and C:

Each time  is pressed, station pages are changed. There are a total of 6 pages.

■ Changing the channel category

Press “^” or “v” on .

■ Scanning XM[®] Satellite Radio channels

- Scanning channels in the current category

STEP 1 Press .

STEP 2 When the desired channel is reached, press  again.

- Scanning the preset channels

STEP 1 Press and hold  until you hear a beep.

STEP 2 When the desired channel is reached, press  again.

■ Displaying text information

Press .

Each time is pressed, the display changes in the following order:

▶ Type A

Channel name → Title (song/program title) → Name (artist name/feature)
→ Channel number.

▶ Type B and C

Title (song/program title) → Title (song/program title)/Name (artist name/feature).

■ When the battery is disconnected

All preset stations are erased. (type A only)

■ Reception sensitivity

- Objects, especially metal objects, such as cargo, a camper, or a truck rack, may adversely affect the reception of XM[®] Satellite Radio.
- Maintaining perfect radio reception at all times is difficult due to the continually changing position of the antenna, differences in signal strength and surrounding objects, such as trains, transmitters, etc.

■ XM[®] Satellite Radio

An XM[®] Satellite Radio is a tuner designed exclusively to receive broadcasts provided under a separate subscription. Availability is limited to the 48 contiguous states and 10 Canadian provinces.

● XM[®] subscriptions

For detailed information about XM[®] Satellite Radio or to subscribe:



U.S.A. —

Visit on the web at www.xmradio.com or call 1-800-967-2346.

Canada —

Visit on the web at www.xmradio.ca or call 1-877-438-9677.

● Radio ID

You will need the radio ID when activating XM[®] service or reporting a problem. Select “CH000” using  or , and the receiver's 8-character ID number will appear.

● Satellite tuner

The tuner supports only Audio Services (Music and Talk) and the accompanying Text Information of XM[®] Satellite Radio.

■ **If XM[®] Satellite Radio does not operate normally**

If a problem occurs with the XM[®] tuner, a message will appear on the display. Refer to the table below to identify the problem, and take the suggested corrective action.

ANTENNA or CHECK ANTENNA	The XM [®] antenna is not connected. Check whether the XM [®] antenna cable is attached securely.
	There is a short-circuit in the antenna or the surrounding antenna cable. See a Toyota certified dealer.
UPDATING	You have not subscribed to XM [®] Satellite Radio. The radio is being updated with the latest encryption code. Contact XM [®] Satellite Radio for subscription information. When a contract is canceled, you can choose the "CH000" and all free-to-air channels.
	The premium channel you selected is not authorized. Wait for about 2 seconds until the radio returns to the previous channel or "CH001". If it does not change automatically, select another channel. If you want to listen to the premium channel, contact XM [®] Satellite Radio.
NO SIGNAL	The XM [®] signal is too weak at the current location. Wait until your vehicle reaches a location with a stronger signal.
LOADING	The unit is acquiring audio or program information. Wait until the unit has received the information.
OFF AIR or CHANNEL OFF AIR	The channel you selected is not broadcasting any programming. Select another channel.
-----	There is no song/program title or artist name/feature associated with the channel at this time. No action needed.

The channel you selected is no longer available. Wait for about 2 seconds until the radio returns to the previous channel or "CH001". If it does not change automatically, select another channel.

Contact the XM[®] Listener Care Center at 1-800-967-2346 (U.S.A.) or 1-877-438-9677 (Canada)

■ Certifications for the radio tuner

This equipment has been tested and found to comply with the limits for a class B digital device, pursuant to Part 15 of the FCC Rules. These limits are designed to provide reasonable protection against harmful interference in a residential installation. This equipment generates, uses and can radiate radio frequency energy and, if not installed and used in accordance with the instructions, may cause harmful interference to radio communications. However, there is no guarantee that interference will not occur in a particular installation.

If this equipment does cause harmful interference to radio or television reception, which can be determined by turning the equipment off and on, the user is encouraged to try to correct the interference by trying one or more of the following:

- Reorienting or relocating the receiving antenna.
- Increasing the separation between the equipment and receiver.
- Connecting the equipment into an outlet on a circuit different from that to which the receiver is connected.
- Consulting the dealer or an experienced radio/TV technician for help.



NOTICE

■ To prevent damage, remove the antenna in the following cases.

- The antenna will touch the ceiling of a garage.
- A cover will be put on the vehicle.

3-2. Using the audio system Using the CD player

▶ Type A

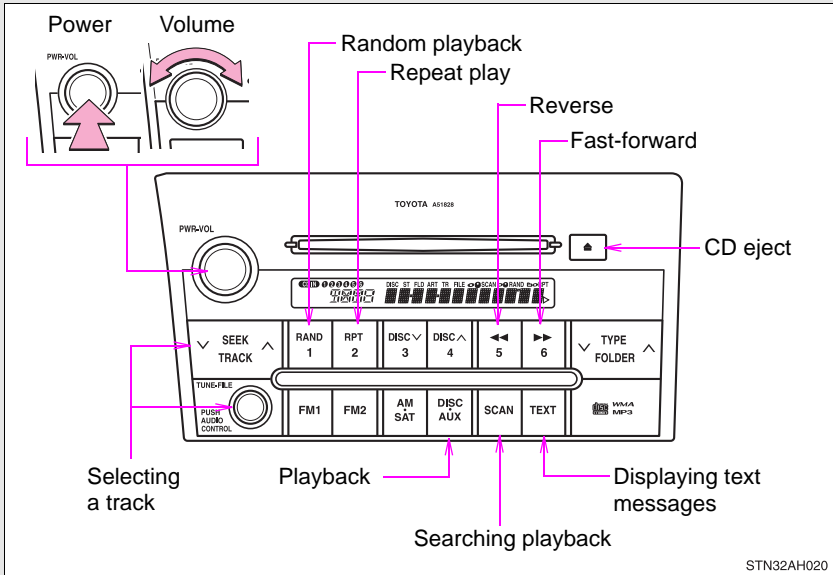

▶ Type B and C

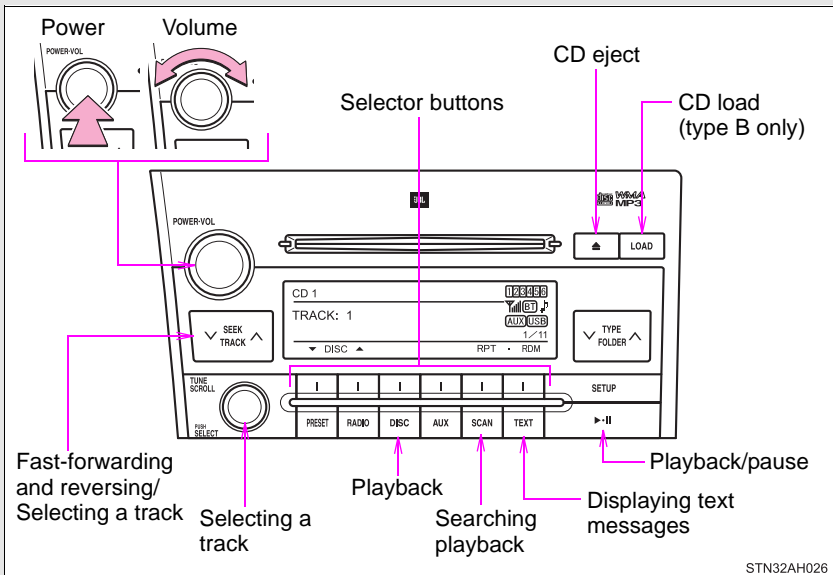

Loading CDs

■ Loading a CD (type A and C)

Insert a CD.

■ Loading a CD (type B)

STEP 1 Press .

STEP 2 When the indicator on the slot turns from amber to green, insert a CD.

■ Loading multiple CDs (type B only)

STEP 1 Press and hold until you hear a beep.

STEP 2 When the indicator on the slot turns from amber to green, insert a CD.

The indicator on the slot turns to amber when the CD is inserted.

STEP 3 When the indicator on the slot turns from amber to green again, insert the next CD.

Repeat the procedure for the remaining CDs.

To cancel, press . If you do not insert a disc within 15 seconds, loading will be canceled automatically.

Ejecting CDs

■ Ejecting a CD (type A and C)

Press  and remove the CD.

■ Ejecting a CD (type B)

STEP 1 To select the CD to be ejected, press  that corresponds to “▲” or “▼”.



The selected CD number is shown on the display.

STEP 2 Press  and remove the CD.

■ Ejecting all the CDs (type B only)

Press and hold  until you hear a beep, and then remove the CDs.

Selecting a track

Turn  or  or press “^” or “v” on  to select the desired track.

Fast-forwarding and reversing tracks

▶ Type A

Press  or .

▶ Type B and C

Press and hold “^” or “v” on .

Scanning tracks

STEP 1 Press .

The first ten seconds of each track will be played.

To cancel, press  again.

STEP 2 Press  again when the desired track is reached.

Selecting a CD (type B only)

■ Selecting a CD to play

Press  that corresponds to “▲” or “▼”.

■ Scanning loaded CDs

STEP 1 Press and hold  until you hear a beep.

The first ten seconds of the first track on each CD will be played.

To cancel, press  again.



STEP 2 Press  again when the desired CD is reached.

Playing and pausing tracks (type B and C)

Press .

Random playback

■ Current CD

Press  or  that corresponds to “RDM”.

Songs are played in random order.

To cancel, press the button again.

■ All CDs (type B only)



Press  that corresponds to “RDM” twice.

Tracks on all loaded CDs are played in random order.

To cancel, press the button again.

Repeat play

■ Repeating a track

Press  or  that corresponds to “RPT”.

To cancel, press the button again.

■ Repeating all of the tracks on a CD (type B only)

Press  that corresponds to “RPT” twice.

To cancel, press the button again.

Switching the display

Press .

Each time is pressed, the display changes in the following order:

▶ Type A

Track no./Elapsed time → CD title → Track name.

▶ Type B and C

Track title → Track name/Artist name → Track name/Elapsed time.

■ Display (type A only)

Up to 12 characters can be displayed at a time.

If there are 13 characters or more, pressing and holding for 1 second or more will display the remaining characters.
A maximum of 24 characters can be displayed.



If is pressed for 1 second or more again or has not been pressed for 6 seconds or more, the display will return to the first 12 characters.

Depending on the contents recorded, the characters may not be displayed properly or may not be displayed at all.

■ Error messages

“CD CHECK”: This indicates a problem either with the CD or inside the player. The CD may be dirty, damaged or inserted up-side down.

“WAIT” or “PLEASE WAIT”: Operation has stopped due to a high temperature inside the player. Wait for a while and then

press  or . Contact your Toyota dealer if the CD still cannot be played back.

■ Discs that can be used

Discs with the marks shown below can be used.

Playback may not be possible depending on the recording format or disc features, or due to scratches, dirt or deterioration.



CDs with copy-protection features may not be used.

■ CD player protection feature

To protect the internal components, playback is automatically stopped when a problem is detected while the CD player is being used.

■ If CDs are left inside the CD player or in the ejected position for extended periods

CDs may be damaged and may not play properly.

■ Lens cleaners

Do not use lens cleaners. Doing so may damage the CD player.

 NOTICE

■ CDs and adapters that cannot be used

Do not use the following types of CDs, 3 in. (8 cm) CD adapters or Dual Discs.

Doing so may damage the CD player and/or the CD insert/eject function.

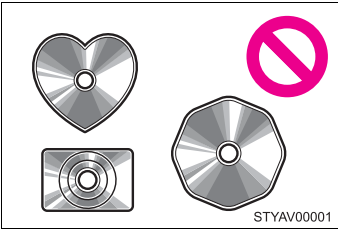

- CD player with changer and AM/FM radio: CDs that have a diameter that is not 4.7 in. (12 cm)

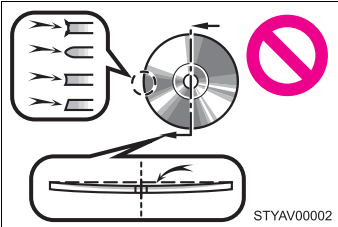

- Low-quality and deformed CDs

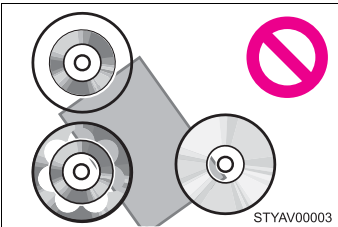

- CDs with a transparent or translucent recording area

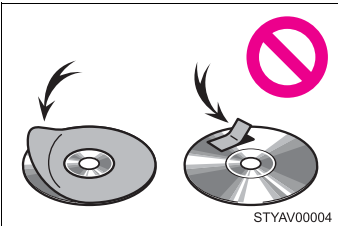

- CDs that have had tape, stickers or CD-R labels attached to them, or that have had the label peeled off

 NOTICE

■ **CD player precautions**

Failure to follow the precautions below may result in serious damage to the CDs or the player itself.

- Do not insert anything other than CDs into the CD slot.
- Do not apply oil to the CD player.
- Store CDs away from direct sunlight.
- Never try to disassemble any part of the CD player.

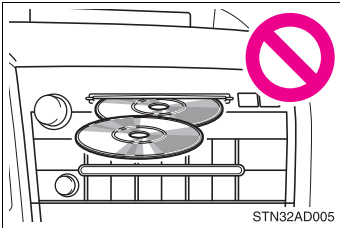

- Do not insert more than one CD at a time.

3-2. Using the audio system Playing MP3 and WMA discs

▶ Type A

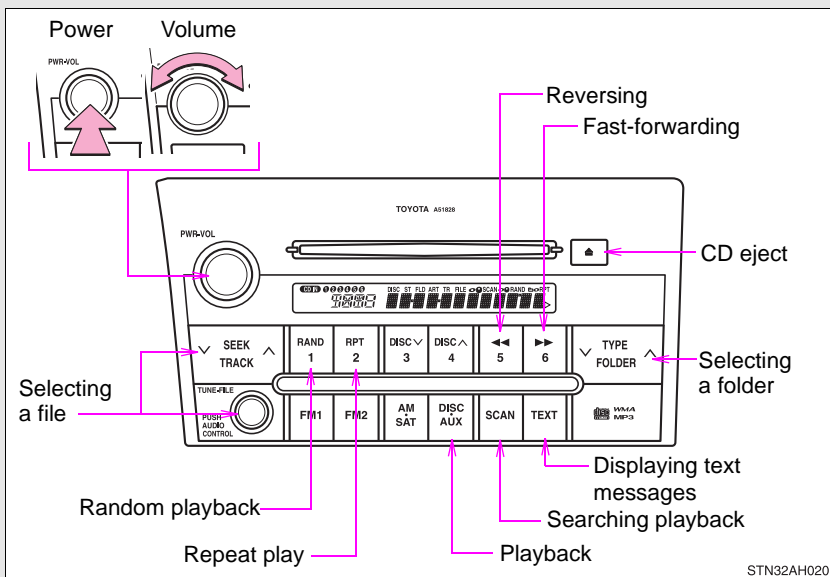

▶ Type B and C

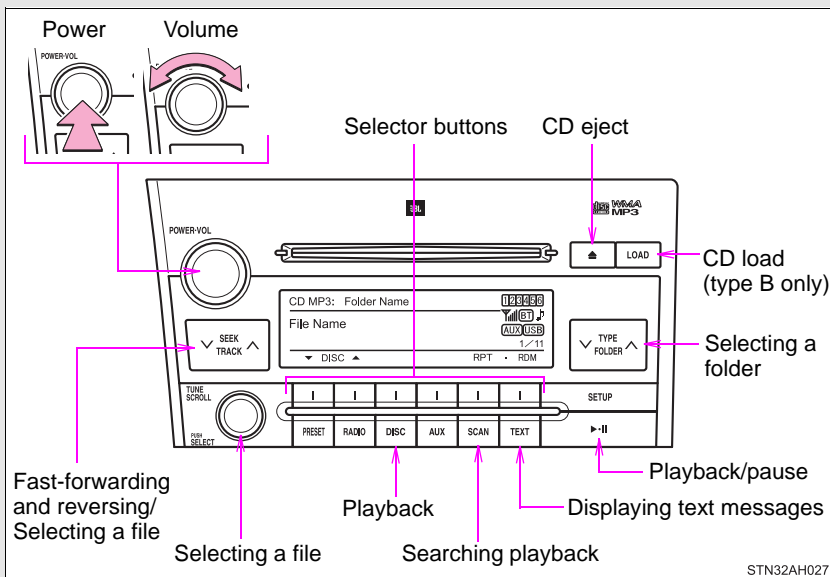

Loading and ejecting MP3 and WMA discs

→P. 323

Selecting MP3 and WMA discs (type B only)

→P. 325

Selecting and scanning a folder

■ Selecting folders one at a time

Press “^” or “v” on  to select the desired folder.

■ Scanning the first file of all the folders

STEP 1 Press and hold  until you hear a beep.

The first ten seconds of the first file in each folder will be played.



STEP 2 When the desired folder is reached, press  again.

■ Returning to the first folder

Press and hold “v” on  until you hear a beep.

Selecting and scanning files

■ Selecting one file at a time

Turn  or  or press “^” or “v” on  to select the desired file.

■ Selecting the desired file by cueing the files in the folder

Press .

When the desired file is reached, press  once again.

Fast-forwarding and reversing files

▶ Type A

Press  or .

▶ Type B and C



Press and hold “^” or “v” on .

Playing and pausing files (type B and C)

Press .

Random playback

■ Playing files from a particular folder in random order

Press  or  that corresponds to “RDM”.

To cancel, press the button again.



■ Playing all of the files on a disc in random order (type B only)

Press  that corresponds to “RDM” twice.

To cancel, press the button again.

Repeat play

■ Repeating a file

Press  or  that corresponds to “RPT”.

To cancel, press the button again.

■ Repeating all of the files in a folder

▶ Type A

Press and hold  until you hear a beep.

To cancel, press the button again.

▶ Type B and C

Press  that corresponds to “RPT” twice.

To cancel, press the button again.

■ Repeating all of the files in a disc (type B only)

Press  that corresponds to “RPT” three times.

To cancel, press the button again.

Switching the display

Press .

Each time  is pressed, the display changes in the following order:

▶ Type A

Folder no./File no./Elapsed time → Folder name → File name → Album title (MP3 only) → Track title → Artist name.

▶ Type B and C

Track title → Track title/Artist name → Track title/Album name → Track title/Elapsed time.



■ Display

→P. 327

■ Error messages

“CD CHECK”: This indicates a problem either with the CD or inside the player. The CD may be dirty, damaged or inserted up-side down.

“WAIT” or “PLEASE WAIT”: Operation has stopped due to a high temperature inside the player. Wait for a while and then

press  or . Contact your Toyota dealer if the CD still cannot be played.

■ Discs that can be used

→P. 328

■ CD player protection feature

→P. 328

■ If CDs are left inside the CD player or in the ejected position for extended periods

→P. 328

■ Lens cleaners

→P. 328

■ MP3 and WMA files

MP3 (MPEG Audio LAYER3) is a standard audio compression format.

Files can be compressed to approximately 1/10 of their original size by using MP3 compression.

WMA (Windows Media[®] Audio) is a Microsoft[®] audio compression format.

This format compresses audio data to a size smaller than that of the MP3 format.

There is a limit to the MP3 and WMA file standards and to the media/formats recorded by them that can be used.

● MP3 file compatibility

- Compatible standards
MP3 (MPEG1 LAYER3, MPEG2 LSF LAYER3)
- Compatible sampling frequencies
MPEG1 LAYER3: 32, 44.1, 48 (kHz)
MPEG2 LSF LAYER3: 16, 22.05, 24 (kHz)
- Compatible bit rates (compatible with VBR)
MPEG1 LAYER3: 64, 80, 96, 112, 128, 160, 192, 224, 256, 320 (kbps)
MPEG2 LSF LAYER3: 64, 80, 96, 112, 128, 144, 160 (kbps)
- Compatible channel modes: stereo, joint stereo, dual channel and monaural

● WMA file compatibility

- Compatible standards
WMA Ver. 7, 8, 9
- Compatible sampling frequencies
32, 44.1, 48 (kHz)
- Compatible bit rates (only compatible with 2-channel playback)
Ver. 7, 8: CBR 48, 64, 80, 96, 128, 160, 192 (kbps)
Ver. 9: CBR 48, 64, 80, 96, 128, 160, 192, 256, 320 (kbps)

● Compatible media

Media that can be used for MP3 and WMA playback are CD-Rs and CD-RWs.

Playback in some instances may not be possible, depending on the status of the CD-R or CD-RW. Playback may not be possible or the audio may jump if the disc is scratched or marked with fingerprints.

● Compatible disc formats

The following disc formats can be used.

- Disc formats: CD-ROM Mode 1 and Mode 2
CD-ROM XA Mode 2, Form 1 and Form 2
- File formats: ISO9660 Level 1, Level 2, (Romeo, Joliet)
MP3 and WMA files written in any format other than those listed above may not play correctly, and their file names and folder names may not be displayed correctly.

Items related to standards and limitations are as follows.

- Maximum directory hierarchy: 8 levels
- Maximum length of folder names/file names: 32 characters
- Maximum number of folders: 192 (including the root)
- Maximum number of files per disc: 255

● File names

The only files that can be recognized as MP3/WMA and played are those with the extension .mp3 or .wma.

● Multi-sessions

As the audio system is compatible with multi-sessions, it is possible to play discs that contain MP3 and WMA files. However, only the first session can be played.

● ID3 and WMA tags

ID3 tags can be added to MP3 files, making it possible to record the track title and artist name, etc.

The system is compatible with ID3 Ver. 1.0, 1.1, and Ver. 2.2, 2.3 ID3 tags. (The number of characters is based on ID3 Ver. 1.0 and 1.1.)

WMA tags can be added to WMA files, making it possible to record the track title and artist name in the same way as with ID3 tags.

● MP3 and WMA playback

When a disc containing MP3 or WMA files is inserted, all files on the disc are first checked. Once the file check is finished, the first MP3 or WMA file is played. To make the file check finish more quickly, we recommend you do not write in any files other than MP3 or WMA files or create any unnecessary folders.

If the discs contain a mixture of music data and MP3 or WMA format data, only music data can be played.

● Extensions

If the file extensions .mp3 and .wma are used for files other than MP3 and WMA files, they will be mistakenly recognized and played as MP3 and WMA files. This may result in large amounts of interference and damage to the speakers.

● Playback

- To play MP3 files with steady sound quality, we recommend a fixed bit rate of 128 kbps and a sampling frequency of 44.1 kHz.
- CD-R or CD-RW playback may not be possible in some instances, depending on the characteristics of the disc.
- There is a wide variety of freeware and other encoding software for MP3 and WMA files on the market, and depending on the status of the encoding and the file format, poor sound quality or noise at the start of playback may result. In some cases, playback may not be possible at all.
- When files other than MP3 or WMA files are recorded on a disc, it may take more time to recognize the disc. In some cases, playback may not be possible at all.
- Microsoft[®], Windows[®], and Windows Media[®] are the registered trademarks of Microsoft Corporation in the U.S. and other countries.



NOTICE

■ **CDs and adapters that cannot be used (→P. 329)**

■ **CD player precautions (→P. 330)**

3-2. Using the audio system Operating an iPod®*

Connecting an iPod® enables you to enjoy music from the vehicle speakers.

■ Connecting an iPod®

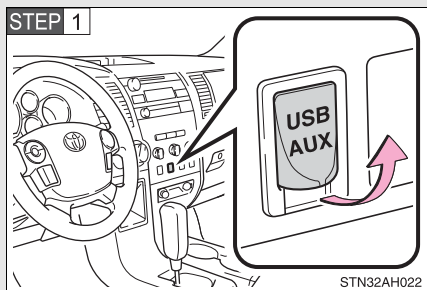

Open the cover and connect an iPod® using an iPod® cable.

STEP 2 Press **AUX**.

■ Control panel

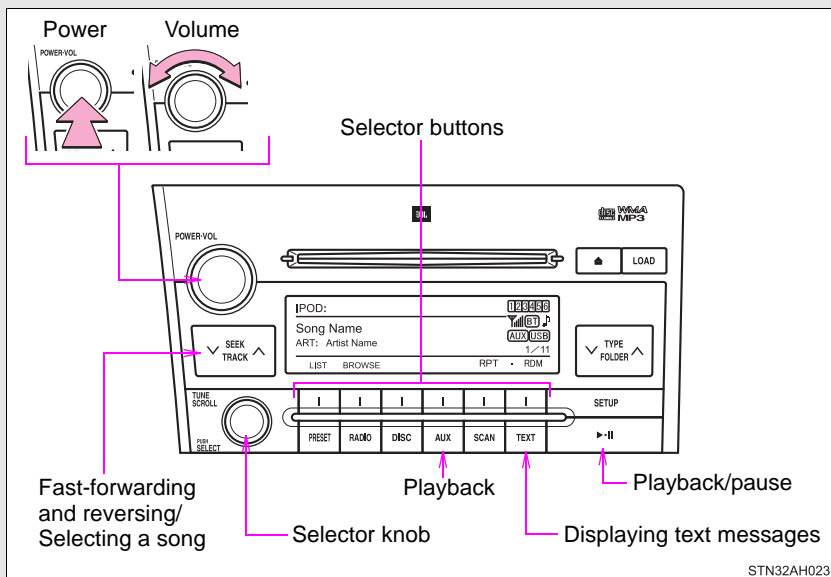

*: If equipped

Selecting a play mode

STEP 1 Press that corresponds to “BROWSE” to select iPod® menu mode.

STEP 2 Press that corresponds to the desired play mode.

■ Play mode list

Play mode	First selection	Second selection	Third selection	Fourth selection
PLIST	Playlist select	Songs select	-	-
ARTIST	Artist select	Albums select	Songs select	-
ALBUM	Albums select	Songs select	-	-
GENRE	Genre select	Artists select	Albums select	Songs select
SONGS	Songs select	-	-	-
PODCST	Albums select	Songs select	-	-
COMPSR	Composers select	Albums select	Songs select	-
BOOK	Songs select	-	-	-

Depending on the model, the name of your iPod® may be displayed at the top of the list.

■ Selecting a list

STEP 1 Turn  to display the first selection list.

STEP 2 Press  to select the desired item.

Pressing  that corresponds to “MORE” changes to the second selection list.

STEP 3 Repeat the same procedure to select the desired song name.

To return to the previous selection list, press  that corresponds

to “”.

Selecting songs from a song list



STEP 1 Press  that corresponds to “LIST”.

The current playlist is displayed.

STEP 2 Turning  to select the desired song.

Press  returns the screen from list display to the previous screen.

Selecting songs

Turn  or press “^” or “v” on  to select the desired song.

Playing and pausing songs

Press .

Fast-forwarding and reversing songs

Press and hold “^” or “v” on .

Shuffle playback

■ Playing songs from one playlist or album in random order

Press  that corresponds to “RDM”.

To cancel, press the button twice.

■ Playing songs from all the playlists or albums in random order

Press  that corresponds to “RDM” twice.

To cancel, press the button again.

Repeat play

Press  that corresponds to “RPT”.

To cancel, press the button again.

Even when the repeat play option has not been selected, playback will automatically continue from the first song in the current play list once the last song has ended.

Switching the display

Press .

Each time is pressed, the display changes in the following order:

Track title → Track title/Artist name → Track title/Album name → Track title/Elapsed time

■ About iPod®

iPod® is registered trademarks of Apple, Inc.

■ iPod® functions

- When an iPod® is connected and the audio source is changed to iPod® mode, the iPod® will resume play from the same point at which it was last used.
- Depending on the iPod® that is connected to the system, certain functions may not be available. Disconnecting the device and reconnecting it once again may resolve some malfunctions.

■ iPod® problems

To resolve most problems encountered when using your iPod®, disconnect your iPod® from the vehicle iPod® connection and reset it.

For instructions on how to reset your iPod®, refer to your iPod® Owner's Manual.

■ Error messages

“IPOD ERROR”: This indicates a problem in the iPod®, inside the USB box or the connection between them.

“NO SONGS”: This indicates that there is no music data in the iPod®.

“UPDATE YOUR IPOD”: This indicates that the version of the iPod® is not compatible.

■ Compatible models

- iPod® 5th generation Version 1.2 or later
- iPod® nano 3rd generation Version 1.0 or later
- iPod® nano 2nd generation Version 1.1.2 or later
- iPod® nano Version 1.2 or later
- iPod® touch Version 1.1 or later
- iPod® classic Version 1.0 or later

iPhone®, iPod® mini, iPod® shuffle, iPod® photo and 4th generation and earlier models of iPod® are not compatible with this system.

Items related to standards and limitations are as follows:

- Maximum number of lists in device: 9999
- Maximum number of songs in device: 65,025
- Maximum number of songs per list: 65,025

CAUTION

■ Caution while driving

Do not connect iPod® or operate the controls.

NOTICE

■ To prevent damage to iPod®

- Do not leave iPod® in the vehicle. The temperature inside the vehicle may become high, resulting in damage to the player.
- Do not push down on or apply unnecessary pressure to the iPod® while it is connected as this may damage the iPod® or its terminal.
- Do not insert foreign objects into the port as this may damage the iPod® or its terminal.

3-2. Using the audio system Operating a USB memory*

Connecting a USB memory enables you to enjoy music from the vehicle speakers.

■ Connecting a USB memory

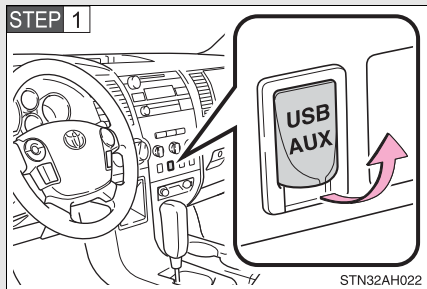

Open the cover and connect a USB memory.

STEP 2 Press **AUX**.

■ Control panel

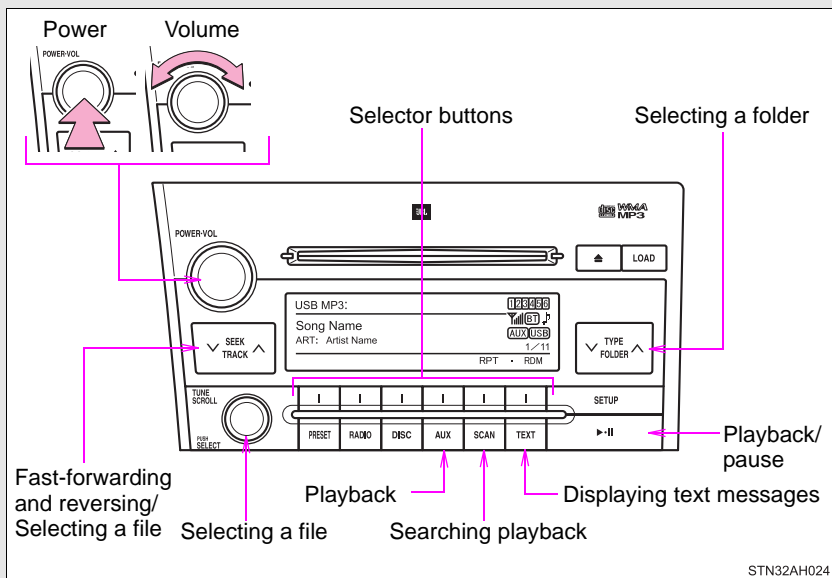

*: If equipped

Selecting and scanning a folder

■ Selecting a folder

Press “^” or “v” on  to select the desired folder.

■ Returning to the first file of the first folder

Press and hold “v” on  until you hear a beep.

■ Scanning the first file of all the folders



STEP 1 Press and hold  until you hear a beep.

The first ten seconds of the first file in each folder will be played.

STEP 2 When the desired folder is reached, press  again.

Selecting and scanning files

■ Selecting a file

Turn  or press “^” or “v” on  to select the desired file.

■ Scanning the files in a folder

Press .

The first ten seconds of each file will be played.

To cancel, press  again.

When the desired file is reached, press  again.

Playing and pausing files

Press  .

Fast-forwarding and reversing files

Press and hold “^” or “v” on  .

Random playback

■ Playing files from a folder in random order

Press  that corresponds to “RDM”.

To cancel, press the button twice.

■ Playing all the files from a USB memory in random order

Press  that corresponds to “RDM” twice.

To cancel, press the button again.

Repeat play

■ Repeating a file

Press  that corresponds to “RPT”.

To cancel, press the button twice.

■ Repeating all the files in a folder

Press  that corresponds to “RPT” twice.

To cancel, press the button again.

Switching the display

Press .

Each time is pressed, the display changes in the following order:
Track title → Track title/Artist name → Track title/Album name → Track title/Elapsed time

■ USB memory functions

Depending on the USB memory that is connected to the system, certain functions may not be available. Disconnecting the device and reconnecting it once again may resolve some malfunctions.

■ Error messages

“USB ERROR”: This indicates a problem in the USB memory, in the USB box or connection between them.

“NO MUSIC”: This indicates that no MP3/WMA files are included in the USB memory.

■ USB memory

● Compatible device

USB memory that can be used for MP3 and WMA playback.

Depending on the type of USB device, playback may not be possible.

● Compatible device formats

The following device formats can be used:

- USB communication formats: USB2.0 FS (12 mbps)
- File formats: FAT16/32 (Windows®)
- Correspondence class: Mass storage class
MP3 and WMA files written in any format other than those listed above may not play correctly, and their file names and folder names may not be displayed correctly.

Items related to standards and limitations are as follows:

- Maximum directory hierarchy: 8 levels
- Maximum number of folder in device: 999 (including the root)
- Maximum number of files in device: 65,025
- Maximum number of files per folder: 255

● MP3 and WMA files

MP3 (MPEG Audio LAYER 3) is a standard audio compression format.

Files can be compressed to approximately 1/10 of their original size using MP3 compression.

WMA (Windows Media® Audio) is a Microsoft® audio compression format.

This format compresses audio data to a size smaller than that of the MP3 format.

There is a limit to the MP3 and WMA file standards that can be used and to the media/formats on which the files are recorded.

● MP3 file compatibility

- Compatible standards
MP3 (MPEG1 AUDIO LAYERII, III, MPEG2 AUDIO LAYERII, III, MPEG2.5)
- Compatible sampling frequencies
MPEG1 AUDIO LAYERII, III: 32, 44.1, 48 (kHz)
MPEG2 AUDIO LAYERII, III: 16, 22.05, 24 (kHz)
MPEG2.5: 8, 11.025, 12 (kHz)
- Compatible bit rates (compatible with VBR)
MPEG1 AUDIO LAYERII, III: 32-320 (kbps)
MPEG2 AUDIO LAYERII, III: 32-160 (kbps)
MPEG2.5: 32-160 (kbps)
- Compatible channel modes: stereo, joint stereo, dual channel and monaural

● WMA file compatibility

- Compatible standards
WMA Ver. 9
- Compatible sampling frequencies
HIGH PROFILE 32, 44.1, 48 (kHz)
- Compatible bit rates
HIGH PROFILE 32-320 (kbps, VBR)

● File names

The only files that can be recognized as MP3/WMA and played are those with the extension .mp3 or .wma.

● ID3 and WMA tags

ID3 tags can be added to MP3 files, making it possible to record the track title, artist name, etc.

The system is compatible with ID3 Ver. 1.0, 1.1, and Ver. 2.2, 2.3, 2.4 ID3 tags. (The number of characters is based on ID3 Ver. 1.0 and 1.1.)

WMA tags can be added to WMA files, making it possible to record the track title and artist name in the same way as with ID3 tags.

● MP3 and WMA playback

When a device containing MP3 or WMA files is plugged, all files in the USB memory device are first checked. Once the file check is finished, the first MP3 or WMA file is played. To make the file check finish more quickly, we recommend you do not write in any files other than MP3 or WMA files or create any unnecessary folders.

- Extensions

If the file extensions .mp3 and .wma are used for files other than MP3 and WMA files, they will be mistakenly recognized and played as MP3 and WMA files. This may result in large amounts of interference and damage to the speakers.

- Playback

- To play MP3 files with steady sound quality, we recommend a fixed bit rate of at least 128 kbps and a sampling frequency of 44.1 kHz.
- There is a wide variety of freeware and other encoding software for MP3 and WMA files on the market, and depending on the status of the encoding and the file format, poor sound quality or noise at the start of playback may result. In some cases, playback may not be possible at all.
- Microsoft®, Windows®, and Windows Media® are the registered trademarks of Microsoft Corporation in the U.S.A. and other countries.

CAUTION

■ Caution while driving

Do not connect a USB memory or operate the controls.

NOTICE

■ To prevent damage to a USB memory

- Do not leave a USB memory in the vehicle. The temperature inside the vehicle may become high, resulting in damage to the player.
- Do not push down on or apply unnecessary pressure to the USB memory while it is connected as this may damage the USB memory or its terminal.
- Do not insert foreign objects into the port as this may damage the USB memory or its terminal.

3-2. Using the audio system

Optimal use of the audio system

► Type A

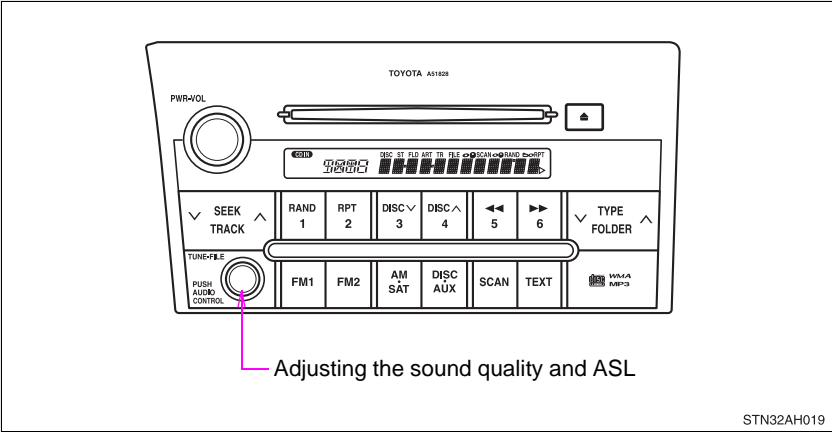

► Type B and C

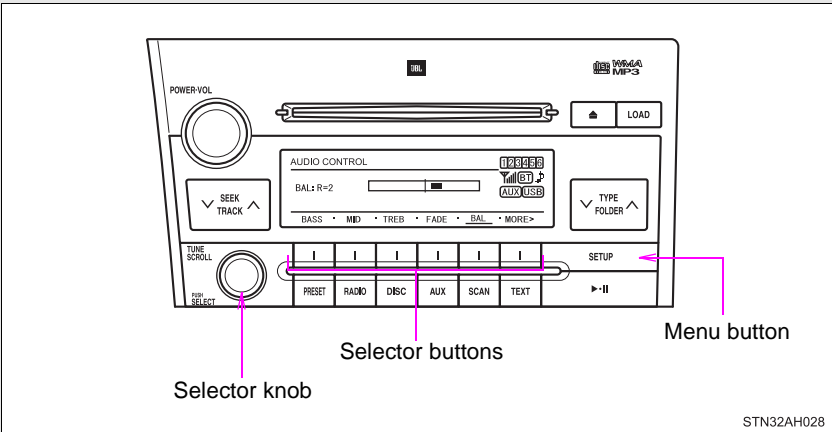

Using the audio control function

■ Changing sound quality modes

▶ Type A

Pressing  selects the mode to be changed in the following order:

“BAS”→“TRE”→“FAD”→“BAL”→“ASL”

▶ Type B and C

STEP 1 Press .

STEP 2 Press  that corresponds to the desired mode.

“BASS”, “MID” (type B only), “TREB”, “FADE”, or “BAL”

■ Adjusting sound quality

▶ Type A

Turning  adjusts the level.

Mode displayed	Sound quality mode	Level	Turn to the left	Turn to the right
BAS	Bass*	-5 to 5	Low	High
TRE	Treble*	-5 to 5		
FAD	Front/rear volume balance	F7 to R7	Shifts to rear	Shifts to front
BAL	Left/right volume balance	L7 to R7	Shifts to left	Shifts to right

*:The sound quality level is adjusted individually in each radio mode or CD mode.

► Type B and C

Turning  adjusts the level.

Mode displayed	Sound quality mode	Level	Turn to the left	Turn to the right
BASS	Bass*	-5 to 5	Low	High
MID	Mid-range* (type B only)	-5 to 5		
TREB	Treble*	-5 to 5		
FADE	Front/rear volume balance	F7 to R7	Shifts to rear	Shifts to front
BAL	Left/right volume balance	L7 to R7	Shifts to left	Shifts to right

*:The sound quality level is adjusted individually in each audio mode.

■ **Adjusting the Automatic Sound Levelizer (ASL)**

► Type A

When “ASL” is selected, turning  to the right changes the “ASL” level in the order of “LOW”, “MID” and “HIGH”.

Turning  to the left turns “ASL” off.

ASL automatically adjusts the volume and tone quality according to vehicle speed.

► Type B and C

STEP 1 Press .

STEP 2 Press  that corresponds to “MORE”.

STEP 3 Press  that corresponds to “ASL”.

STEP 4 Press  that corresponds to the desired mode.

Type B: “ON” or “OFF”

Type C: “LOW”, “MID”, “HIGH”, or “OFF”

ASL automatically adjusts the volume and tone quality according to vehicle speed.

■ Setting the number of preset pages (type B and C)

The number of preset pages desired can be set from 1 to 6. The initial setting is 6 pages.

STEP 1 Press .

STEP 2 Press  that corresponds to “MORE”.

STEP 3 Press  that corresponds to “PRESET”.

STEP 4 Press  that corresponds to the desired number of preset pages.

■ Language settings (type B and C)

→P. 312

3-2. Using the audio system Using the AUX adapter*

This adapter can be used to connect a portable audio device and listen to it through the vehicle's speakers.

STEP 1 Open the cover and connect the portable audio device.

► Type A

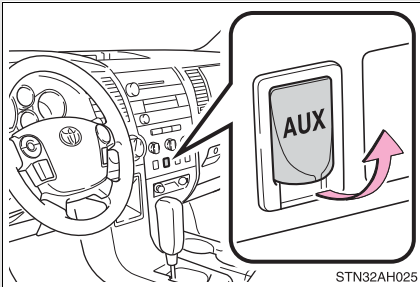

► Type B and C

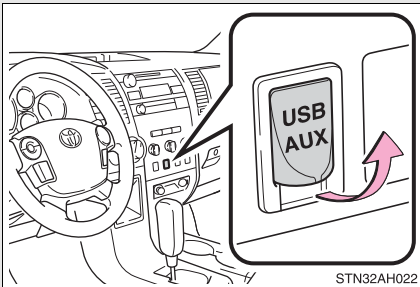

STEP 2 Press **DISC
AUX** or **AUX** .

*: If equipped

■ **Operating portable audio devices connected to the audio system**

The volume can be adjusted using the vehicle's audio controls. All other adjustments must be made on the portable audio device itself.

■ **When using a portable audio device connected to the power outlet**

Noise may occur during playback. Use the power source of the portable audio device.

Using the steering wheel audio switches*

Some audio features can be controlled using the switches on the steering wheel.

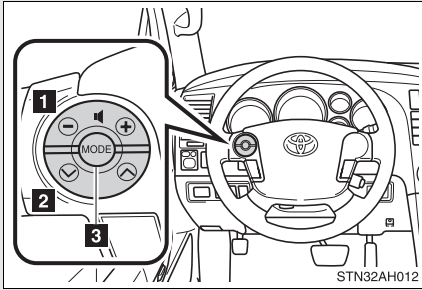

1 Increases/decreases volume

2 Radio mode: Selects radio station

CD mode: Selects track/file, folder and disc

iPod® mode: Selects a song

USB memory mode: Selects a file and folder

Bluetooth® audio mode: Selects a track and album

RSE mode: Selects track/file and chapter

3 Turns the power on, selects an audio source

*: If equipped

Turning the power on

Press  when the audio system is turned off.

The audio system can be turned off by holding the switch down until you hear a beep.

Changing the audio source

Press  when the audio system is turned on. The audio source changes as follows each time the switch is pressed.

If no discs are inserted in the player, that mode will be skipped.

Type A:

FM1→FM2→CD→AUX→AM→SAT1→SAT2→SAT3

Type B:

FM→SAT→CD changer→RSE*→Bluetooth® audio→AUX→
USB/iPod®→AM

Type C:

FM→SAT→CD→Bluetooth® audio→AUX→USB/iPod®→AM

*: Vehicles with rear seat entertainment system

Adjusting the volume

Press “+” on  to increase the volume and “-” to decrease the volume.

Press and hold the switch to continue increasing or decreasing the volume.

Selecting a radio station

STEP 1 Press  to select the radio mode.

STEP 2 Press “√” or “^” on  to select a radio station.

To scan for receivable stations, press and hold “√” or “^” on  until you hear a beep.

Selecting a track/file or song

STEP 1 Press  to select the CD, iPod®, USB memory, Bluetooth® audio or RSE mode.

STEP 2 Press “√” or “∧” on  to select the desired track/file or song.

Selecting a folder or album

STEP 1 Press  to select the CD, USB memory or Bluetooth® audio mode.

STEP 2 Press and hold “√” or “∧” on  until you hear a beep.

Selecting a disc in the CD player (type B only)

STEP 1 Press  to select the CD mode.

STEP 2 Press and hold “√” or “∧” on  until you hear a beep.

Selecting a track/file or chapter (vehicles with rear seat entertainment system)

STEP 1 Press  to select the RSE mode.

STEP 2 Press “√” or “∧” on  to select the desired track/file or chapter.

CAUTION

To reduce the risk of an accident

Exercise care when operating the audio switches on the steering wheel.

3-3. Using the Bluetooth® audio system

Bluetooth® audio system*

The Bluetooth® audio system enables you to enjoy music played on a portable digital audio player (portable player) from the vehicle speakers via wireless communication.

This audio system supports Bluetooth®, a wireless data system capable of playing portable audio music without cables. If your portable player does not support Bluetooth®, the Bluetooth® audio system will not function.

Owners of models equipped with a navigation system should refer to the “Navigation System Owner’s Manual”.

Title	Page
Using the Bluetooth® audio system	P. 364
Operating a Bluetooth® enabled portable player	P. 369
Setting up a Bluetooth® enabled portable player	P. 371
Bluetooth® audio system setup	P. 376

■ Conditions under which the system will not operate

- If using a portable player that does not support Bluetooth®
- If the portable player is switched off
- If the portable player is not connected
- If the portable player’s battery is low
- If the portable player is behind the seat or in the glove box or console box
- If metal is covering or touching the portable player

*: If equipped

■ **When transferring ownership of the vehicle**

Be sure to initialize the system to prevent personal data from being improperly accessed. (→P. 434)

■ **About Bluetooth®**



Bluetooth is a registered trademark of Bluetooth SIG, Inc.

■ **Compatible models**

● Bluetooth® specifications:
Ver. 1.2

● Following Profiles:

- A2DP (Advanced Audio Distribution Profile) Ver. 1.0
- AVRCP (Audio/Video Remote Control Profile) Ver. 1.0 or higher (Ver. 1.3 or higher recommended)

Portable players must correspond to the above specifications in order to be connected to the Bluetooth® audio system. However, please note that some functions may be limited depending on the type of portable player.

■ **Certification for the Bluetooth® audio system**

FCC ID: ACJ932C5ZZZ035

IC ID: 216J-C5ZZZ035

MADE IN MEXICO

This device complies with Part 15 of the FCC Rules and RSS-210 Rules. Operation is subject to the following two conditions; (1) This device may not cause harmful interference, and (2) This device must accept any interference received, including interference that may cause undesired operation.

 **CAUTION****■ FCC WARNING**

Changes or modifications in construction not expressly approved by the party responsible for compliance could void the user's authority to operate the equipment.

Radio frequency exposure. This device is approved for Mobile Application only and, to comply with applicable FCC radio frequency exposure regulations, must be used with a distance of at least 7.9 in. (20 cm) between the antenna and the body of any person at all time during use.

■ Caution while driving

Do not connect portable players or operate the controls.

 **NOTICE****■ To prevent damage to portable players**

Do not leave portable players in the vehicle. The temperature inside the vehicle may become high, resulting in damage to the player.

3-3. Using the Bluetooth® audio system

Using the Bluetooth® audio system

■ Audio unit

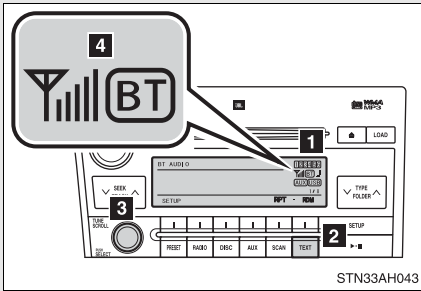

1 Display

A message, name, number, etc. is displayed.

Lower-case characters and special characters cannot be displayed.

2 Displays information that is too long to be displayed at one time on the display (press and hold)

3 Selects items such as menu and number

Turn: Selects an item

Press: Inputs the selected item

4 Bluetooth® connection condition

If “BT” is not displayed, the Bluetooth® audio system cannot be used.

■ Microphone

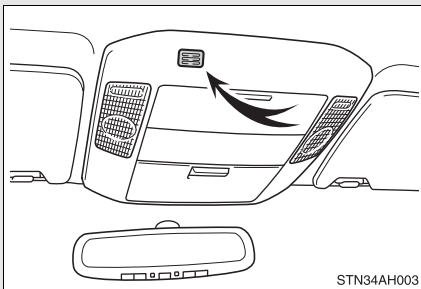

Operating the system using voice commands

By following the voice guidance instructions output from the speaker, voice commands enable the operation of the Bluetooth® audio system without the need to check the display or operate .

■ Operation procedure when using voice commands

Press the talk switch and follow the voice guidance instructions.

■ Auxiliary commands when using voice commands

The following auxiliary commands can be used when operating the system using a voice command:

“Cancel”: Exits the Bluetooth® audio system

“Repeat”: Repeats the previous voice guidance instruction

“Go back”: Returns to the previous procedure

“Help”: Reads aloud the function summary if a help comment is registered for the selected function

Using the Bluetooth® audio system for the first time

Before using the Bluetooth® audio system, it is necessary to register a Bluetooth® enabled portable player in the system. Follow the procedure below to register (pair) a portable player:

STEP 1 Press  until “BT AUDIO” is displayed.

STEP 2 Press  that corresponds to “SETUP”.

The introductory guidance and portable player name registration instructions are heard.

STEP 3 Select “Pair Audio Player” using a voice command or  .

STEP 4 Register a portable player name by either of the following methods:

a. Select “Record Name” using  , and say the name to be registered.

b. Press the talk switch and say the name to be registered.

A voice guidance instruction to confirm the input is heard.

STEP 5 Select “Confirm” using a voice command or  .

A passkey is displayed and heard, and a voice guidance instruction for inputting the passkey into the portable player is heard.

STEP 6 Input the passkey into the portable player.

Refer to the manual that comes with the portable player for the operation of the portable player.

Guidance for registration completion is heard.

If the portable player has a Bluetooth® phone, the phone can be registered at the same time. (→P. 419)

Menu list of the Bluetooth® audio system

■ Normal operation

First menu	Second menu	Third menu	Operation detail
"Setup"	"BT•A Setup"	"Pair Audio Player"	Registering a portable player
		"Select Audio Player"	Selecting a portable player to be used
		"Change Name"	Changing the registered name of a portable player
		"List Audio Players"	Listing the registered portable players
		"Set Passkey"	Changing the passkey
		"Delete Audio"	Deleting a registered portable player
	"System Setup"	"Guidance Volume"	Setting voice guidance volume
		"Device Name"	Displaying the Bluetooth® device address and name
		"Initialize"	Initializing the system

"BT•A Setup" can be canceled by pressing the on-hook switch or saying the voice command, "Cancel".

■ **When using a voice command**

For numbers, say a combination of single digits from zero to nine.

Say the command correctly and clearly.

■ **The system may not recognize your voice in the following situations:**

- When driving on rough roads
- When driving at high speeds
- When air is blowing out of the vents onto the microphone
- When the air conditioning fan emits a loud noise

■ **Operations that cannot be performed while driving**

- Operating the system with The image shows two circular buttons. The top button is labeled 'TUNE SCROLL' and the bottom button is labeled 'SOURCE SELECT'. Both buttons have a central circular icon with a vertical line through it.
- Registering a portable player to the system

■ **Changing the passkey**

→P. 374

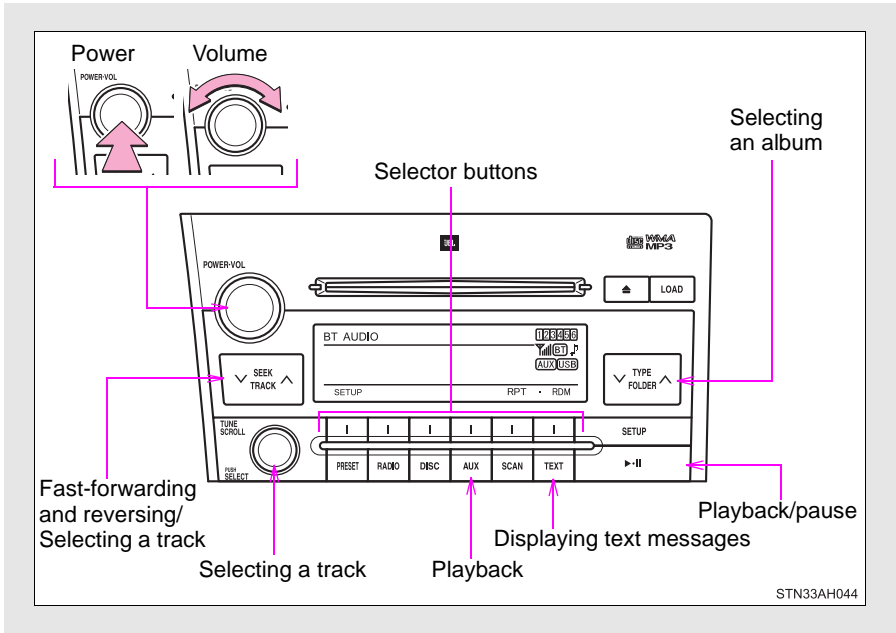

3-3. Using the Bluetooth® audio system Operating a Bluetooth® enabled portable player



Selecting an album

Press “∨” or “∧” on  .

Selecting tracks

Turn  or press “∧” or “∨” on  to select the desired track.

Playing and pausing tracks

Press  .

Fast-forwarding and reversing tracks

Press and hold “^” or “v” on  .

Switching the display

Press  .

Each time  is pressed, the display changes in the following order:

Track title → Track title/Artist name → Track title/Album name → Track title/Elapsed time

Using the steering wheel audio switches

→P. 358

■ Bluetooth® audio system functions

Depending on the portable player that is connected to the system, certain functions may not be available.

■ Error messages

“BT AUDIO ERROR”: This indicates a problem in the system.

3-3. Using the Bluetooth® audio system Setting up a Bluetooth® enabled portable player

Registering a portable player in the Bluetooth® audio system allows the system to function. The following functions can be used for registered portable players:

■ Functions and operation procedures

STEP 1 Press  until “BT AUDIO” is displayed.

STEP 2 Press  that corresponds to “SETUP”.

STEP 3 Select one of the following functions using a voice command or .

- Registering a portable player
“Pair Audio Player”
- Selecting a portable player to be used
“Select Audio Player”
- Changing the registered name
“Change Name”
- Listing the registered portable players
“List Audio Players”
- Changing the passkey
“Set Passkey”
- Deleting a registered portable player
“Delete Audio Player (Delete Audio)”

Registering a portable player

Select “Pair Audio Player” using a voice command or , and perform the procedure for registering a portable player. (→P. 366)

Selecting a portable player to be used

STEP 1 Select “Select Audio Player” using a voice command or



STEP 2 Select the portable player to be used by either of the following methods, and select “Confirm” by using a voice command or



- a. Press the talk switch and say the name of the desired portable player.
- b. Press the talk switch and say “List Audio Players”. When the name of the desired portable player is read aloud, press the talk switch.

STEP 3 Press the talk switch and say “From Car” or “From Audio”, and select “Confirm” by using a voice command or



If “From Car” is selected, the portable player will be automatically connected whenever the engine switch is in either the “ACC” or “ON” position.

Changing the registered name of a portable player

STEP 1 Select “Change Name” using a voice command or  .

STEP 2 Select the name of the portable player to be changed by either of the following methods, and select “Confirm” using a voice command or  :

- Press the talk switch and say the name of desired portable player.
- Press the talk switch and say “List Audio Players”. When the name of the desired portable player is read aloud, press the talk switch.

STEP 3 Press the talk switch or select “Record Name” using  , and say the new name.

STEP 4 Select “Confirm” using a voice command or  .

Listing the registered portable players

Select “List Audio Players” using a voice command or  . The list of registered portable players will be read aloud. When listing is complete, the system returns to “BT•A Setup”.

Pressing the talk switch while the name of a portable player is being read aloud selects the portable player, and the following functions will become available:

- Selecting a portable player: “Select Audio Player”
- Changing a registered name: “Change Name”
- Deleting a portable player: “Delete Audio Player (Delete Audio)”

Changing the passkey

STEP 1 Select “Set Passkey” using a voice command or  .

STEP 2 Press the talk switch, say a 4 to 8-digit number, and select “Confirm” using a voice command or  .

STEP 3 When the entire number to be registered as a passkey has been input, press  again.

If the number to be registered has 8 digits, pressing of the knob is not necessary.

Deleting a registered portable player

STEP 1 Select “Delete Audio Player (Delete Audio)” using a voice command or  .

STEP 2 Select the portable player to be deleted by either of the following methods and select “Confirm” using a voice command or  :

- Press the talk switch and say the name of the desired portable player.
- Press the talk switch and say “List Audio Players”. When the name of the desired portable player is read aloud, press the talk switch.

If the portable player to be deleted is paired as a Bluetooth® phone, the registration of the mobile phone can be deleted at the same time. A voice guidance instruction to delete a mobile phone is heard.

STEP 3 Select “Confirm” by using a voice command or  .

■ **The number of portable players that can be registered**

Up to 2 portable players can be registered in the system.

■ **System setup items and operation procedures**

● **Setting voice guidance volume**

1. "Setup" → 2. "System Setup" → 3. "Guidance Volume"
(→P. 434)

● **Displaying the Bluetooth® device address and name**

1. "Setup" → 2. "System Setup" → 3. "Device Name"
(→P. 435)

● **Initialization**

1. "Setup" → 2. "System Setup" → 3. "Initialize"
(→P. 435)

Rear seat entertainment system*

The rear seat entertainment system is designed for the rear passengers to enjoy audio and DVD video separately from the front audio system.

► Front separated type seats

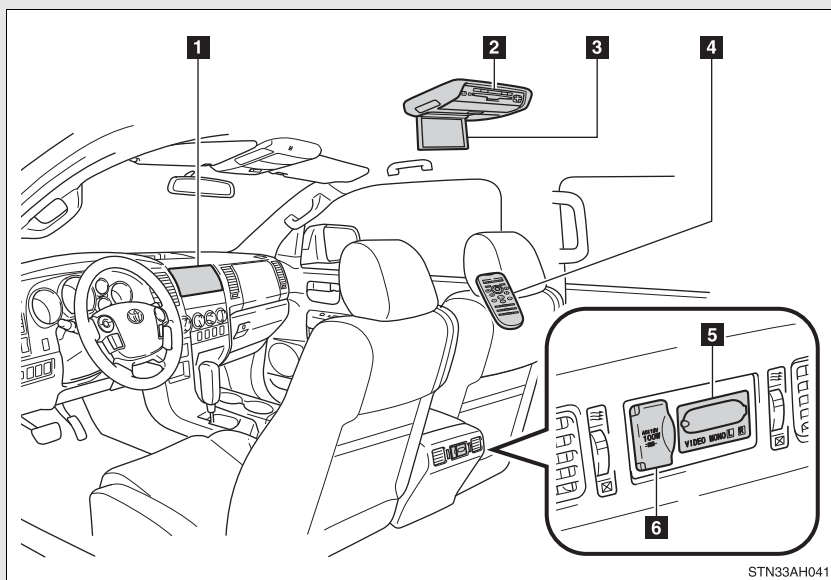

- 1** Front audio system
- 2** DVD player
- 3** Display
- 4** Rear seat entertainment system remote controller
- 5** A/V input adapter
- 6** Power outlet

STN33AH041

*: If equipped

► Front bench type seat

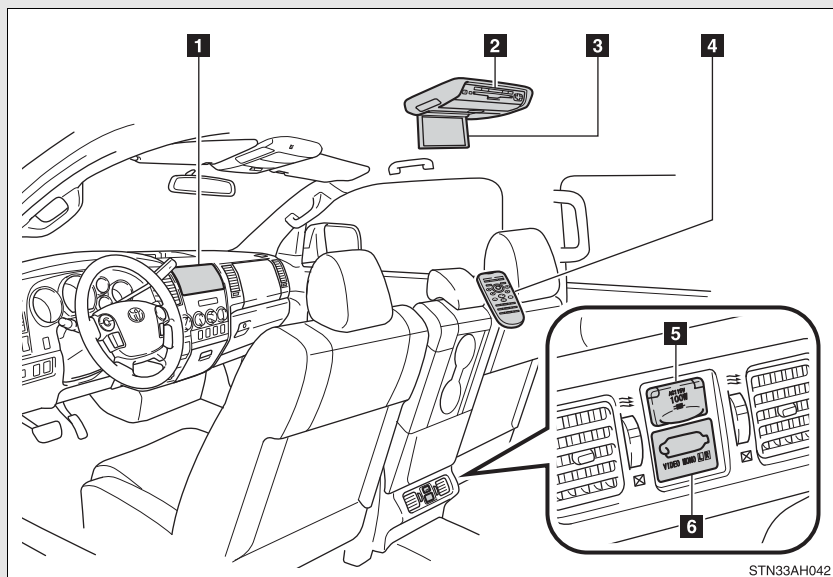

- 1** Front audio system
- 2** DVD player
- 3** Display
- 4** Rear seat entertainment system remote controller
- 5** Power outlet
- 6** A/V input adapter

Opening and closing the display

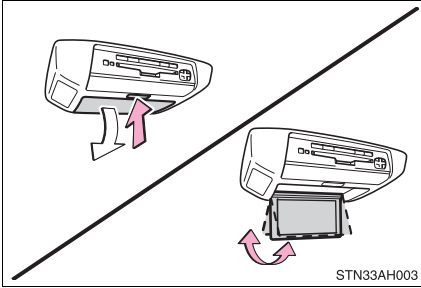

Press the lock release button to open the display.

Pull the display down to an easily viewable angle (between 90° and 125°).

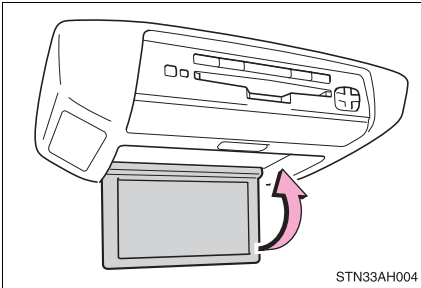

To close the display, push the display up until a click is heard.

The illumination of the screen is automatically turned off when the display is closed. However, the rear seat entertainment system is not turned off.

Loading a disc

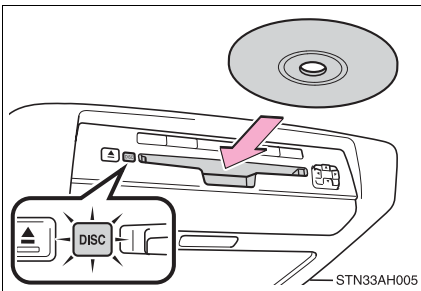



Insert the disc into the slot with the label side up.

The DISC indicator light turns on while the disc is loaded.

The player will play the track or chapter, and will repeat it after it reaches the end.

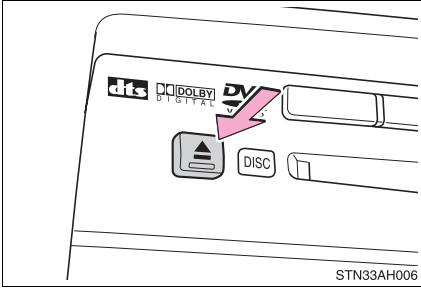
Ejecting a disc



Press  and remove the disc.

Turning the rear seat entertainment system power on/off

■ Operating from the front audio system

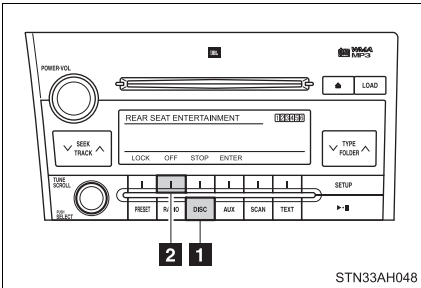

1 Selecting either the front audio system or DVD player audio for the speakers

2 Press  that corresponds to “OFF”, to turn off the rear seat entertainment system.

Press  that corresponds to “ON”, to turn on the rear seat entertainment system.

Setting the rear seat entertainment system lock

► Front audio system

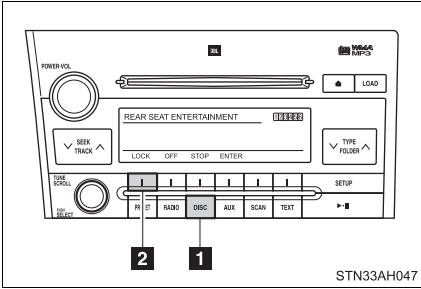

1 Selecting either the front audio system or DVD player audio for the speakers

2 Selecting “LOCK” or “UNLOCK” for the rear seat entertainment system

The rear seat entertainment system lock remains on, even when the engine switch is turned off.

► DVD player display

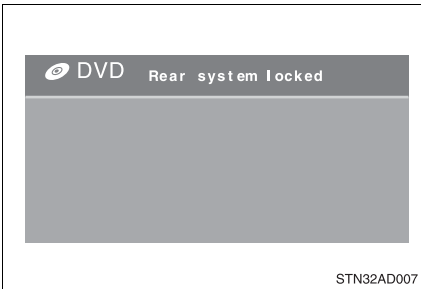

■ **The rear seat entertainment system can be used when**

The engine switch is in the ACC or ON position.

■ **Discs that can be used**

Discs with the marks shown below can be used.

Playback may not be possible depending on recording format or disc features, or due to scratches, dirt or deterioration.



■ **When  appears on the screen**

It indicates that the selected switch cannot work.

■ **Error messages**

- “DISC CHECK”:
Indicates that the disc is dirty, damaged or was inserted upside down. Clean the disc or insert it correctly.
- “REGION CODE ERROR”:
Indicates that the DVD region code is not set properly.
- “DVD ERROR”:
Indicates that there is a problem inside the player. Eject the disc. Set the disc again.
If the malfunction still exists, take the vehicle to your Toyota dealer.

■ Before using the remote controller (for new vehicle owners)

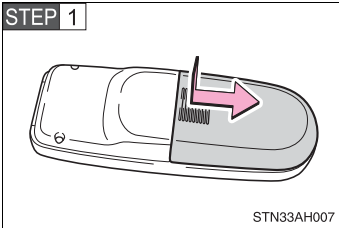

Remove the cover.

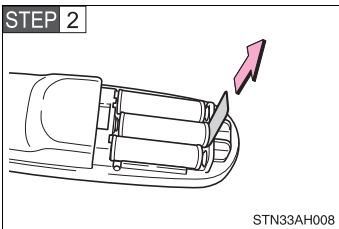

Remove the insulating sheet.

■ When the remote controller batteries are fully depleted

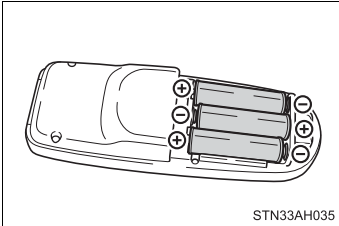

Remove the depleted batteries and install 3 new AA batteries.

■ If the remote controller batteries are discharged

The following symptoms may occur.

- The rear seat entertainment system control will not function properly.
- The operational range is reduced.

■ When replacing the AA batteries

Batteries can be purchased at your Toyota dealer, electric appliance shop, or camera stores.

Replace only with the same or equivalent type recommended by a Toyota dealer.

Dispose of used batteries according to local laws.

■ Headphones

With some headphones generally available in the market, sound quality may be poor. Toyota recommends the use of Toyota genuine wireless headphones.

Please contact your Toyota dealer for further details.

■ Volume

Conversational speech on some DVDs is recorded at a low volume to emphasize the impact of sound effects. If you adjust the volume assuming that the conversations represent the maximum volume level that the DVD will play, you may be startled by louder sound effects or when you change to a different audio source. Be sure to adjust the volume with this in mind.

CAUTION

■ While driving

Do not use headphones.

Doing so may cause an accident, resulting in death or serious injury.

■ When the rear seat entertainment system is not used

Keep the display closed.

In the event of an accident or sudden braking, the opened display may hit an occupant's body, resulting in injury.

■ To prevent accidents and electric shock

Do not disassemble or modify the remote controller.

■ When the remote controller is not used

Stow the remote controller.

Injuries may result in the event of an accident or sudden braking.

■ Removed batteries and other parts

Keep away from children.

These parts are small and if swallowed by a child they can cause choking.

**NOTICE****■ For normal operation after replacing the batteries**

Observe the following precautions to prevent accidents.

- Always work with dry hands.
Moisture may cause the battery to rust.
- Do not touch or move any other components inside the remote controller.
- Do not bend any of the battery terminals.

Using the DVD player (DVD video)

■ Remote controller

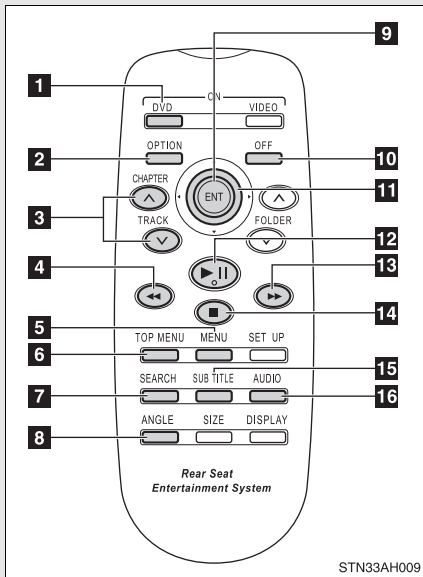

- 1** Turning on the DVD mode
- 2** Turning on/off the control icon screen
- 3** Selecting a chapter
- 4** Reversing a disc
- 5** Turning on the menu screen
- 6** Turning on the title selection screen
- 7** Searching the title
- 8** Changing the screen angle
- 9** Inputting the selected control icon
- 10** Turning off the screen
- 11** Selecting a control icon
- 12** Playing/pausing a disc
- 13** Fast-forwarding a disc
- 14** Stopping a disc
- 15** Changing the subtitle language
- 16** Changing the audio language

■ Unit

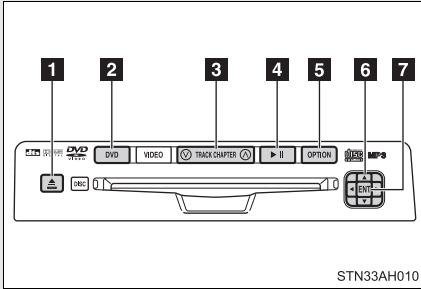

- 1** Ejecting a disc
- 2** Turning on the DVD mode
- 3** Skipping to the desired chapter
- 4** Playing/pausing a disc
- 5** Turning on/off the control icon screen
- 6** Selecting a control icon
- 7** Inputting the selected control icon

■ Control icon screen (Page1)

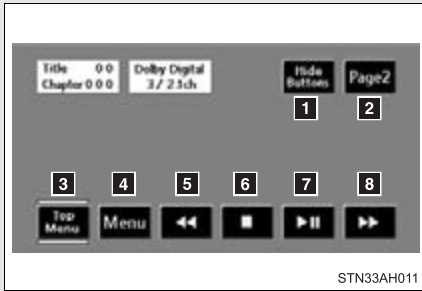

- 1 Turning off the control icon screen on the screen
- 2 Displaying control icon screen page 2
- 3 Turning on/off the title selection screen for the disc
- 4 Turning on/off the menu screen for the disc
- 5 Reversing a disc
- 6 Stopping a disc
- 7 Playing/pausing a disc
- 8 Fast-forwarding a disc

■ Control icon screen (Page2)

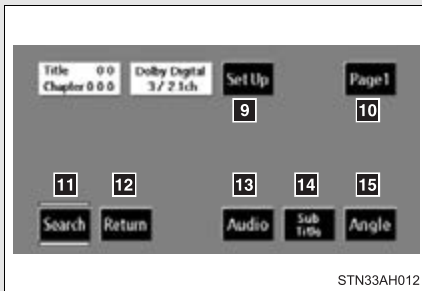

- 9 Displaying the initial setting screen
- 10 Displaying control icon screen page 1
- 11 Searching the title
- 12 Returning to the previous screen
- 13 Changing the audio language
- 14 Changing the subtitle language
- 15 Changing the angle

■ Operating from the front audio system

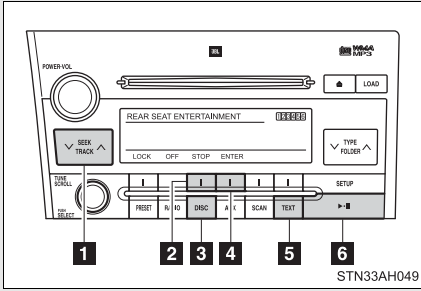

- 1** Press: Selecting a chapter
Press and hold: Fast-forwarding/reversing a disc
- 2** Stopping/playing a disc
- 3** Selecting the DVD mode
- 4** Starting a disc
- 5** Displaying a elapsed time
- 6** Playing/pausing a disc

⚠ NOTICE

■ Cleaning the screen

Wipe the screen with a dry soft cloth.

If the screen is wiped with a rough cloth, the surface of the screen may be scratched.

■ To prevent damage to the remote controller

- Keep the remote controller away from direct sunlight, heat and high humidity.
- Do not drop or knock the remote controller against hard objects.
- Do not sit on or place heavy objects on the remote controller.

■ DVD player



Never try to disassemble or oil any part of the DVD player. Do not insert anything other than a disc into the slot.

Turning on/off the control icon screen



Press or to turn on the control icon screen.

Press or once again or select to turn off the control icon screen.

Turning on the title selection screen

Press  or select  to turn on the title selection screen. For the operation of the title selection screen, see the separate manual for the DVD disc.

Turning on the menu screen



Press  or select  to turn on the menu screen. For the operation of the menu screen, see the separate manual for the DVD disc.

Returning to the previous screen

Select  to return to the previous screen. For the operation of the menu screen, see the separate manual for the DVD disc.

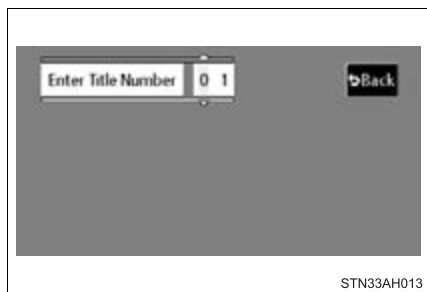
Searching for a title



Press  or select  to display the screen to search for a title.



Select the title number, and press



 or  to input it.

Select  to return to the previous screen.

Changing the subtitle language





Press  or select  to display the subtitle language screen.



Each time  is pressed or  is selected, another language stored on the disc is selected.

Select  to return to the previous screen.

Changing the audio language



Press  or select  to display the audio language screen.

Each time  is pressed or  is selected, another language stored on the disc is selected.

Select  to return to the previous screen.

Changing the angle



Press or select **Angle** to display the screen to change the angle.

Each time is pressed or **Angle** is selected, the angle changes.

Select **Back** to return to the previous screen.





■ DVD player and DVD video discs

This DVD player is compatible with NTSC color TV formats. DVD video discs conforming to other formats such as PAL or SECAM cannot be used.

■ Region codes

Some DVD video discs have a region code indicating where you can use them. If the DVD video disc is not labeled "ALL" or "1", you cannot use it in this DVD player. If you attempt to play an inappropriate DVD video disc in this player, "REGION CODE ERROR" appears on the screen. Even if the DVD video disc does not have a region code, in some cases you cannot use it.

■ Marks shown on DVD video discs

NTSC	Indicates NTSC format of color TV.
	Indicates the number of audio tracks.
	Indicates the number of language subtitles.
	Indicates the number of angles.
	Indicates the screen to be selected. Wide screen: 16:9 Standard: 4:3
	Indicates regions in which this video disc can be played. All: all countries Number: region code

■ DVD video disc glossary

- DVD video discs: Digital Versatile Discs that hold world's standard video. DVD video discs have adopted "MPEG2", one of the world standards of digital compression technologies. The picture data is compressed by 1/40 on average and stored. Variable rate encoded technology has been adopted in which the volume of data assigned to the picture is changed depending on the picture format. Audio data is stored using PCM and Dolby digital, which enables higher sound. Furthermore, multi-angle and multi-language features will also help you enjoy the more advanced technology of DVD video.
- Viewer restrictions: This feature limits what can be viewed in conformity with the level of restrictions of the country. The level of restrictions varies depending on the DVD video disc. Some DVD video discs cannot be played at all, or violent scenes are skipped or replaced with other scenes.
 - Level 1: DVD video discs for children can be played.
 - Level 2 - 7: DVD video discs for children and G-rated movies can be played.
 - Level 8: All types of DVD video discs can be played.

- Multi-angle feature: Allows you to enjoy the same scene at different angles.
- Multi-language feature: Allows you to select the language of the subtitles and audio.
- Region codes: Region codes are provided on DVD players and DVD discs. If the DVD video disc does not have the same region code as the DVD player, you cannot play the disc on the DVD player.
- Audio: This DVD player can play linear PCM, Dolby digital, dts and MPEG audio format DVD. Other decoded types cannot be played.
- Title and chapter: Video and audio programs stored on DVD video discs are divided into sections by title and chapter.
- Title: The largest unit of the video and audio programs stored on DVD video discs. Usually, one piece of a movie, one album, or one audio program is assigned as a title.
- Chapter: A unit smaller than a title. A title comprises multiple chapters.

■ Audio

Manufactured under license from Dolby Laboratories. “Dolby”, “Dolby Digital”, “Pro Logic”, and the double-D symbol are trademarks of Dolby Laboratories.

Confidential unpublished works.

©1992-1997 Dolby Laboratories. All rights reserved.

“dts” is a trademark of Digital Theater Systems, Inc.

3-4. Using the rear audio/video system Using the DVD player (video CD)

■ Remote controller

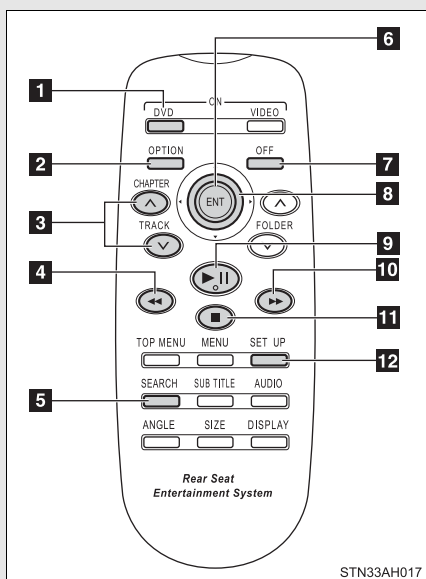

- 1** Turning on the DVD mode
- 2** Turning on/off the control icon screen
- 3** Selecting a chapter
- 4** Reversing a disc
- 5** Searching the disc menu number
- 6** Inputting the selected control icon
- 7** Turning off the screen
- 8** Selecting a control icon
- 9** Playing/pausing a disc
- 10** Fast-forwarding a disc
- 11** Stopping a disc
- 12** Changing the initial setting

■ Unit

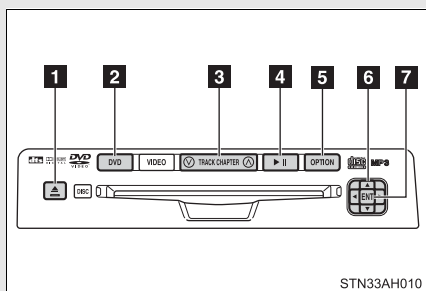

- 1** Ejecting a disc
- 2** Turning on the DVD mode
- 3** Skipping to the desired chapter
- 4** Playing/pausing a disc
- 5** Turning on/off the control icon screen
- 6** Selecting a control icon
- 7** Inputting the selected control icon

■ Control icon screen (Page1)

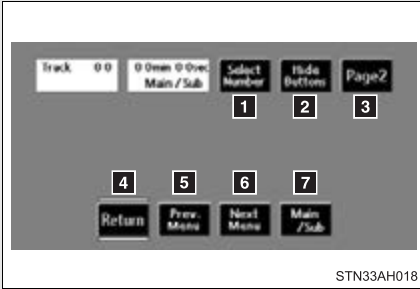

- 1 Selecting a disc menu number
- 2 Turning off the menu screen
- 3 Displaying control icon screen page 2
- 4 Turning on the disc menu
- 5 Returning to the previous page screen (with the disc menu displayed)
- 6 Proceeding to the next page screen (with the disc menu displayed)
- 7 Changing to a multiplex transmission

■ Control icon screen (Page2)

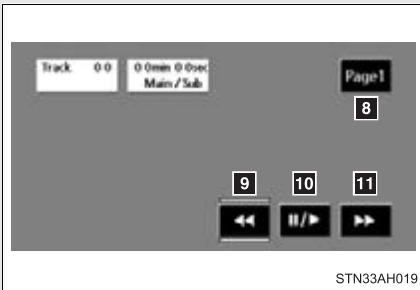

- 8 Displaying control icon screen page 1
- 9 Reversing a disc
- 10 Playing/pausing a disc
- 11 Fast-forwarding a disc

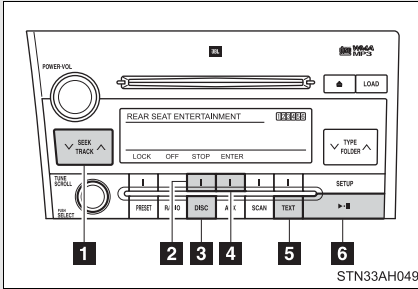

■ Operating from the front audio system



- 1** Press: Selecting a chapter
Press and hold: Fast-forwarding/reversing a disc
- 2** Stopping/playing a disc
- 3** Selecting the DVD mode
- 4** Starting a disc
- 5** Displaying a elapsed time
- 6** Playing/pausing a disc

Selecting a disc menu number

Select **Select Number** to display the disc menu number search screen.

Select the disc menu number, and press  or  to input it.

Select **Back** to return to the previous screen.

Using the DVD player (audio CD/CD text)

■ Control screen

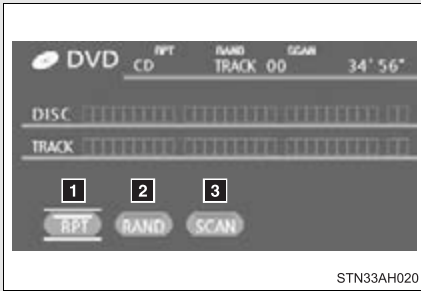

Press or to display the control screen.

- 1 Repeat play
- 2 Random playback
- 3 Search playback

■ Operating from the front audio system

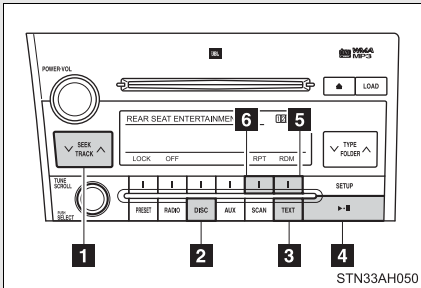

1 Press: Selecting a track
Press and hold: Fast-forwarding/reversing a disc

- 2 Selecting the DVD mode
- 3 Displaying a elapsed time
- 4 Playing/pausing a disc
- 5 Random playback

(→P. 326)

6 Repeat play (→P. 326)

Repeat play

■ Repeating a track

Select .

Random playback

■ Playing all of the tracks on a CD in random order

Select .

Search playback

■ Scanning tracks

STEP 1 Select **SCAN**.

The first 10 seconds of each track will be played.

STEP 2 Select **SCAN** again when the desired track is reached.

■ Canceling repeat play and random playback



Select **RPT** or **RAND** once again.

3-4. Using the rear audio/video system

Using the DVD player (MP3 discs)

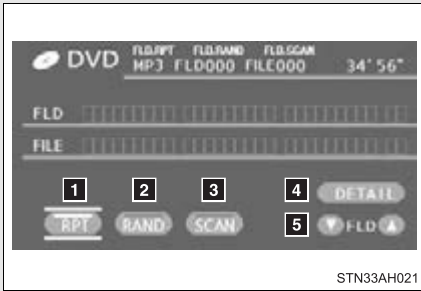
■ Control screen



Press  or  to display the control screen.

- 1 Repeat play
- 2 Random playback
- 3 Search playback
- 4 Displaying file information
- 5 Selecting a folder

■ Operating from the front audio system

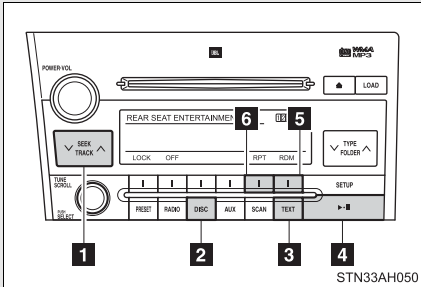



- 1 Press: Selecting a file
Press and hold: Fast-forwarding/reversing a file
- 2 Selecting the DVD mode
- 3 Displaying a elapsed time
- 4 Playing/pausing a disc
- 5 Random playback (→P. 333)
- 6 Repeat play (→P. 334)

Repeat play

■ Repeating a file

Select .

■ Repeating all of the files in the folder



Select , and press and hold  or .

Random playback

■ Playing files from a particular folder in random order

Select **RAND**.

■ Playing all of the files on a disc in random order



Select **RAND**, and press and hold  or .

Selecting and scanning folders

■ Selecting folders one at a time

To select the desired folder, select  or .

■ Scanning the desired folder by cueing the first file of each folder

STEP 1 Select **SCAN**, and press and hold  or .

The first 10 seconds of the first file in each folder will be played.

STEP 2 When the desired folder is reached, select **SCAN** once again.

Scanning files

■ Scanning the desired file by cueing the files in the folder

STEP 1 Select **SCAN**.

The first 10 seconds of all files in the folder will be played.

STEP 2 When the desired file is reached, select **SCAN** once again.

Displaying file information.



Select **DETAIL**.

■ **Canceling repeat play and random playback**

Select **RPT** or **RAND** once again.

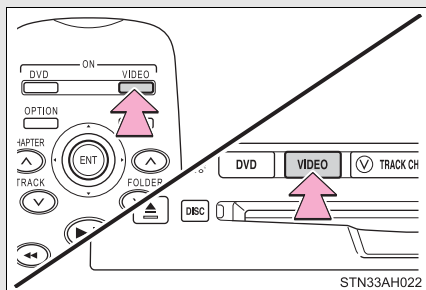
3-4. Using the rear audio/video system Using the video mode



Press  or  to select the video mode.

Before switching to the video mode, connect the audio source to the A/V input adapter.

Using the A/V input adapter

▶ Front separated type seats

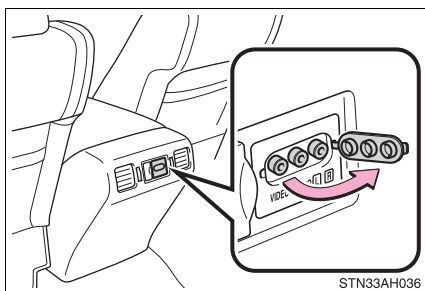

Open the cover.

The A/V input adapter is composed of 3 input adapters.

Yellow: Image input adapter

White: Left channel audio input adapter

Red: Right channel audio input adapter

▶ Front bench type seat

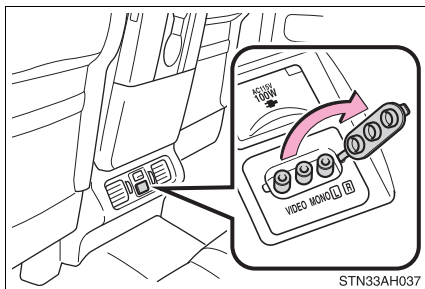

Open the cover.

The A/V input adapter is composed of 3 input adapters.

Yellow: Image input adapter

White: Left channel audio input adapter

Red: Right channel audio input adapter

■ **A/V input adapter**

The rear seat entertainment system plays videos and sound when audio-visual equipment is connected to the A/V input adapter. For details, refer to the manufacturer's instructions.

■ **Power outlet**

The power outlet can be used to connect the audio-visual device.
(→P. 482, 487)



NOTICE

■ **When the A/V input adapter is not in use**

Keep the A/V input adapter cover closed.

Inserting anything other than an appropriate plug may cause electrical failure or a short circuit.

Changing the Setup Menu settings



Press **SET UP** or select **Set Up** to display the initial setting screen.

The following settings can be customized here.

- Audio language
- Subtitle language
- DVD language
- Angle mark
- Parental lock

Changing the audio language

STEP 1 Select **Audio Language**.



Select the language you want to hear, and press **ENT** or **ENT** to input it.

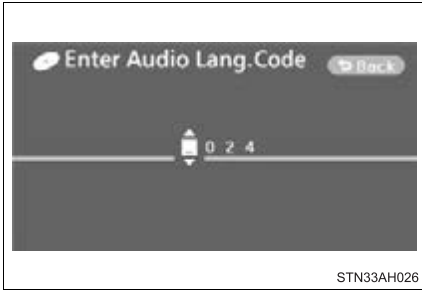

Select **Others** if you cannot find the language you would like to hear.

Enter the appropriate 4-digit language code. (→P. 410)

Select a number, and press





If a code that is not in the list is entered, "Incorrect Code" will appear on the screen.

Changing the subtitle language

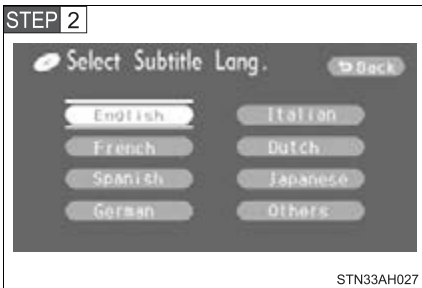
STEP 1 Select **Subtitle Language**.



Select the language you would

like to read, and press  or  to input it.

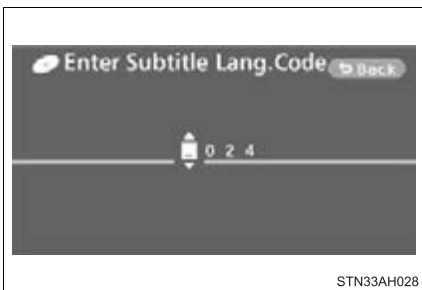

Select **Others** if you cannot find the language you would like to read.

Enter the appropriate 4-digit language code. (→P. 410)

Select a number, and press





If a code that is not in the list is entered, "Incorrect Code" will appear on the screen.

Changing the DVD language

STEP 1 Select **DVD Language**.



Select the language you would like to hear and press  or  to input it.



Select **Others** if you cannot find the language you would like to hear.

Enter the appropriate 4-digit language code. (→P. 410)



Select a number, and press

 or  to input it.

If a code that is not in the list is entered, "Incorrect Code" will appear on the screen.

Turning on/off the angle mark

The angle mark can be turned on for discs that are multi-angle compatible.

Each time you press  or  when **Angle Mark** is selected, the angle mark turns on or off.

Setting viewer restriction levels

Setting a personal code allows the viewer restriction to be used.

STEP 1 Select **Parental Lock** .

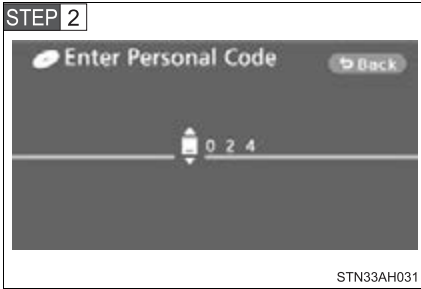

Enter a personal code and press





The setting cannot be changed unless a personal code is entered.

When you forget a personal code, initialize a personal code. (→P. 410)



Select a restriction level (1-8),

and press  or . The smaller the level number, the stricter the restrictions.

Initializing all menus

Select **Default** .

Turning off the Setup Menu screen

Select **Enter** .

Setting the display mode

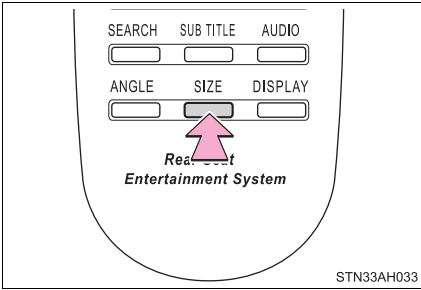

Pressing  changes the display mode sequentially as follows:

Normal → Wide 1 → Wide 2

Returning to the previous screen

Select  to return to the previous screen.

■ To initialize the password

Press ◀ on the remote controller or unit ten times when the Enter Personal Code screen is displayed.

■ Language code list

Code	Language
0514	English
0618	French
0405	German
0920	Italian
0519	Spanish
2608	Chinese
1412	Dutch
1620	Portuguese
1922	Swedish
1821	Russian
1115	Korean
0512	Greek
0101	Afar
0102	Abkhazian
0106	Afrikaans
0113	Amharic
0118	Arabic
0119	Assamese
0125	Aymara
0126	Azerbaijani
0201	Bashkir
0205	Byelorussian
0207	Bulgarian

Code	Language
0208	Bihari
0209	Bislama
0214	Bengali
0215	Tibetan
0218	Breton
0301	Catalan
0315	Corsican
0319	Czech
0325	Welsh
0401	Danish
0426	Bhutani
0515	Esperanto
0520	Estonian
0521	Basque
0601	Persian
0609	Finnish
0610	Fiji
0615	Faroese
0625	Frisian
0701	Irish
0704	Scots-Gaelic
0712	Galician
0714	Guarani

Code	Language
0721	Gujarati
0801	Hausa
0809	Hindi
0818	Croatian
0821	Hungarian
0825	Armenian
0901	Interlingua
0905	Interlingue
0911	Inupiak
0914	Indonesian
0919	Icelandic
0923	Hebrew
1001	Japanese
1009	Yiddish
1023	Javanese
1101	Georgian
1111	Kazakh
1112	Greenlandic
1113	Cambodian
1114	Kannada
1119	Kashmiri
1121	Kurdish
1125	Kirghiz
1201	Latin
1214	Lingala
1215	Laothian
1220	Lithuanian
1222	Latvian
1307	Malagasy
1309	Maori

Code	Language
1311	Macedonian
1312	Malayalam
1314	Mongolian
1315	Moldavian
1318	Marathi
1319	Malay
1320	Maltese
1325	Burmese
1401	Nauru
1405	Nepali
1415	Norwegian
1503	Occitan
1513	(Afan) Oromo
1518	Oriya
1601	Punjabi
1612	Polish
1619	Pashto, Pushto
1721	Quechua
1813	Rhaeto-Romance
1814	Kirundi
1815	Romanian
1823	Kinyarwanda
1901	Sanskrit
1904	Sindhi
1907	Sangho
1908	Serbo-Croatian
1909	Sinhalese
1911	Slovak
1912	Slovenian
1913	Samoan

Code	Language
1914	Shona
1915	Somali
1917	Albanian
1918	Serbian
1919	Siswati
1920	Sesotho
1921	Sundanese
1923	Swahili
2001	Tamil
2005	Telugu
2007	Tajik
2008	Thai
2009	Tigrinya
2011	Turkmen
2012	Tagalog

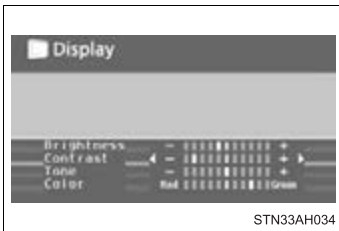

Code	Language
2014	Setswana
2015	Tonga
2018	Turkish
2019	Tsonga
2020	Tatar
2023	Twi
2111	Ukrainian
2118	Urdu
2126	Uzbek
2209	Vietnamese
2215	Volapük
2315	Wolof
2408	Xhosa
2515	Yoruba
2621	Zulu

■ Adjusting the screen



Press  .

Select the brightness, contrast, tone or color, and make adjustments. Press

 or  or  to input it.

	“-” or “Red”	“+” or “Green”
Brightness	Darkens	Brightens
Contrast	Weakens the contrast	Strengthens the contrast
Tone	Weakens the tone	Strengthens the tone
Color	Strengthens the red color	Strengthens the green color

3-5. Using the hands-free phone system (for cellular phone) Hands-free phone system features*

This system supports Bluetooth[®], which allows you to make or receive calls without using cables to connect a cellular phone and the system, and without operating the cellular phone.

Owners of models equipped with a navigation system should refer to the “Navigation System Owner’s Manual”.

■ Hands-free system quick guide

STEP 1 Setting a cellular phone. (→P. 417)

STEP 2 Adding an entry to the phonebook (Up to 20 names can be stored). (→P. 436)

STEP 3 Dialing by inputting a name. (→P. 426)

*: If equipped

Title	Page
Using the hands-free phone system <ul style="list-style-type: none"> ■ Operating the system by using a voice command ■ Using the hands-free system for the first time ■ Menu list of the hands-free phone system 	P. 417
Making a phone call <ul style="list-style-type: none"> ■ Dialing by inputting a number ■ Dialing by inputting a name ■ Speed dialing ■ When receiving a phone call ■ Transferring a call ■ Using the call history memory 	P. 425
Setting a cellular phone <ul style="list-style-type: none"> ■ Registering a cellular phone ■ Selecting the cellular phone to be used ■ Changing a registered name ■ Listing the registered cellular phone ■ Changing the passkey ■ Turning the hands-free phone automatic connection on/off 	P. 429
Security and system setup <ul style="list-style-type: none"> ■ Setting or changing the PIN ■ Locking or unlocking the phone book ■ Setting voice guidance volume ■ Initialization 	P. 433
Using the phone book <ul style="list-style-type: none"> ■ Adding a new phone number ■ Setting speed dials ■ Changing a registered names ■ Deleting registered data ■ Deleting speed dials ■ Listing the registered data 	P. 436

■ Conditions affecting operation

The hands-free phone system may not operate normally in the following situations:

- The cellular phone is turned off, or located outside the service area.
- The cellular phone has a low battery.
- The cellular phone is not connected to the system.
- The cellular phone is behind the seat or in the glove box, or metal material covers or touches the phone.

■ When transferring ownership of the vehicle

Be sure to initialize the system to prevent personal data from being improperly accessed.

■ Required profiles for the cellular phone

- HFP (Hands Free Profile) Ver. 1.0
- OPP (Object Push Profile) Ver. 1.1

■ For detailed information about Handsfree Phone System

For assistance with pairing and operating your cell phone, go to the website www.toyota.letstalk.com.

■ About Bluetooth®



Bluetooth is a registered trademark of Bluetooth SIG, Inc.

■ Certification for the hands-free phone system

FCC ID: ACJ932C5ZZZ035
 IC ID: 216J-C5ZZZ035
 MADE IN MEXICO

This device complies with Part 15 of the FCC Rules and RSS-210 Rules. Operation is subject to the following two conditions; (1) This device may not cause harmful interference, and (2) This device must accept any interference received, including interference that may cause undesired operation.

 **CAUTION**

■ **FCC WARNING**

Changes or modifications in construction not expressly approved by the party responsible for compliance could void the user's authority to operate the equipment.

Radio frequency exposure. This device is approved for Mobile Application only and, to comply with applicable FCC radio frequency exposure regulations, must be used with a distance of at least 7.9 in. (20 cm) between the antenna and the body of any person at all times during use.

■ **Caution while driving**

Do not use a cellular phone, or connect the Bluetooth[®] phone.

 **NOTICE**

■ **To prevent damage to a cellular phone**

Do not leave a cellular phone in the vehicle. The temperature inside may become high resulting in damage to the phone.

3-5. Using the hands-free phone system (for cellular phone) Using the hands-free phone system

■ Audio unit

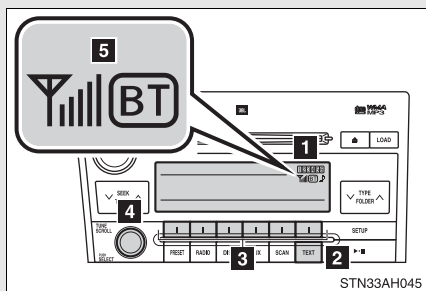

- 1** Display
A message, name, phone number, etc. is displayed.

Lower-case characters and special characters, such as an umlaut, cannot be displayed.
- 2** Displays information that is too long to be displayed at one time on the display (press and hold)
- 3** Selects speed dials
- 4** Selects items such as menu or number
Turn: Selects an item
Press: Inputs the selected item
- 5** Bluetooth® connection condition and reception level

If "BT" is not displayed, the hands-free phone system cannot be used.

■ Steering wheel

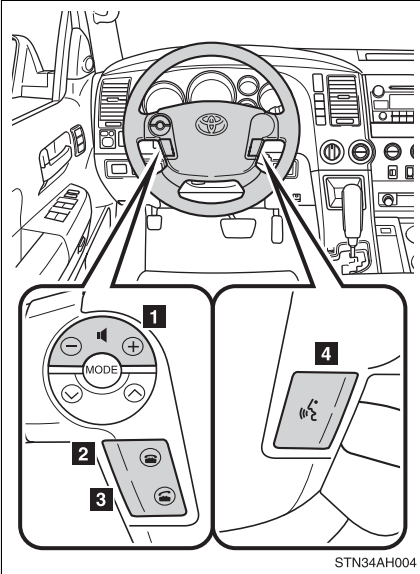

1 Volume

The voice guidance volume cannot be adjusted using this button.

2 On-hook switch

Turns the hands-free system off/ends a call/refuses a call

3 Off-hook switch

Turns the hands-free system on/starts a call

4 Talk switch

Turns the voice command system on (press)/turns the voice command system off (press and hold)

■ Microphone

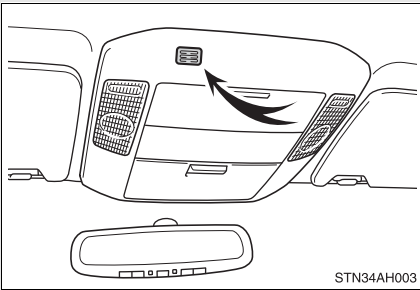

Operating the system by using a voice command

By following the voice guidance instructions output from the speaker, voice commands enable the operation of the hands-free phone system without the need to check the display or operate  .

■ Operation procedure when using a voice command

Press the talk switch and follow the voice guidance instructions.

■ Auxiliary commands when using a voice command

The following auxiliary commands can be used when operating the system using a voice command:

“Cancel”: Exits the hands-free phone system

“Repeat”: Repeats the previous voice guidance instruction

“Go back”: Returns to the previous procedure

“Help”: Reads aloud the function summary if a help comment is registered for the selected function

Using the hands-free phone system for the first time

Before using the hands-free phone system, it is necessary to register a cellular phone in the system. The phone registration mode will be entered automatically when starting the system with no cellular phone registered. Follow the procedure below to register a cellular phone:

STEP 1 Press the off-hook switch or the talk switch.

The introductory guidance and phone name registration instructions are heard.

STEP 2 Select “Pair Phone” using a voice command or  .

STEP 3 Register a phone name by either of the following methods.

a. Select “Record Name” by using  , and say a name to be registered.

b. Press the talk switch and say a name to be registered.

A voice guidance instruction to confirm the input is heard.

STEP 4 Select “Confirm” by using a voice command or



► Registration to the hands-free phone system only

STEP 5 Select “Phone Only” using a voice command or



► Registration to the hands-free phone system and Bluetooth® audio system at the same time

STEP 5 Select “Internal Audio (Int. Audio)” using a voice command or



STEP 6 Select “Confirm” by using a voice command or



A passkey is displayed and heard, and a voice guidance instruction for inputting the passkey into the cellular phone is heard.

STEP 7 Input the passkey into the cellular phone.

Refer to the manual that comes with the cellular phone for the operation of the phone.

Guidance for registration completion is heard.

Menu list of the hands-free phone system

■ Normal operation

First menu	Second menu	Third menu	Operation detail
"Callback"	-	-	Dialing a number stored in the incoming call history memory
"Redial"	-	-	Dialing a number stored in the outgoing call history memory
"Dial by number"	-	-	Dialing by inputting a number
"Dial by name"	-	-	Dialing by inputting a name registered in the phone book
"Phonebook"	"Add Entry"	-	Adding a new number
	"Change Name"	-	Changing a name in the phone book
	"Delete Entry"	-	Deleting the phone book data
	"Delete Speed Dial"	-	Deleting a registered speed dial
	"List Names"	-	Listing the phone book data
	"Set Speed Dial" (Speed Dial)	-	Registering a speed dial

3-5. Using the hands-free phone system (for cellular phone)

First menu	Second menu	Third menu	Operation detail
"Setup"	"Security"	"Set PIN"	Setting a PIN code
		"Phone-book Lock"	Locking the phone book
		"Phone-book Unlock"	Unlocking the phone book
	"Phone Setup"	"Pair Phone"	Registering the cellular phone to be used
		"Change Name"	Changing a registered name of a cellular phone
		"Delete Phone"	Deleting a registered cellular phone
		"List phones"	Listing the registered cellular phones
		"Select phone"	Selecting a cellular phone to be used
		"Set Pass-key"	Changing the passkey
		"Hands-free power"	Setting the hands-free power on/off
	"System Setup"	"Guidance Volume"	Setting voice guidance volume
		"Device Name"	Displaying device information
		"Initialize"	Initialization

■ Using a short cut key

First menu	Second menu	Operation detail
"Dial XXX (name)"	-	Dialing a number registered in the phone book
"Dial XXX (number)"	-	Dialing the input numbers
"Phone book add entry"	-	Adding a new number
"Phone book change name"	-	Changing the name of a phone number in the phone book
"Phone book delete entry"	-	Deleting phone book data
"Phone book set speed dial"	-	Registering a speed dial
"Phone book delete speed dial"	-	Deleting a speed dial
"Phonebook"	"Phonebook Unlock"	Unlocking the phone book
	"Phonebook Lock"	Locking the phone book

■ **Automatic volume adjustment**

When vehicle speed is 50 mph (80 km/h) or more, the volume automatically increases. The volume returns to the previous volume setting when vehicle speed drops to 43 mph (70 km/h) or less.

■ **When using a voice command**

For numbers, say a combination of single digits from zero to nine, # (pound), * (star), and + (plus).

Say a command correctly and clearly.

■ **The system may not recognize your voice in the following situations:**

- When driving on a rough road
- When driving at high speeds
- When air is blowing out of the vents onto the microphone
- When the air conditioning fan emits a loud noise

■ **Operations that cannot be performed while driving**

- Operating the system with 
- Registering a cellular phone to the system

■ **Changing the passkey**

→P. 432

3-5. Using the hands-free phone system (for cellular phone) Making a phone call

■ Making a phone call

- Dialing by inputting a number
“Dial by number”
- Dialing by inputting a name
“Dial by name”
- Speed dialing
- Dialing a number stored in the outgoing history memory
“Redial”
- Dialing a number stored in the incoming history memory
“Call back”

■ Receiving a phone call

- Answering the phone
- Refusing the call

■ Transferring a call

■ Using the call history memory

- Dialing
- Storing data in the phone book
- Deleting

Dialing by inputting a number

- STEP 1** Press the talk switch and say “Dial by number”.
- STEP 2** Press the talk switch and say the phone number.
- STEP 3** Dial by one of the following methods:
- Press the off-hook switch.
 - Press the talk switch and say “Dial”.
 - Select “Dial” by using 

Dialing by inputting a name

STEP 1 Press the talk switch and say “Dial by name”.

STEP 2 Select a registered name to be input by either of the following methods:

- a. Press the talk switch and say a registered name.
- b. Press the talk switch and say “List names”. Press the talk switch while the desired name is being read aloud.

STEP 3 Dial by one of the following methods:

- a. Press the off-hook switch.
- b. Press the talk switch and say “Dial”.
- c. Select “Dial” by using .

Speed dialing

STEP 1 Press the off-hook switch.

STEP 2 Press the preset button in which the desired number is registered.

STEP 3 Press the off-hook switch.

When receiving a phone call

■ Answering the phone

Press the off-hook switch.

■ Refusing the call

Press the on-hook switch.

Transferring a call

A call can be transferred between the cellular phone and system while dialing, receiving a call, or during a call. Use one of the following methods:

- a. Operate the cellular phone.
Refer to the manual that comes with the cellular phone for the operation of the phone.
- b. Press the off-hook switch*¹.
- c. Press the talk switch and say “Call Transfer”^{*2}.

*¹: This operation can be performed only when transferring a call from the cellular phone to the system during a call.

*²: While the vehicle is in motion, a call cannot be transferred from the system to the cellular phone.

Using the call history memory

Follow the procedure below to use a number stored in the call history memory:

STEP 1 Press the talk switch and say “Redial” (when using a number stored in the outgoing call history memory) or “Call back” (when using a number stored in the incoming call history memory).

STEP 2 Select the number by either of the following methods:

- a. Say “Previous” or “Go back” until the desired number is displayed.

b. Select the desired number by using  .

The following operations can be performed:

Dialing: Press the off-hook switch or select “Dial” by using a voice command or  .

Storing the number in the phone book: Select “Store” by using a voice command or  .

Deleting: Select “Delete” by using a voice command or  .

■ **Call history**

Up to 5 numbers can be stored in each of the outgoing and incoming call history memories.

■ **When talking on the phone**

- Do not talk simultaneously with the other party.
- Keep the volume of the received voice down. Otherwise, voice echo will increase.

3-5. Using the hands-free phone system (for cellular phone) Setting a cellular phone

Registering a cellular phone in the hands-free phone system allows the system to function. The following functions can be used for registered cellular phones:

■ Functions and operation procedures

To enter the menu for each function, follow the steps below by using a voice command or  :

- Registering a cellular phone
 1. "Setup" → 2. "Phone Setup" → 3. "Pair Phone"
- Selecting the cellular phone to be used
 1. "Setup" → 2. "Phone Setup" → 3. "Select Phone"
- Changing a registered name
 1. "Setup" → 2. "Phone Setup" → 3. "Change Name"
- Listing the registered cellular phones
 1. "Setup" → 2. "Phone Setup" → 3. "List Phones"
- Deleting a cellular phone
 1. "Setup" → 2. "Phone Setup" → 3. "Delete Phone"
- Changing the passkey
 1. "Setup" → 2. "Phone Setup" → 3. "Set Passkey"
- Turning the hands-free phone automatic connection on/off
 1. "Setup" → 2. "Phone Setup" → 3. "Hands-free power"

Registering a cellular phone

Select "Pair Phone" by using a voice command or , and do the procedure for registering a cellular phone. (→P. 419)

Selecting the cellular phone to be used

STEP 1 Select “Select Phone” by using a voice command or  .

► Pattern A

STEP 2 Select the cellular phone to be used by either of the following methods, and select “Confirm” by using a voice command or



- Press the talk switch and say the desired phone name.
- Press the talk switch and say “List phones”. While the name of the desired cellular phone is being read aloud, press the talk switch.

► Pattern B

STEP 2 Select the cellular phone to be used by using  .

Changing a registered name

STEP 1 Select “Change Name” by using a voice command or  .

STEP 2 Select the name of the cellular phone to be changed by either of the following methods:

- Press the talk switch and say the desired phone name, and select “Confirm” by using a voice command or  .
- Press the talk switch and say “List phones”. While the desired phone name is being read aloud, press the talk switch.

c. Select the desired phone name by using  .

STEP 3 Press the talk switch or select “Record Name” by using



STEP 4 Select “Confirm” by using a voice command or



Listing the registered cellular phones

Selecting “List Phones” by using a voice command or



causes

the list of registered cellular phones to be read aloud.

When listing is complete, the system returns to “Phone Setup”.

Pressing the talk switch while the name of a cellular phone is being read selects the cellular phone, and the following functions will be available:

- Selecting a cellular phone: “Select Phone”
- Changing a registered name: “Change Name”
- Deleting a cellular phone: “Delete Phone”

Deleting a cellular phone

STEP 1 Select “Delete Phone” by using a voice command or





STEP 2 Select the cellular phone to be deleted by either of the following methods and select “Confirm” by using a voice command

or  :

- a. Press the talk switch and say the name of the desired cellular phone.
- b. Press the talk switch and say “List phones”. While the name of the desired cellular phone is being read aloud, press the talk switch.

Changing the passkey

STEP 1 Select “Set Passkey” by using a voice command or  .

STEP 2 Press the talk switch, say a 4 to 8-digit number, and select “Confirm” by using a voice command or  .

The number should be input 1 digit at a time.

STEP 3 When the entire number to be registered as a passkey has been input, press  again.

Turning the hands-free phone automatic connection on/off

■ Turning off the automatic connection

STEP 1 Select “Handsfree Power” by using a voice command or  .

STEP 2 Select “Turn off” by using a voice command or  .

■ Turning on the automatic connection

STEP 1 Select “Handsfree Power” by using a voice command or  .

STEP 2 Select “Turn on” by using a voice command or  .

■ The number of cellular phones that can be registered

Up to 6 cellular phones can be registered in the system.

To enter the menu of each setting, follow the steps below:

■ **Security setting items and operation procedure**

- Setting or changing the PIN (Personal Identification Number)
 1. “Setup” → 2. “Security” → 3. “Set PIN”
- Locking the phone book
 1. “Setup” → 2. “Security” → 3. “Phonebook Lock”
- Unlocking the phone book
 1. “Setup” → 2. “Security” → 3. “Phonebook Unlock”

■ **System setup items and operation procedure**

- Setting voice guidance volume
 1. “Setup” → 2. “System Setup” → 3. “Guidance Volume”
- Displaying the Bluetooth[®] device address and name
 1. “Setup” → 2. “System Setup” → 3. “Device name”
- Initialization
 1. “Setup” → 2. “System Setup” → 3. “Initialize”





can only be used for system setup operation.

Setting or changing the PIN

■ **Setting a PIN**

STEP 1 Select “Set PIN” by using a voice command or .

STEP 2 Enter a PIN by using a voice command or .

When using , input the code 1 digit at a time.

■ Changing the PIN

STEP 1 Select “Set PIN” by using a voice command or  .

STEP 2 Enter the registered PIN by using a voice command or  .

STEP 3 Enter a new PIN by using a voice command or  .

When using  , input the code 1 digit at a time.

Locking or unlocking the phone book

STEP 1 Select “Phonebook lock” or “Phonebook unlock” by using a voice command or  .

STEP 2 Input the PIN by either of the following methods and select “Confirm” by using a voice command or  :

a. Press the talk switch and say the registered PIN.

b. Input a new PIN by using  .

Setting voice guidance volume

STEP 1 Select “Guidance Volume” by using  .

STEP 2 Change the voice guidance volume.

To decrease the volume: Turn  counterclockwise.

To increase the volume: Turn  clockwise.

Displaying the Bluetooth® device address and name

STEP 1 Select “Device Name” using  .

STEP 2 Turn  to display the Bluetooth® device address and name.

STEP 3 Select “Go Back” using  to return to “System Setup”

Initialization

STEP 1 Select “Initialize” and then “Confirm” by using  .

STEP 2 Select “Confirm” by using  .

■ Initialization

- The following data in the system can be initialized:
 - Phone book
 - Outgoing and incoming call history
 - Speed dials
 - Registered cellular phone data
 - Security code
- Once the initialization has been completed, the data cannot be restored to its original state.

■ When the phone book is locked

The following functions cannot be used:

- Dialing by inputting a name
- Speed dialing
- Dialing a number stored in the call history memory
- Using the phone book

Using the phone book

To enter the menu of each setting, follow the steps below:

- Adding a new phone number
 1. "Phonebook" → 2. "Add Entry"
- Setting speed dial
 1. "Phonebook" → 2. "Set Speed Dial (Speed Dial)"
- Changing a registered name
 1. "Phonebook" → 2. "Change Name"
- Deleting registered data
 1. "Phonebook" → 2. "Delete Entry"
- Deleting speed dial
 1. "Phonebook" → 2. "Delete Speed Dial"
- Listing the registered data
 1. "Phonebook" → 2. "List Names"

Adding a new phone number

The following methods can be used to add a new phone number:

- Inputting a phone number by using a voice command
- Transferring data from the cellular phone
- Inputting a phone number by using 
- Selecting a phone number from outgoing or incoming call history

■ Adding procedure

STEP 1 Select “Add Entry” by using a voice command or  .

STEP 2 Use one of the following methods to input a telephone number:

- ▶ Inputting a telephone number by using a voice command

STEP2-1 Select “By Voice” by using a voice command or



STEP2-2 Press the talk switch, say the desired number, and select “Confirm” by using a voice command.

- ▶ Transferring data from the cellular phone

STEP2-1 Select “By Phone” and then “Confirm” by using a voice command or  .

STEP2-2 Transfer the data from the cellular phone.

Refer to the manual that comes with the cellular phone for the details of transferring data.

STEP2-3 Select the data to be registered by either of the following methods:

- Say “Previous” or “Next” until the desired data is displayed, and select “Confirm” by using a voice command.

- Select the desired data by using  .

- ▶ Inputting a phone number by using 

STEP2-1 Select “Manual Input” by using  .

STEP2-2 Input a phone number by using  , and press

 once again.

Input the phone number 1 digit at a time.

► Selecting a phone number from outgoing or incoming call history

STEP2-1 Select “Call History” by using a voice command or



STEP2-2 Select “Outgoing” or “Incoming” by using a voice

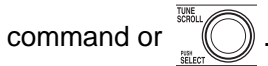

STEP2-3 Select the data to be registered by either of the following methods:

- a. Say “Previous” or “Go back” until the desired data is displayed, and select “Confirm” by using a voice command.

- b. Select the desired data by using

STEP 3 Select the name to be registered by either of the following methods, and select “Confirm” by using a voice command or



a. Press the talk switch and say the desired name.

- b. Select “Record Name” by using , and say the desired name.

STEP 4 Select “Confirm” by using a voice command or

In **STEP 3**, selecting “Set Speed Dial (Speed Dial)” instead of “Confirm” registers the newly added phone number as a speed dial.

Setting speed dials

STEP 1 Select “Set Speed Dial (Speed Dial)” by using a voice command or  .

STEP 2 Select the data to be registered as a speed dial by either of the following methods:

a. Press the talk switch, say desired number, and select

“Confirm” by using a voice command or  .

b. Press the talk switch, and say “List names”. While the desired name is being read aloud, press the talk switch,

and select “Confirm” by using a voice command or  .

c. Select the desired data by using  .

STEP 3 Select the desired preset button, and register the data into speed dial by either of the following methods:

a. Press the desired preset button, and select “Confirm” by using a voice command or  .

b. Press and hold the desired preset button.

Changing a registered name

STEP 1 Select “Change Name” by using a voice command or  .

STEP 2 Select the name to be changed by either of the following methods.

a. Press the talk switch, say desired name, and select “Confirm” by using a voice command or  .

b. Press the talk switch, and say “List names”. While the desired name is being read aloud, press the talk switch and select “Confirm” by using a voice command or  .

c. Select the desired name by using  .

STEP 3 Select “Record Name” with  or the talk switch.

STEP 4 Say a new name, and select “Confirm” by using a voice command or  .

Deleting registered data

STEP 1 Select “Delete Entry” by using a voice command or  .

STEP 2 Select the data to be deleted by either of the following methods, and select “Confirm” by using a voice command or



a. Press the talk switch, and say the name of the desired phone number to be deleted.

b. Press the talk switch and say “List phones”. While the name of the desired phone number is being read aloud, press the talk switch.

Deleting speed dials

STEP 1 Select “Delete Speed Dial” by using a voice command or



STEP 2 Press the preset button for which the desired speed dial is registered, and select “Confirm” by using a voice command or



Listing the registered data

Selecting “List names” by using a voice command causes a list of the registered data to be read aloud.

When listing is complete, the system returns to “Phonebook”.

Pressing the talk switch while the desired data is being read aloud selects the data, and the following functions will be available.

- Dialing: “Dial”
- Changing a registered name: “Change Name”
- Deleting an entry: “Delete Entry”
- Setting a speed dial: “Set Speed Dial (Speed Dial)”

■ Limitation of number of digits

A phone number that exceeds 24 digits cannot be registered.

3-6. Using the interior lights

Interior lights list

Your Toyota is equipped with an illuminated entry system to assist in entering the vehicle. Due to the function of the system, the lights shown in the following illustration automatically turn on/off according to whether the doors are locked/unlocked, whether the doors are opened/closed, and the engine switch position.

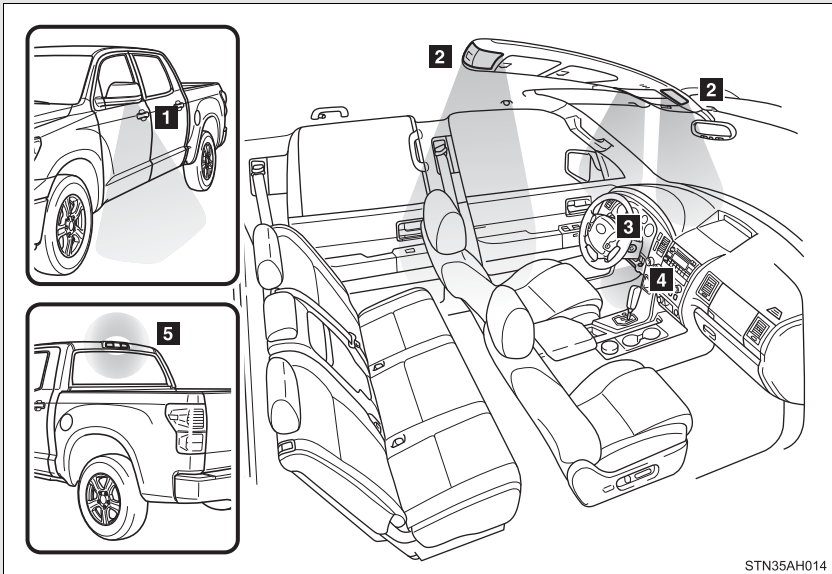

- 1** Outer foot lights (if equipped)
- 2** Personal/interior lights (→P. 444)
- 3** Engine switch light (if equipped)
- 4** Foot well lighting (if equipped)
- 5** Cargo lamp (→P. 446)

■ To prevent the battery from being discharged

▶ Personal/interior light

If the interior/personal lights remain on when a door is not fully closed and the personal/interior light main switch is in the DOOR position, the lights will turn off automatically after 20 minutes.

▶ Cargo lamp

If the cargo lamp remains on when a door is not fully closed and the cargo lamp main switch is in the DOOR position, the lights will turn off automatically after 20 minutes.

■ Customization

- That can be configured at Toyota dealer (vehicles without multi-information display)
- Settings (e.g. The time elapsed before lights turn off) can be changed. (Customizable features →P. 684)
- It is possible to change the settings (vehicles with multi-information display) (Feature customization →P. 206)

Personal/interior light main switch

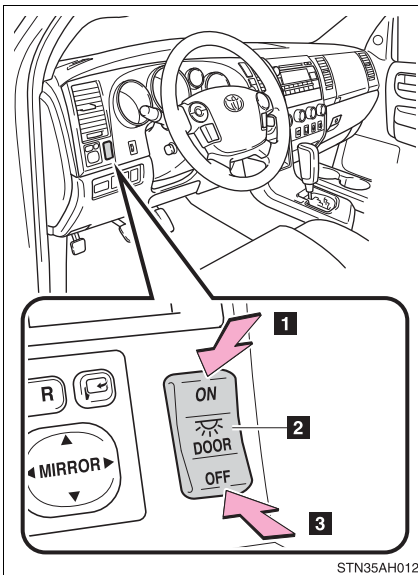

1 ON

The personal/interior lights cannot be individually turned off.

2 DOOR position

The personal/interior lights come on when a door is opened. They turn off when the doors are closed.

3 OFF

The personal/interior lights can be individually turned on or off.

Personal/interior lights

► Front (type A)

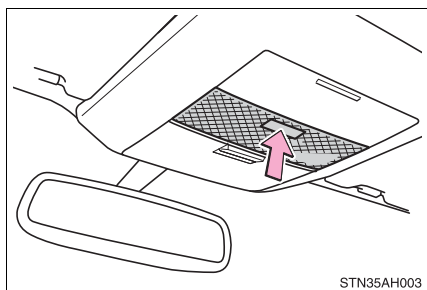

On/off

► Front (type B)

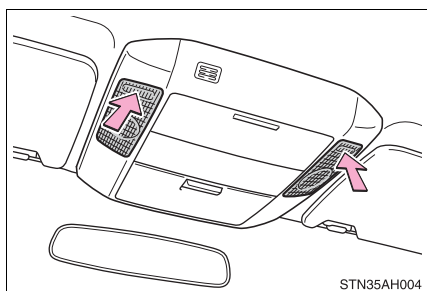

On/off

► Front (type C)

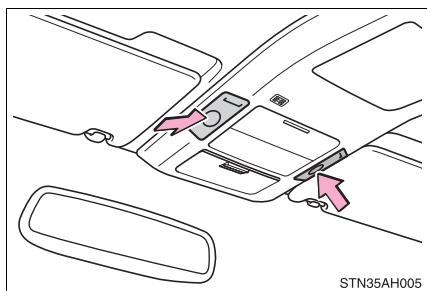

On/off

► Rear (type A)

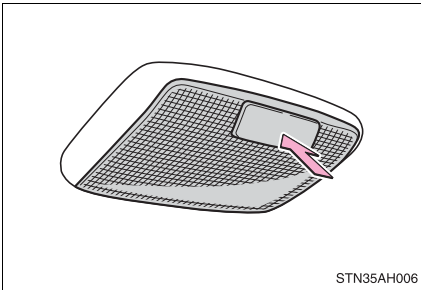

On/off

► Rear (type B)

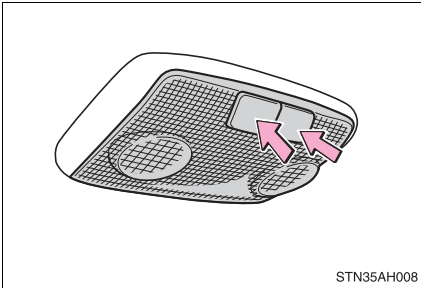

On/off

► Rear (type C)

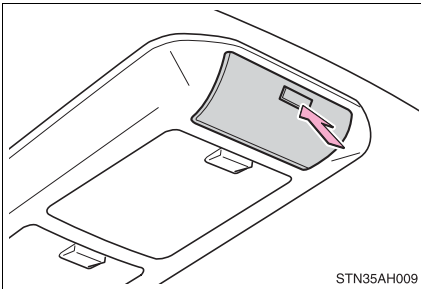

On/off

► Rear (type D)

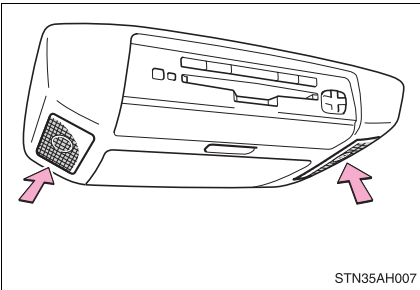

On/off

Cargo lamp main switch

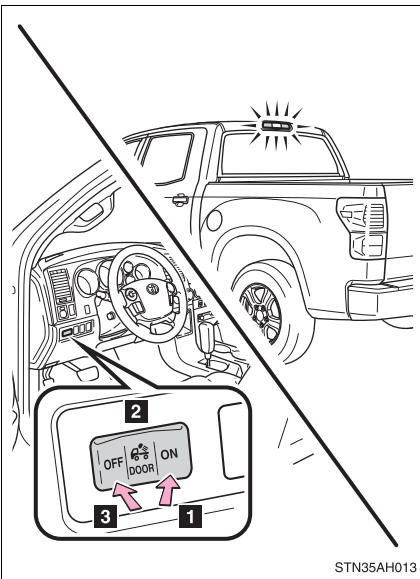

1 ON

The cargo lamp can not be individually turned off.

2 Door position

The cargo lamp comes on when a door is opened. They turn off when the doors are closed.

3 OFF

The cargo lamp can be individually turned on or off.

3-7. Using the storage features

List of storage features

► Front separated type seats

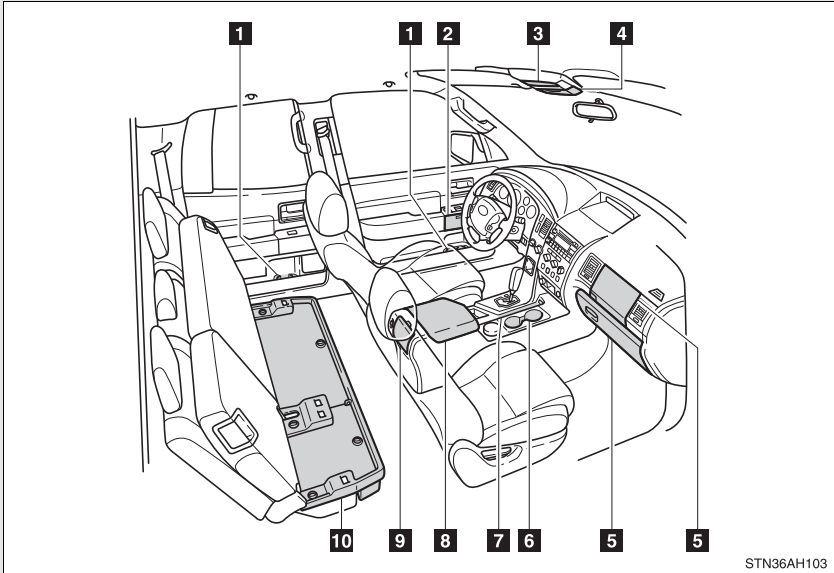

- 1** Bottle holders
- 2** Auxiliary boxes (if equipped)
- 3** Card holder (if equipped)
- 4** Overhead console (if equipped)
- 5** Glove boxes
- 6** Front cup holders
- 7** Map holder
- 8** Console box
 - Card holder
 - Map holder
 - Pen holder
 - Tissue pocket
- 9** Rear cup holders (if equipped)
- 10** Storage box (if equipped)

► Front bench type seat

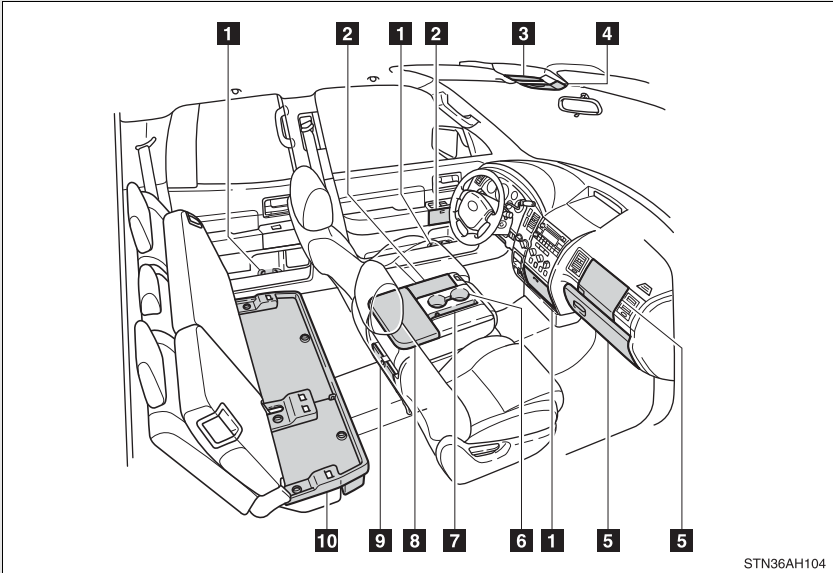

- 1** Bottle holders
- 2** Auxiliary boxes
- 3** Card holder (if equipped)
- 4** Overhead console
- 5** Glove boxes
- 6** Front cup holders
- 7** Pen holder
- 8** Auxiliary box
 - Card holder
 - Map holder
 - Tissue pocket
- 9** Rear cup holders (if equipped)
- 10** Storage box (if equipped)

Glove boxes

► Upper glove box

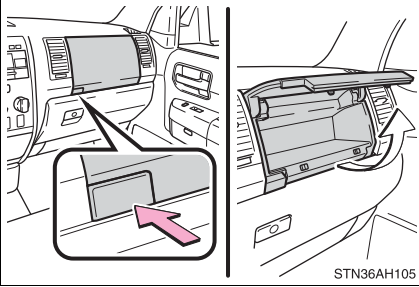

Press the button.

► Lower glove box

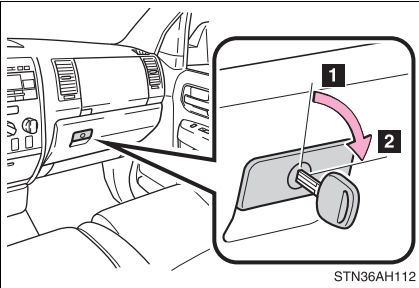

1 Unlock with the master key

2 Lock with the master key

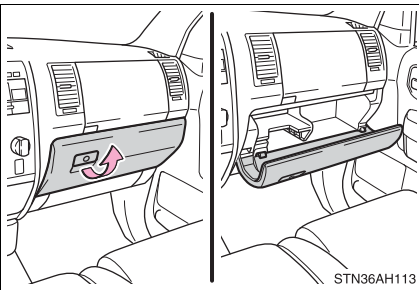

Pull the lever up.

⚠ CAUTION**■ Items that should not be left in the upper glove box**

Do not leave glasses or lighters in the box.

If the interior of the vehicle become hot, lighters may explode and glasses may warp or becomes cracked.

■ Caution while driving

Keep the glove box closed.

Injuries may result in the event of an accident or sudden braking.

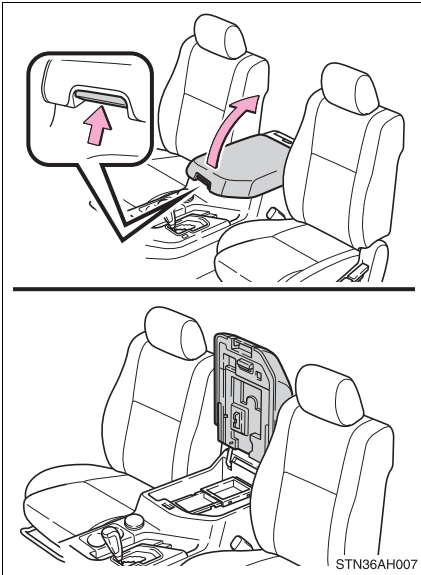
Console box (front separated type seats only)

Pull the knob up and lift the lid.

■ When using the console box lid as an armrest

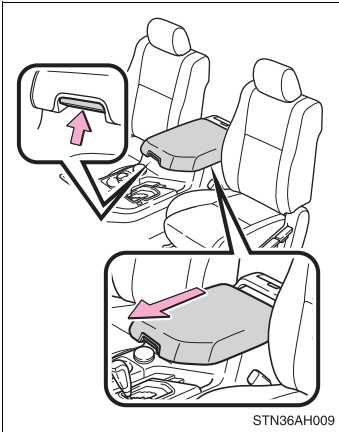

Pull the knob up and slide the lid forward.

If necessary, the console box lid can slide forward. Pull the lid forward by grasping the front of the lid.

When the lid is forward, it cannot be lifted.

■ Tray in the console box

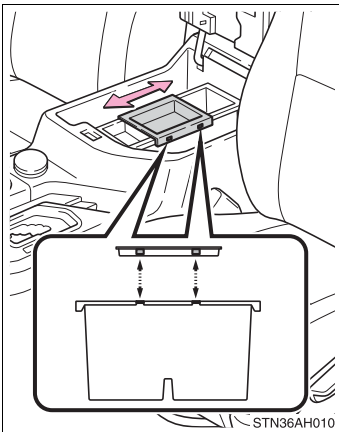

The tray slides forward or backward. The tray can be removed.

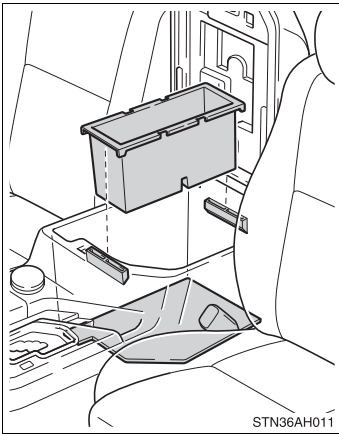

The box can be removed. Hanging file folders can be hung on the rails when the box is removed.

⚠ CAUTION

■ Caution while driving

Keep the console box closed.

Injuries may result in the event of an accident or sudden braking.

Card holder

► Overhead console (type A)

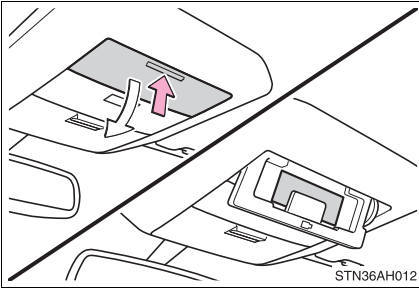

Press the lid.

► Overhead console (type B)

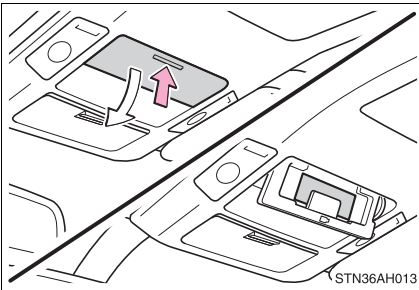

Press the lid.

► Console box (front separated type seats)

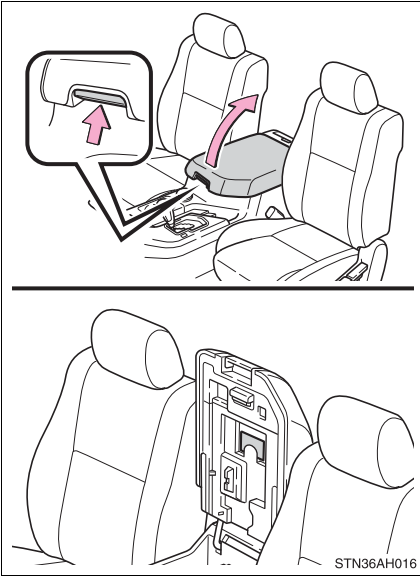

Pull the knob up and lift the lid.

► Back of the front center seatback (front bench type seat)

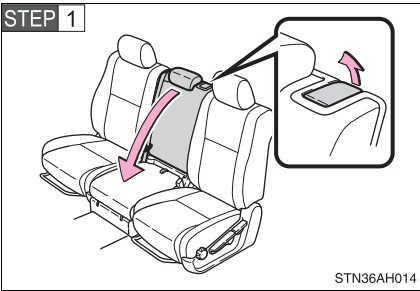

Pull the lever up and fold down the seatback.

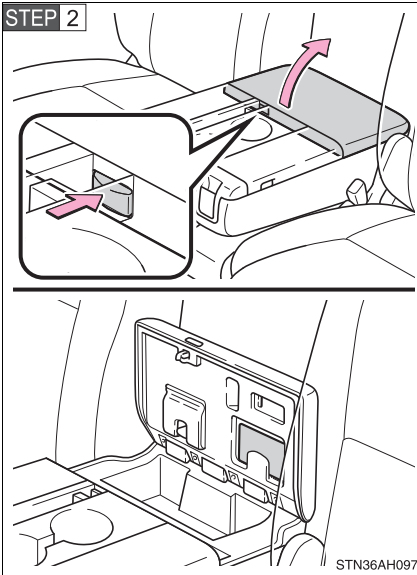

Push the knob and lift the lid.

CAUTION

Caution while driving

Keep the auxiliary box, console box or holder closed.
Injuries may result in the event of an accident or sudden braking.

Map holder

► Center console (front separated type seats)

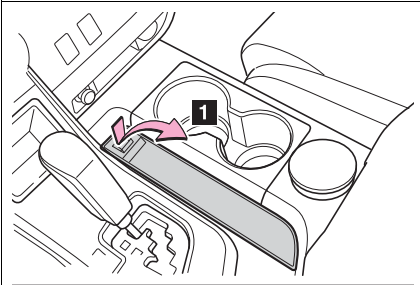

1 Push the tab down to release the lock and remove the lid.

2 Stow the lid.

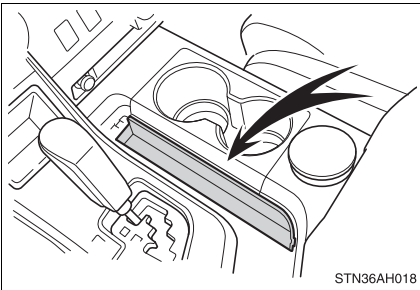
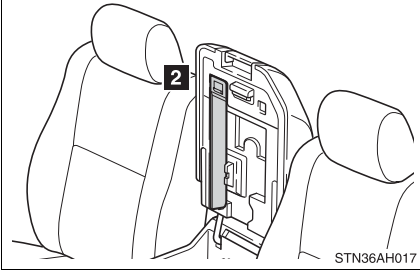

► Console box (front separated type seats)

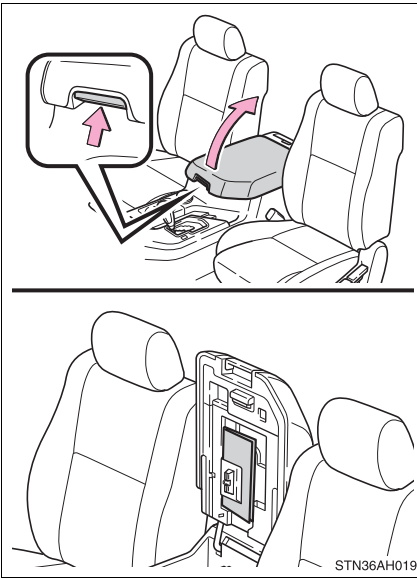

Pull the lever up and lift the lid.

► Back of the front center seatback (front bench type seat)

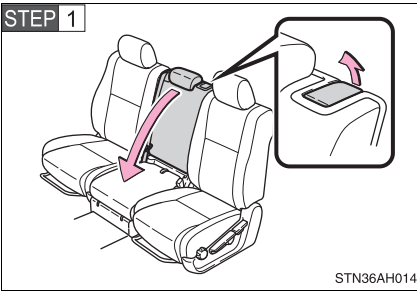

Pull the lever up and fold down the seatback.

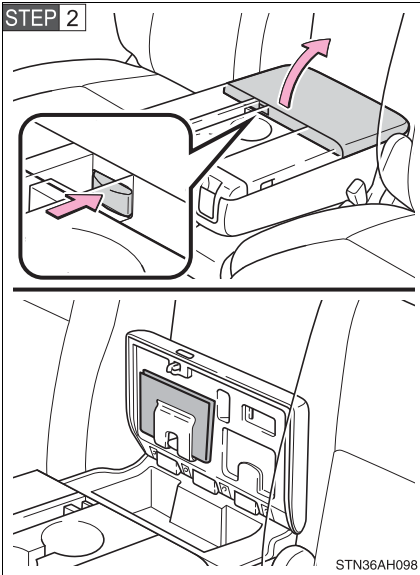

Push the knob and lift the lid.

⚠ CAUTION

■ Caution while driving

Keep the auxiliary or console box closed.

Injuries may result in the event of an accident or sudden braking.

Pen holder

► Front separated type seats

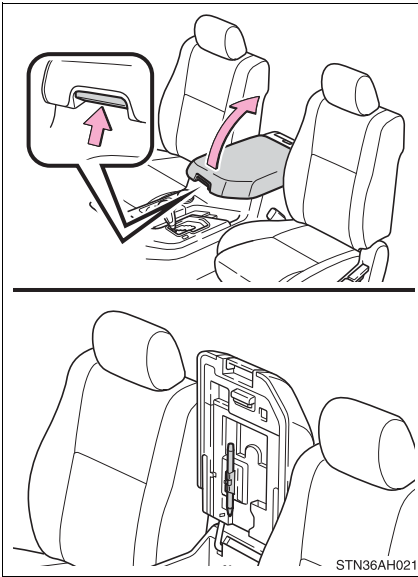

Pull the knob up and lift the lid.

► Front bench type seat

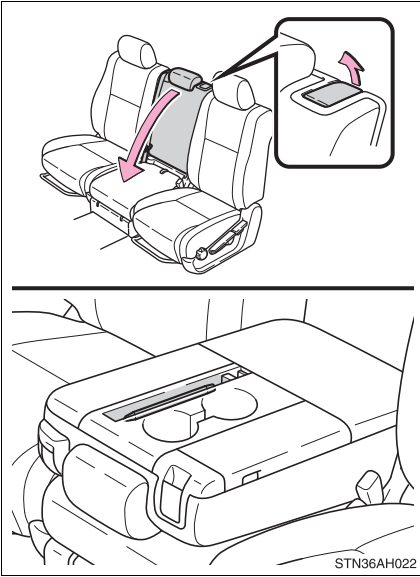

Pull the lever up and fold down the seatback.

⚠ CAUTION

■ Caution while driving (front separated type seats only)

Keep the console box closed.

Injuries may result in the event of an accident or sudden braking.

Tissue pocket

► Front separated type seats

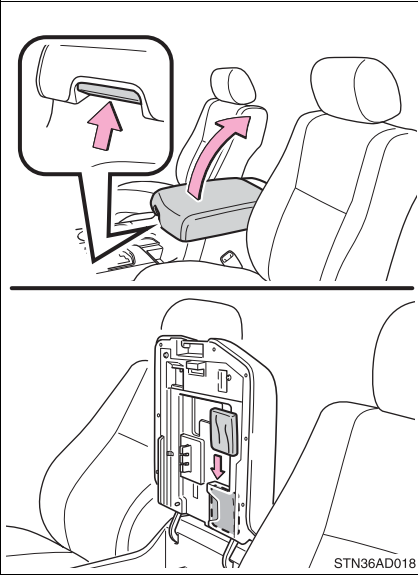

Pull the knob up and lift the lid.

► Front bench type seat

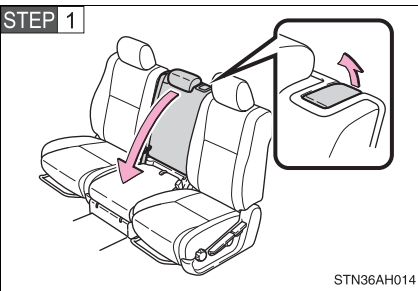

Pull the lever up and fold down the seatback.

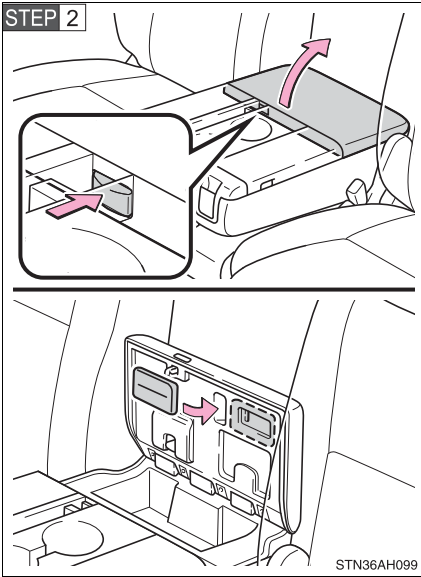

Push the knob and lift the lid.

⚠ CAUTION

■ Caution while driving

Keep the auxiliary or console box closed.

Injuries may result in the event of an accident or sudden braking.

Overhead console

The overhead console is useful for temporarily storing sunglasses and similar small items.

► Type A

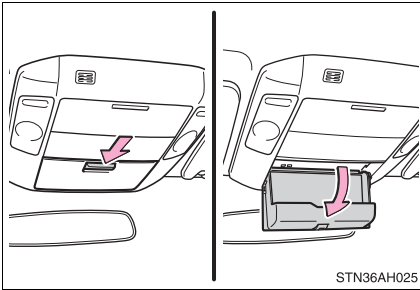

Push the knob forward to open the console.

► Type B

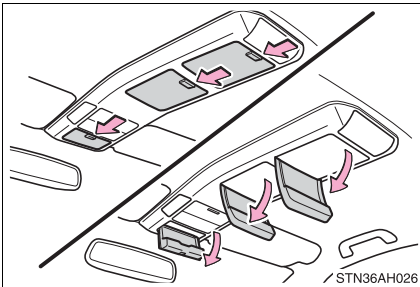

Push the knob forward to open the console.

⚠ CAUTION

■ Items that should not be left in the overhead console

Do not leave glasses or lighters in the console.

If the interior of the vehicle become hot, lighters may explode and glasses may warp or becomes cracked.

■ Caution while driving

Do not leave the overhead console open while driving.

Items stored in it may fall out and cause injury.

Front cup holders

► Separated type seats

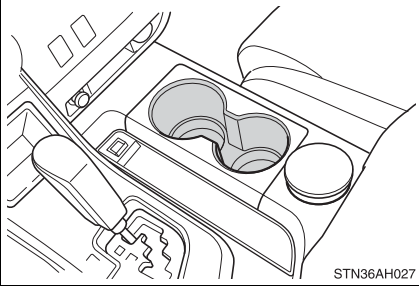

► Bench type seat

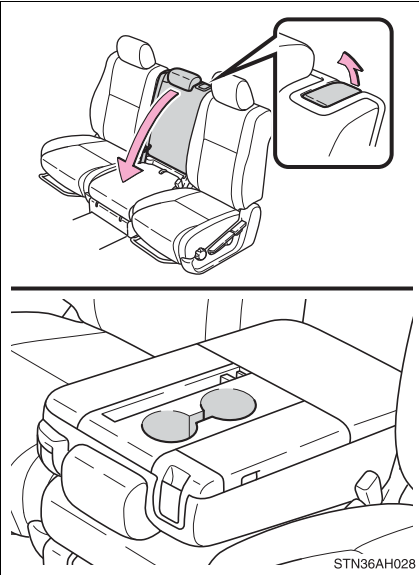

Pull the lever up and fold down the seatback.

■ Removing the cup holder (separated type seats only)

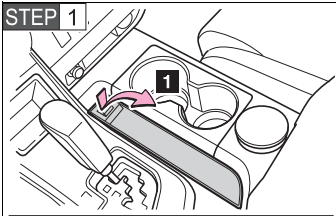

1 Push the tab down to release the lock and remove the lid.

2 Stow the lid.

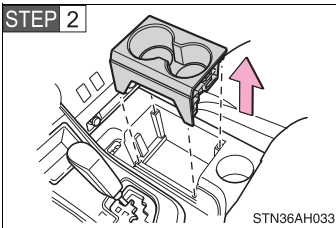
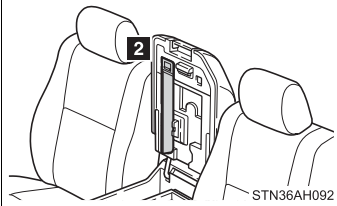

Pull the cup holder up and remove it.

⚠ CAUTION

■ Items unsuitable for the cup holder

Do not place anything other than cups or aluminum cans in the cup holders. Other items may be thrown out of the holders in the event of an accident or sudden braking and cause injury. If possible, cover hot drinks to prevent burns.

Rear cup holders

- ▶ Double Cab models with front separated type seats

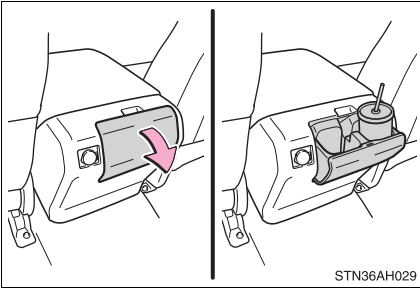

Pull the lid down.

- ▶ Double Cab models with front bench type seat

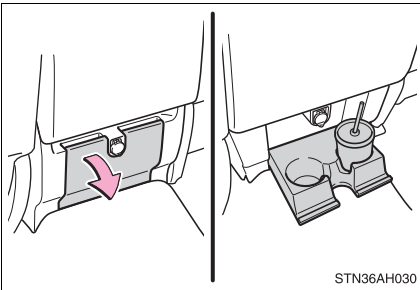

Pull the lid down.

- ▶ CrewMax models

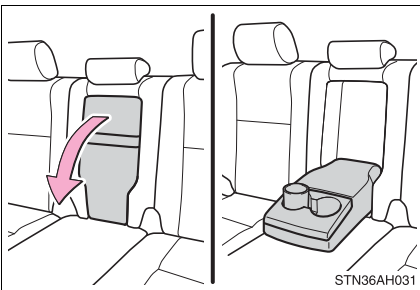

Pull the armrest down.

⚠ CAUTION**■ Items unsuitable for the cup holder**

Do not place anything other than cups or aluminum cans in the cup holders. Other items may be thrown out of the holders in the event of an accident or sudden braking and cause injury. If possible, cover hot drinks to prevent burns.

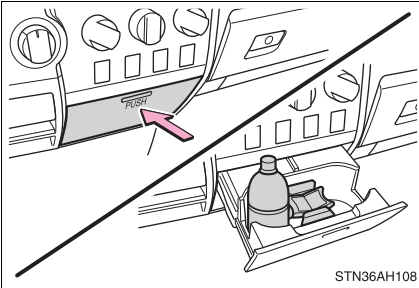
Bottle holders**► Instrument panel (front bench type seat)**

Push the lid.

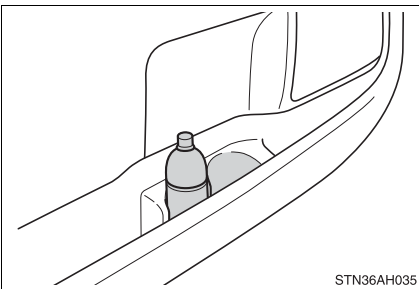
► Front door

► Rear door (type A)

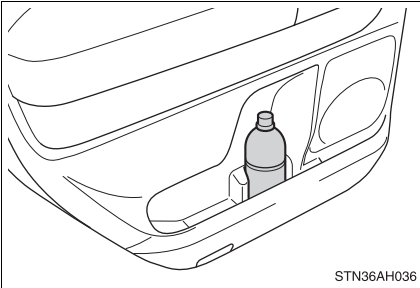

► Rear door (type B)

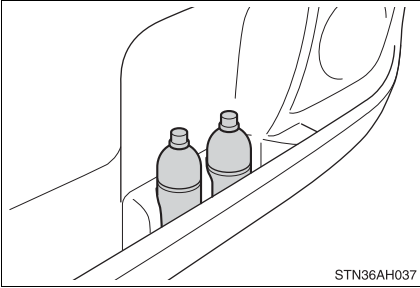

■ Removing the hold separator (front bench type seat only)

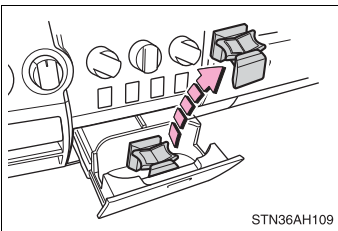

Remove the hold separator.

⚠ CAUTION

■ **When not in use (front bench type seat only)**

Keep the bottle holders closed.
Injuries may result in the event of an accident or sudden braking.

 NOTICE

Items that should not be stowed in the bottle holders.

Put the cap on before stowing a bottle. Do not place open bottles in the bottle holders, or glasses and paper cups containing liquid. The contents may spill and glasses may break.

Auxiliary boxes

► Front door

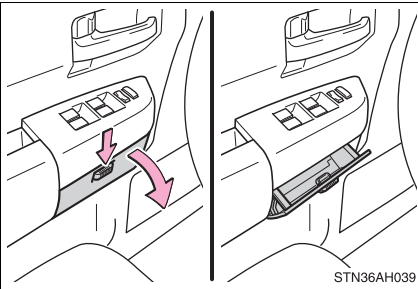

Press the knob and open the lid.

► Front bench type seat (type A)

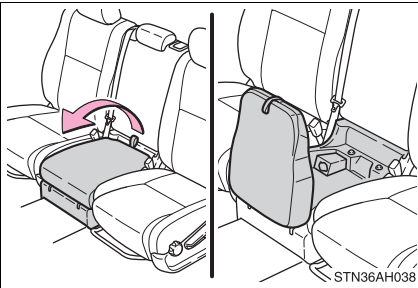

Pull the strap.

► Front bench type seat (type B)

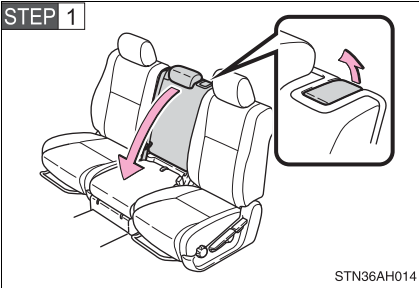

Pull the lever up and fold down the seatback.

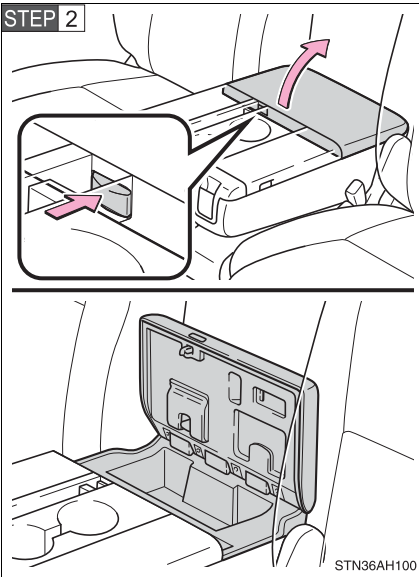

Push the knob and lift the lid.

► Front bench type seat (type C)

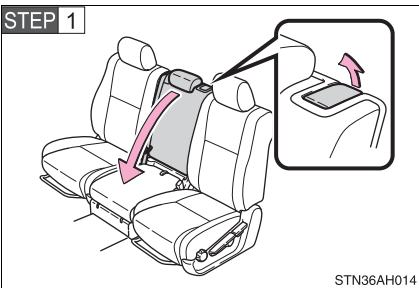

Pull the lever up and fold down the seatback.

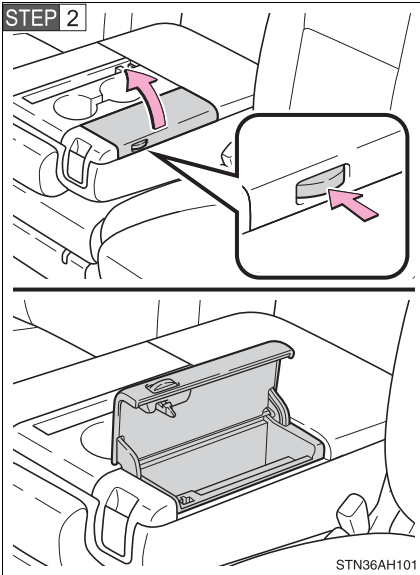

Push the knob and lift the lid.

⚠ CAUTION

■ Caution while driving

Keep the auxiliary boxes closed.
Injuries may result in the event of an accident or sudden braking.

Storage box (if equipped)

■ Using the storage box

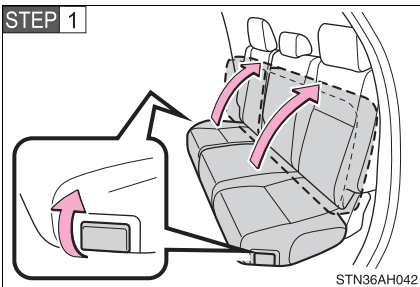

Pull the lever up and raise the rear seat cushion.

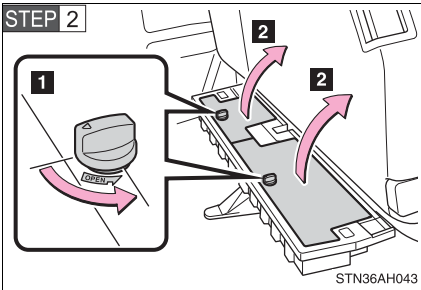

- 1 Turn the knob in the OPEN direction.
- 2 Lift the lid.

■ Remove the storage box

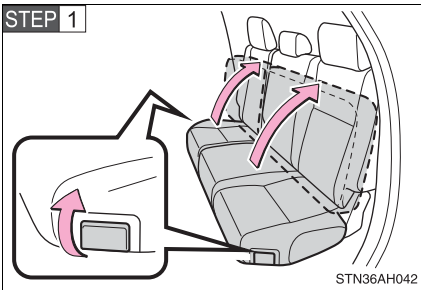

- Pull the lever up and raise the rear seat cushion.

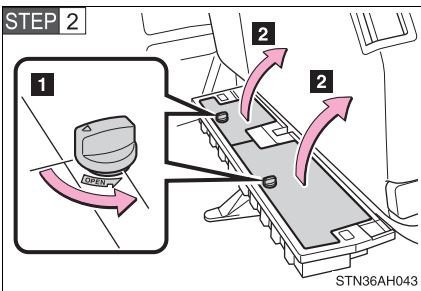

- 1 Turn the knob in the OPEN direction.
- 2 Lift the lid.

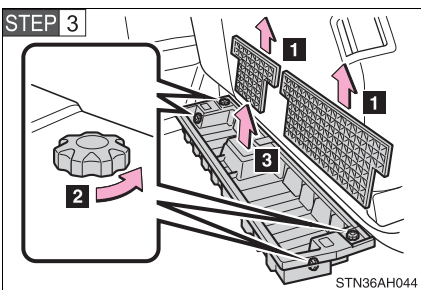

- 1 Remove the lids.
- 2 Turn the knobs clockwise.
- 3 Remove the storage box.

 **CAUTION****■ Caution while driving**

Keep the storage box lids closed.
Injuries in the event of an accident or sudden braking.

■ To prevent damage to the storage box

Do not put heavy loads on the lids.

Sun visors

■ Main visor

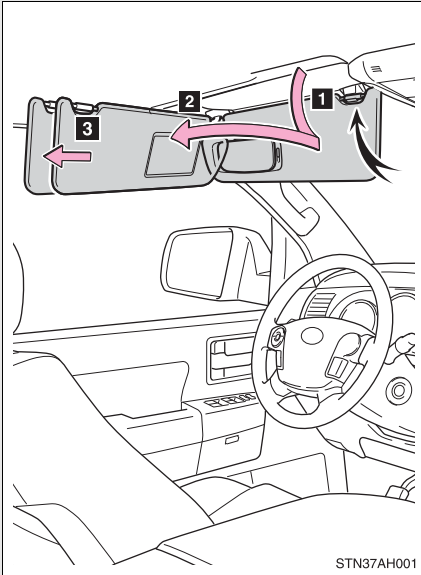

1 Forward position:

Flip down.

2 Side position:

Flip down, unhook, and swing to the side.

3 Side extender:

Place in side position then slide backwards.

■ Sub visor (if equipped)

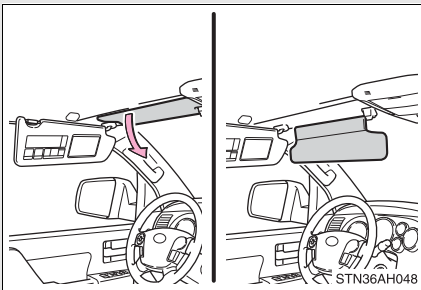

Flip down.

Vanity mirrors*

► Vehicles without vanity light

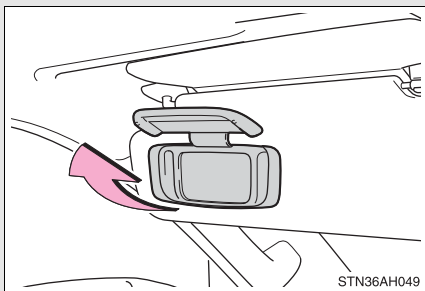

Open the cover.

► Vehicles with vanity light

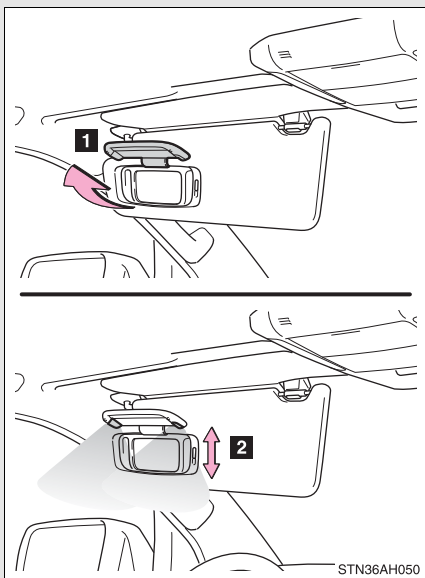

1 Open the cover.

The light turns on when the cover is opened.

2 Adjust the brightness of the light.

*: If equipped

Clock

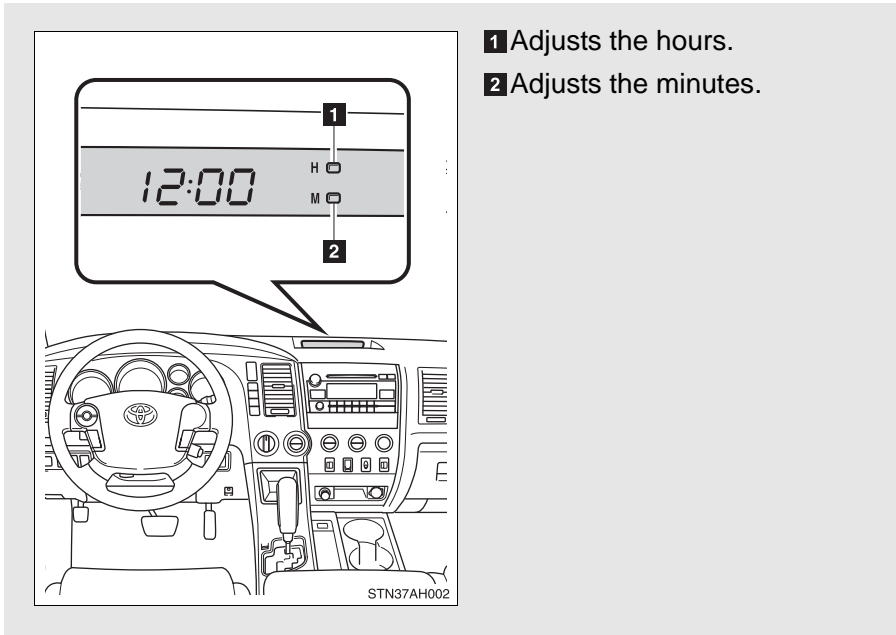

■ **For quicker adjustment of the clock (if equipped)**

Hold down the M or H button continuously. This allows faster advancement of the minutes and hours.

■ **The clock is displayed when**

The engine switch is in the ACC or ON position.

■ **When disconnecting and reconnecting battery terminals**

The time display will automatically be set to 1:00.

Outside temperature display*

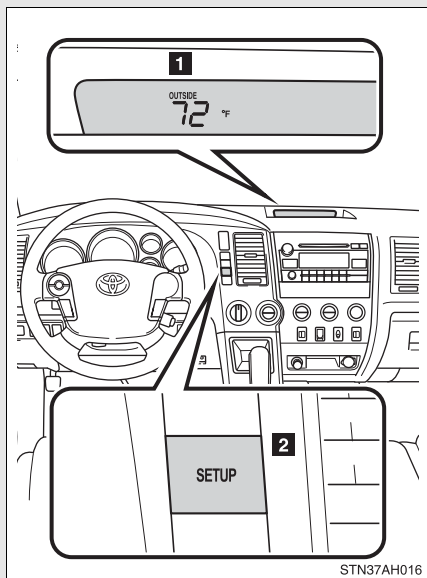

- 1 Displays the outside air temperature.

The temperature range that can be displayed is from -40°F (-40°C) to 122°F (50°C).

- 2 Switches the outside air temperature display between °C (Celsius) and °F (Fahrenheit). (if equipped)

Vehicles without multi-information display:

Push the SETUP button until the desired unit of measurement is displayed.

Vehicles with multi-information display:

With the customized unit-change operation for the multi-information display, the unit of measurement can be changed. (→P. 212)

*: If equipped

■ **When --°C or --°F is displayed**

The system may be malfunctioning. Take your vehicle to your Toyota dealer.

■ **The outside air temperature is displayed when**

The engine switch is in the ON position.

■ **When disconnecting and reconnecting battery terminals**

The display will automatically be set to the initial mode.

■ **Display**

In the following situations, the correct outside temperature may not be displayed, or the display may take longer than normal to change.

- When stopped, or driving at low speeds (less than 12 mph [20 km/h])
- When the outside temperature has changed suddenly (at the entrance/exit of a garage, tunnel, etc.)

Ashtray

▶ Front separated type seats

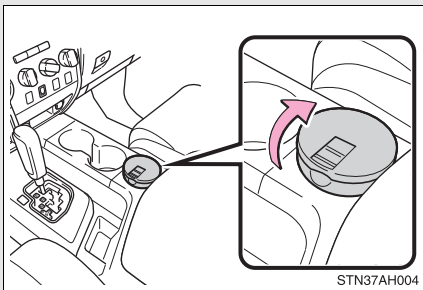

The ashtray can be installed in a cup holder.

▶ Front bench type seat

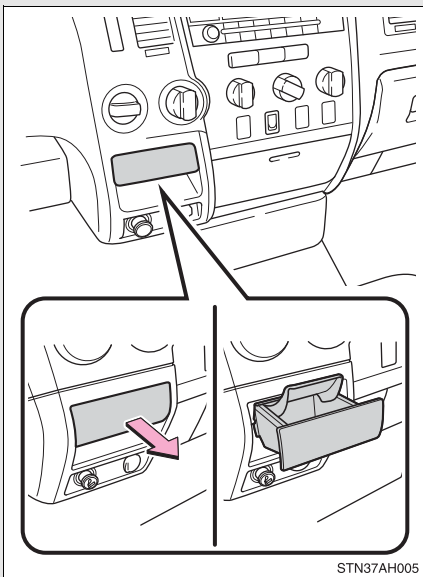

Pull the ashtray out.

■ **The ashtray can be removed**

▶ **Front separated type seats**

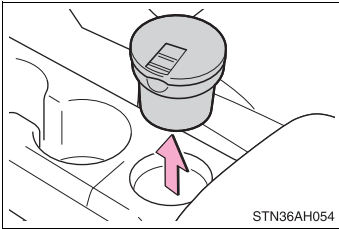

Pull the ashtray out.

▶ **Front bench type seat**

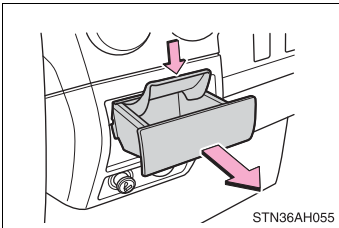

Push down on the lock spring plate and pull out.

⚠ CAUTION

■ **When not in use**

Keep the ashtray closed.

Injuries may result in the event of sudden braking, sudden swerving or an accident.

■ **To prevent fire**

- Fully extinguish matches and cigarettes before putting them in the ashtray, and then make sure the ashtray is fully closed.
- Do not place paper or any other type of flammable object in the ashtray.

Cigarette lighter

▶ Front separated type seats

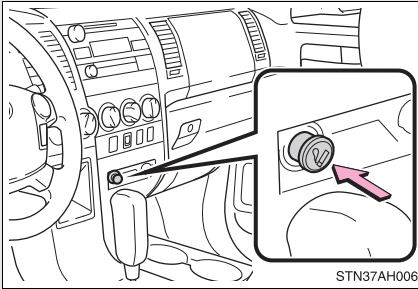

Push the cigarette lighter in.

The cigarette lighter will pop out when it is ready for use.

▶ Front bench type seat

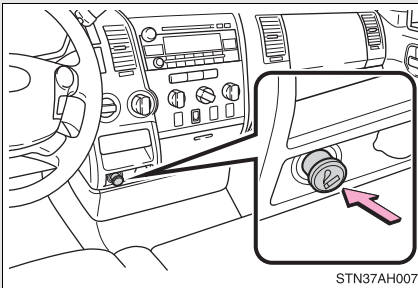

Push the cigarette lighter in.

The cigarette lighter will pop out when it is ready for use.

■ The cigarette lighter can be used when

The engine switch is in the ACC or ON position.

⚠ CAUTION

■ To avoid burns or fires

- Do not touch the metal parts of the cigarette lighter.
- Do not hold the cigarette lighter down. It could overheat and cause a fire.
- Do not insert anything other than the cigarette lighter into the outlet.

3-8. Other interior features

Power outlets (12V DC)

The power outlet can be used for accessories that run on less than 10 A.

► Type A (Instrument panel)

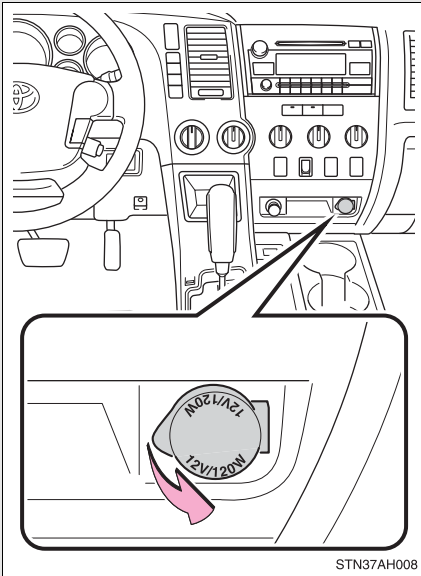

► Type B (Instrument panel)

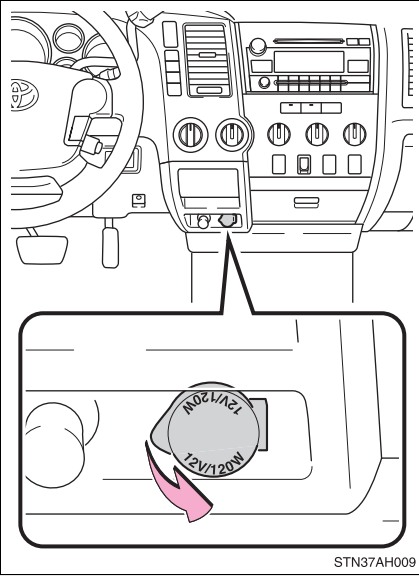

► Type C (Back of the front center seatback)

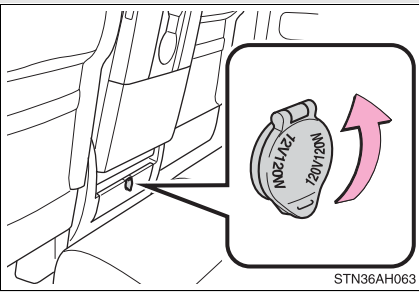

► Type D (Inside of the console box)

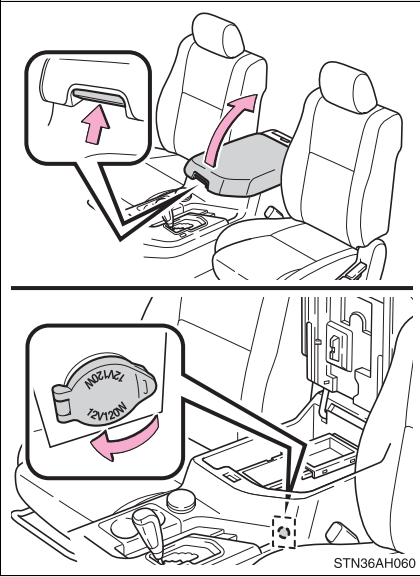

► Type E (Back of the console box)

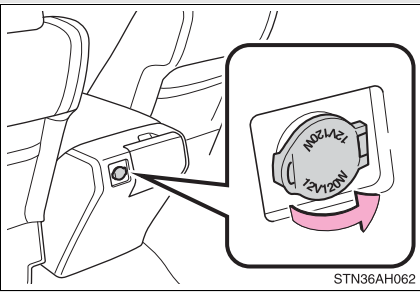

▶ Type F (Back of the front center seatback)

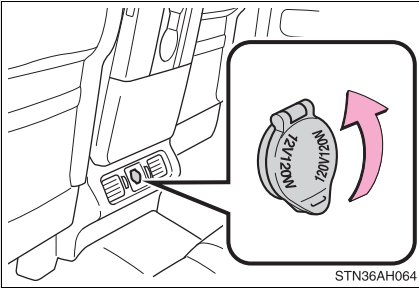

▶ Type G (Back of the console box)

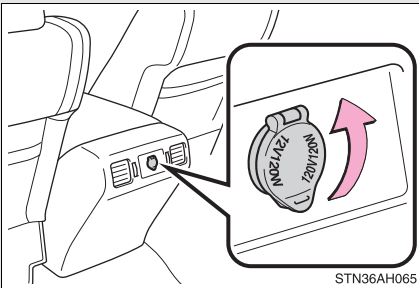

■ **The power outlet can be used when**

The engine switch is in the ACC or ON position.

■ **Depending on operating time and current consumption**

The power outlets may not be used due to the electrical component protection function. Please start engine and use the power outlets again after turn off the engine switch in this case.



NOTICE

■ **To avoid damaging the power outlet**

Close the power outlet lid when the power outlet is not in use.

Foreign objects or liquids that enter the power outlet may cause a short circuit.

■ **To prevent the fuse from being blown**

Do not use an accessory that uses more than 12 V/10 A.

■ **To prevent the battery from being discharged**

Do not use the power outlet longer than necessary when the engine is stopped.

3-8. Other interior features

Power outlets (115V AC)*

The power outlet can be used for accessories that use less than 100W.

► Front separated type seats

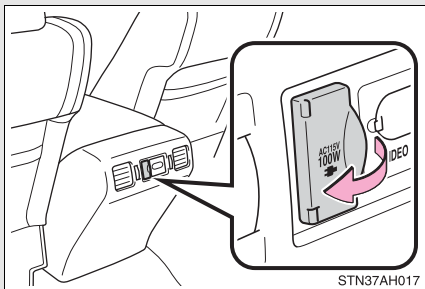

Power outlet socket

► Front bench type seat

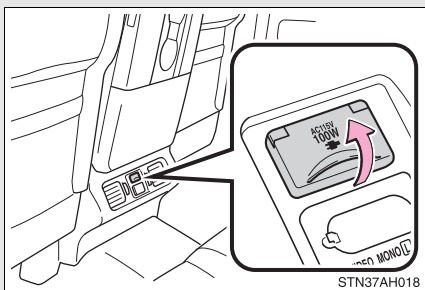

Power outlet socket

- The power outlet can be used when
The engine switch is in the ON position.

*: If equipped

 CAUTION

■ **Using a power outlet**

Observe the following precautions to reduce the risk of injury.

- Use of the power outlet when it is wet with drinking water or snow may result in electrical shocks and is extremely dangerous. The power outlet must be thoroughly dried before use.
- Do not allow children to use or play with the power outlet.
- Be careful not to get any part of your body caught in the power outlet lid.
- When using electrical appliances, strictly follow any cautions and notices written on their labels and in the manufacturers' instruction manuals.
- Do not modify, disassemble or repair the power outlet or its inverter, in any way. Doing so may result in unexpected malfunctions or accidents, which could cause serious damage or injuries. Contact a Toyota dealer for any necessary repairs.

■ **To prevent injuries and accidents, securely fix all electric appliances before use and do not use any appliances that may do any of the following.**

- Distract the driver while driving, or hamper safe driving.
- Result in a fire or burn injuries due to the appliance rolling, falling or overheating while driving.
- Emit steam, while the windows of the cabin are closed.

■ **To prevent unexpected accidents, such as electric shocks, do not perform any of the following.**

- Using the power outlet for electric heaters while sleeping.
- Contaminating the power outlet with liquid substances or mud.
- Handling electrical appliance plugs at the power outlet with wet hands or feet.
- Inserting foreign objects into the power outlet.
- Using malfunctioning electric appliances.
- Inserting inappropriate or badly fitting plugs into the power outlet.

 NOTICE

■ **To avoid damaging the power outlet and the plug**

- Close the power outlet lid when not in use.
- Foreign objects or liquids that enter the power outlet may cause a short circuit.
- Do not use plug adaptors to connect too many plugs to the power outlet.
- After inserting a plug, gently close the power outlet lid.

■ **To prevent the fuse from being blown**

Do not use a 115V AC appliance that requires more than 100 W.

If a 115V AC appliance that consumes more than 100 W is used, the protection circuit will cut the power supply.

■ **Appliances that may not operate properly**

The following 115V AC appliances may not operate even if their power consumption is under 100 W.

- Appliances with high initial peak wattage
- Measuring devices that process precise data
- Other appliances that require an extremely stable power supply

■ **To prevent the battery from being discharged**

Turn off all the vehicle's electronic equipment and accessories, such as the headlights and air conditioning, when electrical appliances that consume in excess of 100W are used continuously for long periods of time.

■ **To prevent any damage caused by heat**

- Do not use any electrical appliances that give off intense heat such as toasters, in any locations including the internal or external trim, seats and deck.
- Do not use any electrical appliances, which are easily affected by vibration or heat, inside the vehicle.
Vibration while driving, or the heat of the sun while parking, may result in damage to those electrical appliances.

■ **If any electrical appliances are to be used while driving**

Securely fasten both the appliances and their cables to prevent them from falling or getting caught any of the power train components.

 NOTICE

■ **If the power outlet is loose when an electrical appliance plug is connected**

Replace the outlet.

Contact a Toyota dealer for any necessary replacements.

■ **If the power outlet gets dirty**

Turn the main switch off and use a soft, clean cloth to wipe it gently.

Do not use any cleansing materials, such as organic solvents, wax, or compound cleaners, as these may damage the power outlet or cause it to malfunction.

Seat heaters*

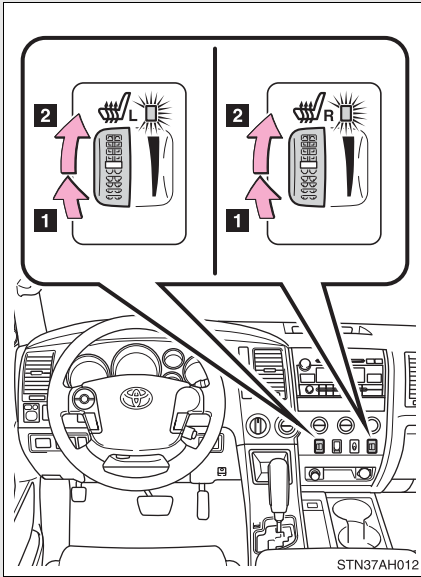

1 On

The indicator comes on.

2 Adjusts the seat temperature.

The further you turn the dial upward, the warmer the seat becomes.

■ The seat heaters can be used when

The engine switch is in the ON position.

■ When not in use

Turn the dial fully downward. The indicator turns off.

 CAUTION

■ **Burns**

- Use caution when seating the following persons in a seat with the seat heater on to avoid the possibility of burns:
 - Babies, small children, the elderly, the sick and the disabled
 - Persons with sensitive skin
 - Persons who are fatigued
 - Persons who have taken alcohol or drugs that induce sleep (sleeping drugs, cold remedies, etc.)
- Do not cover the seat with anything when using the seat heater. Using the seat heater with a blanket or cushion increases the temperature of the seat and may lead to overheating.

 NOTICE

■ **To prevent seat heater damage**

Do not put unevenly weighted objects on the seat and do not stick sharp objects (needles, nails, etc.) into the seat.

■ **To prevent battery discharge**

Turn the switches off when the engine is not running.

Seat heaters and ventilators*

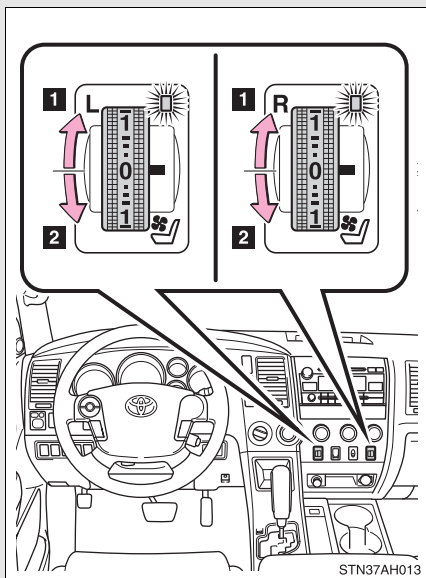

1 Blows air from the seats

The indicator comes on. The higher the number, the stronger the airflow becomes.

2 Heats the seats

The indicator comes on. The higher the number, the warmer the seats become.

■ The seat heaters can be used when

The engine switch is in the ON position.

■ When not in use

Set the dial to 0. The indicator turns off.

 CAUTION

■ **Burns**

- Use caution when seating the following persons in a seat with the seat heater on to avoid the possibility of burns:
 - Babies, small children, the elderly, the sick and the disabled
 - Persons with sensitive skin
 - Persons who are fatigued
 - Persons who have taken alcohol or drugs that induce sleep (sleeping drugs, cold remedies, etc.)
- Do not cover the seat with anything when using the seat heater. Using the seat heater with a blanket or cushion increases the temperature of the seat and may lead to overheating.

 NOTICE

■ **To prevent seat heater damage**

Do not put unevenly weighted objects on the seat and do not stick sharp objects (needles, nails, etc.) into the seat.

■ **To prevent battery discharge**

Turn the switches off when the engine is not running.

Armrest (CrewMax models only)

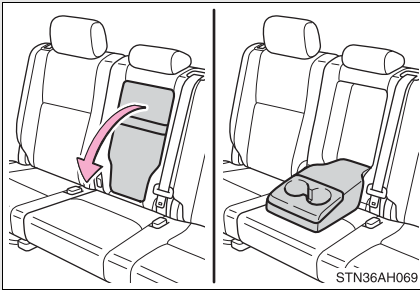

Pull the armrest down for use.



NOTICE

■ **To prevent damage to the armrest**

- Do not place too much strain on the armrest.
- Do not sit on the armrest.

Seatback table*

Front passenger's seatback can be used as a temporary table only when the vehicle is stopped.

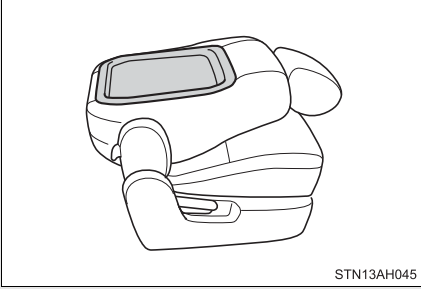

Fold down the front passenger's seat to use the seatback table. (→P. 63)

CAUTION

■ Caution while driving

Observe the following precautions to avoid death or serious injury.

- Do not set up the seatback table.
- Do not sit on or place anything on the seatback table.

NOTICE

■ To prevent damage to the seatback table

Do not put heavy loads on the table.

*: If equipped

Floor mat

Use only floor mats designed specifically for vehicles of the same model and model year as your vehicle. Fix them securely in place onto the carpet.

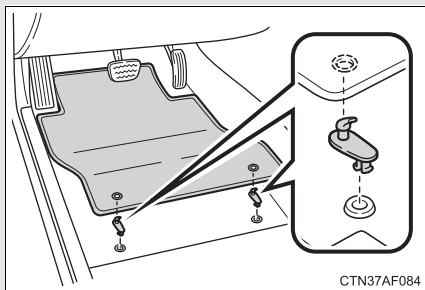

Fix the floor mat in place using the retaining hooks (clips) provided.

For details, refer to the floor mat retention clip installation instructions supplied with the clips.

⚠ CAUTION

Observe the following precautions.

Failure to do so may cause the driver's floor mat to slip, possibly interfering with the pedals while driving. An unexpectedly high speed may result or it may become difficult to stop the vehicle, leading to a serious accident.

■ When installing the driver's floor mat

- Do not use floor mats designed for other models or different model year vehicles, even if they are Toyota Genuine floor mats.
- Only use floor mats designed for the driver's seat.
- Always install the floor mat securely using the retaining hooks (clips) provided.
- Do not use two or more floor mats on top of each other.
- Do not place the floor mat bottom-side up or upside-down.

■ Before driving

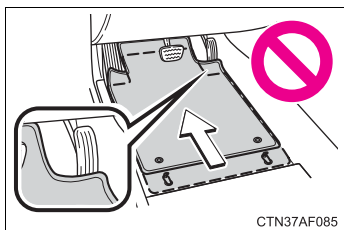

- Check that the floor mat is securely fixed in the right place with all the provided retaining hooks (clips). Be especially careful to perform this check after cleaning the floor.
- With the engine stopped and the shift lever in P, fully depress each pedal to the floor to make sure it does not interfere with the floor mat.

Luggage compartment features

■ Deck hooks

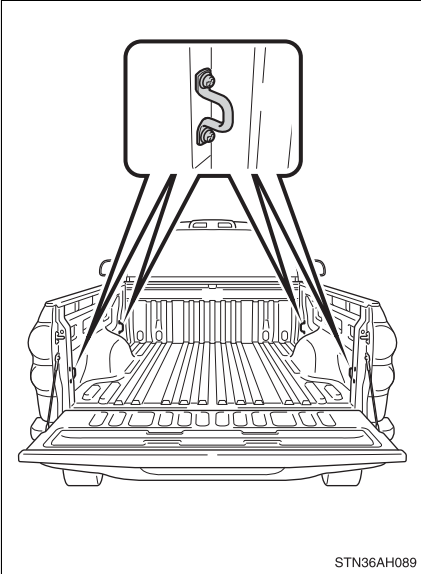

Deck hooks are provided for securing loose items.

■ Cargo net hooks (CrewMax models only)

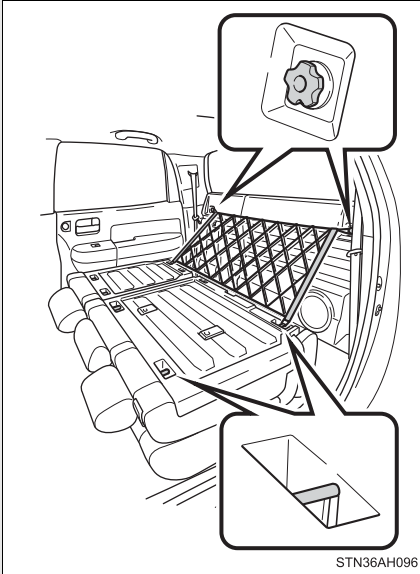

To hang the cargo net, use the cargo net hooks.

The cargo net itself is not included as original equipment.

■ Shopping bag hooks (CrewMax models only)

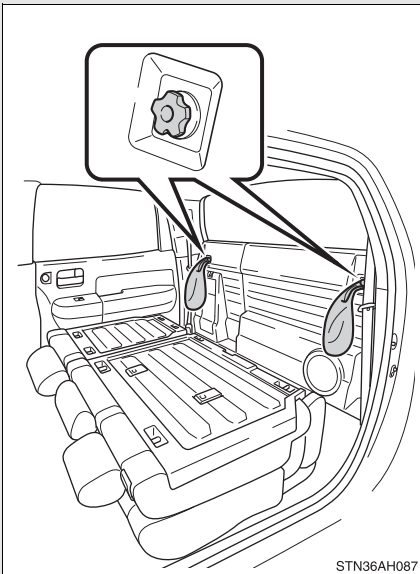

To hang shopping bags, use the shopping bag hooks.



NOTICE

■ **To prevent damage to the cargo net hooks and shopping bag hooks**

- Avoid hanging heavy loads on the cargo net hooks or shopping bag hooks.
- Avoid hanging things other than the cargo net when using the shopping bag hooks as cargo net hooks.

3-8. Other interior features

Garage door opener*

The garage door opener can be programmed to operate garage doors, gates, entry doors, door locks, home lighting systems, security systems, and other devices.

The garage door opener (HomeLink® Universal Transceiver) is manufactured under license from HomeLink®.

Programming the HomeLink® (for U.S.A. owners)

The HomeLink® compatible transceiver in your vehicle has 3 buttons which can be programmed to operate 3 different devices. Refer to the programming method below appropriate for the device.

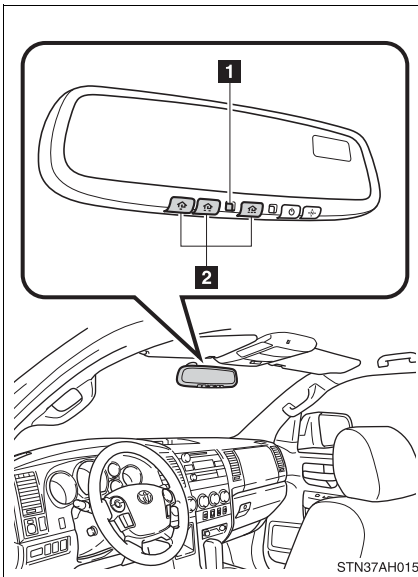

- 1** Indicator
- 2** Buttons

*: If equipped

■ Programming the HomeLink®

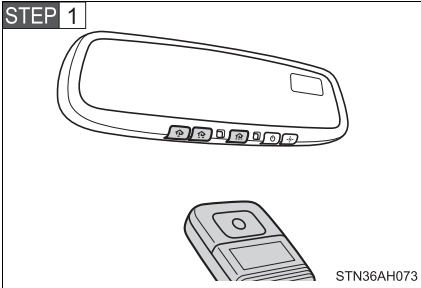

Point the remote control transmitter for the device 1 to 3 in. (25 to 75 mm) from the HomeLink® control buttons.

Keep the indicator on the HomeLink® in view while programming.

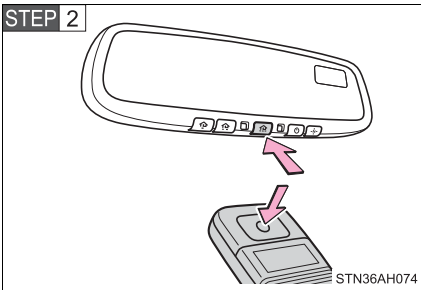

Press and hold down one of the buttons on the HomeLink® and the button on the transmitter. When the indicator on the HomeLink® changes from a slow to a rapid flash after 20 seconds, you can release both buttons.

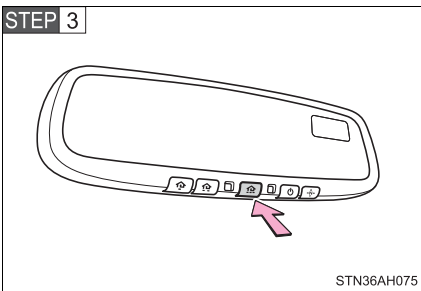

Test the operation of the HomeLink® by pressing the newly programmed button.

If programming a garage door opener, check to see if the garage door opens and closes. If the garage door does not operate, see if your garage transmitter is of the Rolling Code type. Press and hold the programmed HomeLink® button. The garage door has the rolling code feature if the indicator (on the HomeLink®) flashes rapidly for 2 seconds and then remains lit. If your transmitter is the Rolling Code type, proceed to the heading “Programming a rolling code system”.

STEP 4 Repeat the steps above to program another device for each of the remaining HomeLink® buttons.

■ Programming a Rolling Code system (for U.S.A. owners)

If your device is Rolling Code equipped, follow the steps under the heading “Programming the HomeLink®” before proceeding with the steps listed below.

STEP 1 Locate the training button on the ceiling mounted garage door opener motor. The exact location and color of the button may vary by brand of garage door opener.

Refer to the operation manual supplied with the garage door opener for the location of the training button.

STEP 2 Press the training button.

Following this step, you have 30 seconds in which to initiate step 3 below.

STEP 3 Press and release the vehicle’s programmed HomeLink® button twice. The garage door may open.

If the garage door opens, the programming process is complete. If the door does not open, press and release the button a third time. This third press and release will complete the programming process by opening the garage door.

The ceiling mounted garage door opener motor should now recognize the HomeLink® transceiver and operate the garage door.

STEP 4 Repeat the steps above to program another rolling code system for any of the remaining HomeLink® buttons.

■ Programming an entry gate (for U.S.A. owners)/Programming all devices in the Canadian market

STEP 1 Place your transmitter 1 to 3 in. (25 to 75 mm) away from the surface of the HomeLink®.

Keep the indicator on the HomeLink® in view while programming.

STEP 2 Press and hold the selected HomeLink® button.

STEP 3 Repeatedly press and release (cycle) the device’s remote control button for two seconds each until step 4 is complete.

STEP 4 When the indicator on the HomeLink[®] compatible transceiver start to flashing rapidly, release the buttons.

STEP 5 Test the operation of the HomeLink[®] by pressing the newly programmed button. Check to see if the gate/device operates correctly.

STEP 6 Repeat the steps above to program another device for each of the remaining HomeLink[®] buttons.

■ Programming other devices

To program other devices such as home security systems, home door locks or lighting, contact your authorized Toyota dealer for assistance.

■ Reprogramming a button

The individual HomeLink[®] buttons cannot be erased but can be reprogrammed. To reprogram a button, follow the programming instructions.

Operating the HomeLink[®]

Press the appropriate HomeLink[®] button. The HomeLink[®] indicator on the HomeLink[®] transceiver should turn on.

The HomeLink[®] continues to send a signal for a maximum of 20 seconds if the button is held in.

Erasing the entire HomeLink[®] memory (all three programs)

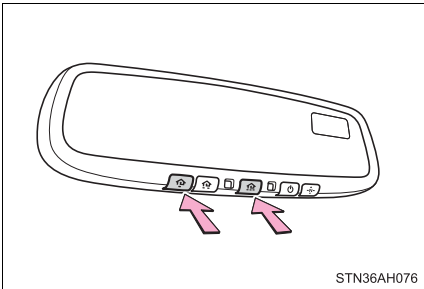

Press and hold down the 2 outside buttons for 20 seconds until the indicator flashes.

If you sell your vehicle, be sure to erase the programs stored in the HomeLink[®] memory.

■ Before programming

- Install a new battery in the remote control transmitter.
- The battery side of the remote control transmitter must be pointed away from the HomeLink®.

■ Certification for the garage door opener

This device complies with Part 15 of the FCC Rules and with RSS-210 of the IC Rules.

Operation is subject to the following two conditions: (1) This device may not cause harmful interference, and (2) this device must accept any interference received, including interference that may cause undesired operation.

WARNING: This transmitter has been tested and complies with FCC and IC rules. Changes or modifications not expressly approved by the party responsible for compliance could void the user's authority to operate the device.

⚠ CAUTION**■ When programming a garage door or other remote control device**

The garage door may operate, so ensure that people and objects are out of danger to prevent potential harm.

■ Conforming to federal safety standards

Do not use the HomeLink® Compatible Transceiver with any garage door opener or device that lacks safety stop and reverse features as required by federal safety standards.

This includes any garage door that cannot detect an obstruction object. A door or device without these features increases the risk of death or serious injury.

Compass*

The compass on the inside rear view mirror indicates the direction in which the vehicle is heading.

■ Operation

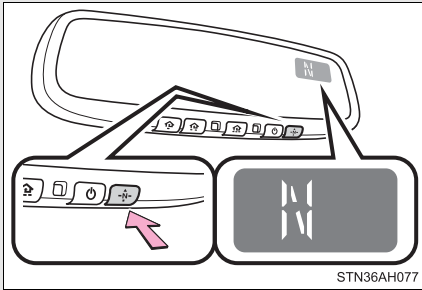

To turn the compass on or off, press the switch.

■ Displays and directions

Display	Direction
N	North
NE	Northeast
E	East
SE	Southeast
S	South
SW	Southwest
W	West
NW	Northwest

*: If equipped

Calibrating the compass

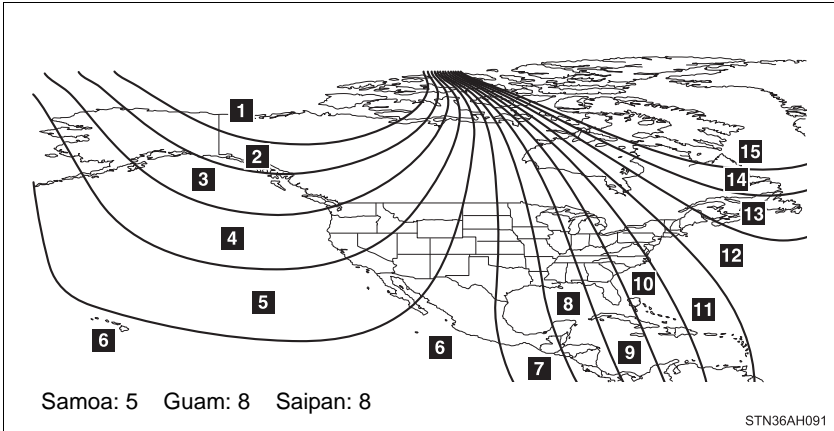

The direction display deviates from the true direction determined by the earth's magnetic field. The amount of deviation varies according to the geographic position of the vehicle.

If you cross over a map boundary shown in illustration, the compass will deviate.

To obtain higher precision or accurate calibration, refer to the following.

■ Deviation calibration

STEP 1 Stop the vehicle where it is safe to drive in a circle.

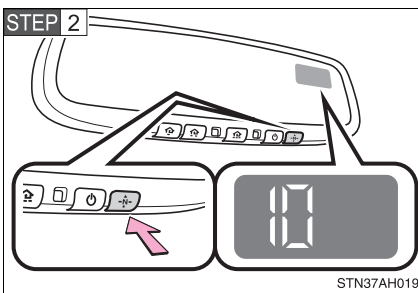

Press the switch until a number (1 to 15) appears on the compass display.

STEP 3 Press the switch, and referring to the map above, select the number of the zone where you are.

If the direction is displayed several seconds after adjustment, the calibration is complete.

■ Circling calibration

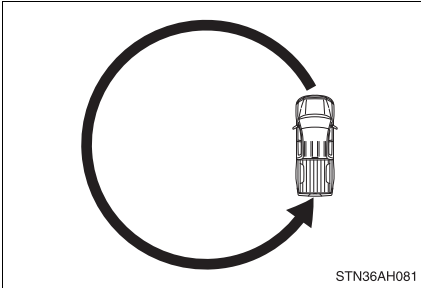

When “C” appears on the display, drive the vehicle at 5 mph (8 km/h) or less in a circle until a direction is displayed.

If there is not enough space to drive in a circle, drive around the block until the direction is displayed.

■ Conditions unfavorable to correct operation

The compass may not show the correct direction in the following conditions:

- The vehicle is stopped immediately after turning.
- The vehicle is on an inclined surface.
- The vehicle is in a place where the earth’s magnetic field is subject to interference by artificial magnetic fields (underground car park/parking lot, under a steel tower, between buildings, roof car park/parking lot, near an intersection, near a large vehicle, etc.).
- The vehicle has become magnetized.
(There is a magnet or metal object near the inside rear view mirror.)
- The battery has been disconnected.
- A door is open.

⚠ CAUTION

■ While driving the vehicle

Do not adjust the display. Be sure to adjust the display only when the vehicle is stopped.

■ When doing the circling calibration

Be sure to secure a wide space, and watch out for people and vehicles in the neighborhood. Do not violate any local traffic rules while performing circling calibration.

**NOTICE****■ To avoid the compass malfunctions**

Do not place magnets or any metal objects near the inside rear view mirror. Doing this may cause a malfunction of the compass sensor.

■ To ensure normal operation of the compass

- Do not perform circling calibration of the compass in a place where the earth's magnetic field is subject to interference by artificial magnetic fields.
- During calibration, do not operate electric systems (moon roof, power windows, etc.) as they may interfere with the calibration.

4-1. Maintenance and care

Cleaning and protecting
the vehicle exterior..... 512

Cleaning and protecting
the vehicle interior..... 514

4-2. Maintenance

Maintenance
requirements 517

General maintenance..... 519

Emission inspection
and maintenance (I/M)
programs..... 522

4-3. Do-it-yourself maintenance

Do-it-yourself service
precautions 523

Hood 527

Engine compartment..... 528

Tires 542

Tire inflation pressure 549

Wheels 553

Air conditioning filter..... 555

Wireless remote control
battery 558

Checking and replacing
fuses 560

Light bulbs..... 571

Cleaning and protecting the vehicle exterior

Perform the following to protect the vehicle and maintain it in prime condition.

- Working from top to bottom, liberally apply water to the vehicle body, wheel wells and underside of the vehicle to remove any dirt and dust.
Wash the vehicle body using a sponge or soft cloth, such as a chamois.
- For hard-to-remove marks, use car wash soap and rinse thoroughly with water.
- Wipe away any water.
- Wax the vehicle when the waterproof coating deteriorates.

If water does not bead on a clean surface, apply wax when the vehicle body is cool.

■ Automatic car washes

- Before washing the vehicle, do the following.
 - Fold the mirrors back.
 - Remove the antenna.
- Brushes used in automatic car washes may scratch the vehicle surface and harm your vehicle's paint.

■ High pressure car washes

Do not allow the nozzles of the car wash to come within close proximity of the windows. Before entering an automatic car wash, check that the fuel filler door on your vehicle is closed properly.

■ Aluminum wheels (if equipped)

- Remove any dirt immediately by using a neutral detergent. Do not use hard brushes or abrasive cleaners. Do not use strong or harsh chemical cleaners. Use the same mild detergent and wax as used on the paint.
- Do not use detergent on the wheels when they are hot, for example after driving for long distance in the hot weather.
- Wash detergent from the wheels immediately after use.

■ Bumpers and side moldings

Do not scrub with abrasive cleaners.

CAUTION

■ Caution about the exhaust pipe

Exhaust gasses cause the exhaust pipe to become quite hot.

When washing the vehicle, be careful not to touch the pipe until it has cooled sufficiently, as touching a hot exhaust pipe can cause burns.

NOTICE

■ To prevent paint deterioration and corrosion on the body and components (aluminum wheels etc.)

● Wash the vehicle immediately in the following cases:

- After driving near the sea coast
- After driving on salted roads
- If you see coal tar or tree sap on the paint surface
- If you see dead insects or bird droppings on the paint
- After driving in an area contaminated with soot, oily smoke, mine dust, iron powder or chemical substances
- If the vehicle becomes heavily soiled in dust or mud
- If liquids such as benzene and gasoline are spilled on the paint surface

● If the paint is chipped or scratched, have it repaired immediately.

● To prevent the wheels from corroding, remove any dirt and store in a place with low humidity when storing the wheels.

■ Cleaning the exterior lights

● Wash carefully. Do not use organic substances or scrub with a hard brush. This may damage the surfaces of the lights.

● Do not apply wax on the surfaces of the lights. Wax may cause damage to the lenses.

■ Antenna installation and removal precautions

● Before driving, ensure that the antenna is installed.

● When the antenna is removed, such as before entering an automatic car wash, make sure to store it in a suitable place so as not to lose it. Also, before driving, make sure to reinstall the antenna in its original position.

Cleaning and protecting the vehicle interior

The following procedures will help protect your vehicle's interior and keep it in top condition:

■ **Protecting the vehicle interior**

Remove dirt and dust using a vacuum cleaner. Wipe dirty surfaces with a cloth dampened with lukewarm water.

■ **Cleaning the leather areas**

- Remove dirt and dust using a vacuum cleaner.
- Wipe any excess dirt and dust with a soft cloth dampened with diluted detergent.

Use a diluted water solution of approximately 5% neutral wool detergent.

- Wring out any excess water from the cloth and thoroughly wipe off all remaining traces of detergent.
- Wipe the surface with a dry, soft cloth to remove any remaining moisture. Allow the leather to dry in a shaded and ventilated area.

■ **Synthetic leather areas**

- Remove loose dirt using a vacuum cleaner.
- Apply a mild soap solution to the synthetic leather using a sponge or soft cloth.
- Allow the solution to soak in for a few minutes. Remove the dirt and wipe off the solution with a clean, damp cloth.

■ Caring for leather areas

Toyota recommends cleaning the interior of the vehicle at least twice a year to maintain the quality of the vehicle's interior.

■ Shampooing the carpets

There are several commercial foaming-type cleaners available. Use a sponge or brush to apply the foam. Rub in overlapping circles. Do not apply water. Excellent results are obtained when keeping the carpet as dry as possible.

■ Seat belts

Clean with mild soap and lukewarm water using a cloth or sponge. Also check the belts periodically for excessive wear, fraying or cuts.

CAUTION

■ Water in the vehicle

- Do not splash or spill liquid in the vehicle.
Doing so may cause the electrical components etc. to malfunction or catch fire.
- Do not get any of the SRS components or wiring in the vehicle interior wet. (→P. 121)
Electrical malfunction may cause the airbags to deploy or not function properly, resulting in death or severe injury.

■ Cleaning the interior (especially instrument panel)

Do not use polish wax or polish cleaner. The instrument panel may reflect off the windshield, obstructing the driver's view and leading to an accident, resulting in death or serious injury.

 NOTICE

■ **Cleaning detergents**

- Do not use organic substances such as benzene or gasoline, acidic or alkaline solutions, dye, bleach or other detergent. Doing so may discolor the vehicle interior or cause streaks or damage to painted surfaces.
- Do not use polish wax or polish cleaner. The instrument panel's or other interior part's painted surface may be damaged.

■ **Preventing damage to leather surfaces**

Observe the following precautions to avoid damage to and deterioration of leather surfaces.

- Remove any dust or dirt on leather surfaces immediately.
- Do not expose the vehicle to direct sunlight for extended periods of time. Park the vehicle in the shade, especially during summer.
- Do not place items made of vinyl or plastic, or that contain wax on the upholstery, as they may stick to the leather surface if the vehicle interior heats up significantly.

■ **Water on the floor**

Do not wash the vehicle floor with water.

Vehicle systems such as the audio system may be damaged if water comes into contact with electrical components under the floor of the vehicle, and may also cause the body to rust.

■ **Cleaning the inside of the back window (vehicles with the back window defogger)**

- Do not use glass cleaner to clean the back window, as this may cause damage to the back window defogger heater wires. Use a cloth dampened with lukewarm water to gently wipe the window clean. Wipe the window in strokes running parallel to the heater wires.
- Be careful not to scratch or damage the heater wires.

Maintenance requirements

To ensure safe and economical driving, day-to-day care and regular maintenance are essential. It is the owner's responsibility to perform regular checks. Toyota recommends the following maintenance.

■ General maintenance

Should be performed on a daily basis. This can be done by yourself or by a Toyota dealer.

■ Scheduled maintenance

Should be performed at specified intervals according to the maintenance schedule.

For details about maintenance items and schedules, refer to the "Scheduled Maintenance Guide" or "Owner's Manual Supplement".

■ Do-it-yourself maintenance

You can perform some maintenance procedures yourself. Please be aware that do-it-yourself maintenance may affect warranty coverage.

The use of Toyota Repair Manuals is recommended.

For details about warranty coverage, see the separate "Owner's Warranty Information Booklet", "Owner's Manual Supplement".

■ Repair and replacement

It is recommended that genuine Toyota parts be used for repair to ensure performance of each system. If non-Toyota parts are used in replacement or if a repair shop other than Toyota dealer performs repairs, confirm the warranty coverage.

Flex-fuel vehicles: Flex-fuel vehicles use special parts made exclusively for flex-fuel vehicles. When servicing or repairing your vehicles, use genuine Toyota parts made exclusively for your flex-fuel vehicle.

■ **Allow inspection and repairs to be performed by a Toyota dealer**

- Toyota technicians are well-trained specialists and are kept up to date with the latest service information. They are well informed about the operations of all systems on your vehicle.
- Keep a copy of the repair order. It proves that the maintenance that has been performed is under warranty coverage. If any problem should arise while your vehicle is under warranty, your Toyota dealer will promptly take care of it.

 **CAUTION**

■ **Warning in handling of battery**

- Engine exhaust, some of its constituents, and a wide variety of automobile components contain or emit chemicals known to the State of California to cause cancer and birth defects and other reproductive harm. Work in a well ventilated area.
- Oils, fuels and fluids contained in vehicles as well as waste produced by component wear contain or emit chemicals known to the State of California to cause cancer and birth defects or other reproductive harm. Avoid exposure and wash any affected area immediately.
- Battery posts, terminals and related accessories contain lead and lead compounds which are known to cause brain damage. Wash your hands after handling. (→P. 538)

General maintenance

Listed below are the general maintenance items that should be performed at the intervals specified in the “Scheduled Maintenance Guide” or “Owner’s Manual Supplement”. It is recommended that any problem you notice should be brought to the attention of your Toyota dealer or qualified service shop for advice.

Engine compartment

Items	Check points
Battery	Maintenance-free. (→P. 538)
Brake fluid	At the correct level? (→P. 535)
Engine coolant	At the correct level? (→P. 534)
Engine oil	At the correct level? (→P. 530)
Exhaust system	No fumes or strange sounds?
Power steering fluid	At the correct level? (→P. 537)
Radiator/condenser/hoses	Not blocked with foreign matter? (→P. 535)
Washer fluid	At the correct level? (→P. 540)

Vehicle interior

Items	Check points
Accelerator pedal	<ul style="list-style-type: none"> • Moves smoothly (without uneven pedal effort or catching)?
Automatic transmission “Park” mechanism	<ul style="list-style-type: none"> • Can the vehicle be held securely on an incline with the shift lever in P?
Brake pedal	<ul style="list-style-type: none"> • Moves smoothly? • Does it have appropriate clearance and correct amount of free play?
Brakes	<ul style="list-style-type: none"> • Not pull to one side when applied? • Loss of brake effectiveness? • Spongy feeling brake pedal? • Pedal almost touches floor?
Head restraints	<ul style="list-style-type: none"> • Move smoothly and lock securely?
Indicators/buzzers	<ul style="list-style-type: none"> • Function properly?
Lights	<ul style="list-style-type: none"> • Do all the lights come on? • Headlights aimed correctly?
Parking brake	<ul style="list-style-type: none"> • Moves smoothly? • Can hold the vehicle securely on an incline?
Seat belts	<ul style="list-style-type: none"> • Does the seat belt system operate smoothly? • Are the belts undamaged?
Seats	<ul style="list-style-type: none"> • Do the seat controls operate properly?
Steering wheel	<ul style="list-style-type: none"> • Moves smoothly? • Has correct free play? • No strange noises?

Vehicle exterior

Items	Check points
Doors	<ul style="list-style-type: none"> • Operate smoothly?
Engine hood	<ul style="list-style-type: none"> • The lock system works properly?
Fluid leaks	<ul style="list-style-type: none"> • Is there any leakage after parking?
Tire	<ul style="list-style-type: none"> • Inflation pressure is correct? • Tire surfaces not worn or damaged? • Tires rotated according to the maintenance schedule? • Wheel nuts are not loose?

CAUTION

■ If the engine is running

Turn the engine off and ensure that there is adequate ventilation before performing maintenance checks.

Some states have vehicle emission inspection programs which include OBD (On Board Diagnostics) checks. The OBD system monitors the operation of the emission control system.

■ **If the malfunction indicator lamp comes on**

The OBD system determines that a problem exists somewhere in the emission control system. Your vehicle may not pass the I/M test and may need to be repaired. Contact your Toyota dealer to service the vehicle.

■ **Your vehicle may not pass the I/M test:**

- When the battery is disconnected or discharged

Readiness codes that are set during ordinary driving are erased.

Also, depending on your driving habits, the readiness codes may not be completely set.

- When the fuel tank cap is loose

The malfunction indicator lamp comes on as a temporary malfunction and your vehicle may not pass the I/M test.

■ **When the malfunction indicator lamp goes off after several driving trips**

The error code in the OBD system will not be cleared unless the vehicle is driven 40 or more times.

■ **If your vehicle does not pass the I/M test**

Contact your Toyota dealer to prepare the vehicle for re-testing.

Do-it-yourself service precautions

If you perform maintenance yourself, be sure to follow the correct procedures as given in these sections.

Items	Parts and tools
Battery condition (→P. 538)	<ul style="list-style-type: none"> • Warm water • Baking soda • Grease • Conventional wrench (for terminal clamp bolts)
Brake fluid level (→P. 535)	<ul style="list-style-type: none"> • FMVSS No.116 DOT 3 or SAE J1703 brake fluid • Rag or paper towel
Engine coolant level (→P. 534)	<ul style="list-style-type: none"> • “Toyota Super Long Life Coolant” or similar high quality ethylene glycol based non-silicate, non-amine, non-nitrite and non-borate coolant with long-life hybrid organic acid technology. <p>U.S.A.:</p> <p>“Toyota Super Long Life Coolant” is pre-mixed with 50% coolant and 50% deionized water.</p> <p>Canada:</p> <p>“Toyota Super Long Life Coolant” is pre-mixed with 55% coolant and 45% deionized water.</p>
Engine oil level (→P. 530)	<ul style="list-style-type: none"> • Toyota Genuine Motor Oil or equivalent • Rag or paper towel • Funnel (used only for adding oil)
Fuses (→P. 560)	<ul style="list-style-type: none"> • Fuse with same amperage rating as original

Items	Parts and tools
Light bulbs (→P. 571)	<ul style="list-style-type: none"> • Bulb with same number and wattage rating as original • Phillips-head screwdriver • Flathead screwdriver
Power steering fluid level (→P. 537)	<ul style="list-style-type: none"> • Automatic transmission fluid DEXRON® II or III • Rag or paper towel
Radiator and condenser (→P. 535)	—
Tire inflation pressure (→P. 549)	<ul style="list-style-type: none"> • Tire pressure gauge • Compressed air source
Washer fluid (→P. 540)	<ul style="list-style-type: none"> • Water • Washer fluid containing antifreeze (for winter use)

 **CAUTION**

The engine compartment contains many mechanisms and fluids that may move suddenly, become hot, or become electrically energized. To avoid death or serious injury observe the following precautions.

■ When working on the engine compartment

- Keep hands, clothing, and tools away from the moving fan and engine drive belt.
- Be careful not to touch the engine, radiator, exhaust manifold, etc. right after driving as they may be hot. Oil and other fluids may also be hot.
- Do not leave anything that may burn easily, such as paper or rags, in the engine compartment.
- Do not smoke, cause sparks or expose an open flame to fuel or the battery. Fuel and battery fumes are flammable.
- Be extremely cautious when working on the battery. It contains poisonous and corrosive sulfuric acid.
- Take care because brake fluid can harm your hands or eyes and damage painted surfaces.
If fluid gets on your hands or in your eyes, flush the affected area with clean water immediately.
If you still experience discomfort, see a doctor.

■ When working near the cooling fan or radiator grille

Be sure the engine switch is off.

With the engine switch on, the cooling fan may automatically start to run if the air conditioning is on and/or the coolant temperature is high.

■ Safety glasses

Wear safety glasses to prevent flying or falling material, fluid spray, etc. from getting in the eyes.



NOTICE

■ If you remove the air cleaner

Driving with the air cleaner removed may cause excessive engine wear due to dirt in the air. Also a backfire could cause a fire in the engine compartment.

■ If the brake fluid level is low or high

It is normal for the brake fluid level to go down slightly as the brake pads wear or when the brake fluid level in the accumulator is high.

If the reservoir needs frequent refilling, it may indicate a serious problem.

4-3. Do-it-yourself maintenance

Hood

Release the lock from the inside of the vehicle to open the hood.

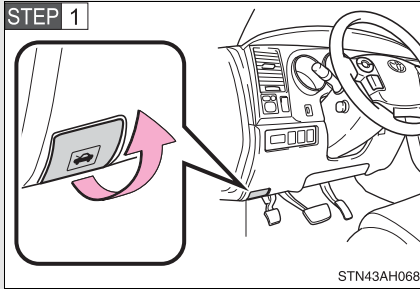

Pull the hood release lever.

The hood will pop up slightly.

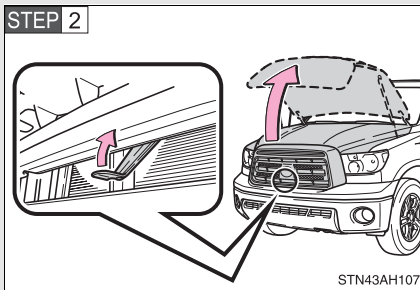

Pull up the hood catch lever and lift the hood.

⚠ CAUTION

■ Pre-driving check

Check that the hood is fully closed and locked.

If the hood is not locked properly, it may open while the vehicle is in motion and cause an accident, which may result in death or serious injury.

4-3. Do-it-yourself maintenance

Engine compartment

► 4.0 L V6 (1GR-FE) engine

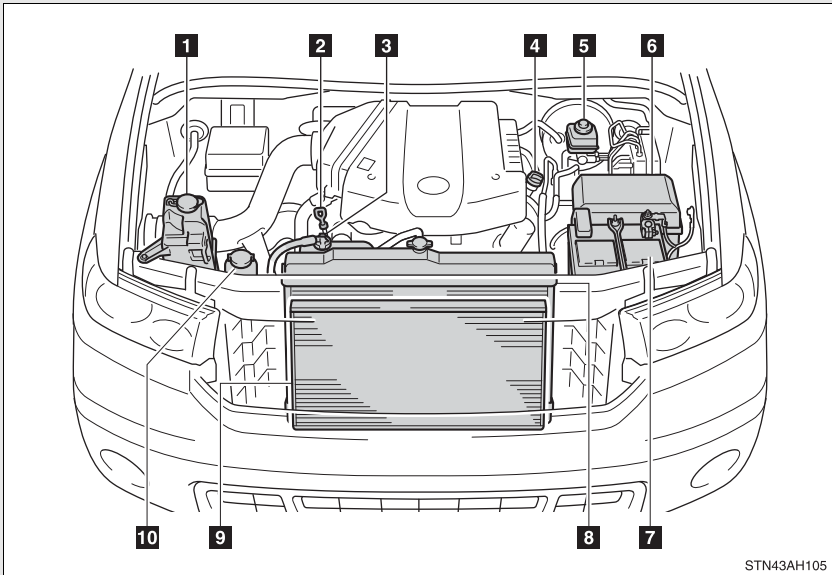

- | | |
|--|--|
| 1 Washer fluid tank (→P. 540) | 5 Brake fluid reservoir (→P. 535) |
| 2 Engine oil level dipstick (→P. 530) | 6 Fuse box (→P. 560) |
| 3 Engine coolant reservoir (→P. 534) | 7 Battery (→P. 538) |
| 4 Engine oil filler cap (→P. 531) | 8 Radiator (→P. 535) |
| | 9 Condenser (→P. 535) |
| | 10 Power steering fluid reservoir (→P. 537) |

► 4.6 L V8 (1UR-FE) and 5.7 L V8 (3UR-FE, 3UR-FBE) engines

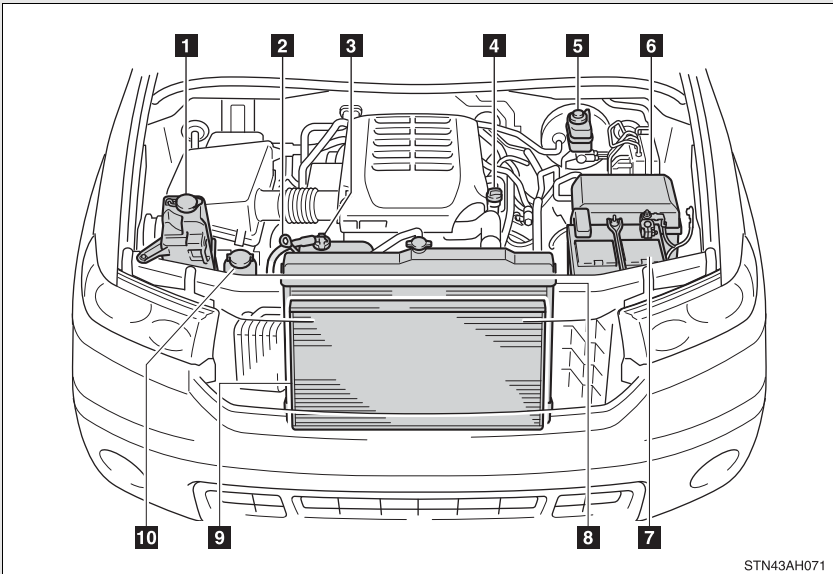

STN43AH071

- | | |
|--|--|
| 1 Washer fluid tank (→P. 540) | 5 Brake fluid reservoir (→P. 535) |
| 2 Engine oil level dipstick (→P. 530) | 6 Fuse box (→P. 560) |
| 3 Engine coolant reservoir (→P. 534) | 7 Battery (→P. 538) |
| 4 Engine oil filler cap (→P. 531) | 8 Radiator (→P. 535) |
| | 9 Condenser (→P. 535) |
| | 10 Power steering fluid reservoir (→P. 537) |

Engine oil

With the engine at operating temperature and turned off, check the oil level on the dipstick.

■ Checking the engine oil

STEP 1 Park the vehicle on level ground. After turning off the engine, wait more than 5 minutes for the oil to drain back into the bottom of the engine.

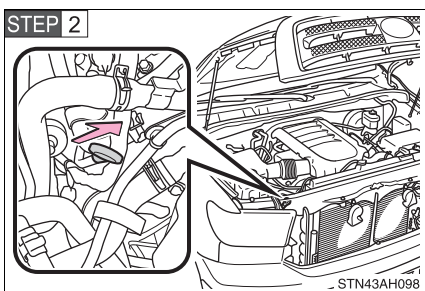

Hold a rag under the end and pull the dipstick out.

STEP 3 Wipe the dipstick clean.

STEP 4 Reinsert the dipstick fully.

STEP 5 Holding a rag under the end, pull the dipstick out and check the oil level.

STEP 6 Wipe the dipstick and reinsert it fully.

► 4.0 L V6 (1GR-FE) engine

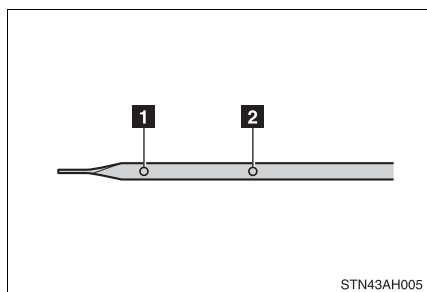

1 Low

2 Full

► 4.6 L V8 (1UR-FE) and 5.7 L V8 (3UR-FE, 3UR-FBE) engines

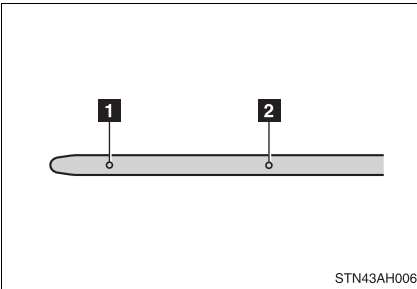

1 Low

2 Full

STN43AH006

■ Adding engine oil

► 4.0 L V6 (1GR-FE) engine

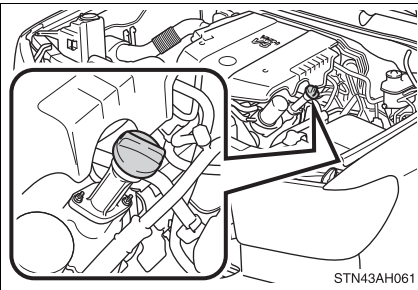

If the oil level is below or near the low level mark, add engine oil of the same type as already in the engine.

STN43AH061

► 4.6 L V8 (1UR-FE) and 5.7 L V8 (3UR-FE, 3UR-FBE) engines

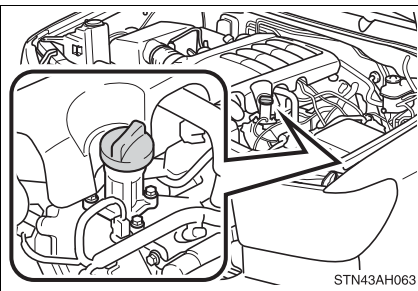

If the oil level is below or near the low level mark, add engine oil of the same type as already in the engine.

STN43AH063

Make sure to check the oil type and prepare the items needed before adding oil.

Engine oil selection	→P. 656
Items	Clean funnel

STEP 1 Remove the oil filler cap, turning it counterclockwise.

STEP 2 Add engine oil slowly.

STEP 3 Checking the dipstick.

STEP 4 Reinstall the filler cap, turning it clockwise.

The approximate quantity of oil needed to raise the level between low and full on the dipstick is indicated as follows:

1.6 qt. (1.5 L, 1.3 Imp. qt.)

■ Engine oil consumption

- The amount of engine oil consumed depends on the oil viscosity, the quality of the oil and the way the vehicle is driven.
- More oil is consumed under driving conditions such as high speeds and frequent acceleration and deceleration.
- A new engine consumes more oil.
- When judging the amount of oil consumption, keep in mind that the oil may have become diluted, making it difficult to judge the true level accurately.

■ After changing the engine oil (U.S.A. only)

The oil change system should be reset. Perform the following procedures:

STEP 1 Turn the engine switch off with the trip meter A reading shown.

STEP 2 While pressing the trip meter reset button (→P. 194, 196), turn the engine switch on.

▶ Without multi-information display

STEP 3 Continue to press and hold the button until the trip meter displays 000000.

▶ With multi-information display

STEP 3 Continue to press and hold the button until “MAINT REQD RESET MODE COMPLETE” appears on the multi-information display.

CAUTION

■ Used engine oil

- Used engine oil contains potentially harmful contaminants which may cause skin disorders such as inflammation or skin cancer, so care should be taken to avoid prolonged and repeated contact. To remove used engine oil from your skin, wash thoroughly with soap and water.
- Dispose of used oil and filters only in a safe and acceptable manner. Do not dispose of used oil and filters in household trash, in sewers or onto the ground. Call your Toyota dealer, service station or auto parts store for information concerning recycling or disposal.
- Do not leave used engine oil within the reach of children.

NOTICE

■ To prevent serious engine damage

Check the oil level on a regular basis.

■ When replacing the engine oil

- Be careful not to spill engine oil on the vehicle components.
- Avoid overfilling, as the engine could be damaged.
- Check the oil level on the dipstick every time you refill the vehicle.
- Be sure the engine oil filler cap is properly tightened.

Engine coolant

The coolant level is satisfactory if it is between the FULL and LOW lines on the reservoir when the engine is cold.

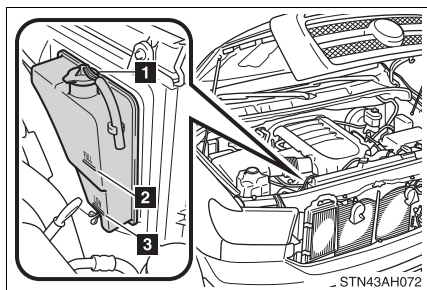

1 Reservoir cap

2 FULL

3 LOW

If the level is on or below the LOW line, add coolant up to the FULL line.

■ If the coolant level drops within a short time after replenishing

Visually check the radiator, hoses, reservoir cap, radiator cap, drain cock and water pump.

If you cannot find a leak, have your Toyota dealer pressure test the cap and check for leaks in the cooling system.

■ Coolant selection

Only use “Toyota Super Long Life Coolant” or similar high quality ethylene glycol based non-silicate, non-amine, non-nitrite and non-borate coolant with long-life hybrid organic acid technology.

U.S.A.: “Toyota Super Long Life Coolant” is a mixture of 50% coolant and 50% deionized water. (Enabled: -31°F [-35°C])

Canada: “Toyota Super Long Life Coolant” is a mixture of 55% coolant and 45% deionized water. (Enabled: -44°F [-42°C])

For more details about engine coolant, contact your Toyota dealer.

⚠ CAUTION

■ When the engine is hot

Do not remove the radiator cap.

The cooling system may be under pressure and may spray hot coolant if the cap is removed, causing burns or other injuries.

 NOTICE

■ **When adding engine coolant**

Coolant is neither plain water nor straight antifreeze. The correct mixture of water and antifreeze must be used to provide proper lubrication, corrosion protection and cooling. Be sure to read the antifreeze or coolant label.

■ **If you spill coolant**

Be sure to wash it off with water to prevent damage to parts or paint.

Radiator and condenser

Check the radiator and condenser and clear any foreign objects. If either of the above parts are extremely dirty or you are not sure of their condition, have your vehicle checked by your Toyota dealer.

 CAUTION

■ **When the engine is hot**

Do not touch the radiator or condenser as they may be hot and may cause burns.

Brake fluid

■ **Checking fluid level**

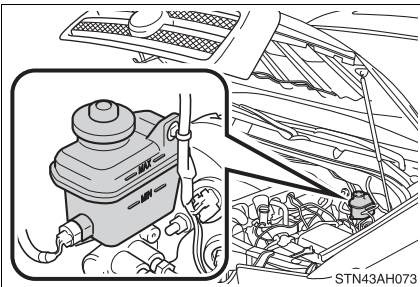

The brake fluid level should be between the MAX and MIN lines on the reservoir.

■ **Adding fluid**

Make sure to check the fluid type and prepare the necessary items.

Fluid type	FMVSS No.116 DOT 3 or SAE J1703 brake fluid
Items	Rag or paper towel

■ **Brake fluid can absorb moisture from the air**

Excess moisture in the fluid can cause a dangerous loss of braking efficiency. Use only newly opened brake fluid.

 **CAUTION**

■ **When filling the reservoir**

Take care because brake fluid can harm your hands or eyes and damage painted surfaces.

If fluid gets on your hands or in your eyes, flush the affected area with clean water immediately.

If you still experience discomfort, see a doctor.

 **NOTICE**

■ **If the fluid level is low or high**

It is normal for the brake fluid level to go down slightly as the brake pads wear or when the fluid level in the accumulator is high.

If the reservoir needs frequent refilling, it may indicate a serious problem.

■ **If you spill fluid**

Be sure to wash it off with water to prevent damage to parts or paint.

Power steering fluid

■ Fluid level

The fluid level should be within the appropriate range.

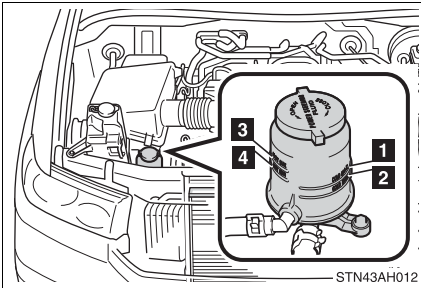

- 1 Full (when cold)
- 2 Add fluid (when cold)
- 3 Full (when hot)
- 4 Add fluid (when hot)

Hot: Vehicle has been driven around 50 mph (80 km/h) for 20 minutes, or slightly longer in frigid temperatures. (Fluid temperature, 140°F - 175°F [60°C - 80°C])

Cold: Engine has not been run for about 5 hours. (Room temperature, 50°F - 85°F [10°C - 30°C])

■ Checking the fluid level

Make sure to check the fluid type and prepare the necessary items.

Fluid type	Automatic transmission fluid DEXRON® II or III
Items	Rag or paper towel

STEP 1 Clean all dirt off the reservoir.

STEP 2 Remove the cap by turning it counterclockwise.

STEP 3 Wipe the dipstick clean.

STEP 4 Reinstall and remove the reservoir cap again.

STEP 5 Check the fluid level.

⚠ CAUTION

■ Checking the fluid level

Take care, as the reservoir may be hot.

 NOTICE

■ **When adding fluid**

Avoid overfilling, or the power steering may be damaged.

■ **After replacing the reservoir cap**

Check the steering box case, vane pump and hose connections for leaks or damage.

Battery

■ **Battery exterior**

Make sure that the battery terminals are not corroded and that there are no loose connections, cracks, or loose clamps.

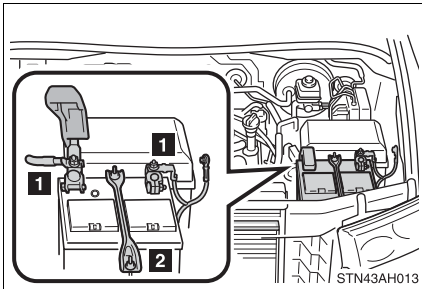

1 Terminals

2 Hold-down clamp

■ **Before recharging**

When recharging, the battery produces hydrogen gas which is flammable and explosive. Therefore, before recharging:

- If recharging with the battery installed on the vehicle, be sure to disconnect the ground cable.
- Make sure the power switch on the charger is off when connecting and disconnecting the charger cables to the battery.

 **CAUTION****■ Chemicals in the battery**

A battery contains poisonous and corrosive sulfuric acid and may produce hydrogen gas which is flammable and explosive. To reduce the risk of death or serious injury, take the following precautions while working on or near battery:

- Do not cause sparks by touching the battery terminals with tools.
- Do not smoke or light a match near the battery.
- Avoid contact with eyes, skin and clothes.
- Never inhale or swallow electrolyte.
- Wear protective safety glasses when working near the battery.
- Keep children away from the battery.

■ Where to safely charge the battery

Always charge the battery in an open area. Do not charge the battery in a garage or closed room where there is not sufficient ventilation.

■ How to recharge the battery

Only perform a slow charge (5A or less).

The battery may explode if charged at a quicker rate.

■ Emergency measures regarding electrolyte

- If electrolyte gets in your eyes
Flush your eyes with clean water for at least 15 minutes and get immediate medical attention. If possible, continue to apply water with a sponge or cloth while traveling to the nearest medical facility.
- If electrolyte gets on your skin
Wash the affected area thoroughly. If you feel pain or burning, get medical attention immediately.
- If electrolyte gets on your clothes
It can soak through clothing on to your skin. Immediately take off the clothing and follow the procedure above if necessary.
- If you accidentally swallow electrolyte
Drink a large quantity of water or milk. Get emergency medical attention immediately.

 NOTICE

When recharging the battery

Never recharge the battery while the engine is running. Also, be sure all accessories are turned off.

Washer fluid

Add washer fluid in the following situations.

- Any washer does not work.
- The low washer fluid warning light comes on. (if equipped)
- The warning message appears on the multi-information display. (if equipped)

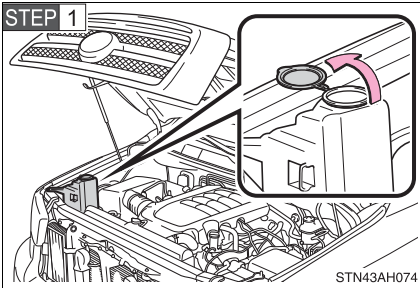

Open the lid.

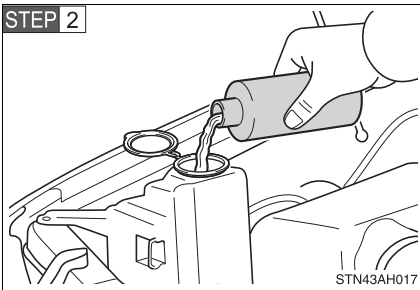

Add washer fluid.

 **CAUTION****■ When refilling the washer fluid**

Do not refill the washer fluid when the engine is hot or running, as the washer fluid contains alcohol and may catch fire if spilled on the engine etc.

 **NOTICE****■ Do not use any fluid other than washer fluid**

Do not use soapy water or engine antifreeze instead of washer fluid. Doing so may cause streaking on the vehicle's painted surfaces.

■ Diluting washer fluid

Dilute washer fluid with water as necessary.
Refer to the freezing temperatures listed on the washer fluid tank.

4-3. Do-it-yourself maintenance

Tires

Replace or rotate tires in accordance with maintenance schedules and treadwear.

■ Checking tires

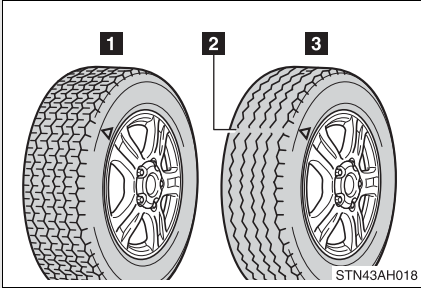

- 1 New tread
- 2 Treadwear indicator
- 3 Worn tread

The location of treadwear indicators is shown by the “TWI” or “△” marks, etc., molded on the sidewall of each tire.

Check spare tire condition and inflation pressure if not rotated.

■ Tire rotation

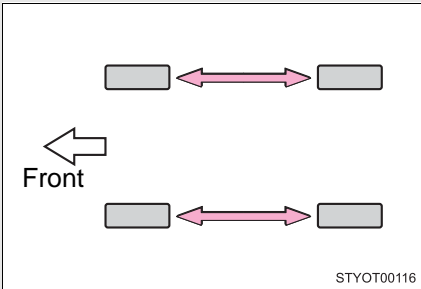

Rotate the tires in the order shown.

To equalize tire wear and extend tire life, Toyota recommends that tire rotation is carried out at the same interval as tire inspection.

Do not fail to initialize the tire pressure warning system after tire rotation.

■ The tire pressure warning system

Your Toyota is equipped with a tire pressure warning system that uses tire pressure warning valves and transmitters to detect low tire inflation pressure before serious problems arise. (→P. 598)

Installing tire pressure warning valves and transmitters

When replacing tires or wheels, tire pressure warning valves and transmitters must also be installed.

When new tire pressure warning valves and transmitters are installed, new tire pressure warning valve and transmitter ID codes must be registered in the tire pressure warning computer and tire pressure warning system must be initialized. Have tire pressure warning valve and transmitter ID codes registered by your Toyota dealer. (→P. 544)

Initializing the tire pressure warning system

■ The tire pressure warning system must be initialized in the following circumstances:

- When rotating the tires on vehicles differing with front and rear tire inflation pressures.
- When changing the tire size.

When the tire pressure warning system is initialized, the current tire inflation pressure is set as the pressure benchmark.

■ How to initialize the tire pressure warning system

STEP 1 Park the vehicle in safe place and turn the engine switch off.

While the vehicle is moving, initialization is not performed.

STEP 2 Adjust the tire inflation pressure to the specified cold tire inflation pressure level. (→P. 666)

Make sure to adjust the tire pressure to the specified cold tire inflation pressure level. The tire pressure warning system will operate based on this pressure level.

STEP 3 Turn the engine switch to the ON position.

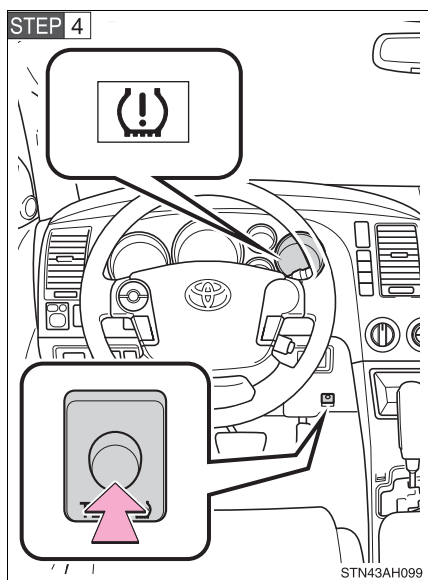

Push and hold the tire pressure warning reset switch until the tire pressure warning light blinks slowly 3 times.

STEP 5 Wait for several minutes with the engine switch on, and then turn the engine switch to the ACC or LOCK position.

Registering ID codes

The tire pressure warning valve and transmitter is equipped with a unique ID code. When replacing a tire pressure warning valve and transmitter, it is necessary to register the ID code of tire pressure warning valve and transmitter. Have the ID code registered by your Toyota dealer.

■ When to replace your vehicle's tires

Tires should be replaced if:

- You have tire damage such as cuts, splits, cracks deep enough to expose the fabric or bulges indicating internal damage
- A tire goes flat repeatedly or cannot be properly repaired due to the size or location of a cut or other damage

If you are not sure, consult with your Toyota dealer.

■ Replacing tires and wheels

If the ID code of the tire pressure warning valve and transmitter is not registered, the tire pressure warning system will not work properly. After driving for about 20 minutes, the tire pressure warning light comes on after blinking for 1 minute to indicate a system malfunction.

■ Tire life

Any tire over 6 years old must be checked by a qualified technician even if they have seldom or never been used or damage is not obvious.

■ If the tread wears down below 0.16 in. (4 mm) on snow tires

The effectiveness of snow tires is lost.

■ Maximum load of tire

Check that the number given by dividing the maximum load by 1.10 of the replacement tire is greater than 1/2 of the Gross Axle Weight Ratings (GAWR) of either the front axle or the rear axle, whichever is greater.

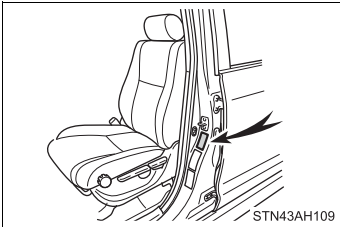

For the GAWR, see the Certification Label. For the maximum load of the tire, see the load limit at maximum cold tire inflation pressure mentioned on the sidewall of the tire. (→ P. 673)

■ Tire types

1 Summer tires

Summer tires are high-speed performance tires best suited to highway driving under dry conditions. Since summer tires do not have the same traction performance as snow tires, summer tires are inadequate for driving on snow-covered or icy roads. For driving on snow-covered roads or icy roads, the use of snow tires is recommended. When installing snow tires, be sure to replace all four tires.

2 All season tires

All season tires are designed to provide better traction in snow and to be adequate for driving in most winter conditions, as well as for use year round. All season tires, however, do not have adequate traction performance compared with snow tires in heavy or loose snow. Also, all season tires fall short in acceleration and handling performance compared with summer tires in highway driving.

3 Snow tires

For driving on snow-covered roads or icy roads, we recommend using snow tires. If you need snow tires, select tires of the same size, construction and load capacity as the originally installed tires. Since your vehicle has radial tires as original equipment, make sure your snow tires also have radial construction. Do not install studded tires without first checking local regulations for possible restriction. Snow tires should be installed on all wheels. (→P. 260)

■ **Initializing the tire pressure warning system**

Initialize the tires with the tire inflation pressure adjusted to the specified level.

■ **If you push the tire pressure warning reset switch accidentally**

If initialization is performed, adjust the tire inflation pressure to the specified level and initialize the tire pressure warning system again.

■ **When the initialization of the tire pressure warning system has failed**

Initialization can be completed in several minutes. However, in the following cases, the settings have not been recorded and the system will not operate properly. If repeated attempts to record tire inflation pressure settings are unsuccessful, have the vehicle inspected by your Toyota dealer.

- When operating the tire pressure warning reset switch, the tire pressure warning light does not flash 3 times.
- After carrying out the initialization procedure, the tire pressure warning light blinks for 1 minute and then stays on after driving for about 20 minutes.

■ **Routine tire inflation pressure checks**

- The tire pressure warning system does not replace routine tire inflation pressure checks. Make sure to check tire inflation pressure as part of your routine of daily vehicle checks.

■ Tire pressure warning system certification

FCC ID: GQ4-32T

FCC ID: GQ4-37R

IC ID: 1470A-13T

IC ID: 1470A-9R

► For vehicles sold in U.S.A.

This device complies with Part 15 of the FCC Rules. Operation is subject to the following two conditions: (1) this device may not cause harmful interference, and (2) this device must accept any interference received, including interference that may cause undesired operation.

FCC WARNING:

Changes or modifications not expressly approved by the party responsible for compliance could void the user's authority to operate the equipment.

► For vehicles sold in Canada

Operation is subject to the following two conditions: (1) this device may not cause interference, and (2) this device must accept any interference, including interference that may cause undesired operation of the device.

CAUTION

■ When inspecting or replacing tires

Observe the following precautions to prevent accidents. Failure to do so may cause damage to parts of the drive train, as well as dangerous handling characteristics, which may lead to an accident resulting in death or serious injury.

- Do not mix tires of different makes, models or tread patterns. Also, do not mix tires of remarkably different treadwear.
- Do not use tire sizes other than those recommended by Toyota.
- Do not mix differently constructed tires (radial, bias-belted or bias-ply tires).
- Do not mix summer, all season and winter tires.

 CAUTION

■ **When inspecting or replacing tires**

- Do not use tires that have been used on another vehicle.
- Do not use tires if you do not know how they were used previously.

■ **When initializing the tire pressure warning system**

- Do not push the tire pressure warning reset switch without first adjusting the tire inflation pressure to the specified level. Otherwise, the tire pressure warning light may not come on even if the tire inflation pressure is low, or it may come on when the tire inflation pressure is actually normal.

 NOTICE

■ **Repairing or replacing tires, wheels, tire pressure warning valves and transmitters and tire valve caps**

- When removing or fitting the wheels, tires or the tire pressure warning valve and transmitter, contact your Toyota dealer as the tire pressure warning valve and transmitter may be damaged if not handled correctly.
- When replacing tire valve caps, do not use tire valve caps other than those specified. The cap may become stuck.

■ **To avoid damaging the tire pressure warning valves and transmitters**

Do not use liquid sealants on flat tires.

■ **Driving on rough roads**

Take particular care when driving on roads with loose surfaces or potholes.

These conditions may cause losses in tire inflation pressure, reducing the cushioning ability of the tires. In addition driving on rough roads may cause damage to the tires themselves, as well as the vehicle's wheels and body.

■ **If tire inflation pressures become low while driving**

Do not continue driving, or your tires and/or wheels may be ruined.

4-3. Do-it-yourself maintenance

Tire inflation pressure

■ Tire inflation pressure

The recommended cold tire inflation pressure and tire size is displayed on the tire and loading information label. (→P. 673)

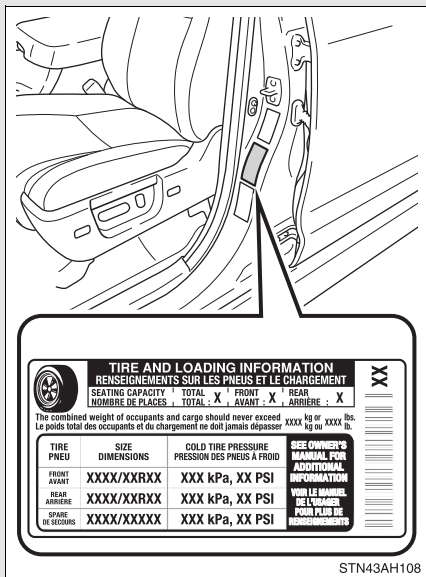

■ Inspection and adjustment procedure

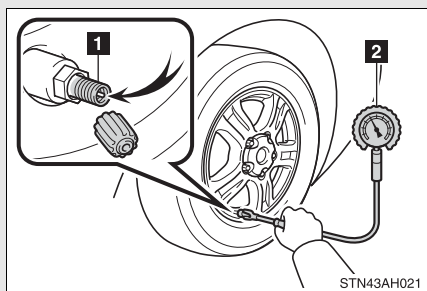

- 1 Tire valve
- 2 Tire pressure gauge

STEP 1 Remove the tire valve cap.

STEP 2 Press the tip of the tire pressure gauge onto the tire valve.

STEP 3 Read the pressure using the graduations of the gauge.

STEP 4 If the tire inflation pressure is not within the recommended levels, adjust inflate the tire.

If you add too much air, press the center of the valve to lower.

STEP 5 After completing the tire inflation pressure measurement and adjustment, apply soapy water to the valve and check for leakage.

STEP 6 Reinstall the tire valve cap.

■ Tire inflation pressure check interval

You should check tire pressure every two weeks, or at least once a month.

Do not forget to check the spare.

■ Effects of incorrect tire inflation pressure

Driving with incorrect tire inflation pressure may result in the following:

- Reduced fuel efficiency
- Reduced driving comfort and tire life
- Reduced safety
- Damage to the drive train

If a tire needs frequent refilling, have it checked by your Toyota dealer.

■ Instructions for checking tire inflation pressure

When checking tire inflation pressure, observe the following:

- Check only when the tires are cold.
If your vehicle has been parked for at least 3 hours and has not been driven for more than 1 mile or 1.5 km, you will get an accurate cold tire inflation pressure reading.
- Always use a tire pressure gauge.
The appearance of the tire can be misleading. In addition, tire inflation pressures that are even just a few pounds off can degrade ride and handling.
- Do not bleed or reduce tire inflation pressure after driving. It is normal for the tire inflation pressure to be higher after driving.
- Never exceed the vehicle capacity weight.
Passengers and luggage weight should be placed so that the vehicle is balanced.

CAUTION

■ Proper inflation is critical to save tire performance

Keep your tires properly inflated.

Otherwise, the following conditions may occur and result in an accident causing death or serious injury.

- Excessive wear
- Uneven wear
- Poor handling
- Possibility of blowouts resulting from overheated tires
- Poor sealing of the tire bead
- Wheel deformation and/or tire separation
- A greater possibility of tire damage from road hazards



NOTICE

■ When inspecting and adjusting tire inflation pressure

Be sure to reinstall the tire valve caps.

Without the valve caps, dirt or moisture could get into the valve and cause air leakage, which could result in an accident. If the caps have been lost, replace them as soon as possible.

Wheels

If a wheel is bent, cracked or heavily corroded, it should be replaced.

Otherwise, the tire may separate from the wheel or cause loss of handling control.

■ Wheel selection

When replacing wheels, care should be taken to ensure that they are equivalent to those removed in load capacity, diameter, rim width, and inset*.

Replacement wheels are available at your Toyota dealer.

*: Conventionally referred to as “offset”.

Toyota does not recommend using:

- Wheels of different sizes or types
- Used wheels
- Bent wheels that have been straightened

■ Wheel precautions

- Use only Toyota wheel nuts and wrench designed for use with your aluminum wheels.
- When rotating, repairing or changing your tires, check that the wheel nuts are still tight after driving 100 miles (160 km).
- Be careful not to damage the aluminum wheels when using tire chains.
- Use only Toyota genuine balance weights or equivalent and a plastic or rubber hammer when balancing your wheels.

■ When replacing wheels

The wheels of your Toyota are equipped with tire pressure warning valves and transmitters (except for spare tire) that allow the tire pressure warning system to provide advanced warning in the event of a loss in tire inflation pressure. Whenever wheels are replaced, the tire pressure warning valves and transmitters must be installed. (→P. 543)

CAUTION

■ When replacing wheels

- Do not use wheels that are a different size from those recommended in the Owner's Manual, as this may result in loss of handling control.
- Never use an inner tube in a leaking wheel which is designed for a tubeless tire. Doing so may result in an accident, causing death or serious injury.

NOTICE

■ Replacing tire pressure warning valves and transmitters

- Because tire repair or replacement may affect the tire pressure warning valves and transmitters, make sure to have tires serviced by your Toyota dealer or other qualified service shop. In addition, make sure to purchase your tire pressure warning valves and transmitters at your Toyota dealer.
- Ensure that only genuine Toyota wheels are used on your vehicle. Tire pressure warning valves and transmitters may not work properly with non-genuine wheels.

4-3. Do-it-yourself maintenance

Air conditioning filter

The air conditioning filter must be cleaned or changed regularly to maintain air conditioning efficiency.

■ Removal method

STEP 1 Turn the engine switch off.

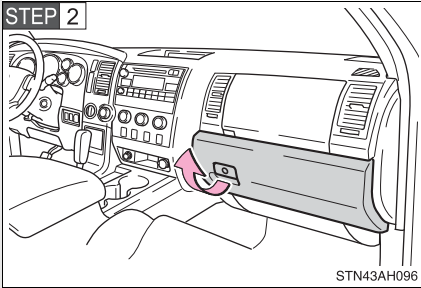

Open the glove box.

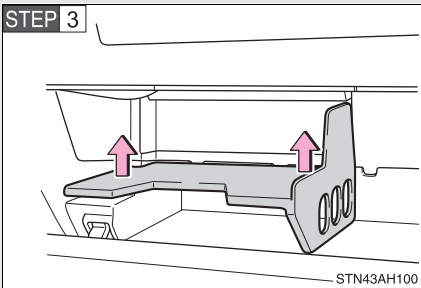

Remove the tray.

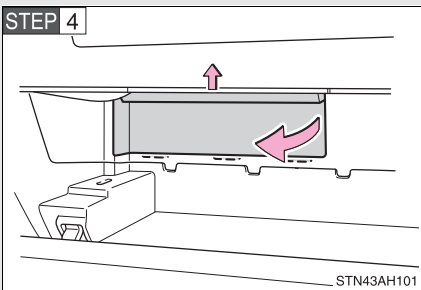

Remove the cover by sliding up while pulling toward you.

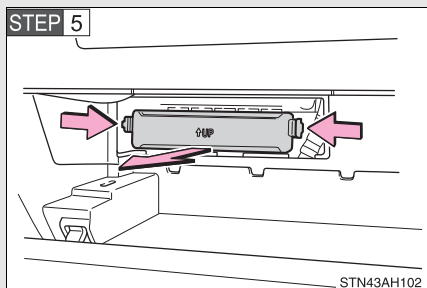

Remove the filter cover.

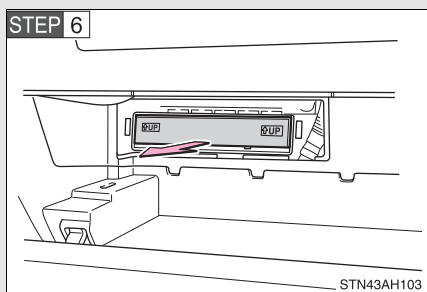

Pull the filter out of the filter outlet.

■ Cleaning method

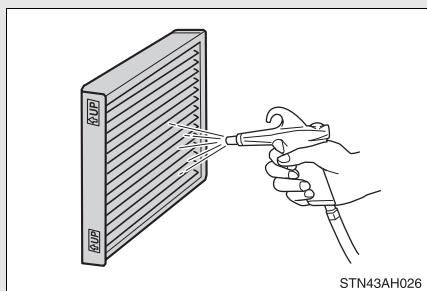

If the filter is dirty, clean by blowing compressed air through the filter from the downward side.

Hold the air gun 2 in. (5 cm) from the filter and blow for approximately 2 minutes at 72 psi (500 kPa, 5.0 kgf/cm² or bar).

If it is not available, have the filter cleaned by your Toyota dealer.

■ Replacement method

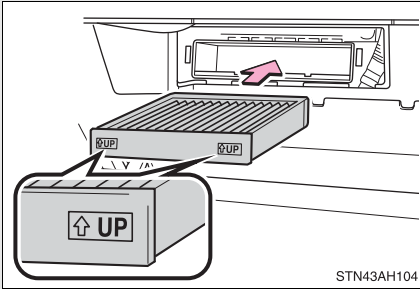

Remove the air conditioning filter and replace it with a new one.

The “↑UP” marks shown on the filter should be pointing up.

■ Checking interval

Inspect, clean and replace the air conditioning filter according to the maintenance schedule. In dusty areas or areas with heavy traffic flow, more frequent cleaning or early replacement may be required. (For scheduled maintenance information, please refer to the “Scheduled Maintenance Guide” or “Owner’s Manual Supplement”.)

■ If air flow from the vents decreases dramatically

The filter may be clogged. Check the filter and replace if necessary.

⚠ NOTICE

■ To prevent damage to the system

- When using the air conditioning system, make sure that a filter is always installed.
- When cleaning the filter, do not clean the filter with water.

Wireless remote control battery

Replace the battery with a new one if it is discharged.

■ **You will need the following items:**

Lithium battery CR2032

■ **Replacing the battery**

STEP 1

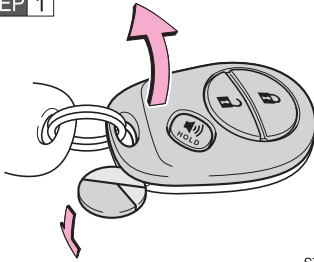

STN43AH028

Remove the cover using a coin protected with tape etc.

STEP 2

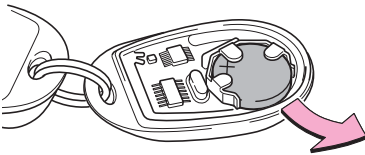

STN43AH029

Remove the discharged transmitter battery.

Insert a new battery with the "+" terminal facing up.

■ If the wireless remote control battery is discharged

The following symptoms may occur.

- The wireless remote control will not function properly.
- The operational range is reduced.

■ Use a CR2032 lithium battery

- Batteries can be purchased at your Toyota dealer, jewelers, or camera stores.
- Replace only with the same or equivalent type recommended by your Toyota dealer.
- Dispose of used batteries according to the local laws.

CAUTION

■ Removed battery and other parts

Keep away from children.

These parts are small and if swallowed by a child they can cause choking.

NOTICE

■ For normal operation after replacing the battery

Observe the following precautions to prevent accidents.

- Always work with dry hands.
Moisture may cause the battery to rust.
- Do not touch or move any other components inside the remote control.
- Do not bend either of the battery terminals.

4-3. Do-it-yourself maintenance

Checking and replacing fuses

If any of the electrical components do not operate, a fuse may have blown. If this happens, check and replace the fuses as necessary.

STEP 1 Turn the engine switch off.

STEP 2 The fuses are located in the following places. To check the fuses, follow the instructions below.

► Engine compartment

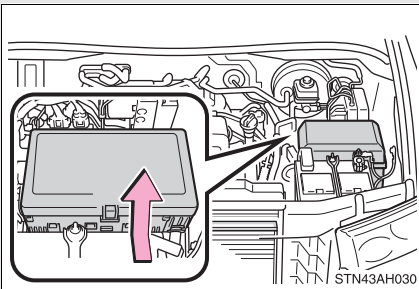

Push the tab in and lift the lid off.

► Under the instrument panel

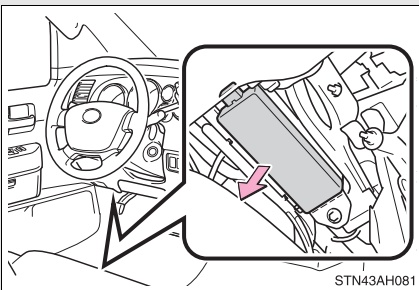

Remove the lid.

STEP 3 After a system failure, see “Fuse layout and amperage ratings” (→P. 563) for details about which fuse to check.

STEP 4

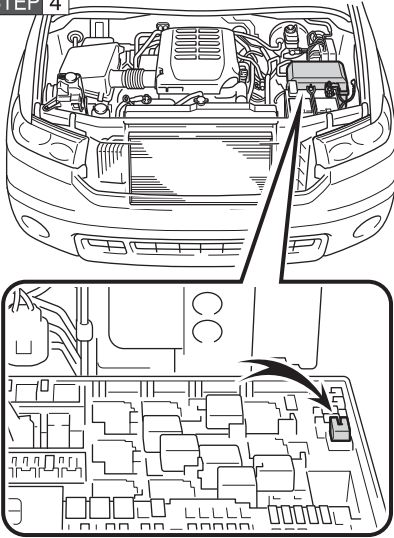

STN43AH082

Remove the fuse with the pull-out tool.

STEP 5 Check if the fuse has blown.

► Type A

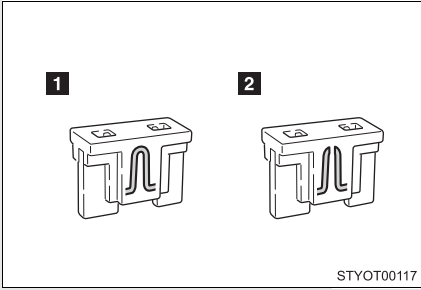

1 Normal fuse

2 Blown fuse

Replace it with one of an appropriate amperage rating. The amperage rating can be found on the fuse box lid.

► Type B

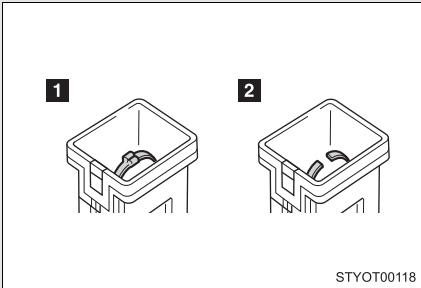

1 Normal fuse

2 Blown fuse

Replace it with one of an appropriate amperage rating. The amperage rating can be found on the fuse box lid.

► Type C

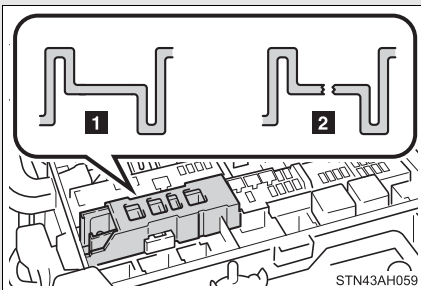

1 Normal fuse

2 Blown fuse

Contact your Toyota dealer.

Fuse layout and amperage ratings

■ **Engine compartment**

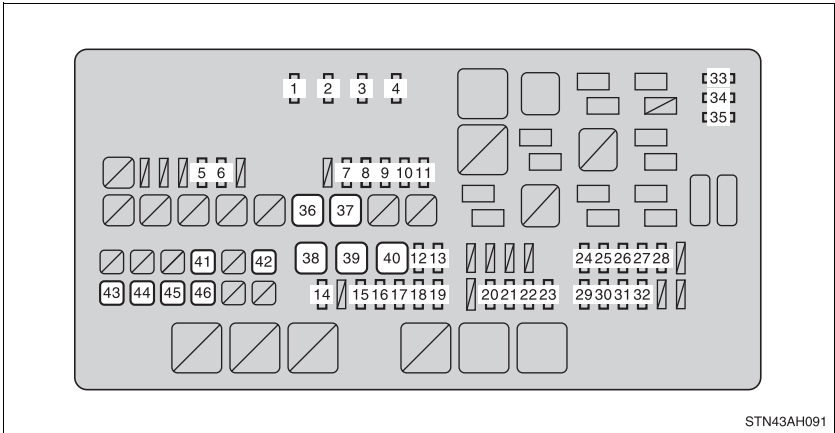

Fuse		Ampere	Circuit
1	A/F	15 A	Multiport fuel injection system/ sequential multiport fuel injection system
2	HORN	10 A	Horn
3	EFI NO.1	25 A	Multiport fuel injection system/ sequential multiport fuel injection system
4	IG2 MAIN	30 A	INJ, MET, IGN fuses
5	DEICER	20 A	Front windshield wiper de-icer
6	TOW TAIL	30 A	Trailer lights (tail lights)
7	POWER NO.4	25 A	Power windows
8	POWER NO.2	30 A	Power back windows
9	FOG	15 A	Front fog lights

Fuse		Ampere	Circuit
10	STOP	15 A	Stop lights, high mounted stop-light, vehicle stability control system, anti-lock brake system, shift lock system, multiport fuel injection system/sequential multiport fuel injection system, towing converter
11	TOW BRK	30 A	Trailer brake controller
12	IMB	7.5 A	Multiport fuel injection system/sequential multiport fuel injection system
13	AM2	7.5 A	Starting system
14	TOWING	30 A	Towing converter
15	ALT-S	5 A	Charging system
16	TURN-HAZ	15 A	Turn signal lights, emergency flashers, towing converter
17	F/PMP	15 A	No circuit
18	ETCS	10 A	Multiport fuel injection system/sequential multiport fuel injection system, electric throttle control system
19	MET-B	5 A	Gauges and meters
20	AMP	30 A	Audio system, rear view monitor, navigation system, rear seat entertainment system
21	RAD NO.1	15 A	Audio system, rear view monitor, navigation system, rear seat entertainment system

Fuse		Ampere	Circuit
22	ECU-B1	7.5 A	Multiplex communication system, Multiport fuel injection system/ sequential multiport fuel injection system, auto anti-glare inside rear view mirror, power outlets, power front driver's seat, power tilt and power telescopic
23	DOME	7.5 A	Interior lights, personal lights, vanity lights, engine switch light, foot light, door courtesy lights, accessory meter
24	HEAD LH	15 A	Left-hand headlight (high beam)
25	HEAD LL	15 A	Left-hand headlight (low beam)
26	INJ	10 A	Multiport fuel injection system/ sequential multiport fuel injection system, ignition system
27	MET	7.5 A	Gauges and meters
28	IGN	10 A	SRS airbag system, multiport fuel injection system/sequential multiport fuel injection system, cruise control system
29	HEAD RH	15 A	Right-hand headlight (high beam)
30	HEAD RL	15 A	Right-hand headlight (low beam)
31	EFI NO.2	10 A	Multiport fuel injection system/ sequential multiport fuel injection system, leak detection pump
32	DEF I/UP	5 A	No circuit
33	SPARE	5 A	Spare fuse
34	SPARE	15 A	Spare fuse

Fuse		Ampere	Circuit
35	SPARE	30 A	Spare fuse
36	DEFOG	40 A	Back window defogger
37	SUB BATT	40 A	Trailer towing
38	ABS1	50 A	Anti-lock brake system, vehicle stability control system
39	ABS2	40 A	Anti-lock brake system, vehicle stability control system
40	ST	30 A	Starting system
41	HTR	50 A	Air conditioning system
42	LH-J/B	150 A	AM1, TAIL, PANEL, ACC, CIG, LH-IG, 4WD, ECU-IG No.1, BK/UP LP, SEAT-HTR, A/C IG, ECU-IG No.2, WSH, WIPER, OBD, A/C, TI&TE, FR P/SEAT RH, MIR, DR/LCK, FR P/SEAT LH, CARGO LP, PWR OUTLET, POWER No.1 fuses
43	ALT	180 A*	LH-J/B, HTR, SUB BATT, TOW BRK, STOP, FOG, TOW TAIL, DEICER fuses
		140 A*	
44	A/PUMP NO.1	50 A	Multiport fuel injection system/ sequential multiport fuel injection system
45	A/PUMP NO.2	50 A	Multiport fuel injection system/ sequential multiport fuel injection system
46	MAIN	40 A	HEAD LL, HEAD RL, HEAD LH, HEAD RH fuses

*: Replace the fuse with one of the same ampere rating as the original.

■ Under the instrument panel

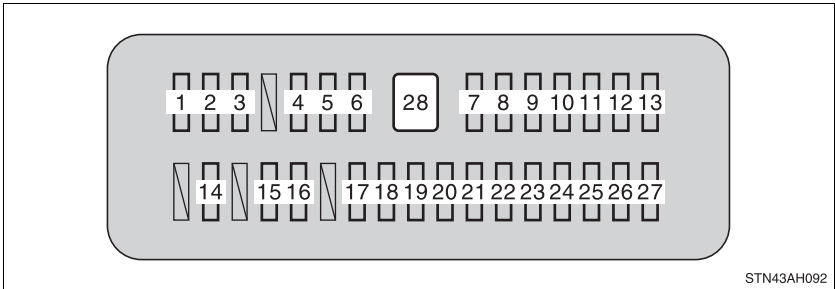

	Fuse	Ampere	Circuit
1	INVERTER	15 A	Power outlet (115 V)
2	FR P/SEAT LH	30 A	Power front driver's seat
3	DR/LCK	25 A	Multiplex communication system
4	OBD	7.5 A	On-board diagnosis system
5	PWR OUTLET	15 A	Power outlets
6	CARGO LP	7.5 A	Cargo lamp
7	AM1	7.5 A	Shift lock system, starting system
8	A/C	7.5 A	Air conditioning system
9	MIR	15 A	Outside rear view mirror control, outside rear view mirror heaters
10	POWER No.3	20 A	Power windows
11	FR P/SEAT RH	30 A	Power front passenger seat
12	TI&TE	15 A	Power tilt and power telescopic
13	S/ROOF	25 A	Electric moon roof

Fuse		Ampere	Circuit
14	ECU-IG No.1	7.5 A	Anti-lock brake system, vehicle stability control system, multiplex communication system, intuitive parking assist system, power front driver's seat, power tilt and power telescopic, shift lock, tire pressure warning system, accessory meter, trailer towing, power outlet, electric moon roof
15	LH-IG	7.5 A	Back-up lights, charging system, gauge and meters, turn signal lights, air conditioning system, seat heaters, back window defogger
16	4WD	20 A	Four-wheel drive control system
17	WSH	20 A	Window washer
18	WIPER	30 A	Wiper and washer
19	ECU-IG No.2	7.5 A	Multiplex communication system
20	TAIL	15 A	Tail lights, trailer lights (tail lights), parking lights, outer foot lights
21	A/C IG	10 A	Air conditioning system
22	TOW BK/UP	7.5A	Trailer lights
23	SEAT-HTR	20 A	Seat heaters or heater and ventilated seats
24	PANEL	7.5 A	Instrument panel lights, glove box light, accessory meter, audio system, rear view monitor, navigation system, rear seat entertainment system, gauges and meters, air conditioning system

Fuse		Ampere	Circuit
25	ACC	7.5 A	Accessory meter, audio system, rear seat entertainment system, rear view monitor, navigation system, back-up lights, trailer lights (back-up lights), multiplex communication system, power outlet, outside rear view mirror
26	BK/UP LP	10 A	Back-up light, gauges and meters
27	CIG	15 A	Cigarette lighter
28	POWER No.1	30 A	Power windows, power back window

■ After a fuse is replaced

- If the lights do not turn on even after the fuse has been replaced, a bulb may need replacement. (→P. 571)
- If the replaced fuse blows again, have the vehicle inspected by your Toyota dealer.

■ If there is an overload in the circuits

The fuses are designed to blow before the entire wiring harness is damaged.

CAUTION

■ To prevent system breakdowns and vehicle fire

Observe the following precautions.

Failing to do so may cause damage, and possibly a fire or injury.

- Never use a fuse of a higher amperage rating than indicated, or use any other object in place of a fuse.
- Always use a genuine Toyota fuse or equivalent.
Never replace a fuse with a wire, even as a temporary fix.
This can cause extensive damage or even fire.
- Do not modify the fuse or the fuse box.



NOTICE

■ Before replacing fuses

Have the cause of electrical overload determined and repaired by your Toyota dealer as soon as possible.

Light bulbs

You may replace the following bulbs yourself. The difficulty level of replacement varies depending on the bulb. If necessary bulb replacement seems difficult to perform, contact your Toyota dealer.

For more information about replacing other light bulbs, contact your Toyota dealer.

■ Prepare a replacement light bulb.

Check the wattage of the light bulb being replaced. (→P. 668)

■ Front bulb locations

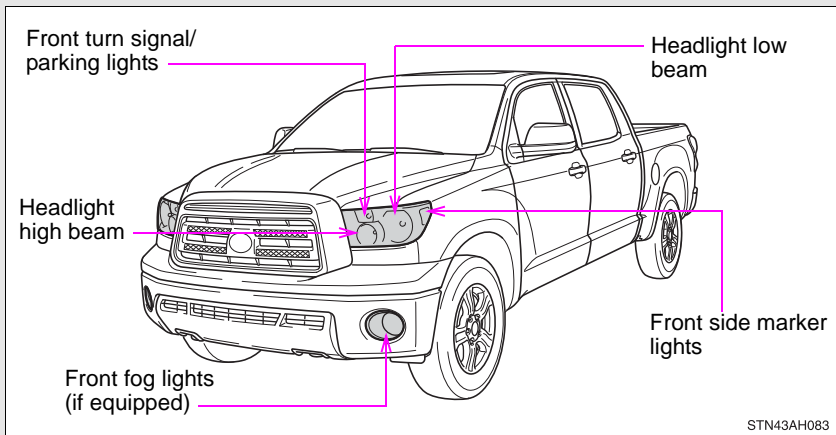

■ Rear bulb locations

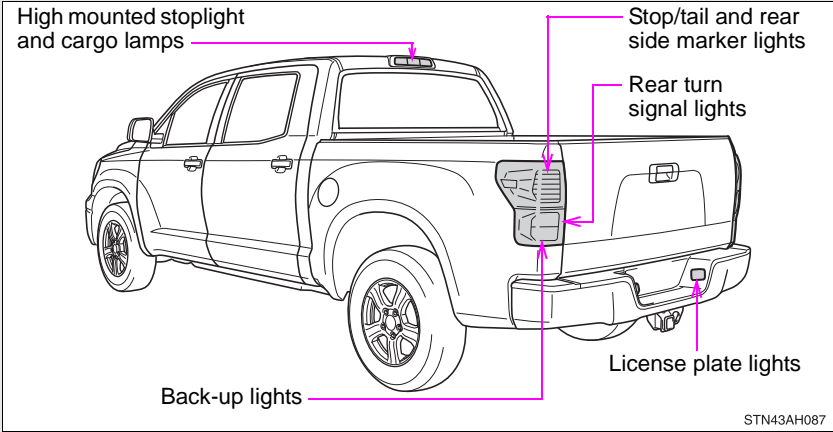

Replacing light bulbs

■ Headlight high beam

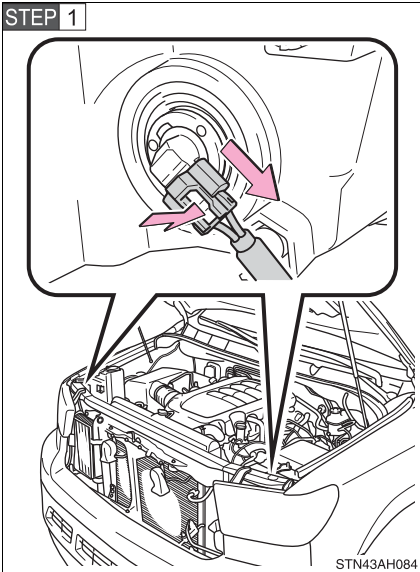

Unplug the connector while depressing the lock release.

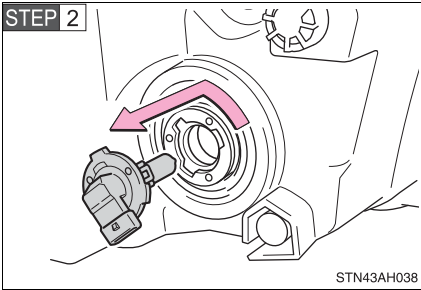

Turn the bulb base counterclockwise.

■ Headlight low beam

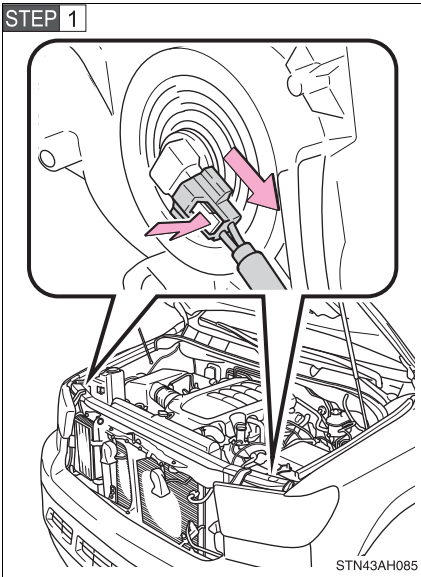

Unplug the connector while depressing the lock release.

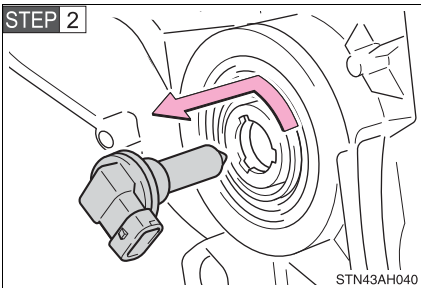

Turn the bulb base counterclockwise.

■ Front turn signal/parking lights

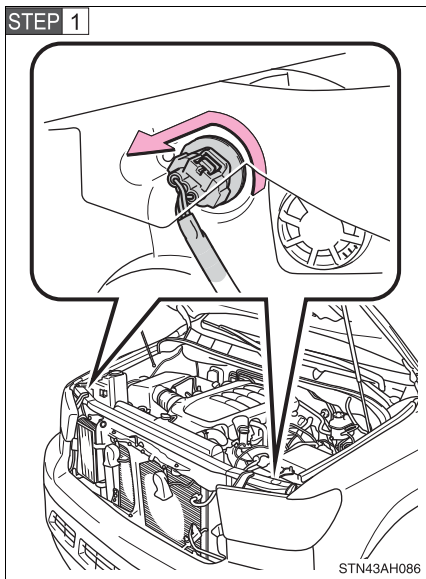

Turn the bulb base counterclockwise.

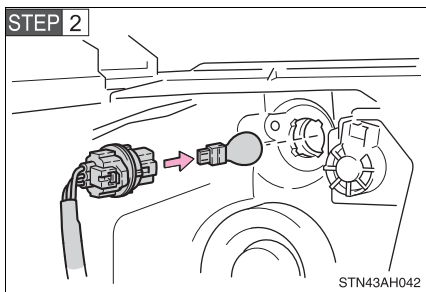

Remove the light bulb.

■ Front side marker lights

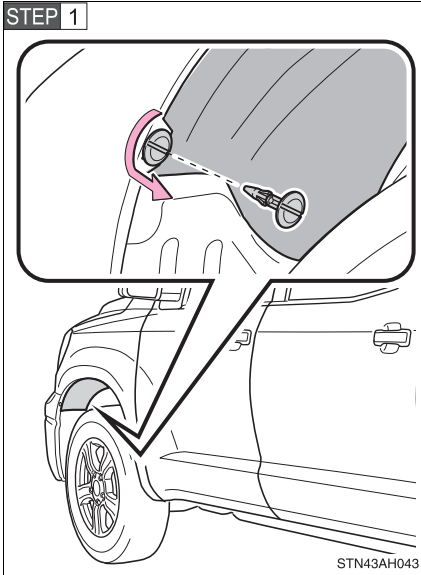

Remove the fender liner clip.

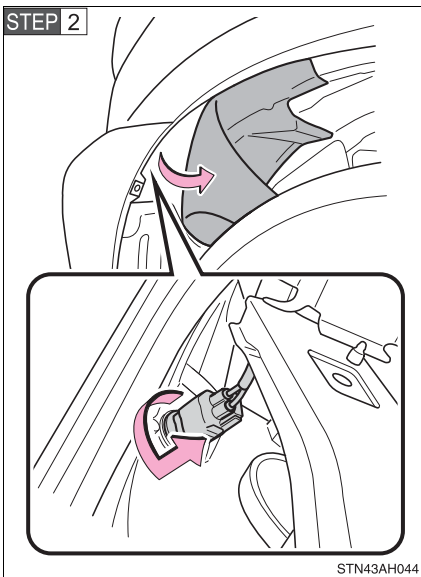

Partly remove the fender liner and turn the bulb base counter-clockwise.

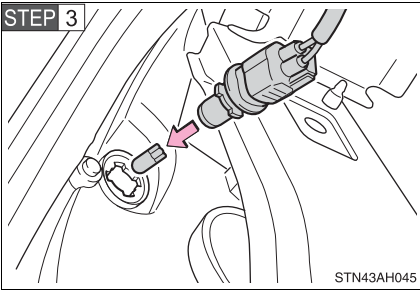

Remove the light bulb.

■ Front fog lights (if equipped)

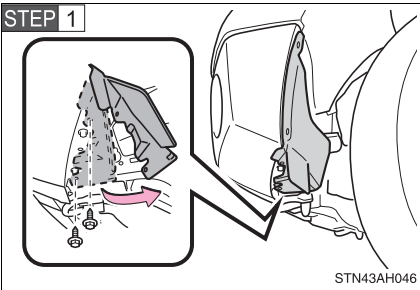

Remove the bolts and partly remove the fender liner.

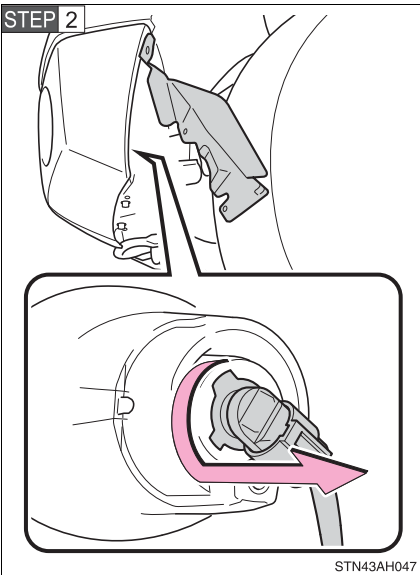

Turn the bulb counterclockwise.

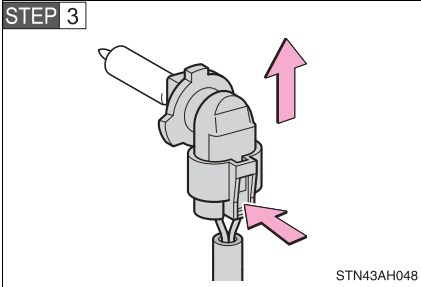

Unplug the connector while depressing the lock release.

■ Stop/tail and rear side marker lights, rear turn signal lights and back-up lights

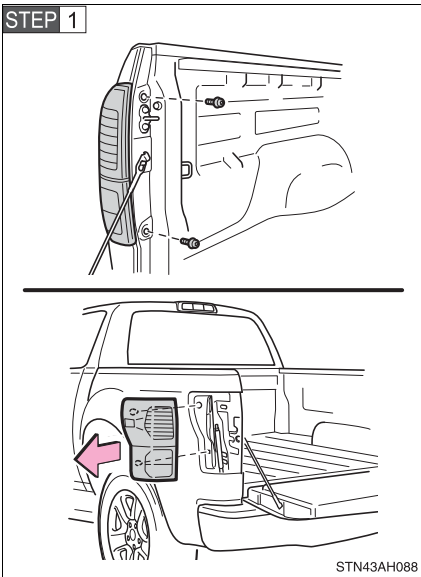

Remove the bolts and rear combination assembly.

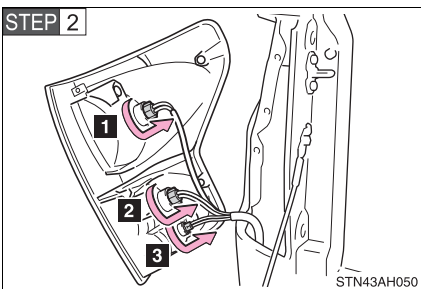

Turn the bulb bases counter-clockwise.

- 1** Stop/tail and rear side marker light
- 2** Rear turn signal light
- 3** Back-up light

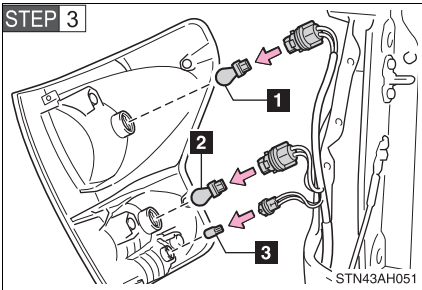

Remove the light bulb.

- 1** Stop/tail and rear side marker light
- 2** Rear turn signal light
- 3** Back-up light

■ High mounted stoplight and cargo lamps

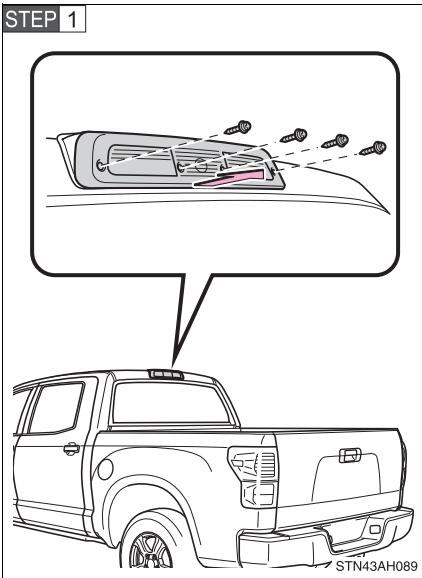

Remove the screws and cover.

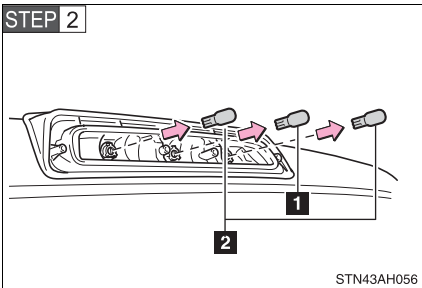

Remove the light bulb.

- 1** High mounted stoplight
- 2** Cargo lamps

■ License plate lights

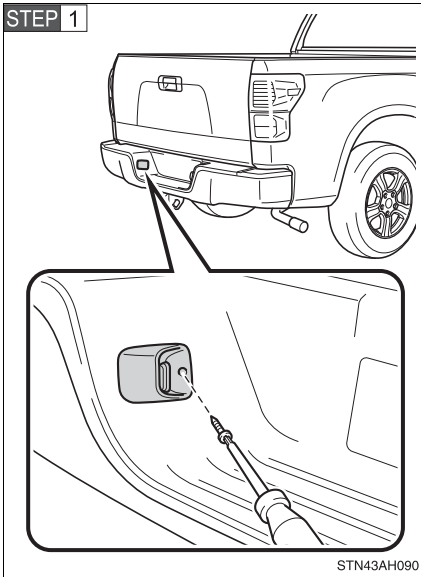

Remove the screw and light unit.

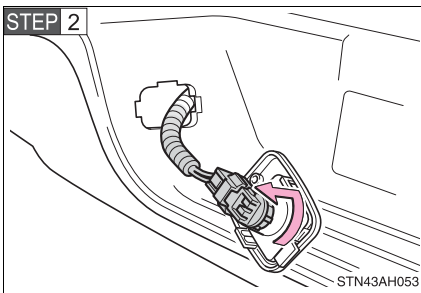

Turn the bulb base counterclockwise.

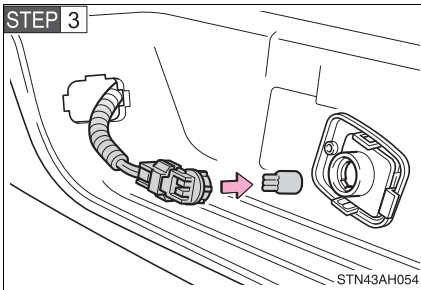

Remove the light bulb.

■ Lights other than the above

If any of the lights listed below has burnt out, have it replaced by your Toyota dealer.

- Outer foot light (if equipped)
 - Side turn signal light (if equipped)
-

■ Condensation build-up on the inside of the lens

Contact your Toyota dealer for more information in the following situations. Temporary condensation build-up on the inside of the headlight lens does not indicate a malfunction.

- Large drops of water are built up on the inside of the lens.
- Water has built up inside the headlight.

■ LED side turn signal lights

The side turn signal light consists of a number of LEDs. If any of the LEDs burn out, take your vehicle to your Toyota dealer to have the light replaced.

■ Installing the fender liner clips

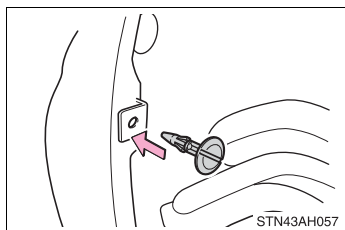

Insert the clip.

 **CAUTION****■ Replacing light bulbs**

- Turn off the headlights. Do not attempt to replace the bulb immediately after turning off the headlights.
The bulbs become very hot and may cause burns.
- Do not touch the glass portion of the light bulb with bare hands. Hold the bulb by the plastic or metal portion.
If the bulb is scratched or dropped it may blow out or crack.
- Fully install light bulbs and any parts used to secure them. Failing to do so may result in heat damage, fire, or water entering the headlight unit. This may damage the headlights or cause condensation to build up on the lens.

■ To prevent damage or fire

Make sure bulbs are fully seated and locked.

When trouble arises

5

5-1. Essential information

Emergency flashers	584
If your vehicle needs to be towed	585
If you think something is wrong	591
Fuel pump shut off system	592
Event data recorder	593

5-2. Steps to take in an emergency

If a warning light turns on or a warning buzzer sounds... ..	595
If a warning message is displayed (vehicles with multi-information display)	604
If you have a flat tire.....	608
If the engine will not start.....	625
If the shift lever cannot be shifted from P.....	627
If you lose your keys	630
If the vehicle battery is discharged	631
If your vehicle overheats	634
If the vehicle becomes stuck	637
If your vehicle has to be stopped in an emergency	638

5-1. Essential information

Emergency flashers

Use the emergency flashers if the vehicle malfunctions or is involved in an accident.

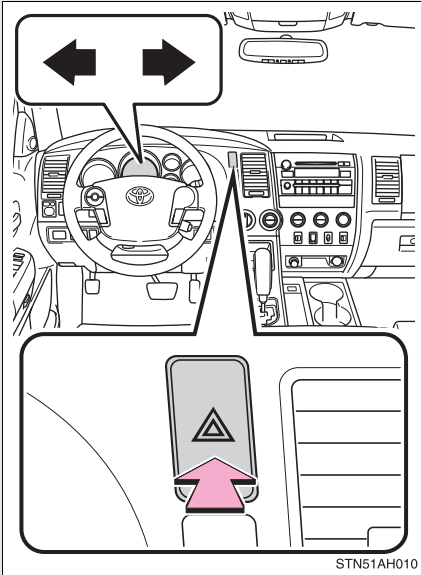

Press the switch to flash all the turn signal lights. To turn them off, press the switch once again.

NOTICE

To prevent battery discharge

Do not leave the emergency flashers on longer than necessary when the engine is not running.

If your vehicle needs to be towed

If towing is necessary, we recommend having your vehicle towed by your Toyota dealer or a commercial towing service, using a lift-type truck or a flat bed truck.

Use a safety chain system for all towing, and abide by all state/provincial and local laws.

The wheels and axle on the ground must be in good condition.

If they are damaged, use a towing dolly or flat bed truck.

Before towing

The following may indicate a problem with your transmission. Contact your Toyota dealer before towing.

- The engine is running, but the vehicle will not move.
- The vehicle makes an abnormal sound.

Emergency towing

If a tow truck is not available, in an emergency your vehicle may be temporarily towed using a cable or chain secured to the emergency towing eyelet. This should only be attempted on hard, surfaced roads for short distances at low speeds.

A driver must be in the vehicle to steer and operate the brakes. The vehicle's wheels, drive train, axles, steering and brakes must be in good condition.

► Type A

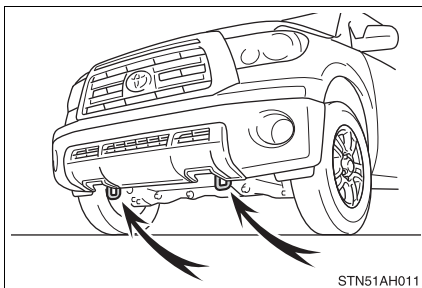

Towing eyelet

► Type B

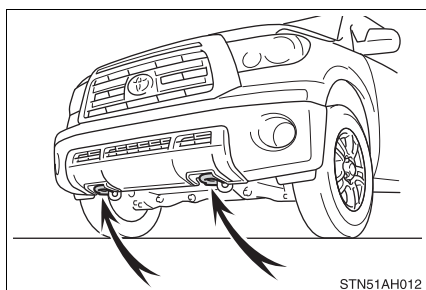

Towing eyelet

■ **Emergency towing procedure**

- STEP 1** The engine switch must be in the ACC (engine off) or the ON (engine running) position.
- STEP 2** 4WD models: Put the front wheel drive control switch in 2WD.
- STEP 3** Shift the shift lever to N.
- STEP 4** Release the parking brake.

⚠ CAUTION

■ **Caution while towing**

- Use extreme caution when towing the vehicle. Avoid sudden starts or erratic driving maneuvers which place excessive stress on the emergency towing eyelet and the cables or chains. Always use caution for the surroundings and other vehicles while towing.
- If the engine is not running, the power assist for the brakes and steering will not function, making steering and braking more difficult.

 NOTICE

■ **To prevent serious damage to the transmission**

Never tow this vehicle from the rear with the four wheels on the ground. This may cause serious damage to the transmission.

■ **Emergency towing eyelet precautions**

- Before emergency towing, check that the eyelet is not broken or damaged and that the installation bolts are not loose.
- Fasten the towing cable or chain securely to the eyelet.
- Do not jerk the eyelet. Apply steady and even force.
- To avoid damaging the eyelet, do not pull from the side or at a vertical angle. Always pull straight ahead.

Towing with a sling-type truck

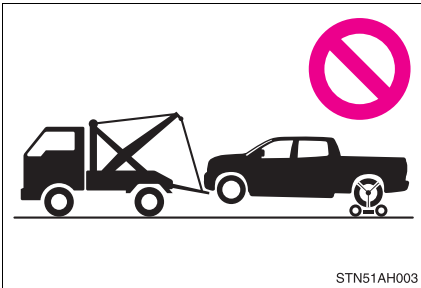
 NOTICE

■ **To prevent body damage**

Do not tow with a sling-type truck, either from the front or rear.

Towing with a wheel lift-type truck from the front

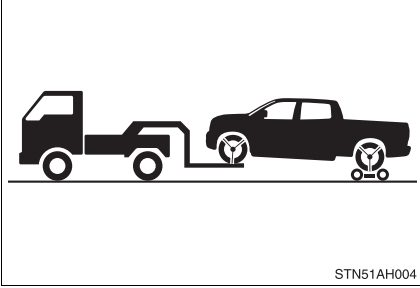

Use a towing dolly under the rear wheels.

NOTICE

To prevent serious damage to the transmission

Never tow this vehicle wheels on the ground.

Towing with a wheel lift-type truck from the rear

▶ 2WD models

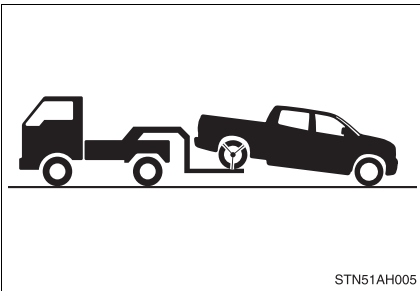

Turn the engine switch to the ACC position.

► 4WD models

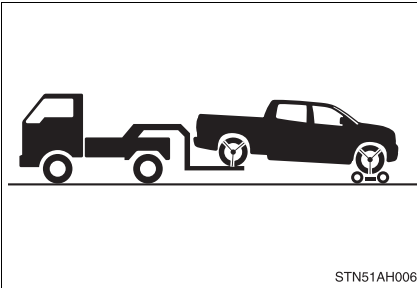

We recommend the use of a towing dolly under the front wheels.

When not using a towing dolly, turn the engine switch to the ACC position, shift the shift lever to N and put the front wheel drive control switch in 2WD.

⚠ NOTICE

■ To prevent damage to the vehicle

- Do not tow the vehicle with the key removed or in the LOCK position. The steering lock mechanism is not strong enough to hold the front wheel straight.
- When raising the vehicle, ensure adequate ground clearance for towing at the opposite end of the raised vehicle. Without adequate clearance, the vehicle could be damaged while being towed.

Using a flat bed truck

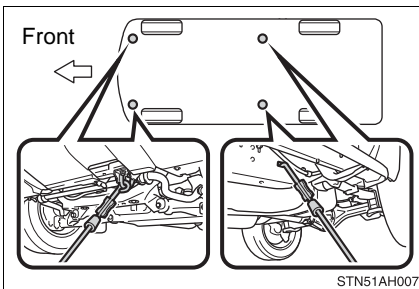

If your Toyota is transported by a flat bed truck, it should be tied down at the locations shown in the illustration.

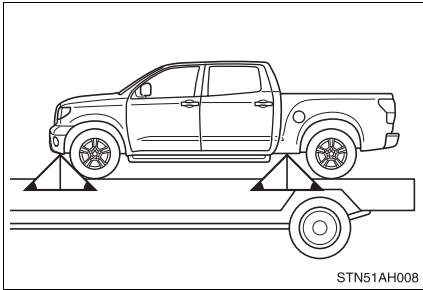

If you use chains or cables to tie down your vehicle, the angles indicated by triangles must be 45°.

Do not overly tighten the tie downs or the vehicle may be damaged.

Apply the parking brake firmly.

If you think something is wrong

If you notice any of the following symptoms, your vehicle probably needs adjustment or repair. Contact your Toyota dealer as soon as possible.

■ Visible symptoms

- Fluid leaks under the vehicle
(Water dripping from the air conditioning after use is normal.)
- Flat-looking tires or uneven tire wear
- Engine coolant temperature gauge needle continually points higher than normal
- Voltmeter continually points higher or lower than normal
(if equipped)
- Engine oil pressure gauge continually points lower than normal (if equipped)
- Automatic transmission fluid temperature gauge needle continually points higher than normal (if equipped)

■ Audible symptoms

- Changes in exhaust sound
- Excessive tire squeal when cornering
- Strange noises related to the suspension system
- Pinging or other noises related to the engine

■ Operational symptoms

- Engine missing, stumbling or running rough
- Appreciable loss of power
- Vehicle pulls heavily to one side when braking
- Vehicle pulls heavily to one side when driving on a level road
- Loss of brake effectiveness, spongy feeling, pedal almost touches the floor

Fuel pump shut off system

To minimize the risk of fuel leakage when the engine stalls or an air-bag inflates upon collision, the fuel pump shut off system stops supplying fuel to the engine.

Follow the procedure below to restart the engine after the system is activated.

STEP 1 Turn the engine switch to the ACC or LOCK position.

STEP 2 Restart the engine.



NOTICE

■ Before starting the engine

Inspect the ground under the vehicle.

If you find that fuel has leaked onto the ground, the fuel system has been damaged and is in need of repair. Do not restart the engine.

Your vehicle has computers that monitor and control certain aspects of your vehicle. These computers assist in driving and maintaining optimal vehicle performance.

Besides storing data useful for troubleshooting, there is an event data recorder (EDR) that records data in a crash or a near car crash event.

In a crash or a near car crash event

The SRS airbag sensor assembly contains the EDR. In a crash or a near car crash event, this device may record some or all of the following information:

- Engine speed
- Whether the brake pedal was applied or not
- Vehicle speed
- To what extent the accelerator pedal was depressed
- Position of the transmission shift lever
- Whether the driver and front passenger wore seat belts or not
- Driver's seat position
- SRS airbag deployment data
- SRS airbag system diagnostic data
- Front passenger's occupant classification

The information above is intended to be used for the purpose of improving vehicle safety performance. Unlike general data recorders, the EDR does not record sound data such as conversation between passengers.

Disclosure of the data

Toyota will not disclose the data recorded in an EDR to a third party except when:

- An agreement from the vehicle's owner (or the leasing company for a leased vehicle) is obtained
- Officially requested by the police or other authorities
- Used as a defense for Toyota in a law suit
- Ordered by a court of law

However, if necessary Toyota will:

- Use the data for research on Toyota vehicle safety performance
- Disclose the data to a third party for research purposes without disclosing details of the vehicle owner, and only when it is deemed necessary
- Disclose summarized data cleared of vehicle identification information to a non-Toyota organization for research purposes



5-2. Steps to take in an emergency

If a warning light turns on or a warning buzzer sounds...

Calmly perform the following actions if any of the warning lights turn on or flash. If a light turns on or flashes, but then turns off, this does not necessarily indicate a malfunction in the system.

Stop the vehicle immediately. Continuing to drive the vehicle may be dangerous.

The following warning indicates a possible problem in the brake system. Immediately stop the vehicle in a safe place and contact your Toyota dealer.

Warning light	Warning light/Details
 (U.S.A.)	Brake system warning light (warning buzzer)* <ul style="list-style-type: none">• Low brake fluid• Malfunction in the brake system This light also comes on when the parking brake is not released. If the light turns off after the parking brake is fully released, the system is operating normally.
 (Canada)	

*: Parking brake engaged warning buzzer:

The buzzer sounds to indicate that parking brake is still engaged (with the vehicle having reached a speed of 3 mph [5 km/h])

Stop the vehicle immediately.

The following warnings indicate the possibility of damage to the vehicle that may lead to an accident. Immediately stop the vehicle in a safe place and contact your Toyota dealer.

Warning light	Warning light/Details
	Charging system warning light Indicates a malfunction in the vehicle's charging system.



Warning light	Warning light/Details
<p style="text-align: center;">*1</p> 	<p>Low engine oil pressure warning light Indicates that the engine oil pressure is too low*2.</p>



*1: Vehicles without tachometer

*2: The light may come on when the oil level is extremely low. It is not designed to indicate low oil level, and the oil level must be checked using the engine oil level dipstick.

Have the vehicle inspected immediately.



Failing to investigate the cause of the following warnings may lead to the system operating abnormally and possibly cause an accident. Have the vehicle inspected by your Toyota dealer immediately.





Warning light	Warning light/Details
	<p>Malfunction indicator lamp Indicates a malfunction in:</p> <ul style="list-style-type: none"> • The electronic engine control system; • The electronic throttle control system; • The electronic automatic transmission control system; or • The emission control system.
	<p>SRS warning light Indicates a malfunction in:</p> <ul style="list-style-type: none"> • The SRS airbag system; • The front passenger occupant classification system; or • The seat belt pretensioner system.
<div style="display: flex; flex-direction: column; align-items: center;"> <div style="border: 1px solid black; padding: 5px; margin-bottom: 10px;"> <p>ABS</p> <p>(U.S.A.)</p> </div> <div style="border: 1px solid black; padding: 5px; margin-bottom: 10px;">  </div> <p>(Canada)</p> </div>	<p>ABS warning light Indicates a malfunction in:</p> <ul style="list-style-type: none"> • The ABS; or • The brake assist system.

Warning light	Warning light/Details
	<p>Slip indicator</p> <p>The indicator comes on to indicate a malfunction in:</p> <ul style="list-style-type: none"> • The VSC; • The TRAC; • The A-TRAC or • The AUTO LSD system.
	<p>Automatic transmission fluid temperature warning light</p> <p>Indicates that the automatic transmission fluid temperature is too high.</p>
 (if equipped)	<p>Power steering warning light</p> <p>Indicates a malfunction in the variable flow control power steering system.</p>

Follow the correction procedures.

After taking the specified steps to correct the suspected problem, check that the warning light turns off.

Warning light	Warning light/Details	Correction procedure
	<p>Open door warning light (warning buzzer)^{*1}</p> <p>Indicates that a door is not fully closed.</p>	Check that all doors are closed.
 (On the instrument cluster)	<p>Driver's seat belt reminder light (warning buzzer)^{*2}</p> <p>Warns the driver to fasten his/her seat belt.</p>	Fasten the seat belt.
 (On the center panel)	<p>Front passenger's seat belt reminder light (warning buzzer)^{*3}</p> <p>Warns the right front passenger to fasten his/her seat belt.</p>	Fasten the seat belt.

Warning light	Warning light/Details	Correction procedure
	<p>Tire pressure warning light</p> <ul style="list-style-type: none"> • When the light comes on: Low tire inflation pressure. • When the light comes on after blinking for 1 minute: Malfunction in the tire pressure warning system. 	<p>Adjust the tire inflation pressure.</p> <p>Have the system checked by your Toyota dealer.</p>
	<p>Low fuel level warning light</p> <p>Low level of fuel.</p>	<p>Refuel the vehicle.</p>
<p>*4</p> 	<p>Low washer fluid warning light</p> <p>Low level of washer fluid.</p>	<p>Fill the tank.</p>
<p>*4</p> 	<p>Engine oil replacement reminder light</p> <ul style="list-style-type: none"> • Illuminates for about 3 seconds and then flashes for about 12 seconds: Indicates that the engine oil is scheduled to be changed. • Comes on and remains: Indicates that the engine oil should be changed. 	<p>Check the engine oil, and change if necessary.</p> <p>Check and change the engine oil.</p>
<p>*5</p> 	<p>Master warning light</p> <p>A buzzer sounds and the warning light comes on and flashes to indicate that the master warning system has detected a malfunction.</p>	<p>→P. 604</p>

***1: Open door warning buzzer:**

The buzzer sounds to indicate that any door is opened (with the vehicle having reached a speed of 3 mph [5 km/h])

***2: Driver's seat belt reminder:**

The driver's seat belt reminder sounds to alert the driver that his or her seat belt is not fastened. Once the engine switch is turned to the ON or START position, the buzzer sounds for 6 seconds. If the vehicle has reached a speed of at least 12 mph (20 km/h), the buzzer sounds intermittently for 10 seconds. Then, if the seat belt is still unfastened, the buzzer will sound in a different tone for 20 more seconds.

***3: Front passenger's seat belt reminder:**

The front passenger's seat belt reminder sounds to alert the right front passenger that his or her seat belt is not fastened. The buzzer sounds intermittently for 10 seconds after the vehicle has reached a speed of at least 12 mph (20 km/h). Then, if the seat belt is still unfastened, the buzzer will sound in a different tone for 20 more seconds.

4: Vehicles without multi-information display**5: Vehicles with multi-information display****■ Four-wheel drive system warning buzzer**

The buzzer indicated that the transfer mode is not selected correctly.

■ Key reminder buzzer

The buzzer indicates that the key has not been removed (with the engine switch in the ACC or LOCK position and the driver's door opened).

■ Open moon roof reminder buzzer

The buzzer indicate that the moon roof is still opened (with the engine switch in the ACC or LOCK position and the driver's door opened).

■ If the malfunction indicator lamp comes on while driving

First check the following:

- Is your vehicle low on gas?
If it is, refuel the vehicle immediately.
- Is the fuel tank cap loose?
If it is, tighten it securely.

The light will go off after taking several driving trips.

If the light does not go off even after several trips, contact your Toyota dealer as soon as possible.

■ **Front passenger detection sensor and passenger seat belt reminder**

If luggage or other load is placed on the right front passenger seat, depending on its weight, the reminder light to flash and buzzer to sound.

■ **When the tire pressure warning light comes on**

Check the tire inflation pressure and adjust to the appropriate level.

Pushing the tire pressure warning reset switch does not turn off the tire pressure warning light.

■ **The tire pressure warning light may turn on due to natural causes**

The tire pressure warning light may turn on due to natural causes such as natural air leaks or tire inflation pressure changes caused by temperature. In this case, adjusting the tire inflation pressure will turn off the warning light (after several minutes).

■ **When a tire is replaced with a spare tire**

The temporary spare tire is not equipped with the tire pressure warning valve and transmitter. If a tire goes flat, the tire pressure warning light will not turn off even though the flat tire is replaced with the temporary spare tire. Replace the temporary spare tire with the repaired tire and adjust the proper tire inflation pressure. The tire pressure warning light will turn off after several minutes.

■ **If the tire pressure warning system is inoperative**

The tire pressure warning system will be disabled in the following conditions:

(When the condition becomes normal, the system will work properly.)

- If tires not equipped with tire pressure warning valves and transmitters are used.
- If the ID code on the tire pressure warning valves and transmitters is not registered in the tire pressure warning computer.

The tire pressure warning system may be disabled in the following conditions:

(When the condition becomes normal, the system will work properly.)

- If electronic devices or facilities using similar radio wave frequencies are nearby.

- If a radio set at similar frequencies is in use in the vehicle.
- If a window tint that affects the radio wave signals is installed.
- If there is a lot of snow or ice on the vehicle, in particular around the wheels or wheel housings.
- If non-genuine Toyota wheels are used. (Even if you use Toyota wheels, the tire pressure warning system may not work properly with some types of tires.)
- If tire chains are used.

■ **If the tire pressure warning light comes on after blinking for 1 minute frequently**

If the tire pressure warning light comes on after blinking for 1 minute frequently when the engine switch is turned to the ON position, have it checked by your Toyota dealer.

■ **After changing the engine oil (U.S.A. only)**

Make sure to reset the oil maintenance data. (→P. 532)

■ **Customization that can be configured at Toyota dealer**

The vehicle speed linked front passenger's seat belt reminder buzzer can be disabled. (Customizable features →P. 684)

 **CAUTION**

■ **If the tire pressure warning light comes on**

Be sure to observe the following precautions. Failure to do so could cause loss of vehicle control and result in death or serious injury.

- Stop your vehicle in a safe place as soon as possible. Adjust the tire inflation pressure immediately.
- If the tire pressure warning light comes on even after tire inflation pressure adjustment, it is probable that you have a flat tire. Check the tires. If the tire is flat, change to the spare tire and have the flat tire repaired by the nearest Toyota dealer.
- Avoid abrupt maneuvering and braking. If the vehicle tires deteriorate, you could lose control of the steering wheel or the brakes.

■ **If a blowout or sudden air leakage should occur**

The tire pressure warning system may not activate immediately.

 CAUTION

■ **Maintenance of the tire**

Each tire, including the spare (if provided), should be checked monthly when cold and inflated to the inflation pressure recommended by the vehicle manufacturer on the vehicle placard or tire inflation pressure label (tire and load information label). (If your vehicle has tires of a different size than the size indicated on the vehicle placard or tire inflation pressure label [tire and load information label], you should determine the proper tire inflation pressure for those tires.)

As an added safety feature, your vehicle has been equipped with a tire pressure monitoring system (TPMS-tire pressure warning system) that illuminates a low tire pressure telltale (tire pressure warning light) when one or more of your tires is significantly under-inflated. Accordingly, when the low tire pressure telltale (tire pressure warning light) illuminates, you should stop and check your tires as soon as possible, and inflate them to the proper pressure. Driving on a significantly under-inflated tire causes the tire to overheat and can lead to tire failure. Under-inflation also reduces fuel efficiency and tire tread life, and may affect the vehicle's handling and stopping ability.

Please note that the TPMS (tire pressure warning system) is not a substitute for proper tire maintenance, and it is the driver's responsibility to maintain correct tire pressure, even if under-inflation has not reached the level to trigger illumination of the TPMS low tire pressure telltale (tire pressure warning light).

Your vehicle has also been equipped with a TPMS (tire pressure warning system) malfunction indicator to indicate when the system is not operating properly. The TPMS (tire pressure warning system) malfunction indicator is combined with the low tire pressure telltale (tire pressure warning light). When the system detects a malfunction, the telltale will flash for approximately one minute and then remain continuously illuminated. This sequence will continue upon subsequent vehicle start-ups as long as the malfunction exists. When the malfunction indicator is illuminated, the system may not be able to detect or signal low tire pressure as intended.

 CAUTION

TPMS (tire pressure warning system) malfunctions may occur for a variety of reasons, including the installation of replacement or alternate tires or wheels on the vehicle that prevent the TPMS (tire pressure warning system) from functioning properly. Always check the TPMS (tire pressure warning system) malfunction telltale after replacing one or more tires or wheels on your vehicle to ensure that the replacement or alternate tires and wheels allow the TPMS (tire pressure warning system) to continue to function properly.

 NOTICE

■ **Precaution when installing a different tire**

When a tire of a different specification or maker is installed, the tire pressure warning system may not operate properly.

5-2. Steps to take in an emergency

If a warning message is displayed (vehicles with multi-information display)

If a warning is shown on the multi-information display, stay calm and perform the following actions:

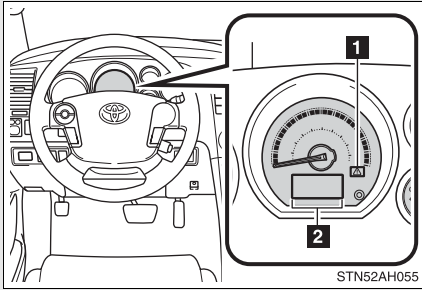

1 Master warning light



The master warning light also comes on or flashes in order to indicate that a message is currently being displayed on the multi-information display.

2 Multi-information display

If any of the warning lights turns on again after performing the following actions, contact your Toyota dealer.

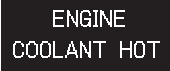

Stop the vehicle immediately.

The following warnings indicate the possibility of damage to the vehicle that may lead to an accident. Immediately stop the vehicle in a safe place and contact your Toyota dealer.



Warning message	Details
  (Flashing)	Indicates that the engine coolant temperature is too high A buzzer also sounds.
	Indicates that the automatic transmission fluid temperature is too high A buzzer also sounds and the automatic transmission fluid temperature warning light comes on.

Follow the correction procedures.

After taking the specified steps to correct the suspected problem, check that the warning light turns off.

Warning message	Details	Correction procedure
<p>DRIVER DOOR OPEN</p> <p>PASSENGER DOOR OPEN</p> <p>LEFT REAR DOOR OPEN</p> <p>RIGHT REAR DOOR OPEN</p>	<p>Indicates that one or more of the doors is not fully closed.</p> <p>The system also indicates which doors are not fully closed.</p> <p> flashes and a buzzer sounds to indicate that one or more of the doors is not fully closed (with the vehicle having reached a speed of 3 mph [5 km/h]). Open door warning light also comes on.</p>	<p>Make sure that all of the doors are closed.</p>
<p>PARKING BRAKE ENGAGED</p> <p> (Flashing)</p>	<p>Indicates that the parking brake is still engaged with the vehicle having reached a speed of more than 3 mph (5 km/h).</p> <p>A buzzer also sounds intermittently.</p>	<p>Release the parking brake.</p>
<p>LOW WASHER FLUID</p> <p></p>	<p>Indicates that the washer fluid level is low.</p> <p>A buzzer also sounds.</p>	<p>Add washer fluid.</p>

5-2. Steps to take in an emergency

Warning message	Details	Correction procedure
<p data-bbox="112 363 285 431">MAINT REQD SOON</p>  <p data-bbox="123 532 267 558">(U.S.A. only)</p>	<p data-bbox="343 256 642 347">Indicates that the engine oil is scheduled to be changed.</p> <p data-bbox="359 354 610 380">A buzzer also sounds.</p> <p data-bbox="343 402 638 656">Comes on approximately 4500 miles (7200 km) after the engine oil is changed. (The indicator will not work properly unless the oil maintenance data has been reset).</p>	<p data-bbox="682 409 919 500">Check the engine oil, and change if necessary.</p>
<p data-bbox="112 753 285 821">MAINT REQD</p>  <p data-bbox="123 915 267 941">(U.S.A. only)</p>	<p data-bbox="343 695 642 753">Indicates that the engine oil should be changed.</p> <p data-bbox="359 760 610 786">A buzzer also sounds.</p> <p data-bbox="343 824 638 1013">Comes on approximately 5000 miles (8000 km) after the engine oil is changed (and the oil maintenance data has been reset).</p>	<p data-bbox="682 815 937 873">Check and change the engine oil.</p>
<p data-bbox="112 1071 285 1140">LOW FUEL LEVEL</p>	<p data-bbox="343 1036 607 1094">Indicates that the fuel level is low.</p> <p data-bbox="359 1101 628 1192">A buzzer also sounds and the low fuel level warning light comes on.</p>	<p data-bbox="682 1078 940 1136">Fill up the tank as soon as possible.</p>

■ **After changing the engine oil (U.S.A. only)**

Make sure to reset the oil maintenance data. (→P. 532)

5-2. Steps to take in an emergency If you have a flat tire

Remove the flat tire and replace it with the spare provided.

■ Before jacking up the vehicle

- Stop the vehicle on a hard, flat surface.
- Set the parking brake.
- Shift the shift lever to P.
- Stop the engine.
- Turn on the emergency flashers.

■ Location of the spare tire

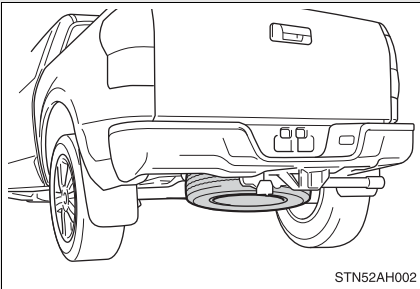

■ Location of the jack and tools

► Regular Cab models

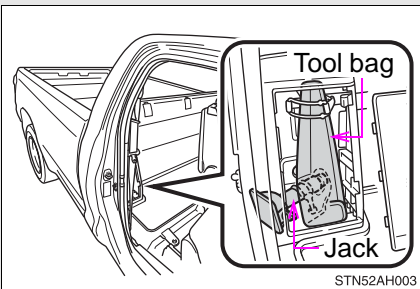

► Double Cab models without storage box

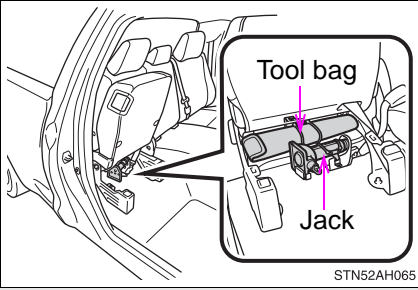

► Double Cab models with storage box

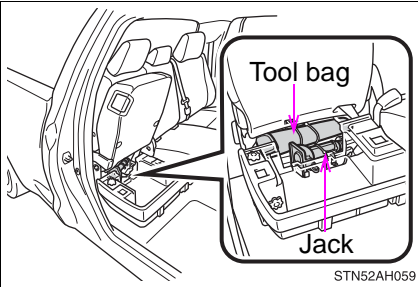

► CrewMax models

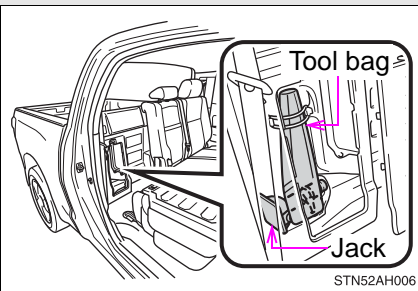

Taking out the jack and tool bag (Regular Cab models)

STEP 1

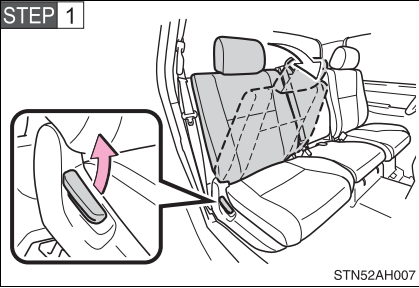

Pull the lever and fold down the seatback.

STEP 2

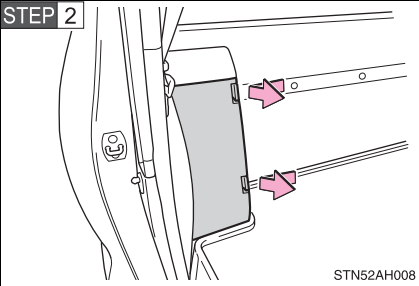

Remove the cover.

STEP 3

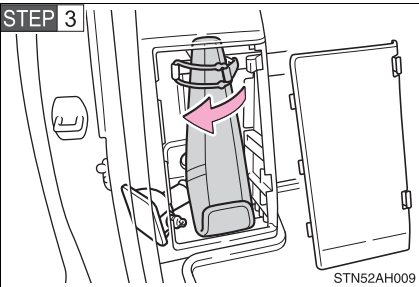

Unhook the strap and remove the tool bag.

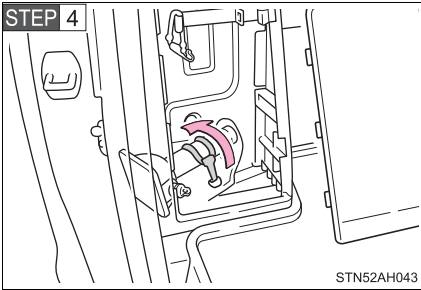

Unhook the strap.

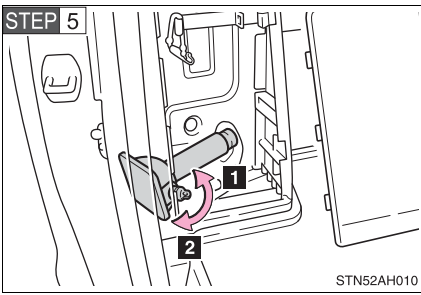

Loosen and remove the jack.

Taking out the jack and tool bag (Double Cab models)

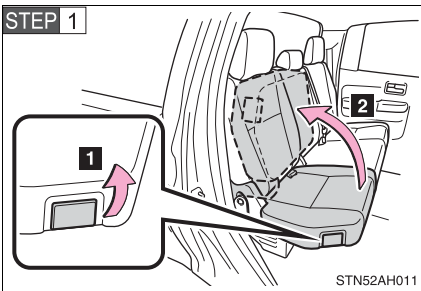

1 Pull up the lever.
2 Raise the bottom cushion up.

5-2. Steps to take in an emergency

► Vehicles with storage box

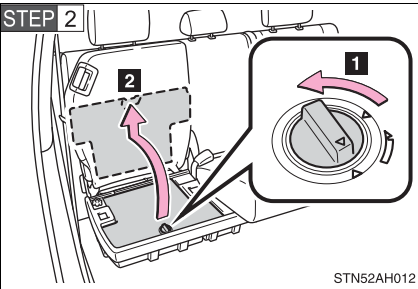

1 Turn the knob to the OPEN direction.

2 Remove the lid.

► Vehicles with storage box

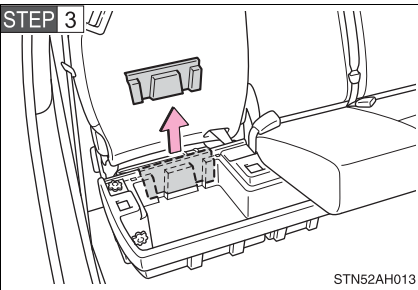

Remove the jack cover panel.

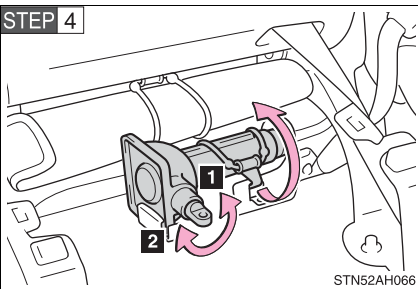

Unhook the strap. Loosen and remove the jack.

1 Loosen

2 Tighten

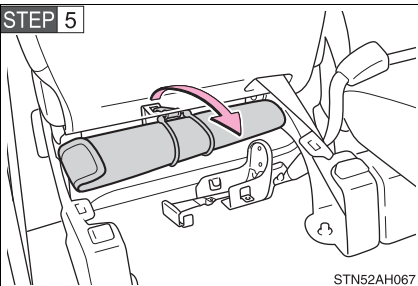

Unhook the strap and remove the tool bag.

Taking out the jack and tool bag (CrewMax models)

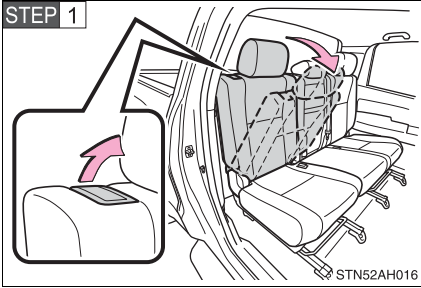

Pull the lever and fold down the seatback.

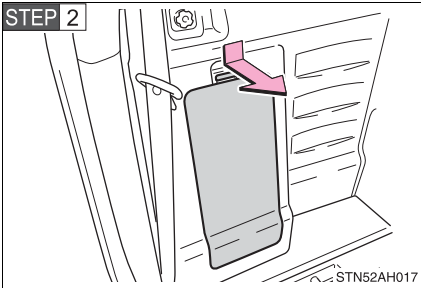

Remove the cover.

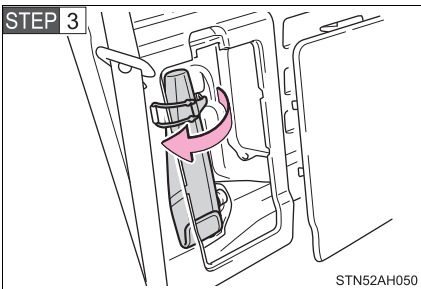

Unhook the strap and remove the tool bag.

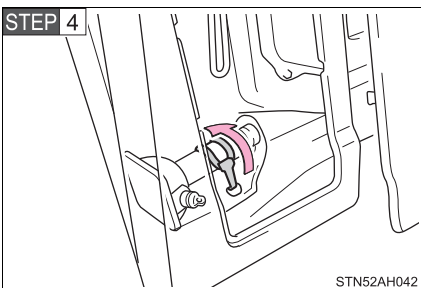

Unhook the strap.

5-2. Steps to take in an emergency

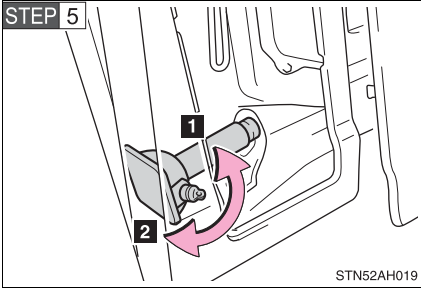

Loosen and remove the jack.

- 1 Loosen
- 2 Tighten

Assemble the jack handle (in the tool bag)

► Type A

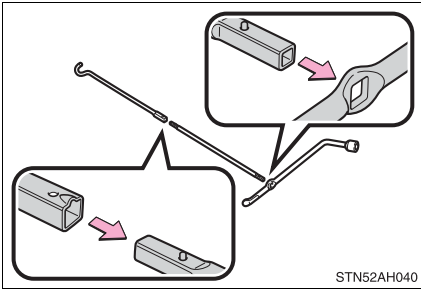

Assemble the jack handle extension as shown.

► Type B

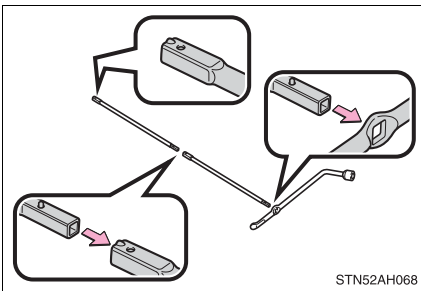

Taking out the spare tire

► Type A

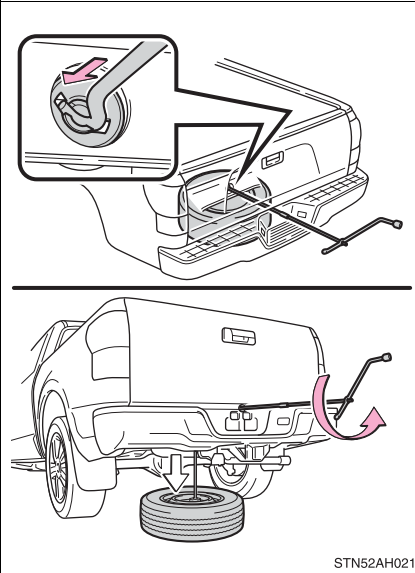

Insert the end of the jack handle extension into the lowering screw and turn it counterclockwise.

After the tire is lowered completely to the ground, remove the holding bracket.

► Type B

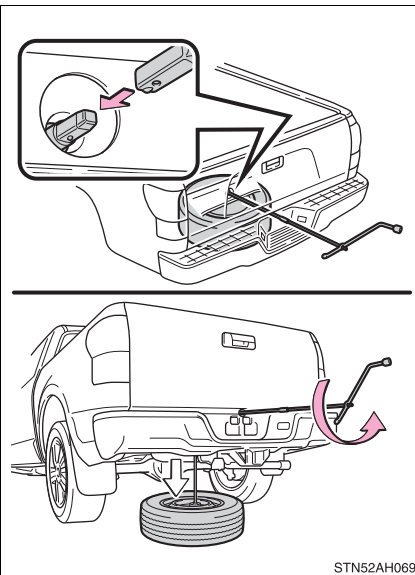

Replacing a flat tire

STEP 1

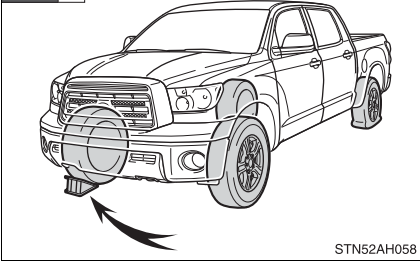

Chock the tires.

Flat tire		Wheel chock positions
Front	Left-hand side	Behind the rear right-hand side tire
	Right-hand side	Behind the rear left-hand side tire
Rear	Left-hand side	In front of the front right-hand side tire
	Right-hand side	In front of the front left-hand side tire

STEP 2

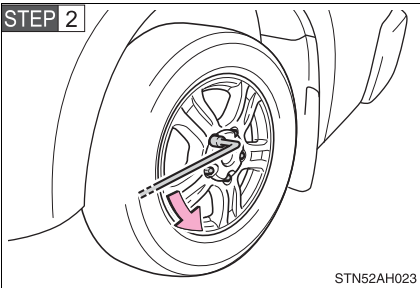

Slightly loosen the wheel nuts (one turn).

► Type A

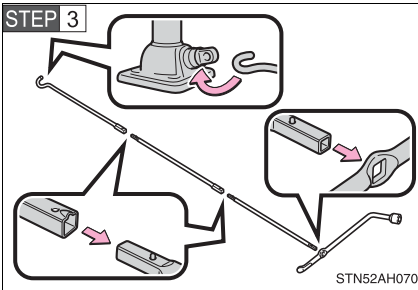

Assemble the jack handle extension as shown.

► Type B

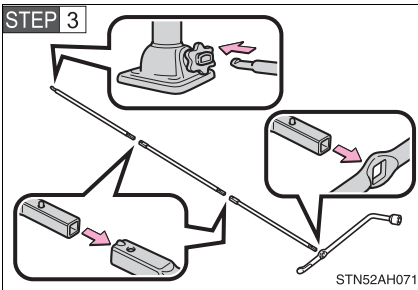

STEP 4

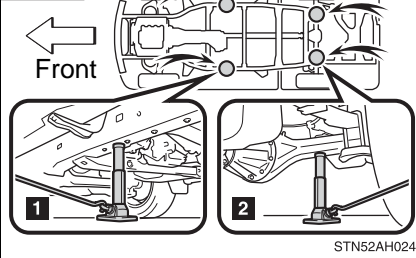

Position the jack at the correct jack point as shown.

- 1 Front
- 2 Rear

Make sure the jack is positioned on a level and solid place.

STEP 5

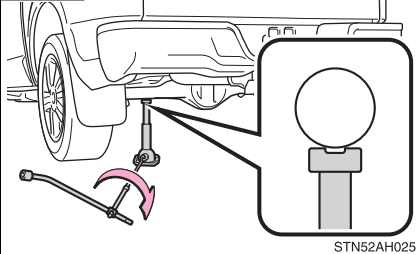

Raise the vehicle until the tire is slightly raised off the ground.

When positioning the jack under the rear axle housing, make sure the groove on the top of the jack fits with the rear axle housing.

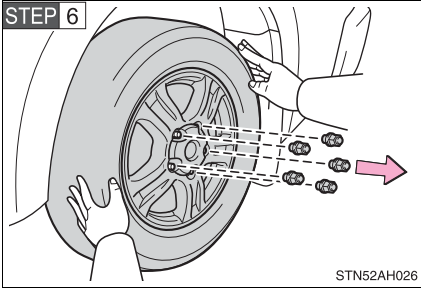

Remove all the wheel nuts and the tire.

When resting the tire on the ground, place the tire so that the wheel design faces up to avoid scratching the wheel surface.

Installing the tire

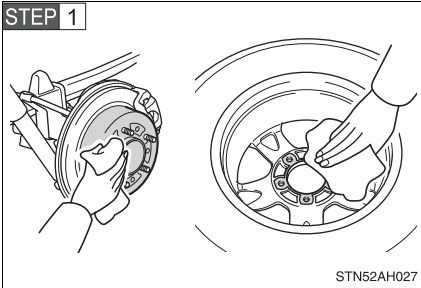

Remove any dirt or foreign matter from the wheel contact surface.

If foreign matter is on the wheel contact surface, the wheel nuts may loosen while the vehicle is in motion, and the tire may come off the vehicle.

STEP 2 Install the tire and loosely tighten each wheel nut by hand by approximately the same amount.

► Replacing a steel wheel with a steel wheel

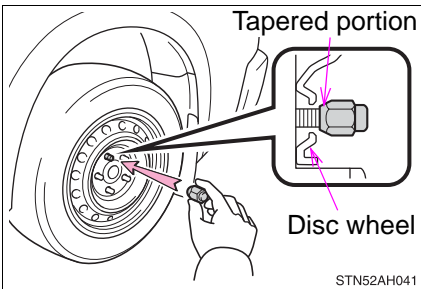

Tighten the nuts until the tapered portion comes into loose contact with the bolt seat in the disc wheel.

► Replacing an aluminum wheel with a steel wheel

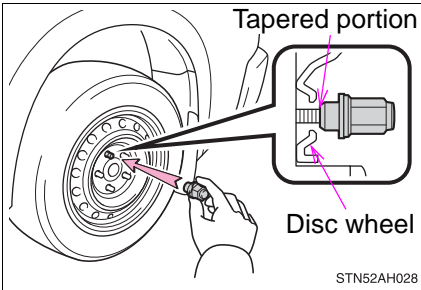

Tighten the nuts until the tapered portion comes into loose contact with the bolt seat in the disc wheel.

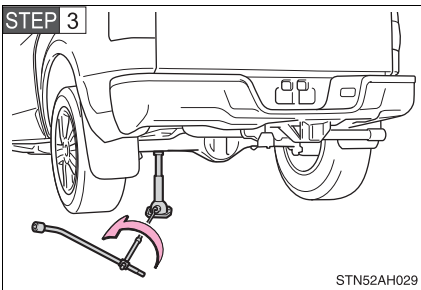

Lower the vehicle.

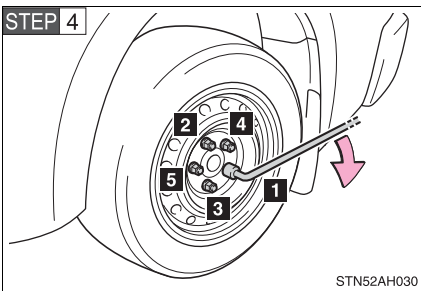

Firmly tighten each nut two or three times in the order shown in the illustration.

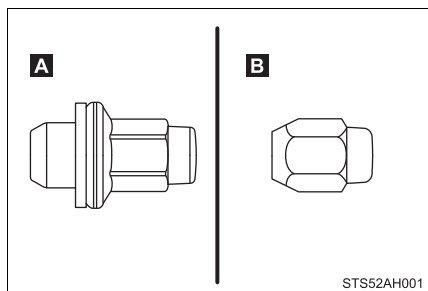

Tightening torque

- A** Flat washer type (Aluminum wheels)
97 ft·lbf (131 N·m, 13.4 kgf·m)*
- B** Taper type (Steel wheels)
154 ft·lbf (209 N·m, 21.3 kgf·m)

*: When temporarily used on spare tire/wheel, apply 154 ft·lbf (209 N·m, 21.3 kgf·m)

Stowing the flat tire, jack and all tools

STEP 1 Remove the center wheel ornament by pushing from the reverse side.

STEP 2 Lay down the tire with the outer side facing up, and install the holding bracket.

Then secure the tire, taking care that the tire goes straight up without catching on any other part, to prevent it from flying forward during a collision or sudden braking.

Keep winding until three clicks are heard.

STEP 3 Stow the tools and jack securely.

■ After completing the tire change

The tire pressure warning system must be reset. (→P. 543)

■ When using the temporary spare tire

As the temporary spare tire is not equipped with the tire pressure warning valve and transmitter, low inflation pressure of the spare tire will not be warned. Also, if you replace the temporary spare tire after the tire pressure warning light comes on, the light remains on.

 **CAUTION****■ Using the jack**

Improper use of the jack may lead to death or serious injuries due to the vehicle suddenly falling off the jack.

- Do not use the jack for any purpose other than replacing tires or installing and removing tire chains.
- Only use the jack that comes with this vehicle for replacing a flat tire. Do not use it on other vehicles, and do not use other jacks for replacing tires on this vehicle.
- Always check that the jack is securely set to the jack point.
- Do not put any part of your body under the vehicle supported by a jack.
- Do not start or run the engine while your vehicle is supported by the jack.
- Do not raise the vehicle while someone is in it.
- When raising the vehicle, do not put an object on or under the jack.
- Do not raise the vehicle to a height greater than that required to replace the tire.
- Use a jack stand if it is necessary to get under the vehicle.

Take particular care when lowering the vehicle to ensure that no one working on or near the vehicle will be injured.

■ Using the jack handle

Insert the square head securely until you hear a click to prevent the extension parts from coming apart unexpectedly.

■ Replacing a flat tire

Observe the following precautions to reduce the risk of death or serious injury.

- Retighten the wheel nuts within 100 miles (160 km) of driving. Otherwise, the nuts may loosen and the wheels may fall off, which could cause a serious accident.
- Lower the spare tire completely to the ground before removing it from under the vehicle.

 **CAUTION**

■ **Replacing a flat tire**

- Do not try to remove the wheel ornament by hand. Take due care in handling the ornament to avoid unexpected personal injury.
- Never use oil or grease on the wheel bolts or wheel nuts.
Oil and grease may cause the wheel nuts to be excessively tightened, leading to bolt or disc wheel damage. In addition, the oil or grease can cause the wheel nuts to loosen and the wheel may fall off, causing a serious accident. Remove any oil or grease from the wheel bolts or wheel nuts.
- Have the wheel nuts tightened with a torque wrench as soon as possible after changing wheels.
Steel wheel: 154 ft·lbf (209 N·m, 21.3 kgf·m)
Aluminum wheel: 97 ft·lbf (131 N·m, 13.4 kgf·m)
Failure to follow these precautions could cause the nuts to loosen and the wheels may fall off, which could lead to an accident causing death or serious injury.
- Do not attach a heavily damaged wheel ornament, as it may fly off the wheel while the vehicle is moving.

■ **When using the temporary spare tire**

- Remember that your temporary spare tire is specifically designed for use with your vehicle. Do not use your temporary spare tire on another vehicle.
- Do not use two temporary spare tires simultaneously.
- Replace the temporary spare tire with a standard tire as soon as possible.
- Avoid sudden acceleration, deceleration and braking, as well as sharp cornering.

■ **Speed limit when using the temporary spare tire**

Do not drive at speeds in excess of 50 mph (80 km/h) when a temporary spare tire is installed on the vehicle.

The temporary spare tire is not designed for driving at high speeds. Failing to observe this precaution may lead to an accident causing death or serious injury.

 CAUTION**■ Driving with tire chains and the temporary spare tire**

Do not fit tire chains to the temporary spare tire.

Tire chains may damage the vehicle body and adversely affect driving performance.

■ When the spare tire is attached

The vehicle speed may not be correctly detected, and the following systems may not operate correctly:

- ABS & Brake assist
- VSC
- TRAC
- A-TRAC
- AUTO LSD
- Cruise control
- Navigation system

Also, not only can the following system not be utilized fully, it may actually negatively effect the drive-train components:

- 4WD system

 NOTICE

■ **Do not drive the vehicle with a flat tire.**

Do not continue driving with a flat tire.

Driving even a short distance with a flat tire can damage the tire and the wheel beyond repair.

■ **When replacing the tires**

● When removing or fitting the wheels, tires or the tire pressure warning valve and transmitter, contact your Toyota dealer as the tire pressure warning valve and transmitter may be damaged if not handled correctly.

● Replace the grommets for the tire pressure warning valves and transmitters as well.

■ **To avoid damaging the tire pressure warning valves and transmitters**

Do not use liquid sealants on flat tires.

5-2. Steps to take in an emergency If the engine will not start

If the engine still does not start after following the correct starting procedure (→P. 183) or releasing the steering lock (→P. 184), confirm the following points.

■ **The engine will not start even when the starter motor operates normally.**

One of the following may be the cause of the problem.

- There may not be sufficient fuel in the vehicle's tank.
Refuel the vehicle. (→P. 109)

Flex-fuel vehicles: The type of fuel may be different. When refueling, add the same type of fuel, if available.

After adding a different type of fuel, the engine may run roughly and driving performance may be reduced for a while when the engine is first started. In this case, wait until the engine runs normally.

- The engine may be flooded.
Try to restart the engine once more following correct starting procedures.
- There may be a malfunction in the engine immobilizer system.
(→P. 114)

■ **The starter motor turns over slowly, the interior lights and headlights are dim, or the horn does not sound or sounds at a low volume.**

One of the following may be the cause of the problem.

- The battery may be discharged. (→P. 631)
- The battery terminal connections may be loose or corroded.

■ **The starter motor does not turn over, the interior lights and headlights do not turn on, or the horn does not sound.**

One of the following may be the cause of the problem.

- One or both of the battery terminals may be disconnected.
- The battery may be discharged. (→P. 631)

Contact your Toyota dealer if the problem cannot be repaired, or if repair procedures are unknown.

5-2. Steps to take in an emergency

If the shift lever cannot be shifted from P

If the shift lever cannot be shifted with your foot on the brake, there may be a problem with the shift lock system (a system to prevent accidental operation of the shift lever). Have the vehicle inspected by your Toyota dealer immediately.

The following steps may be used as an emergency measure to ensure that the shift lever can be shifted.

STEP 1 Set the parking brake.

STEP 2 Turn the engine switch to the ACC or ON position.

STEP 3 Depress the brake pedal.

STEP 4 Pry the cover up with a flathead screwdriver or equivalent.

► Floor shift type

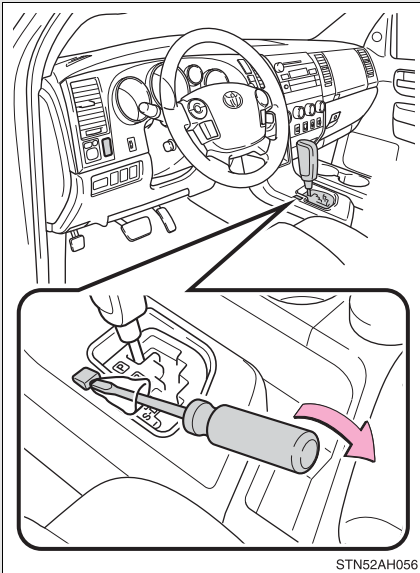

► Column-shift type

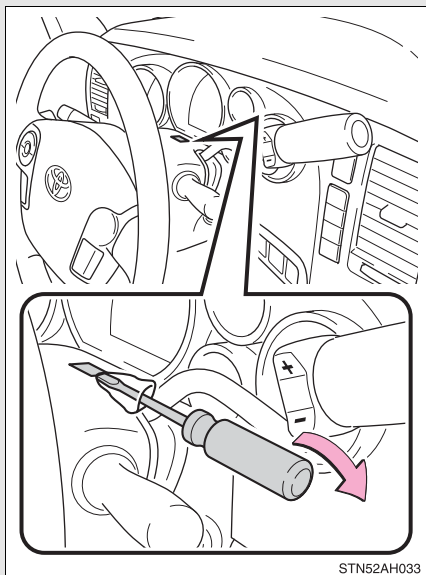

STEP 5 Press the shift lock override button.

The shift lever can be shifted while the button is pressed.

► Floor shift type

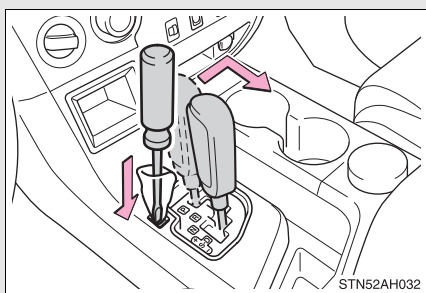

► Column-shift type

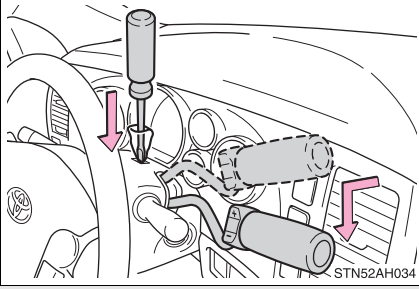

If you lose your keys

New genuine Toyota keys can be made by your Toyota dealer using the key number stamped on your key number plate. Vehicles with engine immobilizer system, the dealer will also need the master key. (→P. 42)

■ If you lose all your master keys. (vehicles with engine immobilizer system)

You cannot make new keys; the whole engine immobilizer system must be replaced.

5-2. Steps to take in an emergency If the vehicle battery is discharged

The following procedures may be used to start the engine if the vehicle's battery is discharged.

You can call your Toyota dealer or qualified repair shop.

If you have a set of jumper (or booster) cables and a second vehicle with a 12-volt battery, you can jump start your Toyota following the steps below.

STEP 1 Connect the jumper cables.

► 4.0 L V6 (1GR-FE) engine

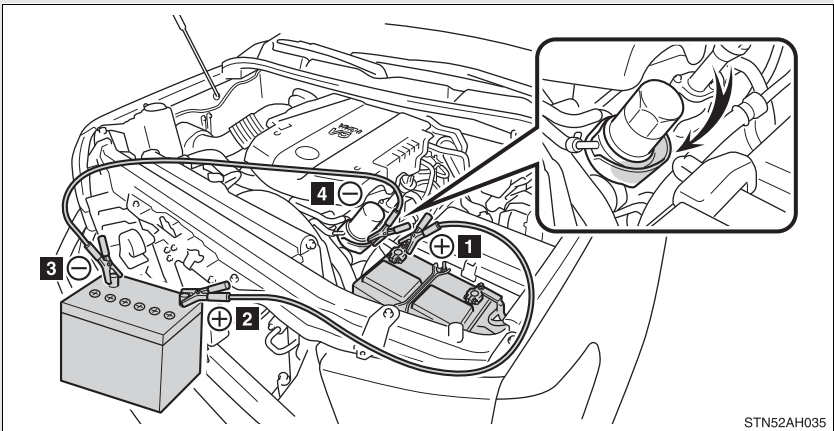

► 4.6 L V8 (1UR-FE) and 5.7 L V8 (3UR-FE, 3UR-FBE) engines

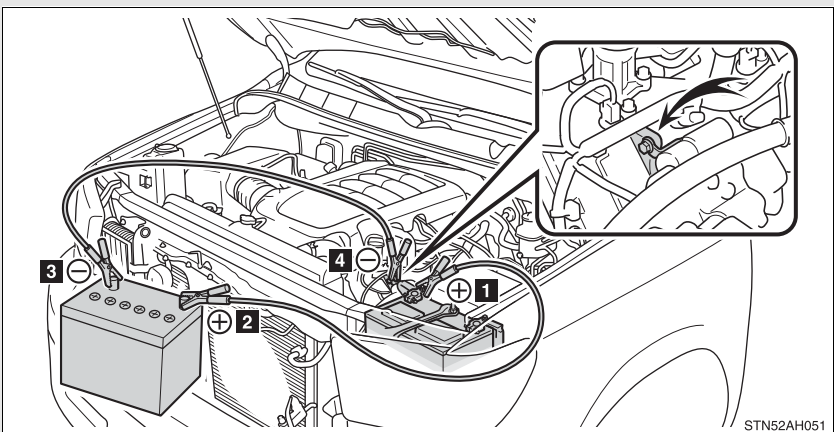

- 1** Positive (+) battery terminal on your vehicle
 - 2** Positive (+) battery terminal on the second vehicle
 - 3** Negative (-) battery terminal on the second vehicle
 - 4** Connect the jumper cable to ground on your vehicle as shown in the illustration.
- STEP 2** Start the engine of the second vehicle. Increase the engine speed slightly and maintain at that level for approximately 5 minutes to recharge the battery of your vehicle.
- STEP 3** Maintain the engine speed of the second vehicle and start the vehicle's engine.
- STEP 4** Once the vehicle's engine has started, remove the jumper cables in the exact reverse order in which they were connected.

Once the engine starts, have the vehicle checked at your Toyota dealer as soon as possible.

■ Starting the engine when the battery is discharged

The engine cannot be started by push-starting.

■ Avoiding a discharged battery

- Turn off the headlights and the audio system while the engine is turned off.
- Turn off any unnecessary electrical components when the vehicle is running at a low speed for an extended period, such as in heavy traffic, etc.

■ When the battery is removed or discharged

- The moon roof must be initialized. (→P. 106)
- Flex-fuel vehicles: The information recorded in the computer will be cleared, which may cause the engine to run roughly and reduce driving performance for a while when the engine is first started. In this case, wait until the engine runs normally.

If the vehicle is running on E85, the engine may stall.

In this case, restart the engine, repeatedly if necessary.

 **CAUTION****■ Avoiding battery fires or explosions**

Observe the following precautions to prevent accidentally igniting the flammable gas that may be emitted from the battery.

- Make sure the jumper cable is connected to the correct terminal and that it is not unintentionally in contact with any part other than the intended terminal.
- Do not allow a jumper cable to come into contact with both “+” and “-” terminals.
- Do not smoke, use matches, cigarette lighters or allow open flame near the battery.

■ Battery precautions

The battery contains poisonous and corrosive acidic electrolyte, while related parts contain lead and lead compounds. Observe the following precautions when handling the battery.

- When working with the battery, always wear safety glasses and take care not to allow any battery fluids (acid) to come into contact with skin, clothing or the vehicle body.
- Do not lean over the battery.
- In the event that battery fluid comes into contact with the skin or eyes, immediately wash the affected area with water and seek medical attention. Place a wet sponge or cloth over the affected area until medical attention can be received.
- Always wash your hands after handling the battery support, terminals, and other battery-related parts.
- Do not allow children near the battery.

 **NOTICE****■ When handling jumper cables**

Be careful that the jumper cables do not become tangled in the cooling fan or any of the belts when connecting or disconnecting them.

5-2. Steps to take in an emergency If your vehicle overheats

If your engine overheats:

STEP 1 Stop the vehicle in a safe place and turn off the air conditioning system.

STEP 2 Check to see if steam is coming out from under the hood.

If you see steam:

Stop the engine. Carefully lift the hood after the steam subsides and then restart the engine.

If you do not see steam:

Leave the engine running and carefully lift the hood.

STEP 3 Check to see if the cooling fan is operating.

If the fan is operating:

Wait until the temperature of the engine (shown on the instrument cluster) begins to fall and then stop the engine.

If the fan is not operating:

Stop the engine immediately and call your local Toyota dealer.

STEP 4

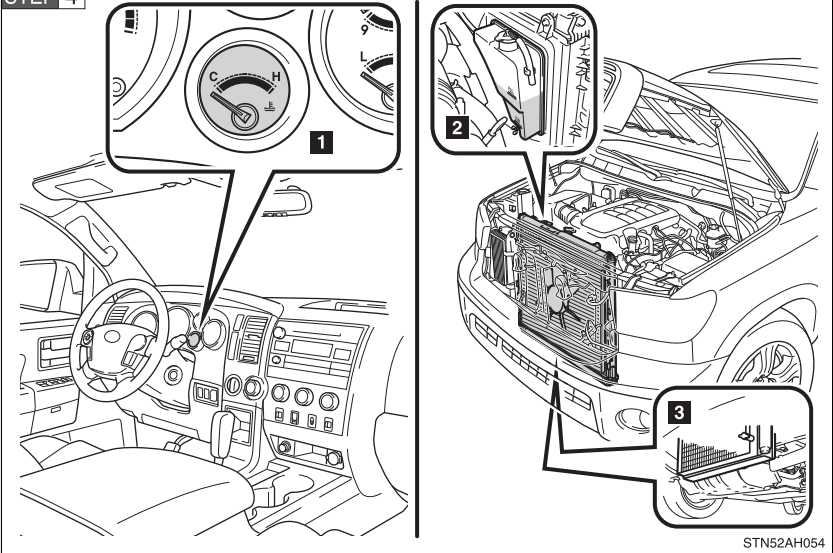

- 1** The engine has cooled down sufficiently.

The engine coolant temperature gauge indicates C.

- 2** Check the engine coolant level.

- 3** Look for obvious coolant leaks from the radiator, hoses and under the vehicle.

Note that water draining from the air conditioning is normal if it has been used.

STEP 5

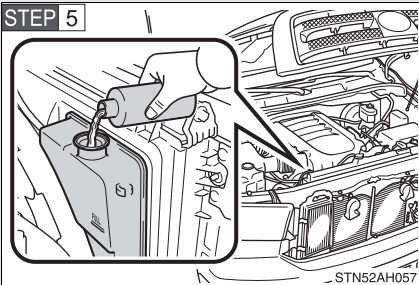

Add engine coolant if required.

Water can be used in an emergency if engine coolant is unavailable. (→P. 661)

Have the vehicle checked at your nearest Toyota dealer as soon as possible.

■ Overheating

If you observe the following, your vehicle may be overheating.

- The engine coolant temperature gauge enters the red zone or a loss of power is experienced.
- Steam is coming from under the hood.
- “ENGINE COOLANT HOT” is shown on the multi-information display (vehicles with multi-information display).

CAUTION

■ To prevent an accident or injury when inspecting under the hood of your vehicle

- If steam is seen coming from under the hood, do not open the hood until the steam has subsided. The engine compartment may be very hot, causing serious injury such as burns.
- Keep hands and clothing away from the fan and other belts while the engine is running.
- Do not loosen the radiator cap while the engine and radiator are hot. Serious injury, such as burns, may result from hot coolant and steam released under pressure.

NOTICE

■ When adding engine coolant

Wait until the engine has cooled down before adding engine coolant. When adding coolant, do so slowly. Adding cool coolant to a hot engine too quickly can cause damage to the engine.

5-2. Steps to take in an emergency If the vehicle becomes stuck

Carry out the following procedures if the tires spin or the vehicle becomes stuck in mud, dirt, or snow.

- STEP 1** Stop the engine. Set the parking brake and put the shift lever in P.
- STEP 2** Remove the mud, snow, or sand from around the stuck tire.
- STEP 3** Place wood, stones or some other material to help provide traction under the tires.
- STEP 4** Restart the engine.
- STEP 5** Turn off the VSC (→P. 240, 245, 246, 247)
- STEP 6** Shift the shift lever to D or R and carefully apply the accelerator to free the vehicle.

CAUTION

■ **When attempting to free a stuck vehicle**

If you choose to rock the vehicle back and forth to free it, make sure the surrounding area is clear, to avoid striking other vehicles, objects or persons. The vehicle may also lunge forward or lunge back suddenly as it becomes free. Use extreme caution.

■ **When shifting the shift lever**

Be careful not to shift the shift lever with the accelerator pedal depressed. This may lead to unexpected rapid acceleration of the vehicle that may cause an accident and result in death or serious injury.

NOTICE

■ **To avoid damaging the transmission and other components**

- Avoid spinning the wheels and do not rev the engine.
- If the vehicle remains stuck after trying these procedures, the vehicle may require towing to be freed.

5-2. Steps to take in an emergency

If your vehicle has to be stopped in an emergency

Only in an emergency, such as if it becomes impossible to stop the vehicle in the normal way, stop the vehicle using the following procedure:

STEP 1 Steadily step on the brake pedal with both feet and firmly depress it.

Do not pump the brake pedal repeatedly as this will increase the effort required to slow the vehicle.

STEP 2 Shift the shift lever to N.

► If the shift lever is shifted to N

STEP 3 After slowing down, stop the vehicle in a safe place by the road.

STEP 4 Stop the engine.

► If the shift lever cannot be shifted to N

STEP 3 Keep depressing the brake pedal with both feet to reduce vehicle speed as much as possible.

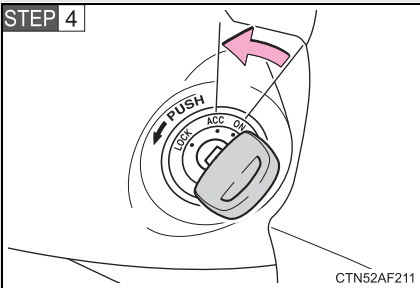

Stop the engine by turning the engine switch to the ACC position.

STEP 5 Stop the vehicle in a safe place by the road.

⚠ CAUTION

■ If the engine has to be turned off while driving

- Power assist for the brakes and steering wheel will be lost, making the brake pedal harder to depress and the steering wheel heavier to turn. Decelerate as much as possible before turning off the engine.
- Never attempt to remove the key, as doing so will lock the steering wheel.

6-1. Specifications

Maintenance data
(fuel, oil level, etc.) 640
Fuel information 669
Tire information 673

6-2. Customization

Customizable features 684
Items to initialize 687

6-1. Specifications

Maintenance data (fuel, oil level, etc.)

Dimensions

► 2WD models

Cab type	Regular Cab		Double Cab	
	Standard	Long	Standard	Long
Overall length	210.2 in. (5340 mm)	229.1 in. (5820 mm)		248.0 in. (6300 mm)
Overall width	79.9 in. (2030 mm)			
Overall height* ¹	75.9 in. (1930 mm) ^{*2}	75.7 in. (1925 mm) ^{*2}	75.9 in. (1930 mm) ^{*2}	75.7 in. (1925 mm) ^{*2}
	75.7 in. (1925 mm) ^{*3,*4}	75.5 in. (1920 mm) ^{*3}	75.7 in. (1925 mm) ^{*3,*4}	75.5 in. (1920 mm) ^{*3}
Wheelbase	126.7 in. (3220 mm)	145.6 in. (3700 mm)		164.5 in. (4180 mm)
Front tread	67.9 in. (1725 mm)			
Rear tread	67.9 in. (1725 mm)			

*1: Unladen vehicle

*2: P255/70R18 tires

*3: P275/65R18 tires

*4: P275/55R20 tires

Cab type	CrewMax
Bed type	Short
Overall length	229.1 in. (5820 mm)
Overall width	79.9 in. (2030 mm)
Overall height ^{*1}	75.7 in. (1925 mm) ^{*2}
	75.5 in. (1920 mm) ^{*3,*4}
Wheelbase	145.6 in. (3700 mm)
Front tread	67.9 in. (1725 mm)
Rear tread	67.9 in. (1725 mm)

*1: Unladen vehicle

*2: P255/70R18 tires

*3: P275/65R18 tires

*4: P275/55R20 tires

► 4WD models

Cab type	Regular Cab		Double Cab	
Bed type	Standard	Long	Standard	Long
Overall length	210.2 in. (5340 mm)	229.1 in. (5820 mm)		248.0 in. (6300 mm)
Overall width	79.9 in. (2030 mm)			
Overall height ^{*1}	76.3 in. (1940 mm) ^{*2}	76.1 in. (1935 mm) ^{*2}	76.3 in. (1940 mm) ^{*2}	76.1 in. (1935 mm) ^{*2}
	76.1 in. (1935 mm) ^{*3,*4}	75.9 in. (1930 mm) ^{*3}	76.1 in. (1935 mm) ^{*3,*4}	75.9 in. (1930 mm) ^{*3}
Wheelbase	126.7 in. (3220 mm)	145.6 in. (3700 mm)		164.5 in. (4180 mm)
Front tread	67.9 in. (1725 mm)			
Rear tread	67.9 in. (1725 mm)			

*1: Unladen vehicle

*2: P255/70R18 tires

*3: P275/65R18 tires

*4: P275/55R20 tires

Cab type	CrewMax
Bed type	Short
Overall length	229.1 in. (5820 mm)
Overall width	79.9 in. (2030 mm)
Overall height ^{*1}	76.1 in. (1935 mm) ^{*2}
	75.9 in. (1930 mm) ^{*3,*4}
Wheelbase	145.6 in. (3700 mm)
Front tread	67.9 in. (1725 mm)
Rear tread	67.9 in. (1725 mm)

*1: Unladen vehicle

*2: P255/70R18 tires

*3: P275/65R18 tires

*4: P275/55R20 tires

Vehicle capacity weight

► Regular Cab models

Model code*1	Engine	Driving system	Bed type	Vehicle capacity weight (Occupants+luggage)
GSK50L-TRADKA	4.0 L V6 (1GR-FE) engine	2WD	Standard	1485 lb. (670 kg)
GSK51L-THADKA			Long	1580 lb. (715 kg)
UPK50L-TRTDKA	4.6 L V8 (1UR-FE) engine	2WD	Standard	1710 lb. (775 kg)
				1635 lb. (740 kg)*2
UPK51L-THTDKA			Long	1835 lb. (830 kg)
		1760 lb. (795 kg)*2		
UPK55L-TRTDKA		4WD	Standard	1665 lb. (755 kg)
				1590 lb. (720 kg)*2
UPK56L-THTDKA	Long		1770 lb. (800 kg)	
		1695 lb. (765 kg)*2		
USK50L-TRTDKA	5.7 L V8 (3UR-FE) engine	2WD	Standard	1650 lb. (745 kg)
				1575 lb. (710 kg)*2
USK51L-THTDKA			Long	1960 lb. (885 kg)
		1885 lb. (855 kg)*2		
		2055 lb. (930 kg)*3		
USK55L-TRTDKA		4WD	Standard	1595 lb. (720 kg)
				1520 lb. (685 kg)*2
USK56L-THTDKA			Long	1895 lb. (855 kg)
		1820 lb. (825 kg)*2		
USK55L-TRTDGA	5.7 L V8 (3UR-FBE) engine	4WD	Standard	1595 lb. (720 kg)
				1520 lb. (685 kg)*2
USK56L-THTDGA			Long	1895 lb. (855 kg)
	1820 lb. (825 kg)*2			

*1. The model code is indicated on the Certification Label. (→P. 653)

*2. With towing package

*3. Without option

► Double Cab models

Model code* ¹	Engine	Driving system	Bed type	Vehicle capacity weight (Occupants+luggage)	
GSK51L-CRASKA	4.0 L V6 (1GR-FE) engine	2WD	Standard	1290 lb. (585 kg)	
UPK51L-CRTSKA	4.6 L V8 (1UR-FE) engine	2WD	Standard	1410 lb. (635 kg)	
UPK51L-CRTLKA				1335 lb. (605 kg) ^{*2}	
				1440 lb. (650 kg)	
				1365 lb. (615 kg) ^{*2}	
UPK52L-CHTSKA		Long	1325 lb. (600 kg) ^{*2}		
UPK56L-CRTSKA		4WD	Standard	1330 lb. (600 kg)	
				1255 lb. (565 kg) ^{*2}	
				1360 lb. (615 kg)	
	1285 lb. (580 kg) ^{*2}				
UPK57L-CHTSKA	Long	1235 lb. (560 kg) ^{*2}			
USK51L-CRTSKA	5.7 L V8 (3UR-FE) engine	2WD	Standard	1540 lb. (695 kg)	
				1465 lb. (660 kg) ^{*2}	
				1570 lb. (710 kg)	
				1495 lb. (675 kg) ^{*2}	
		USK52L-CHTSKA	Long	1455 lb. (655 kg) ^{*2}	
		USK56L-CRTSKA	4WD	Standard	1455 lb. (655 kg)
					1380 lb. (625 kg) ^{*2}
1485 lb. (670 kg)					
1410 lb. (635 kg) ^{*2}					
USK57L-CHTSKA	Long	1360 lb. (615 kg) ^{*2}			

Model code ^{*1}	Engine	Driving system	Bed type	Vehicle capacity weight (Occupants+luggage)
USK56L-CRTSGA	5.7 L V8 (3UR-FBE) engine	4WD	Standard	1455 lb. (655 kg)
				1380 lb. (625 kg) ^{*2}
USK56L-CRTLGA				1485 lb. (670 kg)
			1410 lb. (635 kg) ^{*2}	
USK57L-CHTSGA			Long	1360 lb. (615 kg) ^{*2}

*1: The model code is indicated on the Certification Label. (→P. 653)

*2: With towing package

► CrewMax models

Model code ^{*1}	Engine	Driving system	Bed type	Vehicle capacity weight (Occupants+luggage)		
UPK51L-PSTSKA	4.6 L V8 (1UR-FE) engine	2WD	Short	1330 lb. (600 kg)		
				1255 lb. (565 kg) ^{*2}		
				1220 lb. (550 kg) ^{*3}		
UPK51L-PSTLKA				1360 lb. (615 kg)		
				1285 lb. (580 kg) ^{*2}		
				1250 lb. (565 kg) ^{*3}		
UPK56L-PSTSKA		4WD		2WD	Short	1250 lb. (565 kg)
						1175 lb. (530 kg) ^{*2}
						1140 lb. (515 kg) ^{*3}
UPK56L-PSTLKA	4WD		4WD	Short		1265 lb. (570 kg)
						1190 lb. (535 kg) ^{*2}
						1155 lb. (520 kg) ^{*3}

Model code *1	Engine	Driving system	Bed type	Vehicle capacity weight (Occupants+luggage)
USK51L-PSTSKA	5.7 L V8 (3UR-FE) engine	2WD	Short	1445 lb. (655 kg)
				1370 lb. (620 kg) ^{*2}
				1335 lb. (605 kg) ^{*3}
USK51L-PSTLKA		1495 lb. (675 kg)		
		1420 lb. (640 kg) ^{*2}		
		1385 lb. (625 kg) ^{*3}		
USK56L-PSTSKA	4WD	Short	1375 lb. (620 kg)	
			1300 lb. (585 kg) ^{*2}	
			1265 lb. (570 kg) ^{*3}	
USK56L-PSTLKA			1405 lb. (635 kg)	
			1330 lb. (600 kg) ^{*2}	
			1295 lb. (585 kg) ^{*3}	
USK56L-PSTSGA	5.7 L V8 (3UR-FBE) engine	4WD	1375 lb. (620 kg)	
			1300 lb. (585 kg) ^{*2}	
			1265 lb. (570 kg) ^{*3}	
USK56L-PSTLGA			1405 lb. (635 kg)	
			1330 lb. (600 kg) ^{*2}	
			1295 lb. (585 kg) ^{*3}	

*1: The model code is indicated on the Certification Label. (→P. 653)

*2: With towing package or electric moon roof

*3: With towing package and electric moon roof

Towing capacity

► Regular Cab models

Model code*1	Engine	Driving system	Bed type	Towing capacity (Trailer weight + cargo)
GSK50L-TRADKA	4.0 L V6 (1GR-FE) engine	2WD	Standard	5200 lb. (2355 kg)
GSK51L-THADKA			Long	5100 lb. (2310 kg)
UPK50L-TRTDKA	4.6 L V8 (1UR-FE) engine	2WD	Standard	7500 lb. (3400 kg) ^{*2}
				9000 lb. (4080 kg) ^{*3}
UPK51L-THTDKA			Long	7400 lb. (3355 kg) ^{*2}
		8900 lb. (4035 kg) ^{*3}		
UPK55L-TRTDKA		4WD	Standard	7200 lb. (3265 kg) ^{*2}
				8700 lb. (3945 kg) ^{*3}
UPK56L-THTDKA	Long		7100 lb. (3220 kg) ^{*2}	
		8600 lb. (3900 kg) ^{*3}		
USK50L-TRTDKA	5.7 L V8 (3UR-FE) engine	2WD	Standard	8900 lb. (4035 kg) ^{*2}
				10400 lb. (4715 kg) ^{*3}
				9900 lb. (4490 kg) ^{*3,4}
USK51L-THTDKA		Long	8800 lb. (3990 kg) ^{*2}	
			10800 lb. (4895 kg) ^{*3}	
USK55L-TRTDKA		4WD	Standard	8700 lb. (3945 kg) ^{*2}
	10100 lb. (4580 kg) ^{*3}			
	9600 lb. (4355 kg) ^{*3,4}			
USK56L-THTDKA	Long	8600 lb. (3900 kg) ^{*2}		
		10500 lb. (4760 kg) ^{*3}		

Model code ^{*1}	Engine	Driving system	Bed type	Towing capacity (Trailer weight + cargo)
USK55L-TRTDGA	5.7 L V8 (3UR-FBE) engine	4WD	Standard	8700 lb. (3945 kg) ^{*2}
				10100 lb. (4580 kg) ^{*3}
				9600 lb. (4355 kg) ^{*3,4}
USK56L-THTDGA			Long	8600 lb. (3900 kg) ^{*2}
	10500 lb. (4760 kg) ^{*3}			

^{*1}: The model code is indicated on the Certification Label. (→P. 653)

^{*2}: Without towing package

^{*3}: With towing package

^{*4}: P275/55R20 tires

► Double Cab models

Model code*1	Engine	Driving system	Bed type	Towing capacity (Trailer weight + cargo)
GSK51L-CRASKA	4.0 L V6 (1GR-FE) engine	2WD	Standard	4800 lb. (2175 kg)
UPK51L-CRTSKA	4.6 L V8 (1UR-FE) engine	2WD	Standard	7200 lb. (3265 kg) ^{*2}
UPK51L-CRTLKA				8600 lb. (3900 kg) ^{*3}
				7100 lb. (3220 kg) ^{*2}
				8600 lb. (3900 kg) ^{*3}
UPK52L-CHTSKA		Long	8500 lb. (3855 kg)	
UPK56L-CRTSKA		4WD	Standard	6900 lb. (3130 kg) ^{*2}
UPK56L-CRTLKA				8300 lb. (3765 kg) ^{*3}
				6800 lb. (3085 kg) ^{*2}
				8300 lb. (3765 kg) ^{*3}
UPK57L-CHTSKA			Long	8200 lb. (3720 kg)
USK51L-CRTSKA	5.7 L V8 (3UR-FE) engine	2WD	Standard	8600 lb. (3900 kg) ^{*2}
USK51L-CRTLKA				10600 lb. (4805 kg) ^{*3}
				8600 lb. (3900 kg) ^{*2}
				10500 lb. (4760 kg) ^{*3}
USK52L-CHTSKA		Long	10400 lb. (4715 kg)	
USK56L-CRTSKA		4WD	Standard	8300 lb. (3760 kg) ^{*2}
USK56L-CRTLKA				10300 lb. (4670 kg) ^{*3}
				8300 lb. (3760 kg) ^{*2}
	10200 lb. (4625 kg) ^{*3}			
USK57L-CHTSKA	Long	10100 lb. (4580 kg)		

Model code ^{*1}	Engine	Driving system	Bed type	Towing capacity (Trailer weight + cargo)
USK56L-CRTSGA	5.7 L V8 (3UR-FBE) engine	4WD	Standard	8300 lb. (3760 kg) ^{*2}
USK56L-CRTLGA				10300 lb. (4670 kg) ^{*3}
USK57L-CHTSGA			Long	8300 lb. (3760 kg) ^{*2}
				10200 lb. (4625 kg) ^{*3}

*1: The model code is indicated on the Certification Label. (→P. 653)

*2: Without towing package

*3: With towing package

► CrewMax models

Model code*1	Engine	Driving system	Bed type	Towing capacity (Trailer weight + cargo)	
UPK51L-PSTSKA	4.6 L V8 (1UR-FE) engine	2WD	Short	7000 lb. (3175 kg) ^{*2}	
				8500 lb. (3855 kg) ^{*3}	
4WD				7000 lb. (3175 kg) ^{*2}	
				8500 lb. (3855 kg) ^{*3}	
		6700 lb. (3035 kg) ^{*2}			
		8200 lb. (3715 kg) ^{*3}			
		6700 lb. (3035 kg) ^{*2}			
		8100 lb. (3670 kg) ^{*3}			
USK51L-PSTSKA		5.7 L V8 (3UR-FE) engine		2WD	8400 lb. (3810 kg) ^{*2}
					10400 lb. (4715 kg) ^{*3}
4WD	8400 lb. (3810 kg) ^{*2}				
	10400 lb. (4715 kg) ^{*3}				
	8100 lb. (3670 kg) ^{*2}				
	10100 lb. (4580 kg) ^{*3}				
USK56L-PSTSKA	5.7 L V8 (3UR-FBE) engine		4WD	8100 lb. (3670 kg) ^{*2}	
				10100 lb. (4580 kg) ^{*3}	
4WD		8100 lb. (3670 kg) ^{*2}			
		10100 lb. (4580 kg) ^{*3}			
		8100 lb. (3670 kg) ^{*2}			
		10100 lb. (4580 kg) ^{*3}			
USK56L-PSTLKA		5.7 L V8 (3UR-FBE) engine	4WD	8100 lb. (3670 kg) ^{*2}	
				10100 lb. (4580 kg) ^{*3}	
4WD				8100 lb. (3670 kg) ^{*2}	
				10100 lb. (4580 kg) ^{*3}	
	8100 lb. (3670 kg) ^{*2}				
	10100 lb. (4580 kg) ^{*3}				
USK56L-PSTSGA	5.7 L V8 (3UR-FBE) engine		4WD	8100 lb. (3670 kg) ^{*2}	
				10100 lb. (4580 kg) ^{*3}	
4WD		8100 lb. (3670 kg) ^{*2}			
		10100 lb. (4580 kg) ^{*3}			
		8100 lb. (3670 kg) ^{*2}			
		10100 lb. (4580 kg) ^{*3}			
USK56L-PSTLGA		5.7 L V8 (3UR-FBE) engine	4WD	8100 lb. (3670 kg) ^{*2}	
				10100 lb. (4580 kg) ^{*3}	
4WD				8100 lb. (3670 kg) ^{*2}	
				10100 lb. (4580 kg) ^{*3}	
	8100 lb. (3670 kg) ^{*2}				
	10100 lb. (4580 kg) ^{*3}				

*1: The model code is indicated on the Certification Label. (→P. 653)

*2: Without towing package

*3: With towing package

Vehicle identification

■ Vehicle identification number

The vehicle identification number (VIN) is the legal identifier for your vehicle. This is the primary identification number for your Toyota. It is used in registering the ownership of your vehicle.

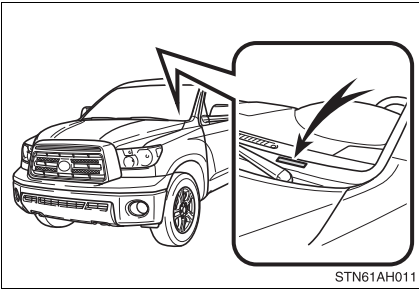

This number is stamped on the top left of the instrument panel.

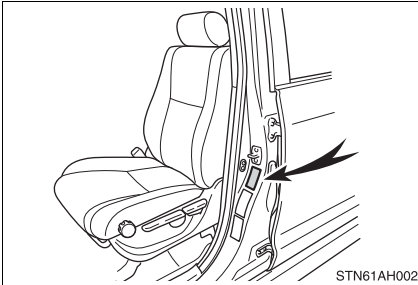

This number is also on the Certification Label.

■ **Engine number**

The engine number is stamped on the engine block as shown.

▶ **4.0 L V6 (1GR-FE) engine**

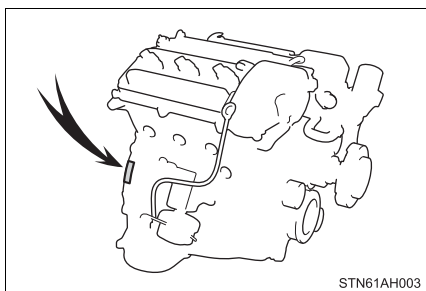

▶ **4.6 L V8 (1UR-FE) engine**

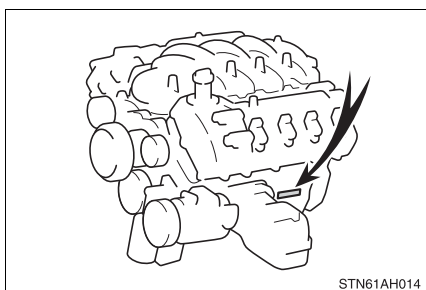

▶ **5.7 L V8 (3UR-FE, 3UR-FBE) engine**

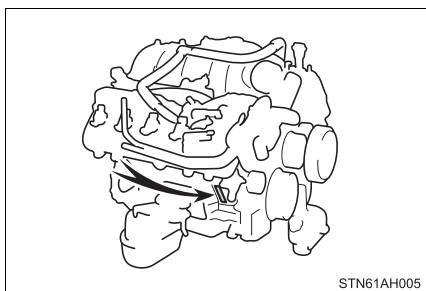

Engine

▶ 4.0 L V6 (1GR-FE) engine

Model	1GR-FE
Type	6-cylinder V-type, 4-cycle, gasoline
Bore and stroke	3.70 × 3.74 in. (94.0 × 95.0 mm)
Displacement	241.4 cu.in. (3956 cm ³)
Drive belt tension	Automatic adjustment
Valve clearance (engine cold)	
Intake	0.006 — 0.010 in. (0.15 — 0.25 mm)
Exhaust	0.011 — 0.015 in. (0.29 — 0.39 mm)

▶ 4.6 L V8 (1UR-FE) and 5.7 L V8 (3UR-FE, 3UR-FBE) engines

Model	1UR-FE, 3UR-FE, 3UR-FBE
Type	8-cylinder V-type, 4-cycle, gasoline
Bore and stroke	<p>▶ 4.6 L V8 (1UR-FE) engine 3.70 × 3.27 in. (94.0 × 83.0 mm)</p> <p>▶ 5.7 L V8 (3UR-FE, 3UR-FBE) engine 3.70 × 4.02 in. (94.0 × 102.0 mm)</p>
Displacement	<p>▶ 4.6 L V8 (1UR-FE) engine 281.2 cu.in. (4608 cm³)</p> <p>▶ 5.7 L V8 (3UR-FE, 3UR-FBE) engine 345.6 cu.in. (5663 cm³)</p>
Drive belt tension	Automatic adjustment
Valve clearance (engine cold)	
Intake	Automatic adjustment
Exhaust	

Fuel

Engine	Gasoline engine	Flex-fuel engine
Fuel type	Unleaded gasoline only	Unleaded gasoline, E85, or a blend of the two fuels
Octane rating (Unleaded gasoline)	87 (Research octane number 91) or higher	
Ethanol percentage (E85)	—	85% or less
Fuel tank capacity (Reference)	26.4 gal. (100.0 L, 22.0 Imp.gal.)	

Lubrication system

▶ 4.0 L V6 (1GR-FE) engine

Oil capacity Drain and refill (Reference)	
▶ With filter	5.5 qt. (5.2 L, 4.6 Imp.qt.)
▶ Without filter	5.2 qt. (4.9 L, 4.3 Imp.qt.)

■ Engine oil selection

“Toyota Genuine Motor Oil” is used in your Toyota vehicle. Use Toyota approved “Toyota Genuine Motor Oil” or equivalent to satisfy the following grade and viscosity.

Oil grade: ILSAC multigrade engine oil

Recommended viscosity: SAE 5W-30

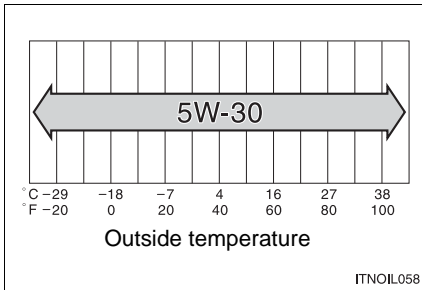

SAE 5W-30 is the best choice for good fuel economy and good starting in cold weather.

If SAE 5W-30 is not available, SAE 10W-30 oil may be used. However, it should be replaced with SAE 5W-30 at the next oil change.

The 5W portion of the oil viscosity rating indicates the characteristic of the oil which allows cold startability. Oils with a lower value before the W allow for easier starting of the engine in cold weather.

The 30 in 5W-30 indicates the oil viscosity when the oil is at its operating temperature. An oil with a higher viscosity may be better suited if the vehicle is operated at high speeds, or under extreme load conditions.

How to read oil container label:

The ILSAC (International Lubricant Standardization and Approval Committee) Certification Mark is added to some oil containers to help you select the oil you should use.



▶ 4.6 L V8 (1UR-FE) engine

Oil capacity Drain and refill (Reference)	
▶ With filter	7.9 qt. (7.5 L, 6.6 Imp.qt.)
▶ Without filter	7.4 qt. (7.1 L, 6.2 Imp.qt.)

■ Engine oil selection

“Toyota Genuine Motor Oil” is used in your Toyota vehicle. Use Toyota approved “Toyota Genuine Motor Oil” or equivalent to satisfy the following grade and viscosity.

Oil grade: ILSAC multigrade engine oil

Recommended viscosity: SAE 0W-20

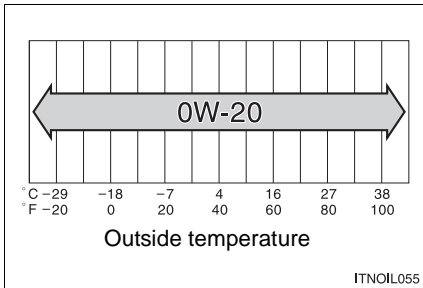

SAE 0W-20 is the best choice for good fuel economy and good starting in cold weather.

If SAE 0W-20 is not available, SAE 5W-20 oil may be used. However, it must be replaced with SAE 0W-20 at the next oil change.

The 0W portion of the oil viscosity rating indicates the characteristic of the oil which allows cold startability. Oils with a lower value before the W allow for easier starting of the engine in cold weather.

The 20 in 0W-20 indicates the oil viscosity when the oil is at its operating temperature. An oil with a higher viscosity may be better suited if the vehicle is operated at high speeds, or under extreme load conditions.

How to read oil container label:

The ILSAC (International Lubricant Standardization and Approval Committee) Certification Mark is added to some oil containers to help you select the oil you should use.



► 5.7 L V8 (3UR-FE, 3UR-FBE) engine

<p>Oil capacity Drain and refill (Reference)</p> <p>► With filter ► Without filter</p>	<p>7.9 qt. (7.5 L, 6.6 Imp.qt.) 7.4 qt. (7.1 L, 6.2 Imp.qt.)</p>
--	--

■ Engine oil selection

“Toyota Genuine Motor Oil” is used in your Toyota vehicle. Use Toyota approved “Toyota Genuine Motor Oil” or equivalent to satisfy the following grade and viscosity.

Oil grade: ILSAC multigrade engine oil

Recommended viscosity: SAE 5W-20 or 0W-20

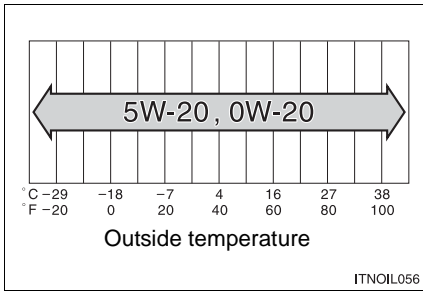

SAE 5W-20 or 0W-20 engine oil may be used. However, SAE 0W-20 is the best choice for good fuel economy and good starting in cold weather.

The 0W portion of the oil viscosity rating indicates the characteristic of the oil which allows cold startability. Oils with a lower value before the W allow for easier starting of the engine in cold weather.

The 20 in 0W-20 indicates the oil viscosity when the oil is at its operating temperature. An oil with a higher viscosity may be better suited if the vehicle is operated at high speeds, or under extreme load conditions.

How to read oil container label:

The ILSAC (International Lubricant Standardization and Approval Committee) Certification Mark is added to some oil containers to help you select the oil you should use.



Cooling system

Capacity	4.0 L V6 (1GR-FE) engine	10.1 qt. (9.6 L, 8.4 Imp.qt.)
	4.6 L V8 (1UR-FE) engine	<ul style="list-style-type: none"> ▶ Vehicles without towing package 12.8 qt. (12.1 L, 10.6 Imp.qt.) ▶ Vehicles with towing package 13.9 qt. (13.2 L, 11.6 Imp. qt.)
	5.7 L V8 (3UR-FE, 3UR-FBE) engine	<ul style="list-style-type: none"> ▶ Vehicles without towing package 12.8 qt. (12.1 L, 10.6 Imp.qt.) ▶ Vehicles with towing package 13.7 qt. (13.0 L, 11.4 Imp. qt.)
Coolant type	<p>Use either of the following.</p> <ul style="list-style-type: none"> • “Toyota Super Long Life Coolant” • Similar high-quality ethylene glycol-based non-silicate, non-amine, non-nitrite, and non-borate coolant with long-life hybrid organic acid technology <p>Do not use plain water alone.</p>	

Ignition system

Spark plug	
▶ 4.0 L V6 (1GR-FE) engine	
Make	DENSO
	NGK
Gap	0.043 in. (1.1 mm)
▶ 4.6 L V8 (1UR-FE) and 5.7 L V8 (3UR-FE, 3UR-FBE) engines	
Make	DENSO
	SK20HR11
Gap	0.043 in. (1.1 mm)

NOTICE

■ Iridium-tipped spark plugs (4.6 L V8 [1UR-FE] and 5.7 L V8 [3UR-FE, 3UR-FBE] engines)

Use only iridium-tipped spark plugs. Do not adjust gap when tuning engine.

Electrical system

Battery	
Open voltage at 68°F (20°C):	12.6 — 12.8 V Fully charged 12.2 — 12.4 V Half charged 11.8 — 12.0 V Discharged (Voltage checked 20 minutes after the key is removed with all the lights turned off)
Charging rates	5 A max.

Differential

Oil capacity	Front (4WD models)		2.2 qt. (2.05 L, 1.8 Imp.qt.)	
	Rear	4.0 L V6 (1GR-FE) and 4.6 L V8 (1UR-FE) engines	Regular Cab models	<ul style="list-style-type: none"> ▶ With standard bed 4.3 qt. (4.05 L, 3.6 Imp.qt.) ▶ With long bed 4.9 qt. (4.60 L, 4.0 Imp.qt.)
			Double Cab and CrewMax models	4.9 qt. (4.60 L, 4.0 Imp.qt.)
		5.7L V8 (3UR-FE, 3UR-FBE) engine	Regular Cab models	<ul style="list-style-type: none"> ▶ With standard bed 3.7 qt. (3.50 L, 3.1 Imp.qt.) ▶ With long bed 3.8 qt. (3.60 L, 3.2 Imp.qt.)
			Double Cab models	<ul style="list-style-type: none"> ▶ With standard bed 3.8 qt. (3.60 L, 3.2 Imp.qt.) ▶ With long bed 4.0 qt. (3.75 L, 3.3 Imp.qt.)
			CrewMax models	<ul style="list-style-type: none"> ▶ 2WD models 4.0 qt. (3.75 L, 3.3 Imp.qt.) ▶ 4WD models 3.8 qt. (3.60 L, 3.2 Imp.qt.)
Oil type and viscosity			<p>Toyota Genuine Differential Gear Oil LT 75W-85 GL-5 or equivalent</p> <p>“Toyota Genuine Differential Gear Oil” is filled in your Toyota vehicle at factory fill. Use Toyota approved “Toyota Genuine Differential Gear Oil” or an equivalent of matching quality to satisfy the above specification. Please contact your Toyota dealer for further details.</p>	

Automatic transmission

Fluid capacity*	4.0 L V6 (1GR-FE) engine		11.1 qt. (10.5 L, 9.2 Imp.qt.)
	4.6 L V8 (1UR-FE) engine	Vehicles without towing package	▶ 2WD models 11.6 qt. (11.0 L, 9.7 Imp.qt.) ▶ 4WD models 11.3 qt. (10.7 L, 9.4 Imp.qt.)
		Vehicles with towing package	▶ 2WD models 12.2 qt. (11.5 L, 10.1 Imp.qt.) ▶ 4WD models 11.8 qt. (11.2 L, 9.9 Imp.qt.)
	5.7 L V8 (3UR-FE, 3UR-FBE) engine	Vehicles without towing package	11.7 qt. (11.1 L, 9.8 Imp.qt.)
		Vehicles with towing package	12.3 qt. (11.6 L, 10.2 Imp.qt.)
Fluid type			Toyota Genuine ATF WS

*: The fluid capacity is the quantity of reference. If replacement is necessary, contact your Toyota dealer.

NOTICE

Automatic transmission fluid type

Using automatic transmission fluid other than “Toyota Genuine ATF WS” may cause deterioration in shift quality, locking up of your transmission accompanied by vibration, and ultimately damage the automatic transmission of your vehicle.

Transfer (4WD models)

Oil capacity	1.2 qt. (1.12 L, 1.0 Imp.qt.)
Oil type	Gear oil API GL-4 or GL-5
Recommended oil viscosity	SAE 75W-90

Brakes

Pedal clearance ^{*1}	4.1 in. (104 mm) Min.
Pedal free play	0.04 — 0.20 in. (1 — 5 mm)
Brake pad wear limit	0.04 in. (1.0 mm)
Parking brake lining wear limit	0.04 in. (1.0 mm)
Parking brake pedal travel ^{*2}	6 — 9 clicks
Fluid type	FMVSS No. 116 DOT 3 or SAE J1703

*1: Minimum pedal clearance when depressed with a force of 110 lbf (490 N, 50 kgf) with the engine running.

*2: Parking brake pedal travel when depressed with a force of 67.1 lbf (300 N, 30.6 kgf).

Chassis lubrication (4WD models)

Propeller shafts	Spider	Lithium base chassis grease, NLGI No.2
------------------	--------	--

Steering

Free play	Less than 1.2 in. (30 mm)
Power steering fluid type	Automatic transmission fluid DEXRON [®] II or III

Tires and wheels

► Type A

Tire size	P255/70R18 112T
Tire inflation pressure (Recommended cold tire inflation pressure)	Front tires: 30 psi (210 kPa, 2.1 kgf/cm ² or bar) Rear tires: 33 psi (230 kPa, 2.3 kgf/cm ² or bar) Spare tire: 33 psi (230 kPa, 2.3 kgf/cm ² or bar)
Wheel size	18 × 8J
Wheel nut torque	Steel wheels: 154 ft·lbf (209 N·m, 21.3 kgf·m) Aluminum wheels: 97 ft·lbf (131 N·m, 13.4 kgf·m)

► Type B

Tire size	P275/65R18 114T, P255/70R18 112T (spare tire)
Tire inflation pressure (Recommended cold tire inflation pressure)	Front tires: 30 psi (210 kPa, 2.1 kgf/cm ² or bar) Rear tires: 33 psi (230 kPa, 2.3 kgf/cm ² or bar) Spare tire: 33 psi (230 kPa, 2.3 kgf/cm ² or bar)
Wheel size	18 × 8J
Wheel nut torque	Steel wheels: 154 ft·lbf (209 N·m, 21.3 kgf·m) Aluminum wheels: 97 ft·lbf (131 N·m, 13.4 kgf·m)

► Type C

Tire size	P275/55R20 111H, P255/70R18 112T (spare tire)
Tire inflation pressure (Recommended cold tire inflation pressure)	Front tires: 30 psi (210 kPa, 2.1 kgf/cm ² or bar) Rear tires: 33 psi (230 kPa, 2.3 kgf/cm ² or bar) Spare tire: 33 psi (230 kPa, 2.3 kgf/cm ² or bar)
Wheel size	20 × 8J, 18 × 8J (spare wheel)
Wheel nut torque	Steel wheels: 154 ft·lbf (209 N·m, 21.3 kgf·m) Aluminum wheels: 97 ft·lbf (131 N·m, 13.4 kgf·m)

Light bulbs

	Light Bulbs	Bulb No.	W	Type
Exterior	Headlights (high beam)	9005	65	A
	Headlights (low beam)	H11	55	B
	Front fog lights	9145	45	C
	Front side marker lights	168	5	D
	Front turn signal/parking lights	4157 NAK-CF	28/8	E
	Rear turn signal lights	3157A	27/8	E
	Stop/tail and rear side marker lights	3157	27/8	D
	Back-up lights	921	18	D
	License plate lights	168	4.9	D
	High mounted stoplight and cargo lamp	921	18	D
	Outer foot light	—	5	D
Interior	Vanity lights	7065	1.4	F
	Personal/interior lights			
	Front	—	5	D
	Rear	—	5	D
	Foot well lighting	—	1.4	D
Door courtesy lights	168	5	D	

- A: HB3 halogen bulbs
- B: H11 halogen bulbs
- C: H10 halogen bulbs
- D: Wedge base bulbs (clear)
- E: Wedge base bulbs (amber)
- F: Double end bulbs

6-1. Specifications

Fuel information

▶ Gasoline engine

Your vehicle must use only unleaded gasoline.

Select octane rating 87 (Research Octane Number 91) or higher. The use of unleaded fuel with an octane rating lower than 87 may result in engine knocking. Persistent knocking can lead to engine damage.

At minimum, the gasoline you use should meet the specifications of ASTM D4814 in the U.S.A. and CGSB3.5-M93 in Canada.

▶ Flex-fuel engine

Your vehicle must use only unleaded gasoline, E85, or a blend of the two fuels.

Unleaded gasoline (Octane rating 87 [Research Octane Number 91] or higher), E85, or a blend of these two fuels is required for optimum engine performance.

The use of unleaded gasoline with an octane rating lower than 87 may result in engine knocking. Persistent knocking can lead to engine damage.

The use of fuel with an ethanol concentration in excess of 85% will have a negative impact on driving performance and can cause damage to the fuel system components.

At minimum, the gasoline you use should meet the specifications of ASTM D4814 in the U.S.A. and CGSB3.5-M93 in Canada.

At minimum, the E85 you use should meet the specifications of ASTM D5798 in the U.S.A.

■ Fuel tank opening for unleaded gasoline

To help prevent incorrect fueling, your Toyota has a fuel tank opening that only accommodates the special nozzle on unleaded fuel pumps.

■ If your engine knocks

- Consult your Toyota dealer.
- You may occasionally notice light knocking for a short time while accelerating or driving uphill. This is normal and there is no need for concern.

■ Fuel quality

In very few cases, driveability problems may be caused by the brand of fuel you are using. If driveability problems persist, try changing the brand of fuel. If this does not correct the problem, consult your Toyota dealer.

■ Gasoline quality standards

- Automotive manufacturers in the US, Europe and Japan have developed a specification for fuel quality called World-Wide Fuel Charter (WWFC) that is expected to be applied worldwide.
- The WWFC consists of four categories that are based on required emission levels. In the US, category 4 has been adopted.
- The WWFC improves air quality by lowering emissions in vehicle fleets, and customer satisfaction through better performance.

■ E85 fuel (Flex-fuel vehicles)

- E85 fuel is a blend of 85% ethanol and 15% gasoline. However, E85 does not necessarily contain 85% ethanol. The ethanol content of E85 is required by ASTM to be between 70% and 85%. For example, in cold climates the ethanol content of E85 may be reduced during the winter months to maintain cold weather starting performance.
- E85 has less energy per gallon than gasoline, so you will need to fill your fuel tank more frequently when using E85.
- The number of fuel stations that sell E85 fuel is limited. For more information about fueling stations, please refer to the U.S. Department of Energy Web site.
<http://www.eere.energy.gov/afdc/infrastructure/locator.html>

■ Toyota recommends the use of gasoline containing detergent additives

- Toyota recommends the use of gasoline that contains detergent additives to avoid build-up of engine deposits.
- All gasoline sold in the US contains detergent additives to clean and/or keep clean intake systems.

■ Toyota recommends the use of cleaner burning gasoline

Cleaner burning gasoline, including reformulated gasoline that contains oxygenates such as ethanol or MTBE (Methyl Tertiary Butyl Ether) is available in many areas.

Toyota recommends the use of cleaner burning gasoline and appropriately blended reformulated gasoline. These types of gasoline provide excellent vehicle performance, reduce vehicle emissions and improve air quality.

■ Toyota does not recommend blended gasoline (Gasoline engine)

- Toyota allows the use of oxygenate blended gasoline where the oxygenate content is up to 10% ethanol or 15% MTBE.
- If you use gasohol in your Toyota, be sure that it has an octane rating no lower than 87.
- Toyota does not recommend the use of gasoline containing methanol.

■ Toyota does not recommend gasoline containing MMT

Some gasoline contains octane enhancing additive called MMT (Methylcyclopentadienyl Manganese Tricarbonyl).

Toyota does not recommend the use of gasoline that contains MMT. If fuel containing MMT is used, your emission control system may be adversely affected.

The malfunction indicator lamp on the instrument cluster may come on. If this happens, contact your Toyota dealer for service.

■ Toyota does not recommend blended gasoline (Flex-fuel engine)

Do not use non-specified fuels such as the following.

- Fuels containing methanol.
- Fuels with more than 85% ethanol.

■ Toyota does not recommend the use of after-market fuel additives (Flex-fuel engine)

Do not use any after-market fuel additives when repeatedly refueling with E85, as some after-market fuel additives are not compatible with E85.

 NOTICE

■ **Notice on fuel quality**

- Do not use improper fuels.
If improper fuels are used the engine will be damaged.
- Do not use leaded gasoline.
Leaded gasoline can cause damage to your vehicle's three-way catalytic converters causing the emission control system to malfunction.
- Gasoline engine: Do not use gasohol other than that stated here.
Other gasohol may cause fuel system damage or vehicle performance problems.
- Use of unleaded gasoline with an octane rating lower than 87 may result in engine knocking. Persistent knocking can lead to engine damage and should be corrected by refueling with higher octane unleaded gasoline.

■ **When use of non-specified fuels (Flex-fuel engine)**

The use of non-specified fuels will have a negative impact on starting and driving performance, and will cause damage to the fuel system components. Therefore, do not add fuels such as the following.

- Fuels containing methanol
- Fuels with more than 85% ethanol

■ **Fuel-related poor driveability**

If after using a different type of fuel, poor driveability is encountered (poor hot starting, vaporization, engine knocking, etc.), discontinue the use of that type of fuel.

■ **When refueling**

Take care not to spill fuel.
It can damage your vehicle's paint.

6-1. Specifications

Tire information

Typical tire symbols

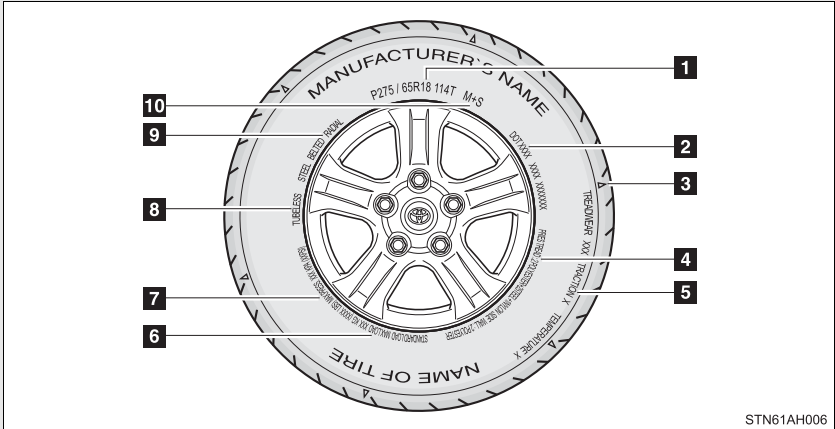

- 1** Tire size (→P. 675)
- 2** DOT and Tire Identification Number (TIN) (→P. 674)
- 3** Location of treadwear indicators (→P. 677)
- 4** Tire ply composition and materials

Ply is a layer of rubber-coated parallel cords. Cords are the strands which form the plies in a tire.

- 5** Uniform tire quality grading
- For details, see “Uniform Tire Quality Grading” that follows.

- 6** Load limit at maximum cold tire inflation pressure (→P. 678)
- 7** Maximum cold tire inflation pressure (→P. 678)

This means the pressure to which a tire may be inflated.

- 8** TUBELESS or TUBE TYPE

A tubeless tire does not have a tube and air is directly filled in the tire. A tube type tire has a tube inside the tire and the tube maintains the air pressure.

9 Radial tires or bias-ply tires

A radial tire has RADIAL on the sidewall. A tire not marked RADIAL is a bias-ply tire.

10 Summer tire or all season tire (→P. 545)

An all season tire has M+S on the sidewall. A tire not marked M+S is a summer tire.

Typical DOT and tire identification number (TIN)

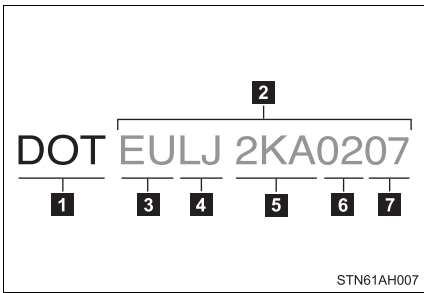

- 1** DOT symbol*
- 2** Tire Identification Number (TIN)
- 3** Tire manufacturer's identification mark
- 4** Tire size code
- 5** Manufacturer's optional tire type code (3 or 4 letters)
- 6** Manufacturing week
- 7** Manufacturing year

*:The DOT symbol certifies that the tire conforms to applicable Federal Motor Vehicle Safety Standards.

Tire size

■ Typical tire size information

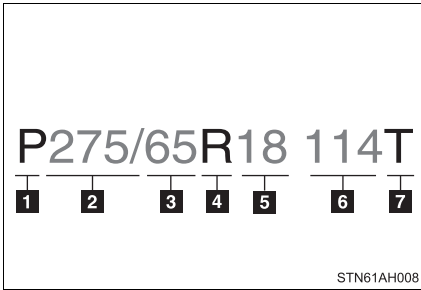

The illustration indicates typical tire size.

- 1** Tire use
(P = Passenger car,
T = Temporary use)
- 2** Section width (millimeters)
- 3** Aspect ratio
(tire height to section width)
- 4** Tire construction code
(R = Radial, D = Diagonal)
- 5** Wheel diameter (inches)
- 6** Load index (2 digits or 3 digits)
- 7** Speed symbol
(alphabet with one letter)

■ Tire dimensions

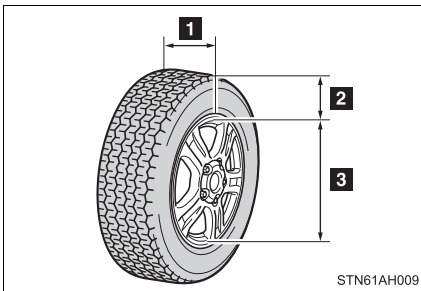

- 1** Section width
- 2** Tire height
- 3** Wheel diameter

Tire section names

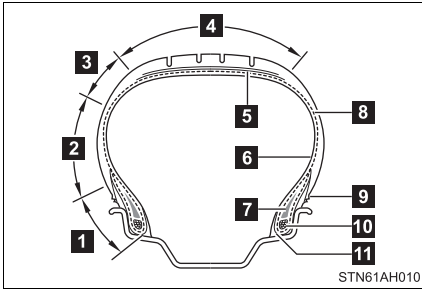

- 1 Bead
- 2 Sidewall
- 3 Shoulder
- 4 Tread
- 5 Belt
- 6 Inner liner
- 7 Reinforcing rubber
- 8 Carcass
- 9 Rim lines
- 10 Bead wires
- 11 Chafer

Uniform Tire Quality Grading

This information has been prepared in accordance with regulations issued by the National Highway Traffic Safety Administration of the U.S.A. Department of Transportation.

It provides the purchasers and/or prospective purchasers of Toyota vehicles with information on uniform tire quality grading.

Your Toyota dealer will help answer any questions you may have as you read this information.

■ DOT quality grades

All passenger vehicle tires must conform to Federal Safety Requirements in addition to these grades. Quality grades can be found where applicable on the tire sidewall between tread shoulder and maximum section width.

For example: Treadwear 200 Traction AA Temperature A

■ Treadwear

The treadwear grade is a comparative rating based on the wear rate of the tire when tested under controlled conditions on a specified government test course.

For example, a tire graded 150 would wear one and a half (1 - 1/2) times as well on the government course as a tire graded 100.

The relative performance of tires depends upon the actual conditions of their use, however, and may depart significantly from the norm due to variations in driving habits, service practices and differences in road characteristics and climate.

■ Traction AA, A, B, C

The traction grades, from highest to lowest, are AA, A, B and C, and they represent the tire's ability to stop on wet pavement as measured under controlled conditions on specified government test surfaces of asphalt and concrete.

A tire marked C may have poor traction performance.

Warning: The traction grade assigned to this tire is based on braking (straight ahead) traction tests and does not include cornering (turning) traction.

■ Temperature A, B, C

The temperature grades are A (the highest), B, and C, representing the tire's resistance to the generation of heat and its ability to dissipate heat when tested under controlled conditions on a specified indoor laboratory test wheel.

Sustained high temperature can cause the material of the tire to degenerate and reduce tire life, and excessive temperature can lead to sudden tire failure.

The grade C corresponds to a level of performance which all passenger car tires must meet under the Federal Motor Vehicle Safety Standard No. 109.

Grades B and A represent higher levels of performance on the laboratory test wheel than the minimum required by law.

Warning: The temperature grades for this tire are established for a tire that is properly inflated and not overloaded.

Excessive speed, underinflation, or excessive loading, either separately or in combination, can cause heat buildup and possible tire failure.

Glossary of tire terminology

Tire related term	Meaning
Cold tire inflation pressure	Tire pressure when the vehicle has been parked for three hours or more, or has not been driven more than 1 mile or 1.5 km under that condition
Maximum inflation pressure	The maximum cold inflated pressure to which a tire may be inflated, shown on the sidewall of the tire
Recommended inflation pressure	Cold tire inflation pressure recommended by a manufacturer
Accessory weight	The combined weight (in excess of those standard items which may be replaced) of transmission, power steering, power brakes, power windows, power seats, radio and heater, to the extent that these items are available as factory-installed equipment (whether installed or not)
Curb weight	The weight of a motor vehicle with standard equipment, including the maximum capacity of fuel, oil and coolant, and if so equipped, air conditioning and additional weight optional engine
Maximum loaded vehicle weight	The sum of: (a) Curb weight (b) Accessory weight (c) Vehicle capacity weight (d) Production options weight

Tire related term	Meaning
Normal occupant weight	150 lb. (68 kg) times the number of occupants specified in the second column of Table 1* that follows
Occupant distribution	Distribution of occupants in a vehicle as specified in the third column of Table 1* below
Production options weight	The combined weight of installed regular production options weighing over 5 lb. (2.3 kg) in excess of the standard items which they replace, not previously considered in curb weight or accessory weight, including heavy duty brakes, ride levelers, roof rack, heavy duty battery, and special trim
Rim	A metal support for a tire or a tire and tube assembly upon which the tire beads are seated
Rim diameter (Wheel diameter)	Nominal diameter of the bead seat
Rim size designation	Rim diameter and width
Rim type designation	The industry manufacturer's designation for a rim by style or code
Rim width	Nominal distance between rim flanges
Vehicle capacity weight (Total load capacity)	The rated cargo and luggage load plus 150 lb. (68 kg) times the vehicle's designated seating capacity
Vehicle maximum load on the tire	The load on an individual tire that is determined by distributing to each axle its share of the maximum loaded vehicle weight, and dividing by two
Vehicle normal load on the tire	The load on an individual tire that is determined by distributing to each axle its share of curb weight, accessory weight, and normal occupant weight (distributed in accordance with Table 1* below), and dividing by two

Tire related term	Meaning
Weather side	The surface area of the rim not covered by the inflated tire
Bead	The part of the tire that is made of steel wires, wrapped or reinforced by ply cords and that is shaped to fit the rim
Bead separation	A breakdown of the bond between components in the bead
Bias ply tire	A pneumatic tire in which the ply cords that extend to the beads are laid at alternate angles substantially less than 90 degrees to the centerline of the tread
Carcass	The tire structure, except tread and sidewall rubber which, when inflated, bears the load
Chunking	The breaking away of pieces of the tread or sidewall
Cord	The strands forming the plies in the tire
Cord separation	The parting of cords from adjacent rubber compounds
Cracking	Any parting within the tread, sidewall, or innerliner of the tire extending to cord material
CT	A pneumatic tire with an inverted flange tire and rim system in which the rim is designed with rim flanges pointed radially inward and the tire is designed to fit on the underside of the rim in a manner that encloses the rim flanges inside the air cavity of the tire
Extra load tire	A tire designed to operate at higher loads and at higher inflation pressures than the corresponding standard tire
Groove	The space between two adjacent tread ribs
Innerliner	The layer(s) forming the inside surface of a tubeless tire that contains the inflating medium within the tire

Tire related term	Meaning
Innerliner separation	The parting of the innerliner from cord material in the carcass
Intended outboard sidewall	(a)The sidewall that contains a whitewall, bears white lettering, or bears manufacturer, brand, and/or model name molding that is higher or deeper than the same molding on the other sidewall of the tire, or (b)The outward facing sidewall of asymmetrical tire that has a particular side that must always face outward when mounted on a vehicle
Light truck (LT) tire	A tire designated by its manufacturer as primarily intended for use on lightweight trucks or multipurpose passenger vehicles
Load rating	The maximum load that a tire is rated to carry for a given inflation pressure
Maximum load rating	The load rating for a tire at the maximum permissible inflation pressure for that tire
Maximum permissible inflation pressure	The maximum cold inflation pressure to which a tire may be inflated
Measuring rim	The rim on which a tire is fitted for physical dimension requirements
Open splice	Any parting at any junction of tread, sidewall, or innerliner that extends to cord material
Outer diameter	The overall diameter of an inflated new tire
Overall width	The linear distance between the exteriors of the sidewalls of an inflated tire, including elevations due to labeling, decorations, or protective bands or ribs
Passenger car tire	A tire intended for use on passenger cars, multipurpose passenger vehicles, and trucks, that have a gross vehicle weight rating (GVWR) of 10,000 lb. or less

Tire related term	Meaning
Ply	A layer of rubber-coated parallel cords
Ply separation	A parting of rubber compound between adjacent plies
Pneumatic tire	A mechanical device made of rubber, chemicals, fabric and steel or other materials, that, when mounted on an automotive wheel, provides the traction and contains the gas or fluid that sustains the load
Radial ply tire	A pneumatic tire in which the ply cords that extend to the beads are laid at substantially 90 degrees to the centerline of the tread
Reinforced tire	A tire designed to operate at higher loads and at higher inflation pressures than the corresponding standard tire
Section width	The linear distance between the exteriors of the sidewalls of an inflated tire, excluding elevations due to labeling, decoration, or protective bands
Sidewall	That portion of a tire between the tread and bead
Sidewall separation	The parting of the rubber compound from the cord material in the sidewall
Snow tire	A tire that attains a traction index equal to or greater than 110, compared to the ASTM E-1136 Standard Reference Test Tire, when using the snow traction test as described in ASTM F-1805-00, Standard Test Method for Single Wheel Driving Traction in a Straight Line on Snow-and Ice-Covered Surfaces, and which is marked with an Alpine Symbol () on at least one sidewall
Test rim	The rim on which a tire is fitted for testing, and may be any rim listed as appropriate for use with that tire

Tire related term	Meaning
Tread	That portion of a tire that comes into contact with the road
Tread rib	A tread section running circumferentially around a tire
Tread separation	Pulling away of the tread from the tire carcass
Treadwear indicators(TWI)	The projections within the principal grooves designed to give a visual indication of the degrees of wear of the tread
Wheel-holding fixture	The fixture used to hold the wheel and tire assembly securely during testing

*:Table 1 — Occupant loading and distribution for vehicle normal load for various designated seating capacities

Designated seating capacity, Number of occupants	Vehicle normal load, Number of occupants	Occupant distribution in a normally loaded vehicle
2 through 4	2	2 in front
5 through 10	3	2 in front, 1 in second seat
11 through 15	5	2 in front, 1 in second seat, 1 in third seat, 1 in fourth seat
16 through 20	7	2 in front, 2 in second seat, 2 in third seat, 1 in fourth seat

Customizable features

Your vehicle includes a variety of electronic features that can be personalized to your preferences. Programming these preferences requires specialized equipment and may be performed by an authorized Toyota dealership.

Some function settings are changed simultaneously with other functions being customized. Contact your Toyota dealer for further details.

Item	Function	Default setting	Customized setting
Wireless remote control (→P. 44)	Wireless remote control	ON	OFF
	Unlocking operation	Driver's door unlocked in one step, all doors unlocked in two steps	All doors unlocked in one step
	Automatic door lock function to be activated if door is not opened after being unlocked	ON	OFF
	Time elapsed before automatic door lock function is activated if door is not opened after being unlocked	60 seconds	0 seconds
			30 seconds
			120 seconds
	Operation signal (Emergency flashers)	ON	OFF
	Operation signal (Buzzer)	ON	OFF
	Panic function	ON	OFF
Buzzer sounds when pushing LOCK with any door not closed	ON	OFF	

Item	Function	Default setting	Customized setting
Door lock (→P. 47)	Speed-detecting automatic door lock function	ON	OFF
	Opening driver's door unlocks all doors.	OFF	ON
	Shifting gears to "P" unlocks all doors.	ON	OFF
	Shifting gears to position other than "P" locks all doors.	OFF	ON
	Unlocking using a key	Driver's door unlocked in one step, all doors unlocked in two steps	All doors unlocked in one step
Moon roof (→P. 104)	Door key linked operation	Open and close	Open only
			Close only
			OFF
Linked operation of components when door key is used	Slide only	Tilt only	
Automatic light off system (→P. 213)	Light sensor sensitivity	Level 3	Level 1 to 5
	Time elapsed before headlights automatically turn off after doors are closed	30 seconds	0 seconds
			60 seconds
			90 seconds

Item	Function	Default setting	Customized setting
Illumination (→P. 442)	Time elapsed before lights turn off	15 seconds	7.5 seconds
			30 seconds
	Operation after the engine is off	ON	OFF
	Operation when the doors are unlocked	ON	OFF
Seat Belt Reminder Buzzer (→P. 597)	Vehicle speed linked seat belt reminder buzzer	ON	OFF

6-2. Customization

Items to initialize

The following items must be initialized for normal system operation in cases such as after the battery is reconnected, or maintenance is performed on the vehicle.

Item	When to initialize	Reference
Moon roof	<ul style="list-style-type: none">• After reconnecting or changing the battery• After changing a fuse	P. 104
Engine oil maintenance data	After changing engine oil	P. 532
Tire pressure warning system	<ul style="list-style-type: none">• When rotating the tires on vehicles differing with front and rear tire inflation pressures.• When changing the tire inflation pressure by changing traveling speed or load weight, etc.• When changing the tire size.	P. 542

Reporting safety defects
for U.S. owners 690

Seat belt instructions for
Canadian owners
(in French) 691

Camper information 693

Reporting safety defects for U.S. owners

If you believe that your vehicle has a defect which could cause a crash or could cause injury or death, you should immediately inform the National Highway Traffic Safety Administration (NHTSA) in addition to notifying Toyota Motor Sales, U.S.A., Inc. (Toll-free: 1-800-331-4331).

If NHTSA receives similar complaints, it may open an investigation, and if it finds that a safety defect exists in a group of vehicles, it may order a recall and remedy campaign. However, NHTSA cannot become involved in individual problems between you, your dealer, or Toyota Motor Sales, U.S.A., Inc.

To contact NHTSA, you may call the Vehicle Safety Hotline toll-free at 1-888-327-4236 (TTY: 1-800-424-9153); go to <http://www.safercar.gov>, or write to: Administrator, NHTSA, 1200 New Jersey Ave, S.E., Washington, DC 20590. You can also obtain other information about motor vehicle safety from <http://www.safercar.gov>.

Seat belt instructions for Canadian owners (in French)

The following is a French explanation of seat belt instructions extracted from the seat belt section in this manual.

See the seat belt section for more detailed seat belt instructions in English.

Utilisation correcte des ceintures de sécurité

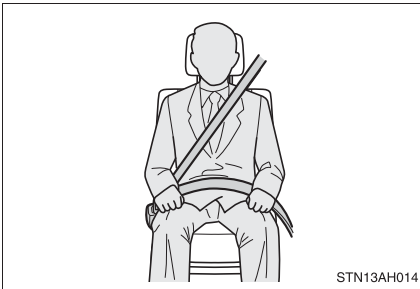

- Tirez sur la ceinture épaulière jusqu'à ce qu'elle recouvre entièrement l'épaule; elle ne doit cependant pas toucher le cou ni glisser de l'épaule.
- Placez la sangle abdominale de la ceinture de sécurité le plus bas possible sur les hanches.
- Réglez la position du dossier du siège. Tenez-vous assis dans le fond du siège, le dos droit.
- Ne tournez pas la ceinture de sécurité.

Entretien et soins

■ Ceintures de sécurité

Avec un tissu ou une éponge, nettoyez à l'aide d'un savon doux et de l'eau tiède. Vérifiez aussi les ceintures régulièrement pour vous assurer qu'elles ne présentent pas d'usure excessive, d'effilochage ou de coupures.

ATTENTION

■ Dommages et usure de la ceinture de sécurité

Vérifiez périodiquement le système de ceintures de sécurité. Assurez-vous qu'il n'y a pas de coupures, d'effilochures ni de pièces desserrées. N'utilisez pas une ceinture de sécurité endommagée avant qu'elle soit remplacée. Des ceintures de sécurité endommagées ne peuvent pas protéger les occupants contre les blessures.

Camper information

This information has been prepared in accordance with regulation issued by the National Highway Traffic Safety Administration of the U.S. Department of Transportation. It provides the purchasers and/or prospective purchasers of Toyota vehicles with information on truck-camper loading. Your Toyota dealer will help answer any questions you may have as you read this information.

Center of gravity location

The figures given in the illustration indicate the recommended center of gravity zone.

► Regular Cab models with standard bed

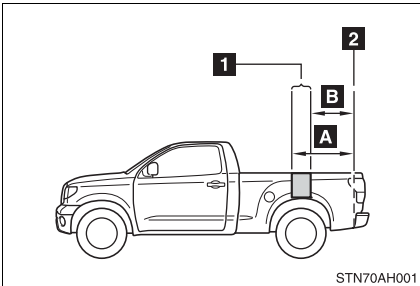

- 1 Recommended location for cargo center of gravity for cargo weight rating
- 2 Rear end of truck bed

► Regular Cab models with long bed

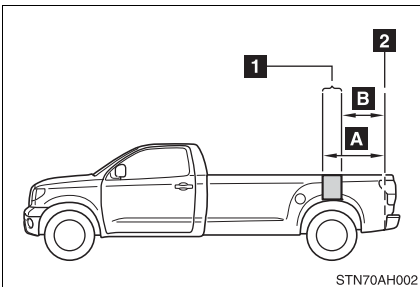

- 1 Recommended location for cargo center of gravity for cargo weight rating
- 2 Rear end of truck bed

► Double Cab models with standard bed

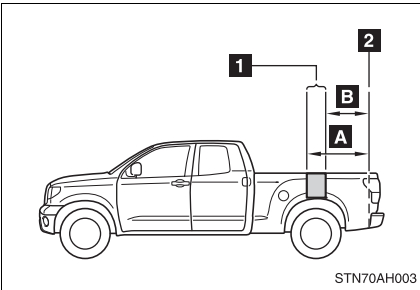

- 1 Recommended location for cargo center of gravity for cargo weight rating
- 2 Rear end of truck bed

► Double Cab models with long bed

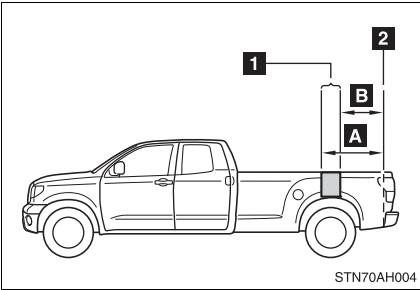

- 1 Recommended location for cargo center of gravity for cargo weight rating
- 2 Rear end of truck bed

► CrewMax models

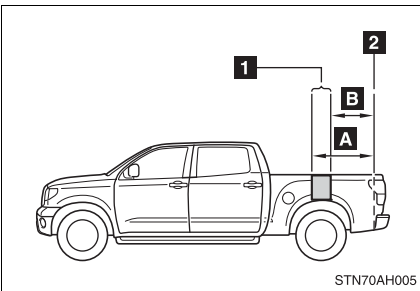

- 1 Recommended location for cargo center of gravity for cargo weight rating
- 2 Rear end of truck bed

	A	B
Regular Cab models	42.6 in. (1082mm)	37.6 in. (955 mm)
Double Cab models		
CrewMax models		

CAUTION

■ Loading precaution

If a load is too far back, it can cause dangerous handling. If it is too far forward, the front axle may be overloaded.

Cargo weight rating and proper matching

When the truck is used to carry a slide-in camper, the total cargo load of the truck consists of the manufacturer's camper weight figure, the weight of installed additional camper equipment not included in the manufacturer's camper weight figure, the weight of camper cargo, and the weight of passengers in the camper.

The total cargo load should not exceed the truck's cargo weight rating and the camper's center of gravity should fall within the truck's recommended center of gravity zone when installed.

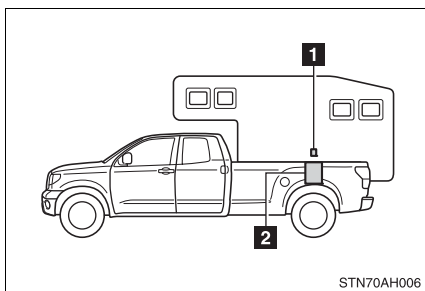

- 1 Camper center of gravity
- 2 Recommended center of gravity location zone

■ Cargo weight rating

CWR: Cargo Weight Rating

Engine	Drive	Cab	Bed	Grade	Passenger number	C.W.R	
						(lb.)	(kg)
1GR-FE	2WD	Regular	Standard	Delux	3	1045	474
			Long		3	1125	510
1UR-FE	2WD		Standard		3	1205	547
			Long		3	1305	592
1UR-FE	4WD		Standard		3	1145	519
			Long		3	1240	562
3UR-FE	2WD		Standard		3	1135	515
			Long		3	1450	658
3UR-FE 3UR-FBE	4WD		Standard		3	1080	490
			Long		3	1385	628

CWR: Cargo Weight Rating

Engine	Drive	Cab	Bed	Grade	Passenger number	C.W.R	
						(lb.)	(kg)
1GR-FE	2WD	Double	Standard	SR5	6	400	181
1UR-FE	2WD		Standard	SR5	6	440	200
				Limited	5	625	284
	Long		SR5	6	405	184	
	4WD		Standard	SR5	6	355	161
Limited				5	535	243	
3UR-FE	2WD		Long	SR5	6	320	145
				SR5	6	575	261
				Limited	5	765	347
3UR-FE 3UR-FBE	4WD		Standard	SR5	6	555	252
				SR5	6	495	225
				Limited	5	680	308
				Long	SR5	6	465
		SR5			6	465	211

CWR: Cargo Weight Rating

Engine	Drive	Cab	Bed	Grade	Passenger number	C.W.R	
						(lb.)	(kg)
1UR-FE	2WD	Crew Max	Short	SR5	6	325	147
				Limited	5	500	227
	4WD			SR5	6	250	113
				Limited	5	420	191
3UR-FE	2WD			SR5	6	460	209
				Limited	5	665	302
3UR-FE 3UR-FBE	4WD			SR5	6	390	177
				Limited	5	560	254

 CAUTION

Overloading

Be careful — overloading can cause dangerous braking and handling problems, and can damage your vehicle and its tires.

Gross axle and vehicle weight ratings

Secure loose items to prevent weight shifts that could affect the balance of your vehicle. When the truck camper is loaded, drive to a scale and weigh on the front and on the rear wheels separately to determine axle loads. Individual axle loads should not exceed either of the Gross Axle Weight Ratings (GAWR). The total of the axle loads should not exceed the Gross Vehicle Weight Rating (GVWR). These ratings are given on the vehicle certification label which is located on the door latch post on the left side of the vehicle. (→P. 653) If weight ratings are exceeded, move or remove items to bring all weights below the ratings.

► Gross axle weight rating

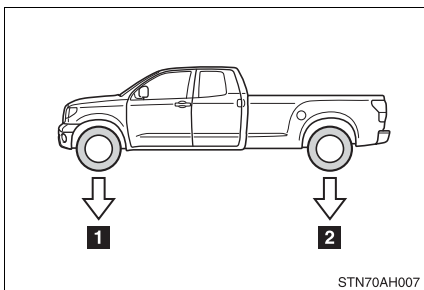

1 Front GAWR

2 Rear GAWR

► Gross vehicle weight rating

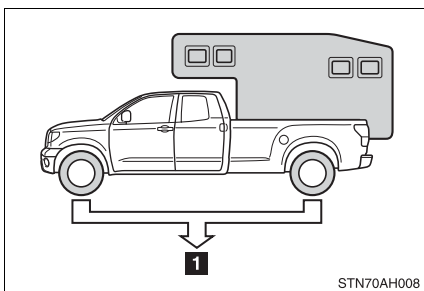

1 Not exceed GVWR

■ GAWR and GVWR

► Regular Cab models

Model code*	Engine	Driving system	Bed type	GAWR		GVWR	
				Front	Rear		
GSK50L-TRADKA	4.0 L V6 (1GR-FE) engine	2WD	Standard	3900 lb. (1765 kg)	3700 lb. (1675 kg)	6200 lb. (2810 kg)	
GSK51L-THADKA			Long		3800 lb. (1720 kg)	6400 lb. (2900 kg)	
UPK50L-TRTDKA	4.6 L V8 (1UR-FE) engine	2WD	Standard	3900 lb. (1765 kg)	3950 lb. (1790 kg)	6600 lb. (2990 kg)	
UPK51L-THTDKA			Long		4050 lb. (1835 kg)	6800 lb. (3080 kg)	
UPK55L-TRTDKA		4WD	Standard	4000 lb. (1810 kg)	4050 lb. (1835 kg)	6800 lb. (3080 kg)	
UPK56L-THTDKA			Long		4150 lb. (1880 kg)	7000 lb. (3175 kg)	
USK50L-TRTDKA		5.7 L V8 (3UR-FE) engine	2WD	Standard	3900 lb. (1765 kg)	3950 lb. (1790 kg)	6600 lb. (2990 kg)
USK51L-THTDKA				Long		4150 lb. (1880 kg)	7000 lb. (3175 kg)
USK55L-TRTDKA	4WD		Standard	4000 lb. (1810 kg)	4050 lb. (1835 kg)	6800 lb. (3080 kg)	
USK56L-THTDKA			Long		4150 lb. (1880 kg)	7200 lb. (3265 kg)	
USK55L-TRTDGA	5.7 L V8 (3UR-FBE) engine	4WD	Standard	4000 lb. (1810 kg)	4050 lb. (1835 kg)	6800 lb. (3080 kg)	
USK56L-THTDGA			Long		4150 lb. (1880 kg)	7200 lb. (3265 kg)	

*: The model code is indicated on the Certification Label. (→P. 653)

► Double Cab models

Model code*	Engine	Driving system	Bed type	GAWR		GVWR
				Front	Rear	
GSK51L-CRASKA	4.0 L V6 (1GR-FE) engine	2WD	Standard	3900 lb. (1765 kg)	3800 lb. (1720 kg)	6400 lb. (2900 kg)
UPK51L-CRTSKA	4.6 L V8 (1UR-FE) engine	2WD	Standard	3900 lb. (1765 kg)	4000 lb. (1810 kg)	6700 lb. (3035 kg)
UPK51L-CRTLKA			Long		4050 lb. (1835 kg)	6800 lb. (3080 kg)
UPK52L-CHTSKA			4WD		Standard	4000 lb. (1810 kg)
UPK56L-CRTSKA		Long		4150 lb. (1880 kg)	7000 lb. (3175 kg)	
UPK56L-CRTLKA		Standard		4000 lb. (1810 kg)	4150 lb. (1880 kg)	
UPK57L-CHTSKA						
USK51L-CRTSKA	5.7 L V8 (3UR-FE) engine	2WD	Standard	3900 lb. (1765 kg)	4100 lb. (1855 kg)	6900 lb. (3125 kg)
USK51L-CRTLKA			Long		4150 lb. (1880 kg)	7000 lb. (3175 kg)
USK52L-CHTSKA			4WD		Standard	4000 lb. (1810 kg)
USK56L-CRTSKA		Long		7200 lb. (3265 kg)		
USK56L-CRTLKA						
USK57L-CHTSKA						

Model code*	Engine	Driving system	Bed type	GAWR		GVWR
				Front	Rear	
USK56L-CRTSGA	5.7 L V8 (3UR-FBE) engine	4WD	Standard	4000 lb. (1810 kg)	4150 lb. (1880 kg)	7100 lb. (3220 kg)
USK56L-CRTLGA						
USK57L-CHTSGA			Long			7200 lb. (3265 kg)

*: The model code is indicated on the Certification Label. (→P. 653)

► CrewMax models

Model code*	Engine	Driving system	Bed type	GAWR		GVWR
				Front	Rear	
UPK51L-PSTSKA	4.6 L V8 (1UR-FE) engine	2WD	Short	3900 lb. (1765 kg)	4050 lb. (1835 kg)	6800 lb. (3080 kg)
UPK51L-PSTLKA						
UPK56L-PSTSKA		4WD		4000 lb. (1810 kg)	4150 lb. (1880 kg)	7000 lb. (3175 kg)
UPK56L-PSTLKA						
USK51L-PSTSKA	5.7 L V8 (3UR-FE) engine	2WD		3900 lb. (1765 kg)	4150 lb. (1880 kg)	7000 lb. (3175 kg)
USK51L-PSTLKA						
USK56L-PSTSKA		4WD		4000 lb. (1810 kg)		7200 lb. (3265 kg)
USK56L-PSTLKA						

Model code*	Engine	Driving system	Bed type	GAWR		GVWR
				Front	Rear	
USK56L-PSTSGA	5.7 L V8 (3UR-FBE) engine	4WD	Short	4000 lb. (1810 kg)	4150 lb. (1880 kg)	7200 lb. (3265 kg)
USK56L-PSTLGA						

*: The model code is indicated on the Certification Label. (→P. 653)

Index

Abbreviation list	706
Alphabetical index.....	708
What to do if.....	718

For details of equipment related to the navigation system and navigation system screen, refer to the "Navigation System Owner's Manual".

Abbreviation/Acronym list

ABBREVIATIONS	MEANING
2WD	Two Wheel Drive
4WD	Four Wheel Drive
ABS	Anti-Lock Brake System
ACC	Accessory
AI-SHIFT	Artificial Intelligence shifting
ALR	Automatic Locking Retractor
A-TRAC	Active Traction Control
AUTO LSD	Automatic Limited Slip Differential
CAL	Calibration
CRS	Child Restraint System
ECU	Electronic Control Unit
EDR	Event Data Recorder
ELR	Emergency Locking Retractor
FFV	Flexible Fuel Vehicle
GAWR	Gross Axle Weight Rating
GCWR	Gross Combination Weight Rating
GVWR	Gross Vehicle Weight Rating
I/M	Emission inspection and maintenance
INFO	Information
LATCH	Lower Anchors and Tethers for Children
LED	Light Emitting Diode
LT	Light truck
M + S	Mud + Snow
MMT	Methylcy clopentadienyl Manganese Tricarbonyl
MTBE	Methyl Tertiary Butyl Ether
OBD	On Board Diagnostics
PWR	Power

ABBREVIATIONS	MEANING
RES	Resume
RSCA	Roll Sensing of Curtain shield Airbags
SRS	Supplemental Restraint System
TIN	Tire Identification Number
TPMS	Tire Pressure Warning System
TRAC	Traction Control
TWI	Treadwear indicators
VIN	Vehicle Identification Number
VSC	Vehicle Stability Control

A	A/C	288, 297
	ABS	243
	Accessory meter	210
	Active traction control system	243
	Air conditioning filter	555
	Air conditioning system	
	Air conditioning filter.....	555
	Automatic air conditioning system.....	288
	Manual air conditioning system.....	297
	Airbags	
	Airbag operating conditions.....	123
	Airbag precautions for your child.....	128
	Airbag warning light.....	596
	Curtain shield airbag operating conditions.....	124
	Curtain shield airbag precautions.....	130
	Front passenger occupant classification system.....	136
	General airbag precautions.....	127
	Locations of airbags.....	120
	Modification and disposal of airbags.....	131
	Passenger airbag off switch.....	132, 151
	Proper driving posture.....	118, 127
	Roll sensing of curtain shield airbag off switch.....	134
	Side airbag operating conditions.....	124
	Side airbag precautions.....	129
	SRS airbags.....	120
	Alarm	116
	Antenna	319
	Anti-lock brake system	
	ABS warning light.....	596

Anti-lock brake system.....	243
Armrest	495
Ashtray	479
Audio input	356
Audio remote controls	358
Audio system	
A/V input adapter.....	403
Antenna.....	319
Audio input.....	356
Audio visual input.....	403
AUX adapter.....	356
CD player/changer.....	322
DVD player.....	386
iPod®.....	339
MP3/WMA disc.....	331
Optimal use.....	352
Portable music player.....	356
Radio.....	314
Rear seat entertainment system.....	377
Steering wheel audio switch.....	358
Type.....	310
USB memory.....	345
Audio visual input	403
AUTO LSD system	240
Automatic light control system	215
Automatic transmission	
Automatic transmission.....	186
If the shift lever cannot be shifted from P.....	627
TOW/HAUL switch.....	189
AUX adapter	356
Auxiliary boxes	469
A/V input adapter	403
B	
Back-up lights	
Replacing light bulbs.....	577
Wattage.....	668
Back window	
Back window.....	100
Power back window.....	101

Back window defogger 307

Battery

- Charging system warning light 595
- Checking 538
- If the vehicle has discharged battery 631
- Preparing and checking before winter 260

Bluetooth® audio..... 361

Bluetooth® phone 413

Bottle holders 467

Brakes

- Brake system warning buzzer 241, 247
- Brake system warning light 595
- Fluid..... 535
- Parking brake 192

Brake assist..... 243

Break-in tips 175

C

Camper information 693

Card holder 453

Care

- Exterior 512
- Interior 514
- Seat belts 515

Cargo capacity 258

Cargo hooks 499

Cargo lamp

- Replacing light bulbs 578
- Switch 446
- Wattage 668

CD changer

- CD 322
- MP3 331
- WMA disc 331

CD player 322

Certification label 272, 653

Chains 261

Child restraint system

- Booster seats, definition 143

- Booster seats, installation 160
- Convertible seats, definition 143
- Convertible seats, installation 159
- Front passenger occupant classification system 136
- Infant seats, definition 143
- Infant seats, installation 158
- Installing CRS with lower anchorages 152, 155, 156
- Installing CRS with seat belts 158
- Installing CRS with top tether straps 161, 163, 167
- Passenger airbag off switch 132, 151

Child safety

- Airbag precautions 127
- Battery precautions 539, 633
- Child restraint system 143
- Child-protectors 49
- How your child should wear the seat belt 82
- Installing child restraints 149
- Moon roof precautions 108
- Power window lock switch 98
- Power window precautions 99
- Removed wireless remote control battery precautions 559
- Seat belt extender precautions 84
- Seat belt precautions 83
- Seat heater precautions 492, 494

Child-protectors 49

Cigarette lighter 481

Cleaning

- Exterior 512
- Interior 514
- Seat belts 515

Clock 476

Compass.....506
Condenser535
Console box450
Cooling system
 Engine overheating634
CRS143
Cruise control.....221
Cup holders464
Curtain shield airbags120
Customizable features.....206, 684

D

Daytime running light system215
Deck hooks.....498
Defogger
 Back window307
 Side mirrors305, 307
Dimension.....640
Dinghy towing285
Display
 Trip information204
 Warning message604
Do-it-yourself maintenance.....523
Doors
 Door glasses96
 Door lock44, 48
 Open door warning597, 605
 Side doors47
 Side mirrors91
Driver's seat belt reminder buzzer597, 599
Driver's seat belt reminder light.....597, 599
Driving
 Break-in tips175
 Correct posture118
 Driving assist systems243
 Procedures174
 Winter driving tips260
Driving position memory.....70
DVD player.....386

E

Emergency flashers.....584
Emergency flashers switch584
Emergency, in case of
 Blown fuse560
 If the engine will not start625
 If the shift lever cannot be shifted627
 If the vehicle has discharged battery631
 If the warning buzzer sounds595
 If the warning light turns on595
 If the warning message is displayed604
 If you have a flat tire608
 If you lose your keys630
 If you think something is wrong591
 If your vehicle becomes stuck637
 If your vehicle has to be stopped in an emergency ...638
 If your vehicle needs to be towed585
 If your vehicle overheats634
Engine
 Compartment528
 Engine switch183
 Exhaust gas180
 Hood527
 How to start the engine183
 Identification number654
 If the engine will not start625
 Ignition switch183
 Immobilizer system114
 Overheating634
 Warning light596
Engine coolant
 Capacity661
 Checking534

Preparing and checking
before winter 260

Engine coolant temperature gauge 194

Engine immobilizer system.... 114

Engine oil

Capacity 656

Checking 530

Preparing and checking
before winter 260

Warning light 596

Engine oil maintenance data 532

Engine switch 183

Event data recorder 593

F

FFV 109, 669

Flex-fuel 109, 669

Flexible fuel vehicle 109, 669

Floor mat..... 497

Fluid

Brake 535

Washer 540

Fog lights

Replacing light bulbs 576

Switch 217

Wattage 668

Four-wheel drive system 236

Front fog lights

Replacing light bulbs 576

Switch 217

Wattage 668

Front passenger occupant classification system..... 136

Front passenger's seat belt reminder light..... 597

Front passenger's seat belt warning buzzer..... 597, 599

Front seats

Adjustment 60

Front side marker lights

Replacing light bulbs 575

Switch 213

Wattage 668

Front turn signal lights

Replacing light bulbs 574

Switch 191

Wattage 668

Fuel

Capacity 656

Fuel gauge 194

Fuel pump shut off system 592

Gas station information 724

Information 669

Refueling 109

Type 656

Warning light 598

Warning message 606

Fuel door..... 109

Fuel filler door 109

Fuel pump shut off system 592

Fuses..... 560

G

Garage door opener..... 501

Gas station information..... 724

Gauges..... 194

Glove box..... 449

H

Hands-free system (for cellular phone)..... 413

Hazard lights switch 584

Head restraints

Adjusting 73

Headlights

Replacing light bulbs 572, 573

Switch 213

Wattage 668

High mounted stoplight

Replacing 578

Wattage 668

Heaters

Seat heaters 491

Seat heaters and ventilators 493

Side mirror 305, 307

Hood.....527

Hooks

Cargo net499

Deck hooks498

Shopping bag499

Horn.....193

I **I/M test**.....522

Identification

Engine654

Tire674

Vehicle653

Ignition switch.....183

Illuminated entry system.....442

Immobilizer system.....114

Indicator lights200

Initialization

Items to initialize.....687

Engine oil maintenance
data532

Moon roof106

Tire pressure warning
system543

Inside rear view mirror88

Interior lights

Interior lights.....442, 443, 444

Personal lights.....442, 443, 444

Switch.....443

Wattage.....668

Instrument panel light

control199

Intuitive parking assist.....224

J **Jack**

Positioning the jack616

Vehicle-equipped jack608

Jack handle614

K **Keyless entry**.....44

Keys

Engine switch183

If you lose your keys630

Ignition switch183

Keyless entry44

Key number.....42

Keys42

Wireless remote control44

L **License plate lights**

Replacing light bulbs579

Switch213

Wattage.....668

Light bulbs

Replacing.....571

Wattage.....668

Lights

Automatic light off system215

Cargo lamp switch446

Emergency flasher
switch.....584

Fog light switch217

Hazard light switch.....584

Headlight switch.....213

Instrument panel light
control dial199

Interior light switch443, 444

Outer foot lights.....442

Personal light switch444

Replacing light bulbs.....571

Turn signal lever191

Vanity lights.....475

Wattage.....668

Load capacity.....258

Lock steering column.....184

Luggage storage box447, 472

Luggage compartment

features498

M **Maintenance**

Do-it-yourself

maintenance523

General maintenance.....519

Maintenance data640

Maintenance requirements ...517

	Vehicle exterior.....	512
	Vehicle interior.....	514
	Malfunction indicator lamp	596
	Manual air conditioning	
	system	297
	Manual headlight leveling	
	dial.....	214
	Master warning light	598, 604
	Map holder	456
	Meter	
	Accessory meter.....	210
	Instrument panel light	
	control	199
	Meters	194
	Mirrors	
	Inside rear view mirror.....	88
	Side mirror heaters.....	305, 307
	Side mirrors.....	91
	Vanity mirrors	475
	Moon roof.....	104
	MP3 disc.....	331
	Multi-information	
	display	204
N	Noise from under vehicle	36
O	Odometer	194
	Off-road precautions.....	250
	Oil	
	Engine oil.....	530
	Warning light	596, 598
	Opener	
	Hood.....	527
	Outside rear view mirrors	
	Adjusting and folding.....	91
	Outside temperature	
	display	477
	Overhead console.....	463
	Overheating, Engine	634
P	Parking assist.....	224
	Parking brake	192

Parking lights	
Replacing light bulbs.....	574
Switch.....	213
Wattage.....	668
Passenger airbag off switch	
Installing the child restraint	
system	151
Passenger airbag off switch	
precautions	146
Passenger airbag off	
switch.....	132
Passenger risk group	133
Pen holder	459
Personal lights	
Switch.....	444
Wattage.....	668
Power back window.....	101
Power outlet	482, 487
Power steering	
Fluid	537, 665
Power windows	96
R	
Radiator	535
Radio	314
Rear seat	
Adjustment	65
Folding down.....	67
Raising the bottom cushion.....	66
Rear seat entertainment	
system	377
Rear seat entertainment	
system controller battery.....	383
Rear side marker lights	
Replacing light bulbs.....	577
Switch.....	213
Rear seat adjustment.....	65
Rear seat adjustment	
precautions	68
Rear turn signal lights	
Replacing light bulbs.....	577
Switch.....	191
Wattage.....	668

Rear view mirror
 Anti-glare.....88, 94
 Compass.....506

Rear view monitor system.....230

Rear window.....100, 101

Replacing
 Fuses.....560
 Light bulbs.....571
 Tires.....608
 Wireless remote control
 battery.....558
 Wheels.....553

Rear step bumper.....58

Reporting safety defects for U.S.A. owners.....690

Roll sensing of curtain shield airbags off switch.....134

S

Seatback table.....496

Seat belts
 Adjusting the seat belt.....77
 ALR.....81
 Automatic Locking
 Retractor.....81
 Child restraint system
 installation.....149
 Cleaning and maintaining
 the seat belts.....515
 ELR.....81
 Emergency Locking
 Retractor.....81
 How to wear your seat belt.....77
 How your child should wear
 the seat belt.....82
 Pregnant women,
 proper seat belt use.....81
 Reminder buzzer.....597, 599
 Reminder light.....597
 Seat belt extenders.....82
 Seat belt pretensioners.....80

Seat heaters.....491

Seat heaters and ventilators.....493

Seating capacity.....258

Seats
 Adjustment.....60, 65
 Adjustment precautions64, 68
 Child seats/child restraint
 system installation.....149
 Cleaning.....514
 Folding down the rear
 seat.....67
 Folding down the rear seat
 precaution.....68
 Folding passenger's seat
 (vehicles with seatback
 table).....63
 Front seat adjustment.....60
 Front seat adjustment
 precautions.....64
 Driver's seat position
 memory.....70
 Head restraint.....73
 Properly sitting in the seat.....118
 Raising the bottom
 cushion.....66
 Seat heaters.....491
 Seat heaters and
 ventilators.....493

Service reminder indicators.....202

Shift lever
 Automatic transmission.....186
 If the shift lever cannot
 be shifted.....627

Shift lock system.....627

Shopping bag hooks.....499

Side airbags.....120

Side doors.....47

Side marker lights
 Replacing.....575, 577
 Switch.....213
 Wattage.....668

Side mirrors
 Adjusting and folding 91
 Mirror position memory 70

Spare tire
 Inflation pressure 666
 Replacing 616
 Storage location 608

Spark plug..... 662

Specifications..... 640

Speedometer 194

SRS airbags
 Curtain shield airbags..... 120
 Front airbags 120
 Knee airbags 120
 Passenger airbag off
 switch 132
 Precautions 127
 Roll sensing of curtain shield
 airbag off switch 134
 Side airbags 120

Steering
 Column lock release 85

Steering wheel
 Adjustment 85
 Audio switches 358
 Steering wheel memory 70
 Telephone switches 418

Stop lights
 Replacing light bulbs 577
 Wattage 668

Storage feature..... 447

Storage precautions 257

Stuck
 If your vehicle becomes
 stuck 637

Sun visors..... 474

Switch
 Cruise control switch 221
 Emergency flasher switch 584
 Engine switch 183
 Fog light switch 217
 Front-wheel drive control
 switch 236

T **Tachometer**..... 194

Tailgate
 Removing the tailgate 53
 Tailgate 52

Tail lights
 Replacing light bulbs 577
 Switch 213
 Wattage 668

Talk switch..... 418

Telephone switch..... 418

Theft deterrent system
 Alarm 116
 Engine immobilizer system ... 114

Tire inflation pressure 549

Tire information
 Glossary 678
 Size 675
 Tire identification number 674
 Uniform tire quality
 grading 676

Tires
 Chains 261

Checking542
 Identification number.....674
 If you have a flat tire.....608
 Inflation pressure.....549, 666
 Information673
 Inflation pressure sensor.....543
 Replacing608
 Rotating tires542
 Size666
 Snow tires260
 Tire pressure warning
 reset switch.....543
 Tire pressure warning
 system542, 598
 Warning light598
Tissue pocket.....461
Tools608
Total load capacity.....258
TOW/HAUL switch189
Towing
 Bumper towing275
 Dinghy towing.....285
 Emergency towing.....585
 Fifth wheel trailer.....273
 Trailer towing.....264
Traction control.....243
TRAC.....243
Trip information204
Trip meter198
Turn signal lights
 Replacing light bulbs.....574, 577
 Switch.....191
 Wattage.....668
V
Valet key42
Vanity lights
 Vanity lights.....475
 Wattage.....668
Vanity mirrors.....475
Vehicle identification
 number653
Vehicle stability control.....243
VSC.....243

W

Warning buzzers
 Brake system595
 Key reminder.....50, 599
 Open door597, 599
 Seat belt reminder.....597, 599
Warning lights
 ABS.....596
 Airbag system596
 Anti-lock brake system.....596
 Automatic transmission
 fluid temperature.....597
 Brake assist system596
 Brake system595
 Charging system595
 Electronic engine control
 system596
 Engine oil pressure596
 Four-wheel drive system
 warning buzzer599
 Driver's seat belt597
 Front passenger occupant
 classification system.....596
 Front passenger's
 seat belt.....597
 Low brake fluid.....595
 Low engine oil pressure596
 Low fuel level598, 606
 Low tire inflation
 pressure.....598
 Malfunction indicator lamp596
 Master warning light.....598
 Open door597
 Power steering warning
 light.....597
 Pretensioners.....596
 Seat belt reminder light597
 SRS airbags.....596
 Tire pressure warning light...598
 VSC/TRAC.....597
Warning messages604
Washer
 Checking540

Preparing and checking	
before winter	260
Switch	218
Washing and waxing.....	512
Weight	
Cargo capacity	258
Cargo weight rating	696
Gross axle weight rating.....	700
Gross vehicle weight rating ..	700
Vehicle capacity weight	644
Towing capacity.....	648
Load limits	258
Weight	644, 648, 696, 700
Wheels.....	553
Window glasses	96, 100, 101
Window lock switch	98
Windows	
Back window defogger	307
Power back window.....	101
Power windows	96
Washer	218
Windshield wiper	
de-icer	305, 307
Windshield wipers.....	218
Wireless remote control	
Replacing the battery	558
Wireless remote control.....	44
Winter driving tips.....	260
WMA disc	331

What to do if...

What to do if...

A tire punctures

P. 608 If you have a flat tire

The engine does not start

P. 625 If the engine will not start

P. 114 Engine immobilizer system

P. 631 If the vehicle battery is discharged

The shift lever cannot be moved out

P. 627 If the shift lever cannot be shifted from P

The engine coolant temperature gauge enters the red zone

P. 634 If your vehicle overheats

Steam can be seen coming from under the hood

The key is lost

P. 630 If you lose your keys

The battery runs out

P. 631 If the vehicle battery is discharged

The doors cannot be locked

P. 47 Side doors

The horn begins to sound.

P. 116 Alarm

The vehicle is stuck in mud or sand

P. 637 If the vehicle becomes stuck

The warning light or indicator light comes on

P. 595 If a warning light turns on

■ Instrument cluster

- ▶ Vehicles with multi-information display

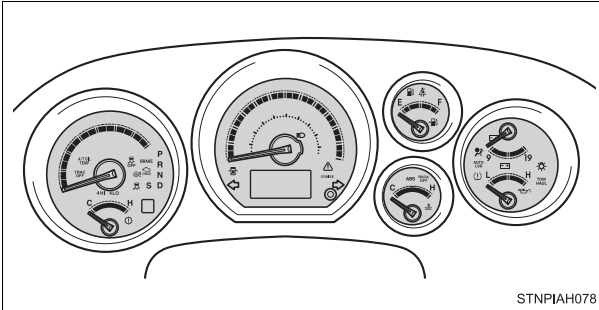

- ▶ Vehicles without multi-information display (type A)

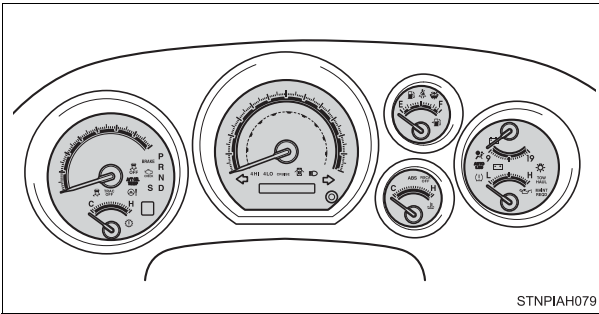

► Vehicles without multi-information display (type B)

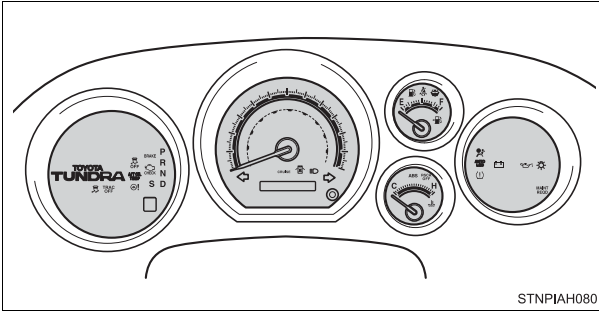

■ Center panel

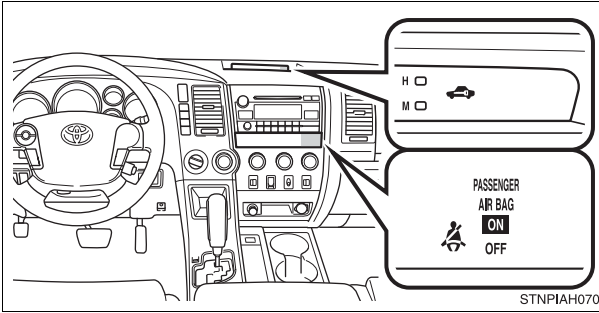

■ Warning lights

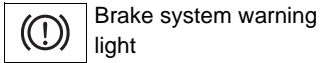

Brake system warning light

or



P. 595



Charging system warning light

P. 595



Malfunction indicator lamp

P. 596



ABS warning light

or



P. 596



Engine oil replacement reminder light

P. 598



SRS warning light

P. 596



Automatic transmission fluid temperature warning light

P. 597



Low washer fluid warning light

P. 598



Power steering warning light

P. 597

(if equipped)



Low engine oil pressure warning light

P. 596



Master warning light

P. 598



Slip indicator*

P. 597



Tire pressure warning light

P. 598



Open door warning light

P. 597



Low fuel level warning light

P. 598



Driver's seat belt reminder light

P. 597



Front passenger's seat belt reminder light

P. 597

*: Slip indicator comes on.

The warning message is displayed

P. 604

If a warning message is displayed

GAS STATION INFORMATION

Auxiliary catch lever

P. 527

Fuel filler door

P. 109

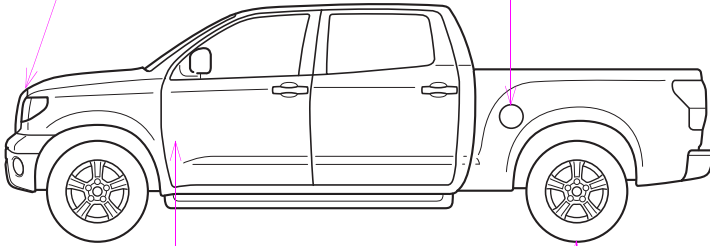

Hood lock release lever

P. 527

Tire inflation pressure

P. 666

STNPIAH024

Fuel tank capacity		26.4 gal. (100.0 L, 22.0 Imp.gal.)	
Fuel type		P. 656	
Cold tire inflation pressure		P. 666	
Engine oil capacity (Drain and refill)	4.0 L V6 (1GR-FE) engine	With filter Without filter	qt. (L, Imp.qt.) 5.5 (5.2, 4.6) 5.2 (4.9, 4.3)
	4.6 L V8 (1UR-FE) and 5.7 L V8 (3UR-FE, 3UR-FBE) engines	With filter Without filter	qt. (L, Imp.qt.) 7.9 (7.5, 6.6) 7.4 (7.1, 6.2)
Engine oil type		P. 656	