

# 2013 GMC Sierra Owner Manual

<b>In Brief</b> .....	1-1	<b>Storage</b> .....	4-1	<b>Climate Controls</b> .....	8-1
Instrument Panel .....	1-2	Storage Compartments .....	4-1	Climate Control Systems .....	8-1
Initial Drive Information .....	1-7	<b>Instruments and Controls</b> .....	5-1	Air Vents .....	8-10
Vehicle Features .....	1-24	Controls .....	5-2	<b>Driving and Operating</b> .....	9-1
Performance and		Warning Lights, Gauges, and		Driving Information .....	9-2
Maintenance .....	1-31	Indicators .....	5-10	Starting and Operating .....	9-23
<b>Keys, Doors, and</b>		Information Displays .....	5-28	Engine Exhaust .....	9-31
<b>Windows</b> .....	2-1	Vehicle Messages .....	5-37	Automatic Transmission .....	9-32
Keys and Locks .....	2-1	Vehicle Personalization .....	5-46	Drive Systems .....	9-38
Doors .....	2-8	Universal Remote System .....	5-54	Brakes .....	9-50
Vehicle Security .....	2-10	<b>Lighting</b> .....	6-1	Ride Control Systems .....	9-53
Exterior Mirrors .....	2-13	Exterior Lighting .....	6-1	Cruise Control .....	9-56
Interior Mirrors .....	2-16	Interior Lighting .....	6-7	Object Detection Systems .....	9-59
Windows .....	2-17	Lighting Features .....	6-8	Fuel .....	9-65
Roof .....	2-20	<b>Infotainment System</b> .....	7-1	Towing .....	9-71
<b>Seats and Restraints</b> .....	3-1	Introduction .....	7-1	Conversions and	
Head Restraints .....	3-2	Radio .....	7-10	Add-Ons .....	9-101
Front Seats .....	3-3	Audio Players .....	7-17	<b>Vehicle Care</b> .....	10-1
Rear Seats .....	3-9	Rear Seat Infotainment .....	7-38	General Information .....	10-2
Safety Belts .....	3-11	Phone .....	7-49	Vehicle Checks .....	10-3
Airbag System .....	3-20	Trademarks and License		Headlamp Aiming .....	10-34
Child Restraints .....	3-38	Agreements .....	7-56	Bulb Replacement .....	10-34
				Electrical System .....	10-38
				Wheels and Tires .....	10-46

# 2013 GMC Sierra Owner Manual

---

Jump Starting .....	10-82	<b>Technical Data</b> .....	12-1
Towing .....	10-87	Vehicle Identification .....	12-1
Appearance Care .....	10-91	Vehicle Data .....	12-2
<b>Service and Maintenance</b> ...	11-1	<b>Customer Information</b> .....	13-1
General Information .....	11-1	Customer Information .....	13-2
Maintenance Schedule .....	11-3	Reporting Safety Defects ....	13-17
Special Application		Vehicle Data Recording and	
Services .....	11-8	Privacy .....	13-19
Additional Maintenance		<b>OnStar</b> .....	14-1
and Care .....	11-9	OnStar Overview .....	14-1
Recommended Fluids,		OnStar Services .....	14-2
Lubricants, and Parts .....	11-12	OnStar Additional	
Maintenance Records .....	11-16	Information .....	14-5
		<b>Index</b> .....	i-1



The names, logos, emblems, slogans, vehicle model names, and vehicle body designs appearing in this manual including, but not limited to, GM, the GM logo, GMC, the GMC Truck Emblem, and SIERRA are trademarks and/or service marks of General Motors LLC, its subsidiaries, affiliates, or licensors.

This manual describes features that may or may not be on your specific vehicle either because they are options that you did not purchase or due to changes subsequent to the printing of this owner manual.

Please refer to the purchase documentation relating to your specific vehicle to confirm each of the features found on your vehicle. For vehicles first sold in Canada, substitute the name "General Motors of Canada Limited" for GMC Division wherever it appears in this manual.

If the vehicle has the Duramax<sup>®</sup> diesel engine, see the Duramax diesel supplement for additional and specific information on this engine.

If the vehicle is a hybrid, see the hybrid supplement for more information.

Keep this manual in the vehicle for quick reference.

## Canadian Vehicle Owners

### Propriétaires Canadiens

A French language copy of this manual can be obtained from your dealer or from:

On peut obtenir un exemplaire de ce guide en français auprès du concessionnaire ou à l'adresse suivante:

Helm, Incorporated  
Attention: Customer Service  
47911 Halyard Drive  
Plymouth, MI 48170

### Using this Manual

To quickly locate information about the vehicle, use the Index in the back of the manual. It is an alphabetical list of what is in the manual and the page number where it can be found.

### Danger, Warnings, and Cautions

Warning messages found on vehicle labels and in this manual describe hazards and what to do to avoid or reduce them.

**Danger** indicates a hazard with a high level of risk which will result in serious injury or death.

**Warning** or **Caution** indicates a hazard that could result in injury or death.

 **WARNING**

These mean there is something that could hurt you or other people.

**Notice:** This means there is something that could result in property or vehicle damage. This would not be covered by the vehicle's warranty.



A circle with a slash through it is a safety symbol which means “Do Not,” “Do not do this,” or “Do not let this happen.”

### Symbols

The vehicle has components and labels that use symbols instead of text. Symbols are shown along with the text describing the operation or information relating to a specific component, control, message, gauge, or indicator.

 : This symbol is shown when you need to see your owner manual for additional instructions or information.

 : This symbol is shown when you need to see a service manual for additional instructions or information.

## Vehicle Symbol Chart

Here are some additional symbols that may be found on the vehicle and what they mean. For more information on the symbol, refer to the Index.

 : Adjustable Pedals

 : Airbag Readiness Light

 : Air Conditioning

 : Antilock Brake System (ABS)

 : Audio Steering Wheel Controls or OnStar®

 : Brake System Warning Light

 : Charging System

 : Cruise Control

 : Engine Coolant Temperature

 : Exterior Lamps

 : Fog Lamps

 : Fuel Gauge

 : Fuses

 : Headlamp High/Low-Beam Changer

 : Heated Steering Wheel

 : LATCH System Child Restraints

 : Malfunction Indicator Lamp

 : Oil Pressure

 : Outside Power Foldaway Mirrors

 : Power

 : Remote Vehicle Start

 : Safety Belt Reminders

 : Tire Pressure Monitor

 : Tow/Haul Mode

 : Traction Control/StabiliTrak®

 : Windshield Washer Fluid



## **In Brief**

### **Instrument Panel**

Instrument Panel (Base/Uplevel Version) .....	1-2
Instrument Panel (Premium Version) .....	1-5

### **Initial Drive Information**

Initial Drive Information .....	1-7
Remote Keyless Entry (RKE) System .....	1-7
Remote Vehicle Start .....	1-8
Door Locks .....	1-8
Windows .....	1-9
Seat Adjustment .....	1-10
Memory Features .....	1-12
Heated and Ventilated Seats .....	1-13
Head Restraint Adjustment .....	1-13

Safety Belts .....	1-13
Passenger Sensing System .....	1-14
Mirror Adjustment .....	1-14
Steering Wheel Adjustment .....	1-16
Throttle and Brake Pedal Adjustment .....	1-17
Interior Lighting .....	1-17
Exterior Lighting .....	1-18
Windshield Wiper/Washer .....	1-18
Climate Controls .....	1-19
Transmission .....	1-21
Four-Wheel Drive .....	1-22

### **Vehicle Features**

Radio(s) .....	1-24
Satellite Radio .....	1-25
Portable Audio Devices .....	1-25
Bluetooth® .....	1-26
Steering Wheel Controls .....	1-26
Cruise Control .....	1-27

Navigation System .....	1-27
Driver Information Center (DIC) .....	1-27
Rear Vision Camera (RVC) .....	1-28
Ultrasonic Parking Assist .....	1-28
Power Outlets .....	1-29
Universal Remote System .....	1-29
Sunroof .....	1-29

### **Performance and Maintenance**

StabiliTrak® System .....	1-31
Tire Pressure Monitor .....	1-31
Engine Oil Life System .....	1-32
Fuel E85 (85% Ethanol) .....	1-32
Driving for Better Fuel Economy .....	1-33
Roadside Assistance Program .....	1-33
OnStar® .....	1-33

## Instrument Panel

### Instrument Panel (Base/Uplevel Version)

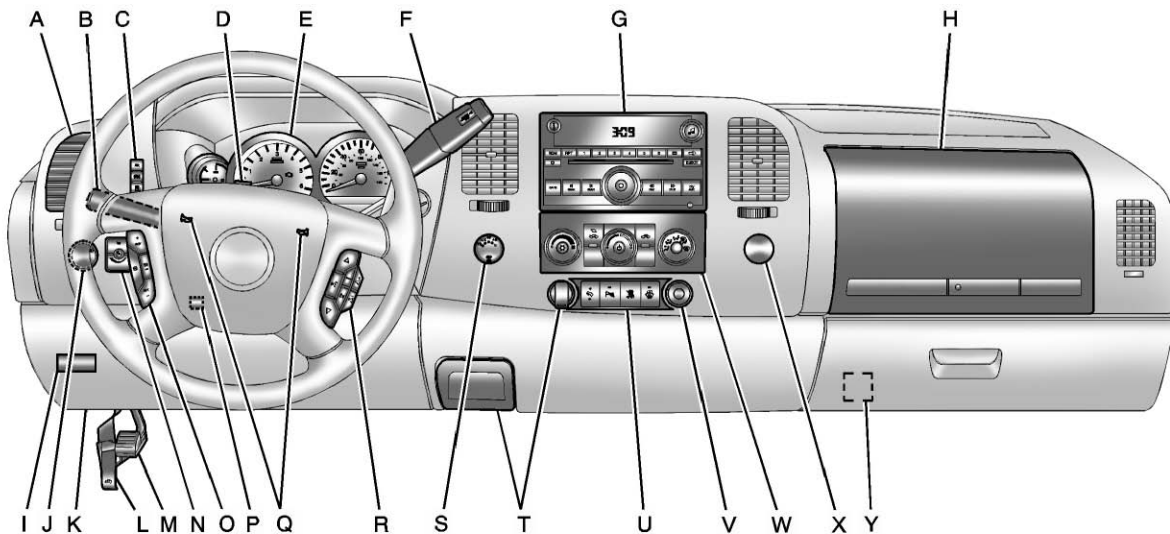



- A. *Air Vents on page 8-10.*
- B. *Turn and Lane-Change Lever. See Turn and Lane-Change Signals on page 6-5. Windshield Wiper/Washer on page 5-4.*
- C. *Driver Information Center (DIC) Buttons. See Driver Information Center (DIC) on page 5-28.*
- D. *Hazard Warning Flashers on page 6-5 (Out of View).*
- E. *Instrument Cluster on page 5-11.*
- F. *Shift Lever. See Automatic Transmission on page 9-32. Tow/Haul Selector Button (If Equipped). See Tow/Haul Mode on page 9-37. Range Selection Mode (Allison Transmission and Hydra-Matic® 6-Speed Button) (If Equipped). See Manual Mode on page 9-36.*
- G. *Infotainment on page 7-1.*
- H. *Instrument Panel Storage on page 4-1.*
- I. *Integrated Trailer Brake Controller (If Equipped). See Trailer Towing on page 9-73.*
- J. *Exterior Lamp Controls on page 6-1.*
- K. *Data Link Connector (DLC) (Out of View). See Malfunction Indicator Lamp on page 5-21.*
- L. *Hood Release. See Hood on page 10-4.*
- M. *Parking Brake on page 9-51.*
- N. *Dome Lamps on page 6-7. Fog Lamps on page 6-6 (If Equipped).*
- O. *Cruise Control on page 9-56.*
- P. *Steering Wheel Adjustment on page 5-2.*
- Q. *Horn on page 5-4.*
- R. *Steering Wheel Controls on page 5-2 (If Equipped).*
- S. *Automatic Transfer Case Control (If Equipped). See Four-Wheel Drive on page 10-28.*
- T. *Ashtray (If Equipped). See Ashtrays on page 5-10 and Cigarette Lighter on page 5-9.*
- U. *StabiliTrak® System on page 9-53 (If Equipped). Ultrasonic Parking Assist on page 9-59 (If Equipped). Pedal Adjust Button (If Equipped). See Adjustable Throttle and Brake Pedal on page 9-23. Exhaust Brake (If Equipped). See “Brakes” in the Duramax diesel supplement.*
- V. *Power Outlets on page 5-9.*

## 1-4 In Brief

---

W. *Climate Control Systems (with Air Conditioning) on page 8-1 or Climate Control Systems (with Heater Only) on page 8-4 (If Equipped).*

*Dual Automatic Climate Control System on page 8-5 (If Equipped).*

X. Power Take Off (PTO) Control (If Equipped). See Power Take Off (PTO) in the Duramax diesel supplement.

Y. Passenger Airbag Off Control (If Equipped). See *Airbag On-Off Switch on page 3-28.*

## Instrument Panel (Premium Version)

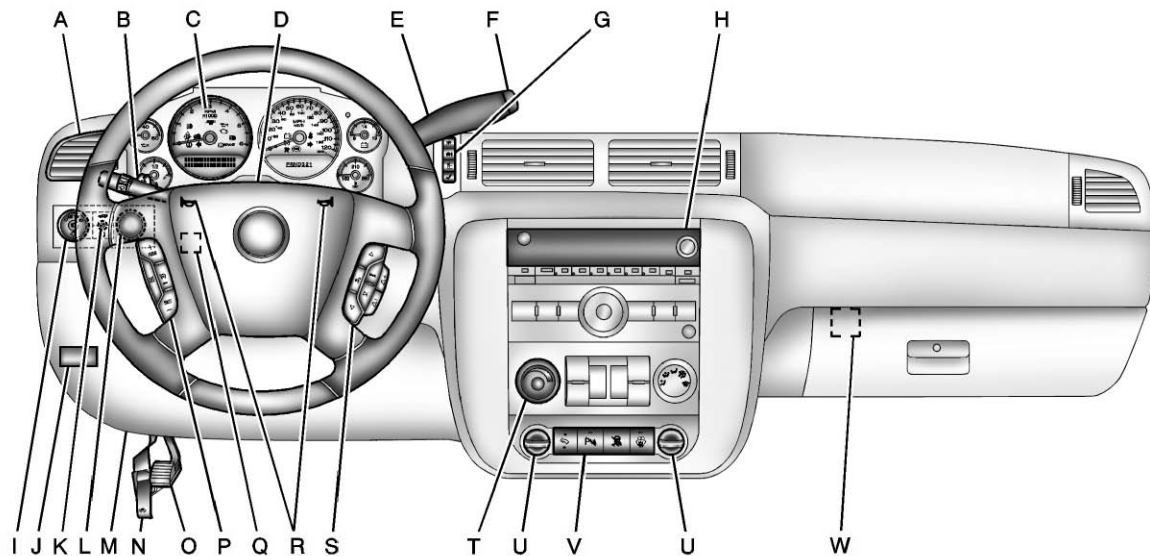

## 1-6 In Brief

---

- A. *Air Vents on page 8-10.*
- B. *Turn and Lane-Change Lever. See Turn and Lane-Change Signals on page 6-5.*  
*Windshield Wiper/Washer on page 5-4.*
- C. *Instrument Cluster on page 5-11.*
- D. *Hazard Warning Flashers on page 6-5 (Out of View).*
- E. *Shift Lever. See Automatic Transmission on page 9-32.*  
*Range Selection Mode (If Equipped). See Manual Mode on page 9-36.*
- F. *Tow/Haul Mode on page 9-37 (If Equipped).*
- G. *Driver Information Center (DIC) Buttons. See Driver Information Center (DIC) on page 5-28.*
- H. *Infotainment on page 7-1.*
- I. *Exterior Lamp Controls on page 6-1.*
- J. *Integrated Trailer Brake Controller (If Equipped). See Trailer Towing on page 9-73.*
- K. *Dome Lamps on page 6-7.*
- L. *Automatic Transfer Case Control (If Equipped). See Four-Wheel Drive on page 10-28.*
- M. *Data Link Connector (DLC) (Out of View). See Malfunction Indicator Lamp on page 5-21.*
- N. *Hood Release. See Hood on page 10-4.*
- O. *Parking Brake on page 9-51.*
- P. *Cruise Control on page 9-56.*
- Q. *Steering Wheel Adjustment on page 5-2.*
- R. *Horn on page 5-4.*
- S. *Steering Wheel Controls on page 5-2.*
- T. *Climate Control Systems (with Air Conditioning) on page 8-1 or Climate Control Systems (with Heater Only) on page 8-4 (If Equipped).*  
*Dual Automatic Climate Control System on page 8-5 (If Equipped).*
- U. *Power Outlets on page 5-9.*  
*Cigarette Lighter (If Equipped). See Ashtrays on page 5-10 and Cigarette Lighter on page 5-9.*

- V. *StabiliTrak® System on page 9-53 (If Equipped).*  
 Pedal Adjust Button (If Equipped). See *Adjustable Throttle and Brake Pedal on page 9-23.*  
*Ultrasonic Parking Assist on page 9-59 (If Equipped).*  
 Exhaust Brake (If Equipped). See “Brakes” in the Duramax diesel supplement.
- W. Passenger Airbag Off Control (If Equipped). See *Airbag On-Off Switch on page 3-28.*

## Initial Drive Information



This section provides a brief overview about some of the important features that may or may not be on your specific vehicle.

For more detailed information, refer to each of the features which can be found later in this owner manual.



## Remote Keyless Entry (RKE) System

The RKE transmitter is used to remotely lock and unlock the doors from up to 60 m (195 ft) away from the vehicle.



 : Press to unlock the driver door. Press  again within three seconds to unlock all remaining doors.

 : Press to lock all doors. Lock and unlock feedback can be personalized. See *Vehicle Personalization (With DIC Buttons) on page 5-46.*



 : Press and release to locate the vehicle. Press  and hold for more than two seconds to sound the panic alarm. Press  again to cancel the panic alarm.

See *Keys on page 2-1* and *Remote Keyless Entry (RKE) System Operation on page 2-2*.

### Remote Vehicle Start

With this feature the engine can be started from outside of the vehicle.

#### Starting the Vehicle

1. Aim the RKE transmitter at the vehicle.
2. Press and release .
3. Immediately after completing Step 2, press and hold  for at least two seconds or until the turn signal lamps flash.

When the vehicle starts, the parking lamps will turn on and remain on as long as the engine is running. The doors will be locked and the climate control system may come on.

The engine will continue to run for 10 minutes. Repeat the steps for a 10-minute time extension. Remote start can be extended only once.

#### Canceling a Remote Start

To cancel a remote start, do one of the following:

- Aim the RKE transmitter at the vehicle and press and hold  until the parking lamps turn off.
- Turn on the hazard warning flashers.
- Turn the vehicle on and then back off.

See *Remote Vehicle Start on page 2-4*.

### Door Locks

There are several ways to lock and unlock the vehicle.

From outside, use the Remote Keyless Entry (RKE) transmitter or the key in the driver door.

From inside, use the power door locks or the manual door locks. To lock or unlock the door with the manual locks, push down or pull up on the manual lock knob.

## Power Door Locks

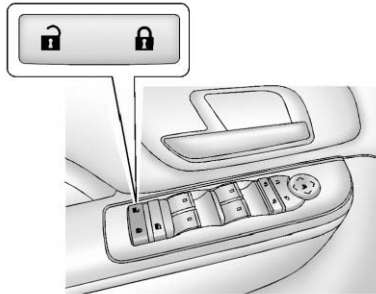

**Crew Cab Premium Trim Shown,  
Uplevel Similar**

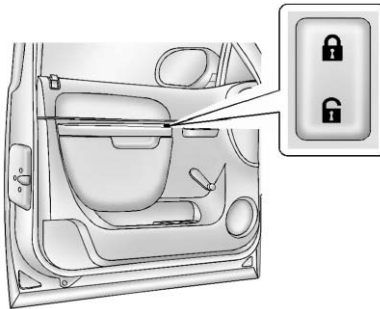

**Base Trim**

For vehicles with power door locks:

 : Press to lock the doors.

 : Press to unlock the doors.

See *Door Locks* on page 2-6 and  
*Power Door Locks* on page 2-7.

## Windows

### Manual Windows

Turn the hand crank on each door to manually raise or lower the manual windows.

## Power Windows

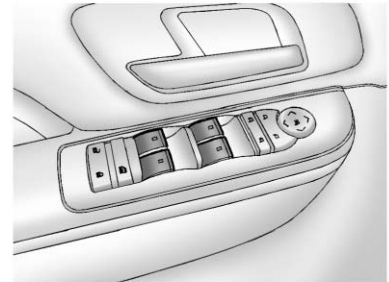

**Crew Cab Premium Trim Shown,  
Other Models Similar**

The driver door has a switch to control all windows. Each passenger door has a switch to control that window. The power windows work when the ignition is in ON/RUN or ACC/ACCESSORY, or Retained Accessory Power (RAP). See *Retained Accessory Power (RAP)* on page 9-27.

## 1-10 In Brief

Press the switch to lower the window. Pull the switch up to raise it. See *Windows on page 2-17* and *Power Windows on page 2-18*.

### Power Sliding Rear Window

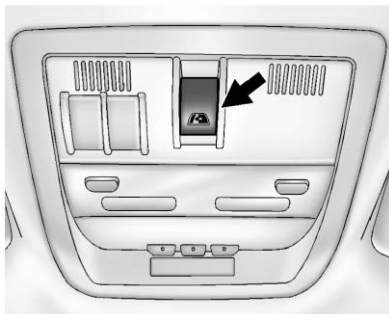

If equipped, the power sliding rear window works when the ignition has been turned to ACC/ACCESSORY or ON/RUN, or when Retained Accessory Power (RAP) is active. See *Retained Accessory Power (RAP) on page 9-27*.

- Press the switch to open the window.

- Pull the switch to close the window.

The power sliding rear window cannot be operated manually.

### Seat Adjustment

#### Manual Seats

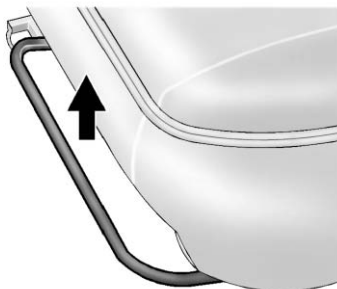

To adjust the seat:

1. Lift the bar to unlock the seat.
2. Slide the seat to the desired position and release the bar.

3. Try to move the seat back and forth to be sure the seat is locked in place.

See *Seat Adjustment on page 3-3*.

#### Power Seats



To adjust a power seat, if equipped:

- Move the seat forward or rearward by sliding the control forward or rearward.
- If available, raise or lower the front or rear part of the seat cushion by moving the front or rear of the control up or down.



- If available, raise or lower the entire seat by moving the entire control up or down.

See *Power Seat Adjustment* on page 3-4.

## Lumbar Adjustment

### Manual Lumbar

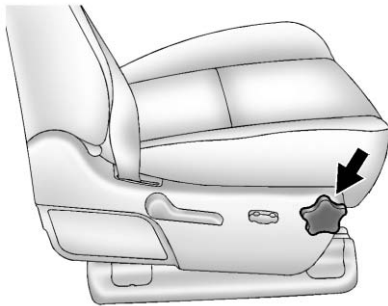

If equipped, increase or decrease manual lumbar support by turning the knob forward or rearward.

See *Lumbar Adjustment* on page 3-4.

### Power Lumbar



To adjust the power lumbar support, if equipped:

- On vehicles with two-way lumbar, press and hold the top or bottom of the control to increase or decrease lumbar support.
- On vehicles with four-way lumbar, press and hold the front or rear of the control to increase or decrease lumbar support. To

raise or lower the height of the support, press and hold the top or bottom of the control.

See *Lumbar Adjustment* on page 3-4.

## Reclining Seatbacks

### Manual Reclining Seatbacks



To recline a manual seatback:

1. Lift the lever.

## 1-12 In Brief

---

2. Move the seatback to the desired position, and then release the lever to lock the seatback in place.
3. Push and pull on the seatback to make sure it is locked.

To return the seatback to the upright position:

1. Lift the lever fully without applying pressure to the seatback, and the seatback will return to the upright position.
2. Push and pull on the seatback to make sure it is locked.

See *Reclining Seatbacks on page 3-5*.

### Power Reclining Seatbacks



To adjust a power seatback, if equipped:

- Tilt the top of the control rearward to recline.
- Tilt the top of the control forward to raise.

See *Reclining Seatbacks on page 3-5*.

### Memory Features

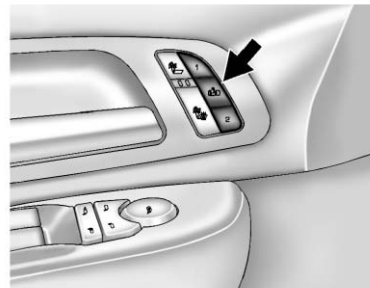

If available, the controls on the driver door are used to program and recall memory settings for the driver seat, outside mirrors, and the adjustable throttle and brake pedals, if equipped.

See *Memory Seats on page 3-6* and *Vehicle Personalization (With DIC Buttons) on page 5-46*.

## Heated and Ventilated Seats

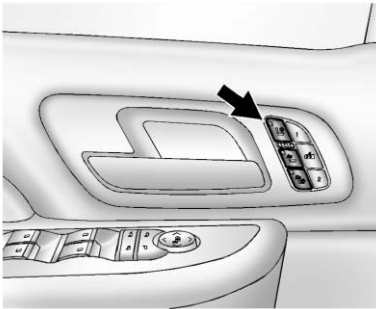

**Heated and Cooled Seat Buttons Shown, Heated Seat Buttons Similar**

If available, the buttons are on the front doors. To operate, the ignition must be in ON/RUN.

 : If available, press to cool the seat.

 : Press to heat the seatback only.

 : Press to heat the seat and seatback.

Press the button once for the highest setting. With each press of the button, the seat will change to the next lower setting, and then to the off setting. The lights indicate three for the highest setting and one for the lowest.

See *Heated and Ventilated Front Seats* on page 3-8.

## Head Restraint Adjustment

Do not drive until the head restraints for all occupants are installed and adjusted properly.

To achieve a comfortable seating position, change the seatback recline angle as little as necessary while keeping the seat and the head restraint height in the proper position.

See *Head Restraints* on page 3-2 and *Seat Adjustment* on page 3-3.

## Safety Belts



Refer to the following sections for important information on how to use safety belts properly.

- *Safety Belts* on page 3-11.
- *How to Wear Safety Belts Properly* on page 3-12.
- *Lap-Shoulder Belt* on page 3-13.
- *Lower Anchors and Tethers for Children (LATCH System)* on page 3-45.

### Passenger Sensing System

The passenger sensing system, if equipped, turns off the front outboard passenger frontal airbag under certain conditions. No other airbag is affected by the passenger sensing system.

If the vehicle has one of the indicators pictured in the following illustrations, then the vehicle has a passenger sensing system for the right front passenger position unless there is an airbag off switch located in the glove box.

If there is an airbag off switch, the vehicle does not have a passenger sensing system. See *Airbag On-Off Switch on page 3-28* for more information.

The passenger airbag status indicator will be visible on the overhead console when the vehicle is started.



United States



Canada and Mexico

See *Passenger Sensing System on page 3-31* for important information.

### Mirror Adjustment

Using hood-mounted air deflectors and add-on convex mirror attachments could decrease mirror performance.

### Exterior Mirrors

#### Power Mirrors

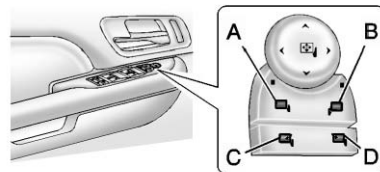

#### Crew Cab Premium Trim with Power Folding Mirrors Shown, Uplevel Similar

1. Press (A) or (B) to select the driver or passenger side mirror.
2. Press the arrows on the control pad to move the mirror up, down, right, or left.

- Adjust each outside mirror so that a little of the vehicle and the area behind it can be seen.
- Press either (A) or (B) again to deselect the mirror.

See *Power Mirrors on page 2-14*.

If the vehicle has power folding mirrors:

- Press (C) to fold the mirrors out to the driving position.
- Press (D) to fold the mirrors in to the folded position.

See *Folding Mirrors on page 2-15*.

The mirrors may also include a memory function that works with the memory seats. See *Memory Seats on page 3-6*.



#### Crew Cab Uplevel Trim without Power Folding Mirrors

- Move the selector switch located above the four-way control pad to the left or right to choose either the driver side or passenger side mirror.
- Press one of the four arrows located on the control pad to move the mirror in the desired direction.
- Adjust each outside mirror so that a little of the vehicle and the area behind it can be seen.

See *Power Mirrors on page 2-14*.

Keep the selector switch in the center position when not adjusting either outside mirror.

#### Manual Mirrors

If the vehicle has manual mirrors, they can be adjusted by moving the mirror up and down or left to right to see a little of the side of the vehicle, and have a clear view behind the vehicle.

#### Manual Folding Mirrors

If the vehicle has manual folding mirrors, push the mirror toward the vehicle. Push the mirror outward, to return to its original position.

Manually fold the mirrors inward to prevent damage when going through an automatic car wash.

See *Folding Mirrors on page 2-15*.

#### Trailer-Tow Mirrors

If the vehicle has towing mirrors, they can be adjusted for a clearer view of the objects behind you.

Manually pull out the mirror head to extend it for better visibility when towing a trailer. See *Trailer-Tow Mirrors on page 2-13*.

### Heated Mirrors

For vehicles with heated mirrors:

Press  to heat the mirrors. If the vehicle has a towing mirror, only the upper glass of the mirror is heated. The lower convex part of the towing mirrors is not heated.

See “Rear Window Defogger” under *Climate Control Systems (with Air Conditioning) on page 8-1* or *Climate Control Systems (with Heater Only) on page 8-4* or *Dual Automatic Climate Control System on page 8-5*.

### Park Tilt Mirrors

If the vehicle has the memory package, the exterior mirrors tilt to a preselected position when the vehicle is in R (Reverse). This feature lets the driver view the curb when parallel parking. The mirrors

return to the original position when the vehicle is shifted out of R (Reverse), or the ignition is turned off or to OFF/LOCK.

This feature can be programmed through the Driver Information Center (DIC). See *Vehicle Personalization (With DIC Buttons) on page 5-46*.

### Interior Mirror

#### Adjustment

Hold the rearview mirror in the center and move it to view the area behind the vehicle.

#### Manual Rearview Mirror

For vehicles with a manual rearview mirror, push the tab forward for daytime use and pull it for nighttime use to avoid glare from the headlamps from behind. See *Manual Rearview Mirror on page 2-16*.

### Automatic Dimming Rearview Mirror

For vehicles with an automatic dimming rearview mirror, the mirror will automatically reduce the glare from the headlamps from behind. The dimming feature comes on when the vehicle is started.

See *Automatic Dimming Rearview Mirror on page 2-17*.

### Steering Wheel Adjustment

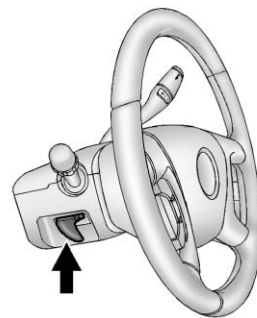

To adjust the steering wheel:

1. Hold the steering wheel and pull the lever.
2. Move the steering wheel up or down.
3. Release the lever to lock the wheel in place.

Do not adjust the steering wheel while driving.

## Throttle and Brake Pedal Adjustment

On vehicles with this feature, you can change the position of the throttle and brake pedals.



The control used to adjust the pedals is located on the instrument panel below the climate control system.

Press the bottom of the control to move the pedals closer to your body. Press the top of the control to move the pedals away.

See *Adjustable Throttle and Brake Pedal* on page 9-23.

## Interior Lighting

### Dome Lamps

The dome lamps are located in the overhead console.

They come on when any door is opened and turn off after all the doors are closed.

Turn the instrument panel brightness knob located below the dome lamp override button, clockwise to the farthest position to manually turn on the dome lamps. The dome lamps remain on until the knob is turned counterclockwise.

### Dome Lamp Override

The dome lamp override button is located next to the exterior lamps control.

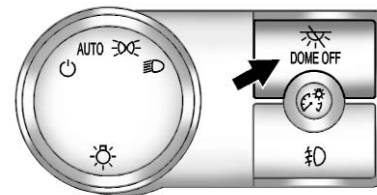

**DOME OFF** : Press the button in and the dome lamps remain off when a door is opened. Press the button again to return it to the extended position so that the dome lamps come on when a door is opened.

### Reading Lamps

For vehicles with reading lamps in the overhead console, press the button located next to the lamp to turn it on or off.

## 1-18 In Brief

The vehicle may also have reading lamps in other locations. The lamps are fixed and cannot be adjusted.

For more information about interior lamps, see:

- *Dome Lamps on page 6-7.*
- *Reading Lamps on page 6-8.*
- *Instrument Panel Illumination Control on page 6-7.*

### Exterior Lighting

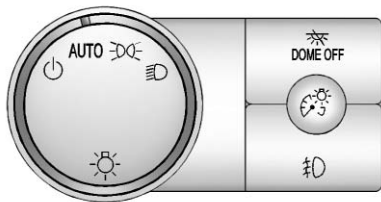

The exterior lamp control is on the instrument panel to the left of the steering wheel.

There are four positions.

 : Turns off the automatic headlamps and Daytime Running Lamps (DRL). Turn the headlamp control to the off position again to turn the automatic headlamps or DRL back on.

For vehicles first sold in Canada, the off position will only work when the vehicle is shifted into P (Park).

**AUTO:** Automatically turns on the headlamps, parking lamps, taillamps, instrument panel lights, roof marker lamps (if equipped), and license plate lamps.

 : Turns on the parking lamps, taillamps, instrument panel lights, roof marker lamps (if equipped), and license plate lamps.

 : Turns on the headlamps, parking lamps, taillamps, instrument panel lights, roof marker lamps (if equipped), and license plate lamps.

See:

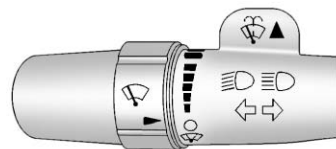

- *Exterior Lamp Controls on page 6-1*
- *Daytime Running Lamps (DRL) on page 6-3*
- *Fog Lamps on page 6-6*

### Windshield Wiper/Washer



The front wiper control is located on the turn and lane-change lever.

The windshield wipers are controlled by turning the band with  on it.

 : For a single wipe, turn to  , then release. For several wipes, hold the band on  longer.



○ : Turns the windshield wipers off.

↑ : Turn the band up for more frequent wipes or down for less frequent wipes.

■ : Slow wipes.

● : Fast wipes.

☒ : Push the paddle at the top of the lever to spray washer fluid on the windshield.

See *Windshield Wiper/Washer* on page 5-4.

## Climate Controls

These systems control the heating, cooling, and ventilation.

### Climate Control System (With Air Conditioning)

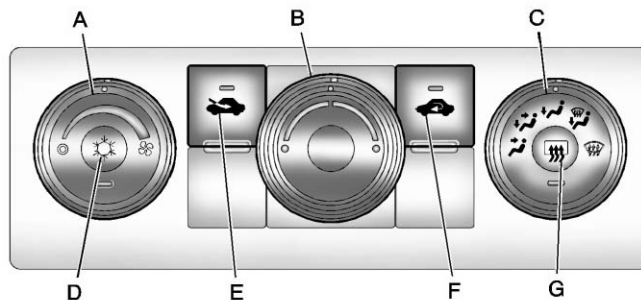

- |                              |                         |
|------------------------------|-------------------------|
| A. Fan Control               | E. Outside Air          |
| B. Temperature Control       | F. Air Recirculation    |
| C. Air Delivery Mode Control | G. Rear Window Defogger |
| D. Air Conditioning          |                         |

**Climate Control System (With Heater Only)**

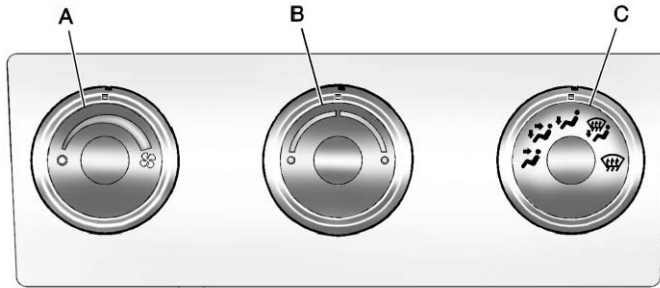

- A. Fan Control
- B. Temperature Control
- C. Air Delivery Mode Control

See *Climate Control Systems (with Air Conditioning)* on page 8-1 or *Climate Control Systems (with Heater Only)* on page 8-4.

## Dual Automatic Climate Control System

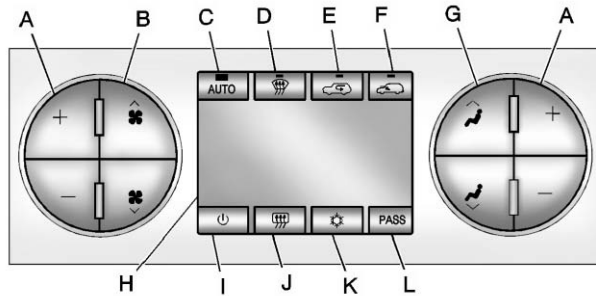

- |   |  |
|---|--|
| <ul style="list-style-type: none"> <li>A. Driver and Passenger Temperature Controls</li> <li>B. Fan Control</li> <li>C. AUTO</li> <li>D. Defrost</li> <li>E. Air Recirculation</li> <li>F. Outside Air</li> <li>G. Air Delivery Mode Control</li> <li>H. Display</li> </ul> | <ul style="list-style-type: none"> <li>I. Power Button</li> <li>J. Rear Window Defogger</li> <li>K. Air Conditioning</li> <li>L. PASS (Passenger)</li> </ul> <p>See <i>Climate Control Systems (with Air Conditioning)</i> on page 8-1 or <i>Climate Control Systems (with Heater Only)</i> on page 8-4 or <i>Dual Automatic Climate Control System</i> on page 8-5 (If Equipped).</p> |
|---|--|

## Transmission

### Range Selection Mode

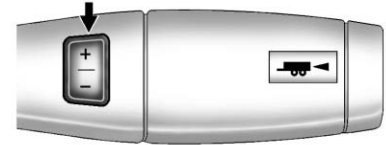

The Range Selection Mode switch, if equipped, is located on the shift lever.

To enable the Range Selection feature:

1. Move the column shift lever to the M (Manual) position. The current range will appear next to the M. This is the highest attainable range with all lower gears accessible. As an example, when 5 (Fifth) gear is selected, 1 (First) through 5 (Fifth) gears are available.

## 1-22 In Brief

---

2. Press the plus/minus buttons, located on the steering column shift lever, to select the desired range of gears for current driving conditions. See *Manual Mode* on page 9-36.

While using Range Selection Mode, cruise control and the Tow/Haul mode can be used.

Grade Braking is not available when Range Selection Mode is active. See *Tow/Haul Mode* on page 9-37.

### Four-Wheel Drive

If the vehicle has Four-Wheel Drive, you can send the engine's driving power to all four wheels for extra traction.

### Transfer Case Buttons

The vehicle will have one of these three styles of transfer case controls. Use these controls to shift into and out of the different Four-Wheel Drive modes.

### Manual Transfer Case

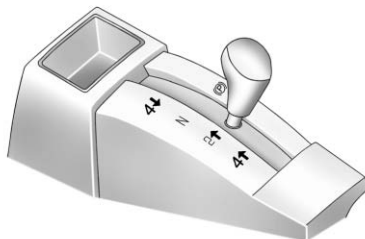

This transfer case shift lever is on the floor to the right of the driver.

### Electronic Transfer Case

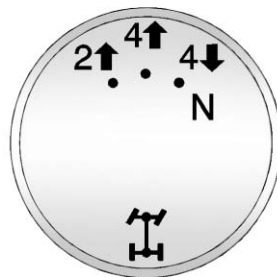

This transfer case knob is located next to the steering column.

## Automatic Transfer Case



This transfer case knob is located next to the steering column.

Each transfer case design offers different drive options. The list below describes the different drive options that may be available.

**2 ↑ (Two-Wheel-Drive High):** This setting is used for driving in most street and highway situations.

**AUTO (Automatic Four-Wheel Drive):** This setting is ideal for use when road surface traction conditions are variable.

**4 ↑ (Four-Wheel High):** Use the Four-Wheel-Drive High position when extra traction is needed, such as on snowy or icy roads or in most off-road situations.

**N (Neutral):** Shift the transfer case to Neutral only when towing the vehicle. See *Recreational Vehicle Towing* on page 10-87 or *Trailer Towing* on page 9-73.

**4 ↓ (Four-Wheel-Drive Low):** This setting sends maximum power to all four wheels. You might choose Four-Wheel-Drive Low if you are driving off-road in deep sand, deep mud, deep snow, and while climbing or descending steep hills.

See *Four-Wheel Drive* on page 9-38.

## Vehicle Features

### Radio(s)



**Radio with USB, CD, and DVD (MP3)**

: Press to turn the system on and off. Turn to increase or decrease the volume.

**BAND**: Press to choose between FM, AM, or SiriusXM<sup>®</sup>, if equipped.

: Turn to manually select radio stations or press to set the bass or treble.

 **SEEK** or  **SEEK**: Seek or scan stations.

: Press to switch the display between the radio station frequency and the time. While the ignition is off, press this button to display the time. Press to display additional text information related to the current FM-RDS or SiriusXM station; or CD, MP3, or WMA song. If information is available during SiriusXM, CD, MP3, or WMA playback, the song title information displays on the top line of the display and artist information displays on the bottom line. When information is not available, "NO INFO" displays.

For more information about these and other radio features, see *Operation on page 7-7*.

For vehicles with a Rear Seat Entertainment System (RSE) and Rear Seat Audio System (RSA), see *Rear Seat Entertainment (RSE) System on page 7-38* and *Rear Seat Audio (RSA) System on page 7-47* for more information.



### Storing Radio Stations

A maximum of 36 stations can be stored as favorites using the six softkeys located below the radio station frequency tabs and by using the radio FAV button. Press FAV to go through up to six pages of favorites, each having six favorite stations available per page. Each page of favorites can contain any combination of AM, FM, or SiriusXM stations.

For more information, see “Storing Radio Stations” in *AM-FM Radio on page 7-10*.

### Setting the Clock

To set the time and date:

1. Turn the ignition key to ACC/ACCESSORY or ON/RUN, then press  , to turn the radio on.
2. Press  to display HR, MIN, MM, DD, and YYYY (hour, minute, month, day, and year).
3. Press the softkey located under any one of the labels to be changed.
4. To increase or decrease the time or date, turn  clockwise or counter-clockwise.

For detailed instructions on setting the clock for the vehicle’s specific audio system, see *Clock on page 5-7*.

### Satellite Radio

SiriusXM<sup>®</sup> is a satellite radio service based in the 48 contiguous United States and 10 Canadian provinces. SiriusXM satellite radio has a wide

variety of programming and commercial-free music, coast to coast, and in digital-quality sound.

A fee is required to receive the SiriusXM service.

For more information, refer to:

- [www.siriusxm.com](http://www.siriusxm.com) or call 1-866-635-2349 (U.S.)
- [www.xmradio.ca](http://www.xmradio.ca) or call 1-877-209-0079 (Canada)

See *Satellite Radio on page 7-12*.

### Portable Audio Devices

This vehicle may have an auxiliary input located on the radio faceplate and a USB port located in the center console or on the instrument panel. External devices such as an iPod<sup>®</sup>, laptop computer, MP3 player, CD changer, or USB storage device can be connected to the auxiliary port using a 3.5 mm (1/8 in) input cable or the USB port depending on the audio system.

See “Using the Auxiliary Input Jack” and “Using the USB Port” in *Auxiliary Devices on page 7-33*.

## Bluetooth®

For vehicles with a Bluetooth system, it allows users with a Bluetooth-enabled cell phone to make and receive hands-free calls using the vehicle’s audio system and controls.

The Bluetooth-enabled cell phone must be paired with the Bluetooth system before it can be used in the vehicle. Not all phones will support all functions. For more information, see [www.gm.com/bluetooth](http://www.gm.com/bluetooth) and *Bluetooth on page 7-49*.

## Steering Wheel Controls

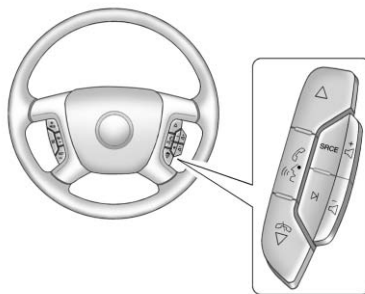

If available, some audio controls can be adjusted at the steering wheel.

**△** : Press to go to the next favorite radio station, track on a CD, or folder on an iPod® or USB device.

**◁ / ▽** : Press to go to the previous favorite radio station, track on a CD, or folder on an iPod® or USB device. Press to reject an incoming call, or to end a call.

**🔇 / 🔊** : Press to silence the vehicle speakers only. Press again to turn the sound on. Press and hold longer than two seconds to interact with OnStar® or Bluetooth systems, if equipped.

**+ 🔊** : Press to increase volume.

**- 🔊** : Press to decrease volume.

**SRCE**: Press to switch between the radio and CD, and for equipped vehicles, the DVD, front auxiliary, and rear auxiliary.

**▷** : Press to seek the next radio station, the next track or chapter while sourced to the CD or DVD slot, or to select tracks and folders on an iPod or USB device.

For more information, see *Steering Wheel Controls on page 5-2*.



## Cruise Control

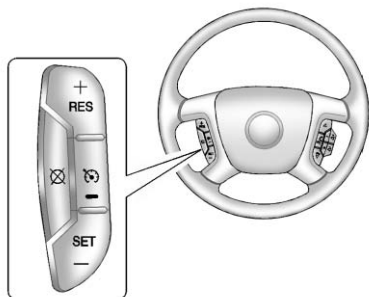

 : Press to turn the system on or off. The indicator light is on when cruise control is on and turns off when cruise control is off.

**+ RES:** Press briefly to make the vehicle resume to a previously set speed, or press and hold to accelerate.

**SET -:** Press to set the speed and activate cruise control or make the vehicle decelerate.

 : Press to disengage cruise control without erasing the set speed from memory.

See *Cruise Control* on page 9-56.

## Navigation System

If the vehicle has a navigation system, there is a separate navigation manual that includes information on the radio, audio players, and navigation system.

The navigation system provides detailed maps of most major freeways and roads. After a destination has been set, the system provides turn-by-turn instructions for reaching the destination. In addition, the system can help locate a variety of points of interest (POIs), such as banks, airports, restaurants, and more.

See the navigation manual for more information.

## Driver Information Center (DIC)

The DIC display is at the bottom of the instrument cluster. It shows the status of many vehicle systems and enables access to the personalization menu.



The DIC buttons are on the instrument panel, next to the steering wheel.

Some vehicles do not have the buttons shown, however some of the menus can be viewed by using the trip odometer reset stem.

 : Press to display the odometer, trip odometer, fuel range, average economy, fuel used, timer, instantaneous economy and Active Fuel Management® indicator, and transmission temperature. The compass and outside air temperature will also be shown in the display. The temperature will be shown in °C or °F depending on the units selected.

 : Press to display the oil life, units, tire pressure readings for vehicles with the Tire Pressure Monitor System (TPMS), trailer brake gain and output information for vehicles with the Integrated Trailer Brake Control (ITBC) system, engine hours, compass zone setting, and compass recalibration.

 : Press to customize the feature settings on your vehicle. See *Vehicle Personalization (With DIC Buttons)* on page 5-46 for more information.

✓ : Press to set or reset certain functions and to turn off or acknowledge messages on the DIC.

For more information, see *Driver Information Center (DIC) on page 5-28*.

### Vehicle Customization

Some vehicle features can be programmed by using the DIC buttons next to the steering wheel. These features include:

- Language
- Door Lock and Unlock Settings
- RKE Lock and Unlock Feedback
- Lighting
- Chime Volume
- Memory Features

See *Vehicle Personalization (With DIC Buttons)* on page 5-46.

### Rear Vision Camera (RVC)

If available, the RVC displays a view of the area behind the vehicle when the vehicle is shifted into R (Reverse). This is displayed on the inside rearview mirror or the navigation screen, if equipped.

To clean the camera lens, near the tailgate handle, rinse it with water and wipe it with a soft cloth.

For more information, see *Rear Vision Camera (RVC)* on page 9-60.

### Ultrasonic Parking Assist

If available, this system uses sensors on the rear bumper to assist with parking and avoiding objects while in R (Reverse). It operates at speeds less than 8 km/h (5 mph). URPA uses audible beeps to provide distance and system information.

Keep the sensors on the vehicle's rear bumper clean to ensure proper operation.

See *Ultrasonic Parking Assist* on page 9-59.

## Power Outlets

Accessory power outlets can be used to plug in electrical equipment, such as a cell phone, MP3 player, etc.

The vehicle may have two accessory power outlets located below the climate control system, or may have one accessory power outlet and one cigarette lighter. The cigarette lighter is designed to fit only in the receptacle closest to the driver.

There may be another accessory power outlet in the rear cargo area. If the vehicle has a floor console, there is an accessory power outlet inside the storage bin and one on the rear of the floor console.

The accessory power outlets are powered, even when the ignition is in LOCK/OFF. Continuing to use

power outlets while the ignition is in LOCK/OFF may cause the vehicle's battery to run down.

See *Power Outlets* on page 5-9.

## Universal Remote System



Vehicles with the Universal Remote System will have these buttons located in the headliner.

This system provides a way to replace up to three remote control transmitters used to activate devices such as garage door openers, security systems, and home automation devices.

Read the instructions completely before attempting to program the transmitter. Because of the steps

involved, it may be helpful to have another person assist with programming the transmitter.

See *Universal Remote System* on page 5-54.

## Sunroof

### Extended Cab

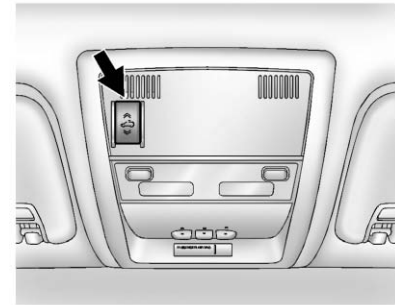

On vehicles with a sunroof, the sunroof only operates when the ignition is in ACC/ACCESSORY or ON/RUN, or when Retained

Accessory Power (RAP) is active. See *Retained Accessory Power (RAP)* on page 9-27.

**Vent:** From the closed position, press and hold the rear of the switch to vent the sunroof. To close the sunroof, press and hold the front of the switch.

**Open:** From the vent position, the sunroof can be fully opened either manually or by using the express-open feature. To open manually, press the rear of the switch to the first detent and hold until the sunroof has reached the desired position. To open using express-open, press the rear of the switch to the second detent and release. The sunroof will move to the full open position. To stop the sunroof partway, press the switch a second time.

**Close:** From the vent, or open position, press and hold the front of the switch to close the sunroof.

The sunroof also has a roller sunshade that can be used to block the rays of the sun. To open the sunshade, press and unlatch it, and roll it back. To close, pull it forward and latch it into the closed position.

See *Sunroof (Crew Cab)* on page 2-21 or *Sunroof (Extended Cab)* on page 2-20.

### Crew Cab

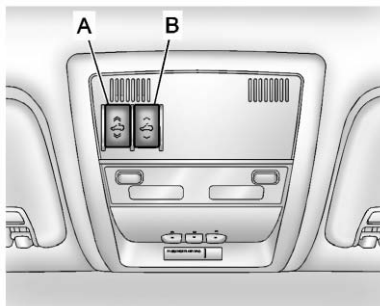

- A. Open or Close
- B. Vent

On vehicles with a sunroof, the sunroof only operates when the ignition is in ACC/ACCESSORY or ON/RUN, or when Retained Accessory Power (RAP) is active. See *Retained Accessory Power (RAP)* on page 9-27.

**Vent:** From the closed position, press the rear of the passenger side switch (B) to vent the sunroof.

**Manual-Open/Manual-Close:** To open the sunroof, press and hold the rear of the driver side switch (A) until the sunroof reaches the desired position. Press and hold the front of the driver side switch to close it.

**Express-Open/Express-Close:** To express-open the sunroof, fully press and release the rear of the driver side switch (A) until the sunroof reaches the desired position. To express-close the sunroof, fully press and release the front of the driver side switch. Press the switch again to stop it.

When the sunroof is opened, an air deflector will automatically raise. The air deflector will retract when the sunroof is closed.

The sunroof also has a sunshade that you can pull forward to block the rays of the sun. The sunshade must be opened and closed manually.



If an object is in the path of the sunroof while it is closing, the anti-pinch feature will detect the object and stop the sunroof.

See *Sunroof (Crew Cab)* on page 2-21 or *Sunroof (Extended Cab)* on page 2-20.

## Performance and Maintenance

### StabiliTrak<sup>®</sup> System

If equipped, the vehicle has a traction control system that limits wheel spin and the StabiliTrak system that assists with directional control of the vehicle in difficult driving conditions. Both systems turn on automatically every time the vehicle is started.

- To turn off traction control, press and release  on the instrument panel. The appropriate DIC message displays. See *Ride Control System Messages* on page 5-42.
- To turn off both traction control and StabiliTrak, press and hold  until  illuminates and the appropriate DIC message displays. See *Ride Control System Messages* on page 5-42.

- Press and release  again to turn on both systems.

For more information, see *StabiliTrak<sup>®</sup> System* on page 9-53.

### Tire Pressure Monitor

This vehicle may have a Tire Pressure Monitor System (TPMS).



The low tire pressure warning light alerts to a significant loss in pressure of one of the vehicle's tires. If the warning light comes on, stop as soon as possible and inflate the tires to the recommended pressure shown on the Tire and Loading Information label. See *Vehicle Load Limits* on page 9-15. The warning light will remain on until the tire pressure is corrected.

The low tire pressure warning light may come on in cool weather when the vehicle is first started, and then turn off as the vehicle is driven. This may be an early indicator that the tire pressures are getting low and the tires need to be inflated to the proper pressure.

The TPMS does not replace normal monthly tire maintenance. Maintain the correct tire pressures.

See *Tire Pressure Monitor System* on page 10-57.

### Engine Oil Life System

The engine oil life system calculates engine oil life based on vehicle use and, on most vehicles, displays a DIC message when it is necessary to change the engine oil and filter. The oil life system should be reset to 100% only following an oil change.

#### Resetting the Oil Life System

To reset the Engine Oil Life System on most vehicles:

1. Display OIL LIFE REMAINING on the DIC. If the vehicle does not have DIC buttons, the vehicle must be in P (Park) to access this display.
2. Press and hold the SET/RESET button on the DIC, or the trip odometer reset stem if the vehicle does not have DIC buttons, for more than five seconds. The oil life will change to 100%.

On all vehicles, the Engine Oil Life System can be reset as follows:

1. Turn the ignition to ON/RUN with the engine off.
2. Fully press the accelerator pedal slowly three times within five seconds.

3. Display OIL LIFE REMAINING on the DIC. If the display shows 100%, the system is reset.

See *Engine Oil Life System* on page 10-9.

### Fuel E85 (85% Ethanol)

Vehicles that have a yellow fuel cap can use either unleaded gasoline or ethanol fuel containing up to 85% ethanol (E85). See *Fuel E85 (85% Ethanol)* on page 9-68. For all other vehicles, use only the unleaded gasoline described under *Recommended Fuel* on page 9-66.

## Driving for Better Fuel Economy

Driving habits can affect fuel mileage. Here are some driving tips to get the best fuel economy possible.

- Avoid fast starts and accelerate smoothly.
- Brake gradually and avoid abrupt stops.
- Avoid idling the engine for long periods of time.
- When road and weather conditions are appropriate, use cruise control.
- Always follow posted speed limits or drive more slowly when conditions require.
- Keep vehicle tires properly inflated.
- Combine several trips into a single trip.

- Replace the vehicle's tires with the same TPC Spec number molded into the tire's sidewall near the size.
- Follow recommended scheduled maintenance.

## Roadside Assistance Program

U.S.: 1-888-881-3302

TTY Users (U.S. Only):  
1-888-889-2438

Canada: 1-800-268-6800

Mexico: 01-800-466-0801

As the owner of a new GMC, you are automatically enrolled in the Roadside Assistance program.

See *Roadside Assistance Program (Mexico)* on page 13-7 or *Roadside Assistance Program (U.S. and Canada)* on page 13-11.

## Roadside Assistance and OnStar (U.S. and Canada)

If the vehicle has an active OnStar subscription, contact OnStar and the vehicle's current GPS location will be sent to an OnStar advisor to assess the situation, contact Roadside Assistance, and relay the exact location to send help.

## OnStar®

If equipped, this vehicle has a comprehensive, in-vehicle system that can connect to a live Advisor for Emergency, Security, Navigation, Connection, and Diagnostic Services. See *OnStar Overview* on page 14-1.





# Keys, Doors, and Windows

## Keys and Locks

- Keys ..... 2-1
- Remote Keyless Entry (RKE) System ..... 2-2
- Remote Keyless Entry (RKE) System Operation ..... 2-2
- Remote Vehicle Start ..... 2-4
- Door Locks ..... 2-6
- Power Door Locks ..... 2-7
- Delayed Locking ..... 2-7
- Automatic Door Locks ..... 2-7
- Lockout Protection ..... 2-8
- Safety Locks ..... 2-8

## Doors

- Rear Doors (Extended Cab) ..... 2-8
- Tailgate ..... 2-9

## Vehicle Security

- Vehicle Security ..... 2-10
- Vehicle Alarm System ..... 2-10
- Immobilizer ..... 2-11
- Immobilizer Operation ..... 2-11

## Exterior Mirrors

- Convex Mirrors ..... 2-13
- Manual Mirrors ..... 2-13
- Trailer-Tow Mirrors ..... 2-13
- Power Mirrors ..... 2-14
- Folding Mirrors ..... 2-15
- Heated Mirrors ..... 2-16
- Park Tilt Mirrors ..... 2-16

## Interior Mirrors

- Manual Rearview Mirror ..... 2-16
- Automatic Dimming Rearview Mirror ..... 2-17

## Windows

- Windows ..... 2-17
- Manual Windows ..... 2-18
- Power Windows ..... 2-18
- Rear Windows ..... 2-19
- Sun Visors ..... 2-19

## Roof

- Sunroof (Extended Cab) ..... 2-20
- Sunroof (Crew Cab) ..... 2-21

# Keys and Locks

## Keys

**⚠ WARNING**

Leaving children in a vehicle with the ignition key is dangerous and children or others could be seriously injured or killed. They could operate the power windows or other controls or make the vehicle move. The windows will function with the keys in the ignition, and children or others could be caught in the path of a closing window. Do not leave children in a vehicle with the ignition key.

## 2-2 Keys, Doors, and Windows



The key is used for the ignition and all door locks.

The key has a bar-coded key tag that the dealer or qualified locksmith can use to make new keys. Store this information in a safe place, not in the vehicle.

See your dealer if a replacement key or additional key is needed.

If the vehicle has an ignition and it becomes difficult to turn the key, inspect the key blade for debris. Periodically clean with a brush or pick.

With an active OnStar subscription, an OnStar Advisor may remotely unlock the vehicle. See *OnStar Overview on page 14-1*.

### Remote Keyless Entry (RKE) System

See *Radio Frequency Statement on page 13-20* for information regarding Part 15 of the Federal Communications Commission (FCC) rules and Industry Canada Standards RSS-GEN/210/220/310.

If there is a decrease in the RKE operating range:

- Check the distance. The transmitter may be too far from the vehicle.

- Check the location. Other vehicles or objects may be blocking the signal.
- Check the transmitter's battery. See "Battery Replacement" later in this section.
- If the transmitter is still not working correctly, see your dealer or a qualified technician for service.

### Remote Keyless Entry (RKE) System Operation

The Remote Keyless Entry (RKE) transmitter functions work up to 60 m (195 ft) away from the vehicle.

There are other conditions which can affect the performance of the transmitter. See *Remote Keyless Entry (RKE) System on page 2-2*.



**With Remote Start (without Remote Start Similar)**

**⤿ (Remote Vehicle Start):** For vehicles with this feature, press ⤿ to start the engine from outside the vehicle using the RKE transmitter. See *Remote Vehicle Start* on page 2-4 for additional information.

**🔒 (Lock):** Press to lock all the doors.

If enabled through the Driver Information Center (DIC), the turn signal lamps flash once to indicate locking has occurred. If enabled through the DIC, the horn chirps when 🔒 is pressed again within three seconds. See *Vehicle Personalization (With DIC Buttons)* on page 5-46 for additional information.

Pressing 🔒 arms the content theft-deterrent system. See *Vehicle Alarm System* on page 2-10.

**🔓 (Unlock):** Press once to unlock only the driver door. If 🔓 is pressed again within three seconds, all remaining doors unlock. The interior lamps may come on and stay on for 20 seconds or until the ignition is turned on.

If enabled through the DIC, the turn signal lamps flash twice to indicate unlocking has occurred. See *Vehicle Personalization (With DIC Buttons)* on page 5-46. If enabled through the DIC, the exterior lights may turn on.

See “Approach Lighting” under *Vehicle Personalization (With DIC Buttons)* on page 5-46.

Pressing 🔒 on the RKE transmitter disarms the content theft-deterrent system. See *Vehicle Alarm System* on page 2-10.

**🚨 (Vehicle Locator/Panic Alarm):**

Press and release to locate the vehicle. The turn signal lamps flash and the horn sounds three times.

Press and hold 🚨 for more than two seconds to activate the panic alarm. The turn signal lamps flash and the horn sounds repeatedly for 30 seconds. The alarm turns off when the ignition is moved to ON/RUN or 🚨 is pressed again. The ignition must be in LOCK/OFF for the panic alarm to work.

## 2-4 Keys, Doors, and Windows

---

### Programming Transmitters to the Vehicle

Only RKE transmitters programmed to this vehicle will work. If a transmitter is lost or stolen, a replacement can be purchased and programmed through your dealer. When the replacement transmitter is programmed to this vehicle, all remaining transmitters must also be reprogrammed. Any lost or stolen transmitters will no longer work once the new transmitter is programmed. Each vehicle can have up to eight transmitters programmed to it. See your dealer for transmitter programming.

### Battery Replacement

Replace the battery if the REPLACE BATTERY IN REMOTE KEY message displays in the DIC.

**Notice:** When replacing the battery, do not touch any of the circuitry on the transmitter. Static from your body could damage the transmitter.

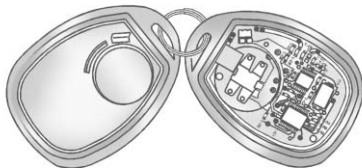

To replace the battery:

1. Separate the transmitter with a flat, thin object, such as a flat head screwdriver.
  - Carefully insert the tool into the notch located along the parting line of the transmitter. Do not insert the tool too far. Stop as soon as resistance is felt.
  - Twist the tool until the transmitter is separated.
2. Remove the old battery. Do not use a metal object.

3. Insert the new battery, positive side facing down. Replace with a CR2032 or equivalent battery.
4. Snap the transmitter back together.

### Remote Vehicle Start

If available, this feature allows you to start the engine from outside of the vehicle. It may also start up the vehicle's heating or air conditioning systems and rear window defogger. Normal operation of the system will return after the key is turned to the ON/RUN position.

If the vehicle has an automatic climate control system, the climate control system will default to a heating or cooling mode depending on the outside temperatures. If the vehicle does not have an automatic climate control system, the system will turn on at the setting the vehicle was set to when the vehicle was last turned off.

During a remote start, if the vehicle has an automatic climate control system and heated seats, the heated seats will turn on during colder outside temperatures and will shut off when the key is turned to ON/RUN. If the vehicle does not have an automatic climate control system, during remote start, manually turn the heated seats on and off. See *Heated and Ventilated Front Seats* on page 3-8 for additional information.

Laws in some communities may restrict the use of remote starters. For example, some laws may require a person using the remote start to have the vehicle in view when doing so. Check local regulations for any requirements on remote starting of vehicles.



Do not use the remote start feature if the vehicle is low on fuel. The vehicle may run out of fuel.

The RKE transmitter range may be less while the vehicle is running.

There are other conditions which can affect the performance of the transmitter. See *Remote Keyless Entry (RKE) System* on page 2-2 for additional information.

**Ⓚ (Remote Start):** This button will be on the RKE transmitter if the vehicle has remote start.

To start the vehicle using the remote start feature:

1. Aim the RKE transmitter at the vehicle.
2. Press and release .
3. Immediately press and hold  until the turn signal lamps flash. If you cannot see the vehicle's lamps, press and hold  for at least two seconds.

When the vehicle starts, the parking lamps will turn on and remain on while the vehicle is running. The doors will be locked and the climate control system may come on.

The engine will continue to run for 10 minutes. Repeat the steps for a 10-minute time extension. Remote start can be extended only once.

After entering the vehicle during a remote start, insert and turn the key to ON/RUN to drive the vehicle.



To cancel a remote start:

- Aim the RKE transmitter at the vehicle and press and hold  until the parking lamps turn off.
- Turn on the hazard warning flashers.
- Turn the ignition on and then back off.

The vehicle can be remote started two separate times between driving sequences. The engine will run for 10 minutes after each remote start.

Or, you can extend the engine run time by another 10 minutes within the first 10 minute remote start time frame, and before the engine stops.

## 2-6 Keys, Doors, and Windows

For example, if  and then  are pressed again after the vehicle has been running for five minutes, 10 minutes are added, allowing the engine to run for 15 minutes.

The additional 10 minutes are considered a second remote vehicle start.

Once two remote starts, or a single remote start with one time extension has been done, the vehicle must be started with the key. After the key is removed from the ignition, the vehicle can be remote started again.

The vehicle cannot be remote started if the key is in the ignition, the hood is not closed, or if there is an emission control system malfunction and the check engine light is on.

Also, the engine will turn off during a remote vehicle start if the coolant temperature gets too high or if the oil pressure gets low.

### Remote Start Ready

If the vehicle does not have the remote vehicle start feature, it may have the remote start ready feature. This feature allows your dealer to add the manufacturer's remote vehicle start feature.

See your dealer to add the manufacturer's remote vehicle start feature to the vehicle.

### Door Locks

#### WARNING

Unlocked doors can be dangerous.

- Passengers, especially children, can easily open the doors and fall out of a moving vehicle. When a door is locked, the handle will not open it. The chance of being thrown out of the vehicle in a crash is increased if the

(Continued)

#### WARNING (Continued)

doors are not locked. So, all passengers should wear safety belts properly and the doors should be locked whenever the vehicle is driven.

- Young children who get into unlocked vehicles may be unable to get out. A child can be overcome by extreme heat and can suffer permanent injuries or even death from heat stroke. Always lock the vehicle whenever leaving it.
- Outsiders can easily enter through an unlocked door when you slow down or stop the vehicle. Locking the doors can help prevent this from happening.

There are several ways to lock and unlock the vehicle.

From outside, use the Remote Keyless Entry (RKE) transmitter or the key in the driver door.

From inside, use the power door locks or manual door locks. To lock or unlock the door with the manual locks, push down or pull up on the manual lock knob.

### Power Door Locks

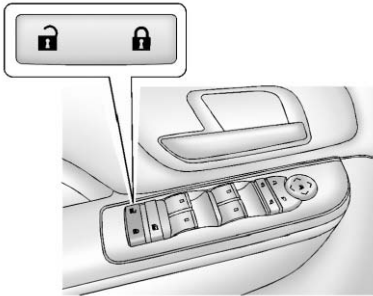

Crew Cab Premium Trim Shown,  
Up-Level Similar

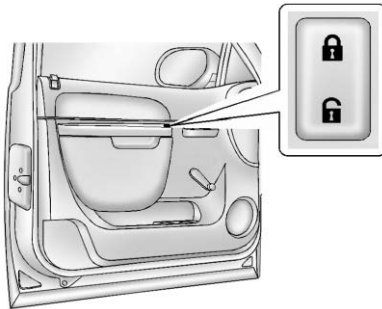

Base Trim

For vehicles with power door locks:

 : Press to lock the doors.

 : Press to unlock the doors.

### Delayed Locking

The vehicle may have the delayed locking feature. When locking the doors with the power lock switch and a door is open, the doors will lock five seconds after the last door is closed. You will hear three chimes to signal that the delayed locking feature is in use.

Pressing the power lock switch twice will override the delayed locking feature and immediately lock all the doors.

This feature will not operate if the key is in the ignition.

This feature can be programmed using the Driver Information Center (DIC). See “Delay Door Lock” under *Vehicle Personalization (With DIC Buttons)* on page 5-46.

### Automatic Door Locks

The vehicle may have an automatic lock/unlock feature. This feature can be programmed using the Driver Information Center (DIC). See *Vehicle Personalization (With DIC Buttons)* on page 5-46.

### Lockout Protection

If the driver side power door lock switch is pressed when the driver door is open and the key is in the ignition, all of the doors will lock and then the driver door will unlock.

If the passenger side power door lock switch is pressed when the front passenger door is open and the key is in the ignition, all of the doors will lock and then the front passenger door will unlock.

### Safety Locks

The vehicle has rear door security locks to prevent passengers from opening the rear doors from the inside.

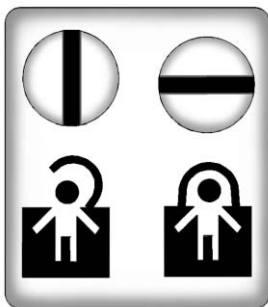

Open the rear doors to access the security locks on the inside edge of each door.

To set the locks, insert a key into the slot and turn it to the horizontal position. The door can only be opened from the outside with the door unlocked. To return the door to normal operation, turn the slot to the vertical position.

### Doors

#### Rear Doors (Extended Cab)

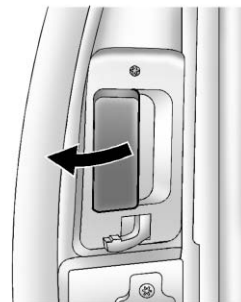

To open a rear access door from the outside, first open the front door. Then, use the handle located on the front edge of the rear access door to open it.

The rear access door must be closed before the front door can close.



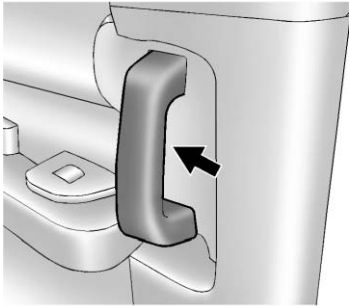

To open a rear access door from the inside, first open the front door. Then, use the handle located on the inside of the rear access door to open.

### Tailgate

**⚠ WARNING**

It is extremely dangerous to ride on the tailgate, even when the vehicle is operated at low speeds. People riding on the tailgate can

(Continued)

**WARNING (Continued)**

easily lose their balance and fall in response to vehicle maneuvers. Falling from a moving vehicle may result in serious injuries or death. Do not allow people to ride on the tailgate. Be sure everyone in your vehicle is in a seat and using a safety belt properly.

On vehicles with a lock on the tailgate, use the key to lock or unlock the tailgate.

Open the tailgate by lifting up on its handle while pulling the tailgate down.

To shut the tailgate, firmly push it upward until it latches.

After closing the tailgate, pull it back to be sure it latches securely.

### Tailgate Removal

The tailgate can be removed to allow for different loading situations. Assistance may be needed with the removal to avoid damage to the vehicle.

On vehicles with a Rear Vision Camera, it must be disconnected before removing the tailgate. See *Rear Vision Camera (RVC)* on page 9-60.

To remove the tailgate:

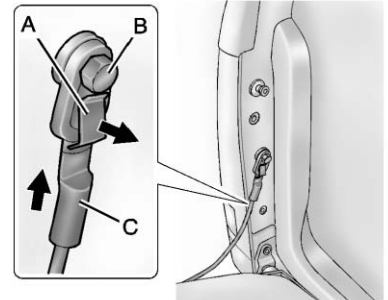

## 2-10 Keys, Doors, and Windows

---

1. Raise the tailgate slightly, pull out and hold the cable retaining clip (A). Push the cable (C) up and off of the bolt (B). Repeat on the other side.
2. With the tailgate about halfway open, lift the right edge of the tailgate from the lower pivot.  
On vehicles with the tailgate assist feature, raise the tailgate nearly all the way to the closed position prior to removing the left edge.
3. Move the tailgate to the right to release the left edge.

Reverse this procedure to reinstall the tailgate. Make sure the tailgate is secure.

### Vehicle Security

This vehicle has theft-deterrent features; however, they do not make the vehicle impossible to steal.

### Vehicle Alarm System

This vehicle may have a content theft-deterrent alarm system.



This is the security light.

To arm the theft-deterrent system:

1. Open the door.

2. Lock the door with the Remote Keyless Entry (RKE) transmitter. The security light should flash.

If the delayed locking feature is active, the alarm will not be activated until all doors are closed and the security light goes off.

3. Close all doors. The security light will stop flashing and go off after approximately 30 seconds. The system is armed when the security light goes off.

If a locked driver door is opened without using the RKE transmitter, a 10 second pre-alarm will occur. The horn will chirp and the lights will flash. If the key is not placed in the ignition and turned to START or the door is not unlocked by pressing the unlock button on the RKE transmitter during the 10 second pre-alarm, the alarm will go off. The vehicle's headlamps will flash and the horn will sound for about 30 seconds, then will turn off to save the battery power.

The theft-deterrent system will not activate if the doors are locked with the key or the manual door lock. It activates only if you use the power door lock switch or the RKE transmitter. The vehicle can be started with the correct key if the alarm is set off.

To avoid setting off the alarm by accident:

- If you do not want to activate the theft-deterrent system, the vehicle should be locked with the door key after the doors are closed.
- Always unlock a door with the RKE transmitter.

If the alarm is set off, press unlock on the RKE transmitter or place the key in the ignition and turn it to START.

### Testing the Alarm

To test the alarm:

1. Lower the driver window and open the driver door.

2. Press lock on the RKE transmitter.
3. Close the door and wait for the security light to go out.
4. Reach in through the window, unlock the door with the manual door lock, and open the door. This should set off the alarm.

If the alarm does not sound when it should but the headlamps flash, check to see if the horn works. The horn fuse may be blown. To replace the fuse, see *Fuses and Circuit Breakers on page 10-39*.

If the alarm does not sound or the headlamps do not flash, see your dealer for service.

### Immobilizer

See *Radio Frequency Statement on page 13-20* for information regarding Part 15 of the Federal Communications Commission (FCC) rules and Industry Canada Standards RSS-GEN/210/220/310.

### Immobilizer Operation

This vehicle has PASS-Key<sup>®</sup> III+ (Personalized Automotive Security System) theft-deterrent system. PASS-Key III+ is a passive theft-deterrent system.

The system is automatically armed when the key is removed from the ignition.

The system is automatically disarmed when the key is turned to ON/RUN, ACC/ACCESSORY, or START from the LOCK/OFF position.

You do not have to manually arm or disarm the system.

The security light will come on if there is a problem with arming or disarming the theft-deterrent system.

When the PASS-Key III+ system senses that someone is using the wrong key, it prevents the vehicle from starting. Anyone using a trial-and-error method to start the

## 2-12 Keys, Doors, and Windows

---

vehicle will be discouraged because of the high number of electrical key codes.

If the engine does not start and the security light on the instrument panel cluster comes on when trying to start the vehicle, there may be a problem with the theft-deterrent system. Turn the ignition off and try again.

If the engine still does not start, and the key appears to be undamaged, try another ignition key. At this time, you may also want to check the fuse. See *Fuses and Circuit Breakers on page 10-39*. If the engine still does not start with the other key, the vehicle needs service. If the vehicle does start, the first key may be faulty. See your dealer who can service the PASS-Key III+ to have a new key made.

It is possible for the PASS-Key III+ decoder to learn the transponder value of a new or replacement key.

Up to 10 keys may be programmed for the vehicle. The following procedure is for programming additional keys only. If all the currently programmed keys are lost or do not operate, you must see your dealer or a locksmith who can service PASS-Key III+ to have keys made and programmed to the system.

See your dealer or a locksmith who can service PASS-Key III+ to get a new key blank cut exactly as the ignition key that operates the system.

To program the new additional key:

1. Verify that the new key has a ⊕ stamped on it.
2. Insert the original, already programmed key in the ignition and start the engine. If the engine will not start, see your dealer for service.

3. After the engine has started, turn the key to LOCK/OFF, and remove the key.
4. Insert the new key to be programmed and turn it to the ON/RUN position within five seconds of turning the ignition to the LOCK/OFF position in Step 3.

The security light will turn off once the key has been programmed.

5. Repeat Steps 1 through 4 if additional keys are to be programmed.

If you lose or damage your PASS-Key III+ key, see your dealer or a locksmith who can service PASS-Key III+ to have a new key made.

Do not leave the key or device that disarms or deactivates the theft-deterrent system in the vehicle.

## Exterior Mirrors

### Convex Mirrors

 **WARNING**

A convex mirror can make things, like other vehicles, look farther away than they really are. If you cut too sharply into the right lane, you could hit a vehicle on the right. Check the inside mirror or glance over your shoulder before changing lanes.

The passenger side mirror is convex shaped. A convex mirror's surface is curved so more can be seen from the driver seat.

### Manual Mirrors

If the vehicle has manual mirrors, they can be adjusted by moving the mirror up and down or left to right to see a little of the side of the vehicle, and have a clear view behind the vehicle.

Using hood-mounted air deflectors and add-on convex mirror attachments could decrease mirror performance.

### Trailer-Tow Mirrors

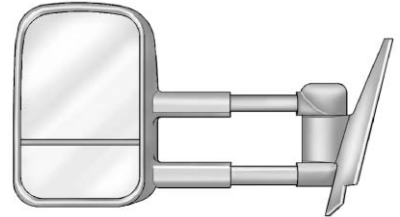

If the vehicle has towing mirrors, they can be adjusted for a clearer view of the objects behind you. Manually pull out the mirror head to extend it for better visibility when towing a trailer.

The lower portion of the mirror is convex. A convex mirror's surface is curved to see more from the driver seat. The convex mirror can be adjusted manually to the driver preferred position for better vision.

The mirror may have a turn signal arrow that flashes in the direction of the turn or lane change.

### Power Mirrors

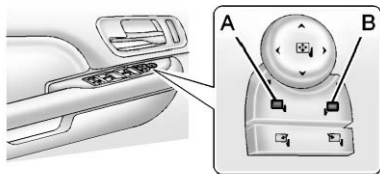

#### Crew Cab Premium Trim with Power Folding Mirrors Shown, Other Models Similar

1. Press (A) or (B) to select the driver or passenger side mirror.
2. Press the arrows on the control pad to move the mirror up, down, right, or left.

3. Adjust each outside mirror so that a little of the vehicle and the area behind it can be seen.
4. Press either (A) or (B) again to deselect the mirror.

The mirrors may also include a memory function that works with the memory seats. See *Memory Seats* on page 3-6 for more information.

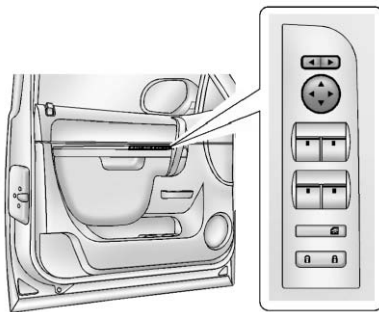

#### Crew Cab Up-Level Trim without Power Folding Mirrors

1. Move the selector switch located above the four-way control pad to the left or right to choose either the driver side or passenger side mirror.
2. Press one of the four arrows located on the control pad to move the mirror in the desired direction.
3. Adjust each outside mirror so that a little of the vehicle and the area behind it can be seen.

Keep the selector switch in the center position when not adjusting either outside mirror.

## Folding Mirrors

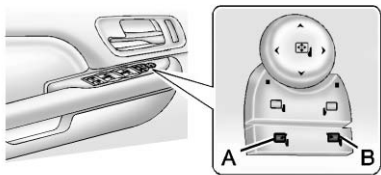

**Crew Cab Premium Trim with Power Folding Mirrors Shown, Other Models Similar**

### Power Folding

If equipped with power folding mirrors:

1. Press (A) to fold the mirrors out to the driving position.
2. Press (B) to fold the mirrors in to the folded position.

The mirrors may also include a memory function that works with the memory seats. See *Memory Seats on page 3-6* for more information.

### Resetting the Power Folding Mirrors

Reset the power folding mirrors if:

- The mirrors are accidentally obstructed while folding.
- They are accidentally manually folded/unfolded.
- The mirrors will not stay in the unfolded position.
- The mirrors vibrate at normal driving speeds.

Fold and unfold the mirrors one time using the mirror controls to reset them to their normal position.

A popping noise may be heard during the resetting of the power folding mirrors. This sound is normal after a manual folding operation.

### Manual Folding

If equipped with manual folding mirrors, push the mirror toward the vehicle. Push the mirror outward, to return to its original position.

Manually fold the mirrors inward to prevent damage when going through an automatic car wash.

### Automatic Dimming

If equipped with an automatic dimming mirror, the driver outside mirror automatically dimes for the glare of the headlamps from behind. This feature is controlled by the on and off setting on the inside rearview mirror.

See *Automatic Dimming Rearview Mirror on page 2-17*.

### Turn Signal Indicator

The vehicle may also have a turn signal indicator on the mirror. An arrow on the mirror flashes in the direction of the turn or lane change.

### Heated Mirrors

For vehicles with heated mirrors:

 **(Rear Window Defogger):**  
Press to heat the mirrors. If the vehicle has a towing mirror, only the upper glass of the mirror is heated. The lower convex part of the towing mirror is not heated.

Depending on the vehicle's features, see "Rear Window Defogger" under *Climate Control Systems (with Air Conditioning)* on page 8-1 or *Climate Control Systems (with Heater Only)* on page 8-4 or *Dual Automatic Climate Control System* on page 8-5 for more information.

### Park Tilt Mirrors

If the vehicle has the memory package, the passenger and/or driver mirror tilts to a preselected position when the vehicle is in R (Reverse). This feature lets the driver view the curb when parallel parking. The mirror(s) return to the original position when the vehicle is shifted out of R (Reverse), or the ignition is turned off or to OFF/LOCK.

Turn this feature on or off through the Driver Information Center (DIC). See *Vehicle Personalization (With DIC Buttons)* on page 5-46.

### Interior Mirrors

#### Manual Rearview Mirror

To adjust the inside rearview mirror, hold the rearview mirror in the center and move it to view the area behind the vehicle.

For vehicles with a manual rearview mirror, push the tab forward for daytime use and pull it rearward for nighttime use to avoid glare from the headlamps from behind.

Vehicles with OnStar<sup>®</sup> have three control buttons at the bottom of the mirror. See a dealer for more information about OnStar and how to subscribe to it. See *OnStar Overview* on page 14-1.



## Automatic Dimming Rearview Mirror

### Adjustment

Hold the rearview mirror in the center and move it to view the area behind the vehicle.

### Operation

For vehicles with an automatic dimming rearview mirror, the mirror will automatically reduce the glare of the headlamps from behind. The dimming feature comes on each time the vehicle is started.

**⏻ (On/Off):** Press to turn the dimming feature on or off.

The vehicle may also have a Rear Vision Camera (RVC). See *Rear Vision Camera (RVC)* on page 9-60.

If the vehicle has a RVC, the ⏻ button for turning the dimming feature on or off will not be available.

Vehicles with OnStar have three additional control buttons located at the bottom of the mirror. See a dealer for more information about OnStar and how to subscribe to it. See *OnStar Overview* on page 14-1.

### Cleaning the Mirror

Do not spray glass cleaner directly on the mirror. Use a soft towel dampened with water.

## Windows

### WARNING

Never leave a child, a helpless adult, or a pet alone in a vehicle, especially with the windows closed in warm or hot weather. They can be overcome by the extreme heat and suffer permanent injuries or even death from heat stroke.



## 2-18 Keys, Doors, and Windows

The vehicle aerodynamics are designed to improve fuel economy performance. This may result in a pulsing sound when either rear window is down and the front windows are up. To reduce the sound, open either a front window or the sunroof, if equipped.

### Manual Windows

Turn the hand crank on each door to manually raise or lower the manual windows.

### Power Windows

#### WARNING

Children could be seriously injured or killed if caught in the path of a closing window. Never leave keys in a vehicle with children. When there are children in the rear seat, use the window lockout button to prevent operation of the windows. See *Keys on page 2-1*.

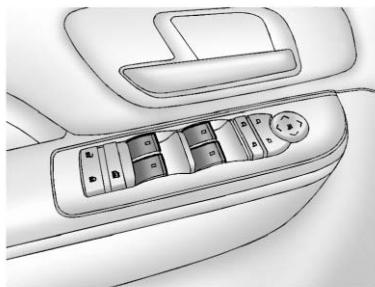

**Crew Cab Premium Trim Shown,  
Other Models Similar**

The driver door has a switch to control all windows. Each passenger door has a switch to control that window. The power windows only work when the ignition is in ON/RUN or ACC/ACCESSORY, or when Retained Accessory Power (RAP) is active. See *Retained Accessory Power (RAP) on page 9-27*.

Push the switch down to lower the window, and pull up the front of the switch to raise the window.

### Express-down Windows

The express-down feature allow the driver and front passenger windows to be lowered without holding the switch. Push the switch down to the second detent, then release, to activate the express-down mode. The express-down mode can be canceled at any time by pulling up on the front of the switch. To open the window partway, push the switch down to the first detent until the window is at the desired position.

## Window Lockout

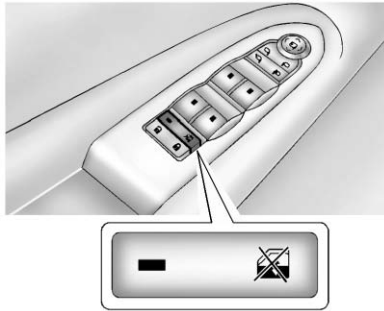

**Crew Cab Premium Trim Shown, Other Models Similar**

 **(Window Lockout):** The driver door power window switch has a lockout feature. This feature prevents the rear windows from operating, except from the driver position. Press the switch to engage or disengage the lockout feature. An indicator light on the switch will come on when the lockout feature is engaged, and will go off when disengaged.

## Rear Windows

### Power Sliding Rear Window



If equipped, the power sliding rear window works when the ignition has been turned to ACC/ACCESSORY or ON/RUN, or when Retained Accessory Power (RAP) is active. See *Retained Accessory Power (RAP)* on page 9-27.

- Press the switch to open the window.
- Pull the switch to close the window.

The power sliding rear window cannot be operated manually.

## Sun Visors

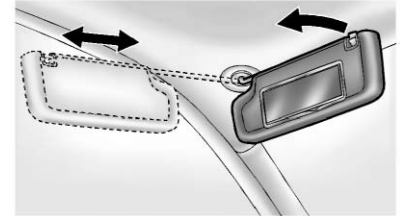

Pull the sun visor down to block glare. Detach the sun visor from the center mount to pivot to the side window, or to extend along the rod, if available.

### Roof

#### Sunroof (Extended Cab)

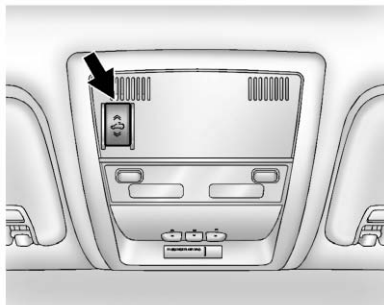

On vehicles with a sunroof, the sunroof only operates when the ignition is in the ACC/ACCESSORY or ON/RUN or the Retained Accessory Power (RAP) is active. See *Retained Accessory Power (RAP)* on page 9-27.

**Vent:** From the closed position, press and hold the rear of the switch to vent the sunroof. To close the sunroof, press and hold the front of the switch.

**Open:** From the vent position, the sunroof can be fully opened either manually or by using the express-open feature. To open manually, press the rear of the switch to the first detent and hold until the sunroof has reached the desired position. To open using express-open, press the rear of the switch to the second detent and release. The sunroof will move to the full open position. To stop the sunroof partway, press the switch a second time.

**Close:** From the vent, or open position, press and hold the front of the switch to close the sunroof.

The sunroof also has a roller sunshade that can be used to block the rays of the sun. The roller sunshade can be manually operated with the sunroof in an open or

closed position. To open the sunshade, press and unlatch it, and roll it back. To close, pull it forward and latch it into the closed position.

When the sunroof is opened, an air deflector will automatically raise. The air deflector will retract when the sunroof is closed.

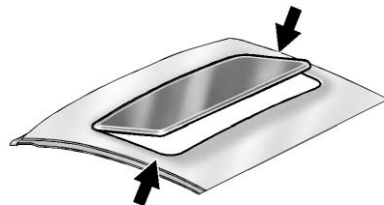

Dirt and debris may collect on the sunroof seal or in the track. This could cause an issue with sunroof operation or noise. It could also plug the water drainage system. Periodically open the sunroof and remove any obstacles or loose debris. Wipe the sunroof seal and

roof sealing area using a clean cloth, mild soap, and water. Do not remove grease from the sunroof.

## Sunroof (Crew Cab)

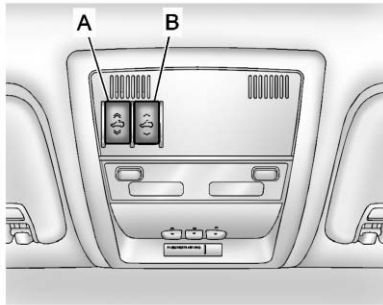

A. Open or Close

B. Vent

On vehicles with a sunroof, the sunroof only operates when the ignition is in the ACC/ACCESSORY or ON/RUN or the Retained Accessory Power (RAP) is active. See *Retained Accessory Power (RAP)* on page 9-27.

**Vent:** From the closed position, press the rear of the passenger side switch (B) to vent the sunroof.

**Manual-Open/Manual-Close:** To open the sunroof, press and hold the rear of the driver side switch (A) until the sunroof reaches the desired position. Press and hold the front of the driver side switch to close it.

**Express-Open/Express-Close:** To express-open the sunroof, fully press and release the rear of the driver side switch (A) until the sunroof reaches the desired position. To express-close the sunroof, fully press and release the front of the driver side switch. Press the switch again to stop it.

When the sunroof is opened, an air deflector will automatically raise. The air deflector will retract when the sunroof is closed.

The sunroof also has a sunshade which can be pulled forward to block sun rays. The sunshade must be opened and closed manually.

If an object is in the path of the sunroof while it is closing, the anti-pinch feature will detect the object and stop the sunroof.

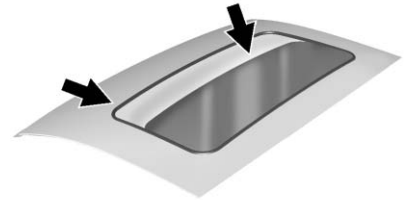

Dirt and debris may collect on the sunroof seal or in the track. This could cause an issue with sunroof operation or noise. It could also plug the water drainage system. Periodically open the sunroof and remove any obstacles or loose debris. Wipe the sunroof seal and roof sealing area using a clean cloth, mild soap, and water. Do not remove grease from the sunroof.



## Seats and Restraints

### Head Restraints

Head Restraints ..... 3-2

### Front Seats

Seat Adjustment ..... 3-3  
 Center Seat ..... 3-3  
 Power Seat Adjustment ..... 3-4  
 Lumbar Adjustment ..... 3-4  
 Reclining Seatbacks ..... 3-5  
 Memory Seats ..... 3-6  
 Heated and Ventilated Front  
 Seats ..... 3-8

### Rear Seats

Rear Seats (Extended Cab Full  
 Bench) ..... 3-9  
 Rear Seats (All Split Bench  
 and Hybrid Full Bench) ..... 3-10

### Safety Belts

Safety Belts ..... 3-11  
 How to Wear Safety Belts  
 Properly ..... 3-12

Lap-Shoulder Belt ..... 3-13  
 Safety Belt Use During  
 Pregnancy ..... 3-18  
 Lap Belt (Crew and  
 Extended Cab) ..... 3-18  
 Safety Belt Extender ..... 3-19  
 Safety System Check ..... 3-19  
 Safety Belt Care ..... 3-19  
 Replacing Safety Belt System  
 Parts after a Crash ..... 3-20

### Airbag System

Airbag System ..... 3-20  
 Where Are the Airbags? .... 3-22  
 When Should an Airbag  
 Inflate? ..... 3-24  
 What Makes an Airbag  
 Inflate? ..... 3-26  
 How Does an Airbag  
 Restrain? ..... 3-26  
 What Will You See after an  
 Airbag Inflates? ..... 3-26  
 Airbag On-Off Switch ..... 3-28  
 Passenger Sensing  
 System ..... 3-31  
 Servicing the Airbag-Equipped  
 Vehicle ..... 3-35

Adding Equipment to the  
 Airbag-Equipped Vehicle ... 3-35  
 Airbag System Check ..... 3-37  
 Replacing Airbag System  
 Parts after a Crash ..... 3-37

### Child Restraints

Older Children ..... 3-38  
 Infants and Young  
 Children ..... 3-40  
 Child Restraint Systems .... 3-42  
 Where to Put the Restraint ... 3-44  
 Lower Anchors and Tethers  
 for Children (LATCH  
 System) ..... 3-45  
 Replacing LATCH System  
 Parts After a Crash ..... 3-54  
 Securing Child Restraints  
 (Rear Seat Position) ..... 3-54  
 Securing Child Restraints  
 (Center Front Seat  
 Position) ..... 3-56  
 Securing Child Restraints  
 (Right Front Seat  
 Position) ..... 3-57

## 3-2 Seats and Restraints

### Head Restraints

#### Front Seats

The front seats have adjustable head restraints in the outboard seating positions.

#### **WARNING**

With head restraints that are not installed and adjusted properly, there is a greater chance that occupants will suffer a neck/spinal injury in a crash. Do not drive until the head restraints for all occupants are installed and adjusted properly.



Adjust the head restraint so that the top of the restraint is at the same height as the top of the occupant's head. This position reduces the chance of a neck injury in a crash.

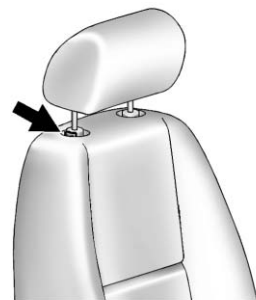

The height of the head restraint can be adjusted. Pull the head restraint up to raise it. Try to move the head restraint to make sure that it is locked in place.

To lower the head restraint, press the button, located on the top of the seatback, and push the restraint down. Try to move the head restraint after the button is released to make sure that it is locked in place.

The front seat outboard head restraints are not designed to be removed.



## Rear Seats

The rear seat has adjustable headrests in the outboard seating positions.

The height of the headrest can be adjusted. Pull the headrest up to raise it. To lower the headrest, push down on the headrest.

Rear outboard headrests are not designed to be removed.

## Front Seats

### Seat Adjustment

#### **WARNING**

You can lose control of the vehicle if you try to adjust a driver seat while the vehicle is moving. Adjust the driver seat only when the vehicle is not moving.

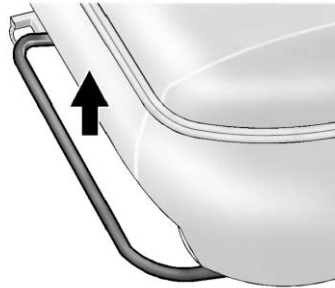

To adjust the seat:

1. Lift the bar under the front edge of the seat cushion to unlock the seat.
2. Slide the seat to the desired position and release the bar.
3. Try to move the seat back and forth to be sure the seat is locked in place.

### Center Seat

If equipped, the center front seatback doubles as an armrest and cupholder/storage area for the driver and passenger when the center front seat is not used. Do not use it as a seating position when the seatback is folded down.

## 3-4 Seats and Restraints

### Power Seat Adjustment



To adjust a power seat, if equipped:

- Move the seat forward or rearward by sliding the control forward or rearward.
- If available, raise or lower the front or rear part of the seat cushion by moving the front or rear of the control up or down.
- If available, raise or lower the entire seat by moving the entire control up or down.

To adjust the seatback, see “Power Reclining Seatbacks” under *Reclining Seatbacks* on page 3-5.

### Lumbar Adjustment

#### Manual Lumbar

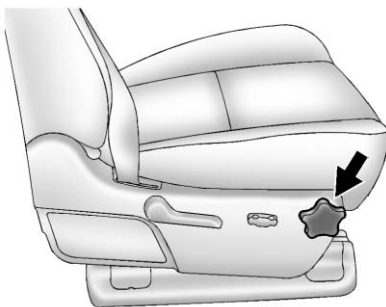

If equipped, increase or decrease manual lumbar support by turning the knob forward or rearward.

### Power Lumbar



To adjust the power lumbar support, if equipped:

- On vehicles with two-way lumbar, press and hold the top or bottom of the control to increase or decrease lumbar support.
- On vehicles with four-way lumbar, press and hold the front or rear of the control to increase or decrease lumbar support. To

raise or lower the height of the support, press and hold the top or bottom of the control.

## Reclining Seatbacks

### WARNING

Sitting in a reclined position when the vehicle is in motion can be dangerous. Even when buckled up, the safety belts cannot do their job.

The shoulder belt will not be against your body. Instead, it will be in front of you. In a crash, you could go into it, receiving neck or other injuries.

The lap belt could go up over your abdomen. The belt forces would be there, not at your pelvic bones. This could cause serious internal injuries.

(Continued)

### WARNING (Continued)

For proper protection when the vehicle is in motion, have the seatback upright. Then sit well back in the seat and wear the safety belt properly.



Do not have a seatback reclined if the vehicle is moving.

## Manual Reclining Seatbacks

### WARNING

If either seatback is not locked, it could move forward in a sudden stop or crash. That could cause injury to the person sitting there. Always push and pull on the seatbacks to be sure they are locked.

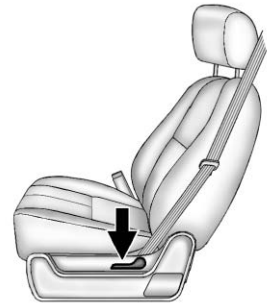

## 3-6 Seats and Restraints

To adjust a manual seatback:

1. Lift the lever.  
The seatback will automatically fold forward.
2. To recline, move the seatback rearward to the desired position, then release the lever to lock the seatback in place.
3. Push and pull on the seatback to make sure it is locked.

To return the seatback to the upright position:

1. Lift the lever fully without applying pressure to the seatback, and the seatback will return to the upright position.
2. Push and pull on the seatback to make sure it is locked.

### Power Reclining Seatbacks



To recline a power seatback, if equipped:

- Tilt the top of the control rearward to recline.
- Tilt the top of the control forward to raise.

### Memory Seats

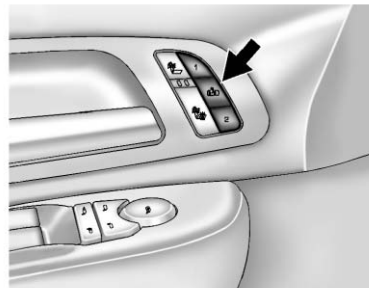

If available, the controls on the driver door are used to program and recall memory settings for the driver seat, outside mirrors, and the adjustable throttle and brake pedals, if equipped.

## Storing Memory Positions

To save into memory:

1. Adjust the driver seat, seatback recliner, both outside mirrors, and the throttle and brake pedals, if equipped.

See *Power Mirrors on page 2-14* and *Adjustable Throttle and Brake Pedal on page 9-23*.

Not all mirrors and adjustable throttle and brake pedals will have the ability to save and recall their positions.

2. Press and hold “1” until two beeps sound.
3. Repeat for a second driver position using “2.”

To recall, press and release “1” or “2.” The vehicle must be in P (Park). A single beep will sound. The seat, outside mirrors, and adjustable throttle and brake pedals will move to the position previously stored for the identified driver.

## Memory Remote Recall

The memory feature can recall the driver seat, outside mirrors, and pedals, if equipped, to stored positions when entering the vehicle.

To activate, unlock the driver door with the Remote Keyless Entry (RKE) transmitter. The driver seat, outside mirrors, and adjustable pedals, if equipped, will move to the memory position associated with the transmitter used to unlock the vehicle.

This feature can be turned on or off using the vehicle personalization menu. See *Vehicle Personalization (With DIC Buttons) on page 5-46*.

To stop recall movement, press one of the power seat controls, memory buttons, or power mirror buttons, or the adjustable pedal switch.

If something has blocked the driver seat and/or the adjustable pedals while recalling a memory position, the recall may stop. Remove the obstruction; then press and hold the appropriate manual control for the memory item that is not recalling for two seconds. Try recalling the memory position again by pressing the appropriate memory button. If the memory position is still not recalling, see your dealer for service.

## Easy Exit Driver Seat

This feature can move the seat rearward to allow extra room to exit the vehicle.

 **(Easy Exit Driver Seat):** Press to recall the easy exit seat position. The vehicle must be in P (Park).

If the easy exit seat feature is programmed on in the vehicle personalization menu, automatic seat movement occurs when the ignition key is removed.

## 3-8 Seats and Restraints

A single beep sounds. The driver seat moves back approximately 8 cm (3 in). To move the seat back farther, press  again until the seat is all the way back.

If something has blocked the driver seat while recalling the exit position, the recall may stop. Remove the obstruction; then press and hold the power seat control rearward for two seconds. Try recalling the exit position again. If the exit position is still not recalling, see your dealer for service.

See *Vehicle Personalization (With DIC Buttons)* on page 5-46.

### Heated and Ventilated Front Seats

#### WARNING

If you cannot feel temperature change or pain to the skin, the seat heater may cause burns. To reduce the risk of burns, people with such a condition should use care when using the seat heater, especially for long periods of time. Do not place anything on the seat that insulates against heat, such as a blanket, cushion, cover, or similar item. This may cause the seat heater to overheat. An overheated seat heater may cause a burn or may damage the seat.

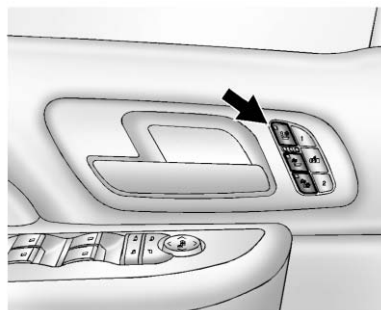

#### Heated and Cooled Seat Buttons Shown, Heated Seat Buttons Similar

If available, the buttons are on the front doors. To operate, the ignition must be in ON/RUN.

 **(Cooled Seat):** If available, press to cool the seat.

 **(Heated Seatback):** Press to heat the seatback only.

 **(Heated Seat and Seatback):** Press to heat the seat and seatback.

Press the button once for the highest setting. With each press of the button, the seat will change to the next lower setting, and then to the off setting. The lights indicate three for the highest setting and one for the lowest.

The passenger seat may take longer to heat up.

On vehicles with heated seats, the heated seats are canceled 10 seconds after the ignition is turned off.

On vehicles with heated and cooled seats, the heated and cooled seats are canceled when the ignition is turned off.

To use this feature after restarting the vehicle, press the desired button again.

### Remote Start Heated Seats

When it is cold outside, the heated seats may turn on automatically during a remote vehicle start. The heated seats will be canceled when the ignition is turned on. Press the desired button to use the heated seats after the vehicle is started.

The lights on the heated seat buttons do not turn on during a remote start.

The temperature performance of an unoccupied seat may be reduced. This is normal.

See *Remote Vehicle Start* on page 2-4.

## Rear Seats

### Rear Seats (Extended Cab Full Bench)

#### Folding the Rear Seat

**Notice:** Folding a rear seat with the safety belts still fastened may cause damage to the seat or the safety belts. Always unbuckle the safety belts and return them to their normal stowed position before folding a rear seat.

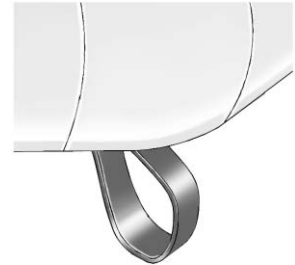

## 3-10 Seats and Restraints

To fold the seat:

1. Pull up on the front of the seat cushion while pulling down on the release strap under the seat cushion.
2. Pull the seat cushion up until it latches with the seatback.
3. Pull forward on the seat cushion to make sure it is locked in place.

To unfold the seat:

1. Push the seat cushion rearward while pulling the release strap under the seat cushion. Pull the seat cushion down until it latches.
2. Pull up on the seat cushion to make sure it is locked in place.

Make sure the safety belts are not twisted or caught in the seat cushion.

### WARNING

A safety belt that is improperly routed, not properly attached, or twisted will not provide the protection needed in a crash. The person wearing the belt could be seriously injured. After raising the rear seatback, always check to be sure that the safety belts are properly routed and attached, and are not twisted.

## Rear Seats (All Split Bench and Hybrid Full Bench)

### Folding Rear Seat

Either side of the rear seat can be folded for added cargo space.

**Notice:** Folding a rear seat with the safety belts still fastened may cause damage to the seat or the safety belts. Always unbuckle the

**safety belts and return them to their normal stowed position before folding a rear seat.**

Make sure that nothing is on the seat.

To fold the seat, slowly pull the seat cushion up.

To return the seat to the normal seating position, slowly pull the seat cushion down.

Make sure the safety belts are not twisted or caught in the seat cushion.

### WARNING

A safety belt that is improperly routed, not properly attached, or twisted will not provide the protection needed in a crash. The person wearing the belt could be seriously injured. After raising the rear seatback, always check to be sure that the safety belts are properly routed and attached, and are not twisted.



## Safety Belts

This section of the manual describes how to use safety belts properly. It also describes some things not to do with safety belts.

### WARNING

Do not let anyone ride where a safety belt cannot be worn properly. In a crash, if you or your passenger(s) are not wearing safety belts, injuries can be much worse than if you are wearing safety belts. You can be seriously injured or killed by hitting things inside the vehicle harder or by being ejected from the vehicle. In addition, anyone who is not buckled up can strike other passengers in the vehicle.

(Continued)

### WARNING (Continued)

It is extremely dangerous to ride in a cargo area, inside or outside of a vehicle. In a collision, passengers riding in these areas are more likely to be seriously injured or killed. Do not allow passengers to ride in any area of the vehicle that is not equipped with seats and safety belts.

Always wear a safety belt, and check that all passenger(s) are restrained properly too.

This vehicle has indicators as a reminder to buckle the safety belts. See *Safety Belt Reminders* on page 5-16.

## Why Safety Belts Work

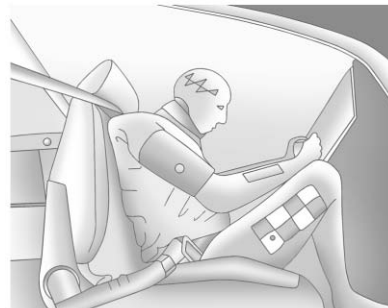

When riding in a vehicle, you travel as fast as the vehicle does. If the vehicle stops suddenly, you keep going until something stops you. It could be the windshield, the instrument panel, or the safety belts!

When you wear a safety belt, you and the vehicle slow down together. There is more time to stop because you stop over a longer distance and, when worn properly, your strongest bones take the forces from the

## 3-12 Seats and Restraints

safety belts. That is why wearing safety belts makes such good sense.

### Questions and Answers About Safety Belts

**Q: Will I be trapped in the vehicle after a crash if I am wearing a safety belt?**

**A:** You *could* be — whether you are wearing a safety belt or not. Your chance of being conscious during and after a crash, so you *can* unbuckle and get out, is *much* greater if you are belted.

**Q: If my vehicle has airbags, why should I have to wear safety belts?**

**A:** Airbags are supplemental systems only; so they work *with* safety belts — not instead of them. Whether or not an airbag is provided, all occupants still have to buckle up to get the most protection.

Also, in nearly all states and in all Canadian provinces, the law requires wearing safety belts.

### How to Wear Safety Belts Properly

This section is only for people of adult size.

There are special things to know about safety belts and children. And there are different rules for smaller children and infants. If a child will be riding in the vehicle, see *Older Children on page 3-38* or *Infants and Young Children on page 3-40*. Follow those rules for everyone's protection.

It is very important for all occupants to buckle up. Statistics show that unbelted people are hurt more often in crashes than those who are wearing safety belts.

There are important things to know about wearing a safety belt properly.

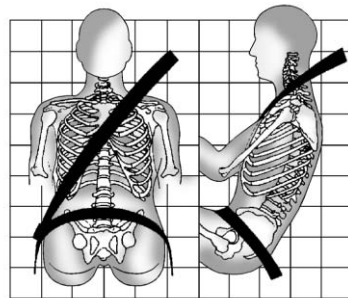

- Sit up straight and always keep your feet on the floor in front of you.
- Always use the correct buckle for your seating position.
- Wear the lap part of the belt low and snug on the hips, just touching the thighs. In a crash, this applies force to the strong pelvic bones and you would be less likely to slide under the lap belt. If you slid under it, the belt would apply force on your abdomen. This could cause serious or even fatal injuries.

- Wear the shoulder belt over the shoulder and across the chest. These parts of the body are best able to take belt restraining forces. The shoulder belt locks if there is a sudden stop or crash.

 **WARNING**

You can be seriously injured, or even killed, by not wearing your safety belt properly.

- Never allow the lap or shoulder belt to become loose or twisted.
- Never wear the shoulder belt under both arms or behind your back.
- Never route the lap or shoulder belt over an armrest.

### Lap-Shoulder Belt

If the vehicle is a regular cab, then all seating positions in the vehicle have a lap-shoulder belt. If the vehicle is a crew or extended cab, then all seating positions in the vehicle have a lap-shoulder belt except for the center front passenger position (if equipped), which has a lap belt. See *Lap Belt (Crew and Extended Cab)* on page 3-18 for more information.

The following instructions explain how to wear a lap-shoulder belt properly.

1. Adjust the seat, if the seat is adjustable, so you can sit up straight. To see how, see “Seats” in the Index.

2. Pick up the latch plate and pull the belt across you. Do not let it get twisted.

The lap-shoulder belt may lock if you pull the belt across you very quickly. If this happens, let the belt go back slightly to unlock it. Then pull the belt across you more slowly.

If the shoulder portion of a passenger belt is pulled out all the way, the child restraint locking feature may be engaged. If this happens, let the belt go back all the way and start again.

Engaging the child restraint locking feature may affect the passenger sensing system, if equipped. See *Passenger Sensing System* on page 3-31 for more information.

## 3-14 Seats and Restraints

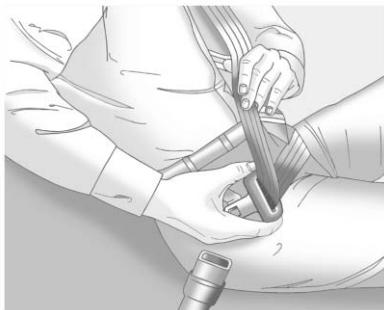

If the belt stops before it reaches the buckle, when using the lap-shoulder belt in a rear center seating position of a crew-cab, tilt the latch plate and keep pulling the safety belt until it can be buckled.



3. Push the latch plate into the buckle until it clicks.

Pull up on the latch plate to make sure it is secure. If the belt is not long enough, see *Safety Belt Extender* on page 3-19.

If the latch plate will not go fully into the buckle, check if the correct buckle is being used.

Position the release button on the buckle so that the safety belt could be quickly unbuckled if necessary.

4. If equipped with a shoulder belt height adjuster, move it to the height that is right for you. See "Shoulder Belt Height Adjuster" later in this section.

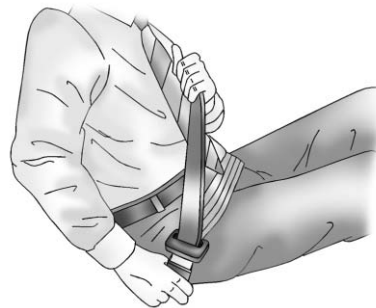

5. To make the lap part tight, pull up on the shoulder belt.

It may be necessary to pull stitching on the safety belt through the latch plate to fully tighten the lap belt on smaller occupants.

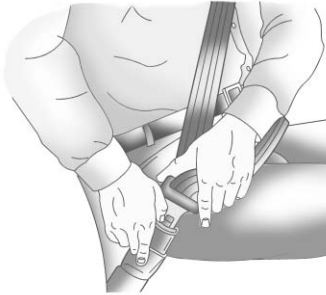

To unlatch the belt, push the button on the buckle. The belt should return to its stowed position.

Before a door is closed, be sure the safety belt is out of the way. If a door is slammed against a safety belt, damage can occur to both the safety belt and the vehicle.

### Shoulder Belt Height Adjuster

The vehicle has a shoulder belt height adjuster for the driver and right front passenger.

Adjust the height so the shoulder portion of the belt is on the shoulder and not falling off of it. The belt should be close to, but not contacting, the neck. Improper shoulder belt height adjustment could reduce the effectiveness of the safety belt in a crash. See *How to Wear Safety Belts Properly* on page 3-12.

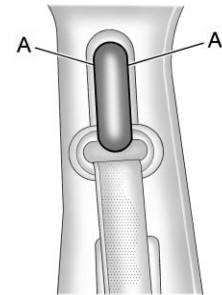

### Regular and Crew Cab

To move the adjuster down for the regular and crew cabs, squeeze the buttons (A) on the sides of the height adjuster and move the height adjuster to the desired position.

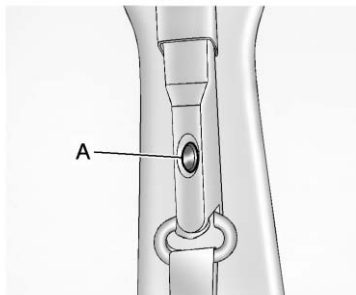

### Extended Cab

On the extended cab, push down on the release button (A) and move the height adjuster to the desired position.

You can move the adjuster up just by pushing up on the shoulder belt guide.

After you move the adjuster to where you want it, try to move it down, without squeezing the buttons for the regular and crew cabs, or without pushing the release button for extended cabs, to make sure it has locked into position.

### Safety Belt Pretensioners

This vehicle has safety belt pretensioners for front outboard occupants. Although the safety belt pretensioners cannot be seen, they are part of the safety belt assembly. They can help tighten the safety belts during the early stages of a moderate to severe frontal, near frontal, or rear crash if the threshold conditions for pretensioner activation are met. And, if your vehicle has side impact airbags, safety belt pretensioners can help tighten the safety belts in a side crash or a rollover event.

Pretensioners work only once. If the pretensioners activate in a crash, they will need to be replaced, and probably other new parts for the vehicle's safety belt system. See *Replacing Safety Belt System Parts after a Crash* on page 3-20.

### Rear Safety Belt Comfort Guides

This vehicle may have rear shoulder belt comfort guides. If not, they are available through your dealer. The guides may provide added safety belt comfort for older children who have outgrown booster seats and for some adults. When installed and properly adjusted, the comfort guide positions the belt away from the neck and head.

Here is how to install a comfort guide to the shoulder belt:

1. Remove the guide from its storage clip on the interior body.



2. Place the guide over the belt and insert the two edges of the belt into the slots of the guide.

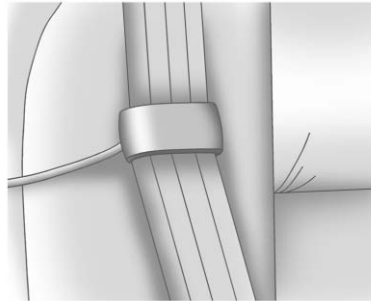

3. Be sure that the belt is not twisted and it lies flat. The elastic cord must be under the belt and the guide on top.

**⚠ WARNING**

A safety belt that is not properly worn may not provide the protection needed in a crash. The person wearing the belt could be seriously injured. The shoulder belt should go over the shoulder  
(Continued)

**WARNING (Continued)**

and across the chest. These parts of the body are best able to take belt restraining forces.

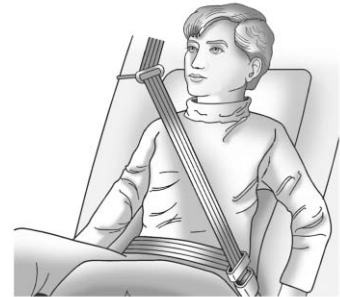

4. Buckle, position, and release the safety belt as described previously in this section. Make sure the shoulder portion of the belt is on the shoulder and not falling off of it. The belt should be close to, but not contacting, the neck.

## 3-18 Seats and Restraints

To remove and store the comfort guide, squeeze the belt edges together so that the safety belt can be removed from the guide. Slide the guide onto the storage clip.

### Safety Belt Use During Pregnancy

Safety belts work for everyone, including pregnant women. Like all occupants, they are more likely to be seriously injured if they do not wear safety belts.



A pregnant woman should wear a lap-shoulder belt, and the lap portion should be worn as low as possible, below the rounding, throughout the pregnancy.

The best way to protect the fetus is to protect the mother. When a safety belt is worn properly, it is more likely that the fetus will not be hurt in a crash. For pregnant women, as for anyone, the key to making safety belts effective is wearing them properly.

### Lap Belt (Crew and Extended Cab)

This section is only for the lap belt. To learn how to wear a lap-shoulder belt, see *Lap-Shoulder Belt* on page 3-13.

Your vehicle may have a center seating position. When you sit in the center front seating position, you have a lap safety belt, which has no retractor.

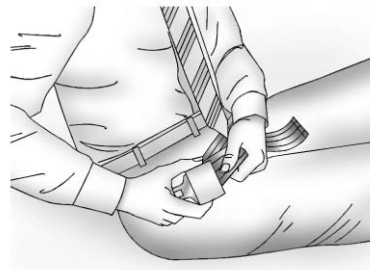

To make the belt longer, tilt the latch plate and pull it along the belt.

Buckle, position, and release it the same way as the lap part of a lap-shoulder belt.



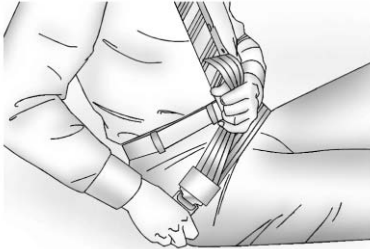

To make the belt shorter, pull its free end as shown until the belt is snug.

If the belt is not long enough, see *Safety Belt Extender* on page 3-19.

Make sure the release button on the buckle is positioned so you would be able to unbuckle the safety belt quickly if necessary.

### Safety Belt Extender

If the vehicle's safety belt will fasten around you, you should use it.

But if a safety belt is not long enough, your dealer will order you an extender. When you go in to order it, take the heaviest coat you will wear, so the extender will be long enough for you. To help avoid personal injury, do not let someone else use it, and use it only for the seat it is made to fit. The extender has been designed for adults. Never use it for securing child seats. To wear it, attach it to the regular safety belt. For more information, see the instruction sheet that comes with the extender.

### Safety System Check

Now and then, check that the safety belt reminder light, safety belts, buckles, latch plates, retractors, and anchorages are all working properly.

Look for any other loose or damaged safety belt system parts that might keep a safety belt system from doing its job. See your dealer to have it repaired. Torn or frayed safety belts may not protect you in a crash. They can rip apart under impact forces. If a belt is torn or frayed, get a new one right away.

Make sure the safety belt reminder light is working. See *Safety Belt Reminders* on page 5-16.

Keep safety belts clean and dry. See *Safety Belt Care* on page 3-19.

### Safety Belt Care

Keep belts clean and dry.

#### WARNING

Do not bleach or dye safety belts. It may severely weaken them. In a crash, they might not be able to provide adequate protection. Clean safety belts only with mild soap and lukewarm water.

### Replacing Safety Belt System Parts after a Crash

 **WARNING**

A crash can damage the safety belt system in the vehicle. A damaged safety belt system may not properly protect the person using it, resulting in serious injury or even death in a crash. To help make sure the safety belt systems are working properly after a crash, have them inspected and any necessary replacements made as soon as possible.

After a minor crash, replacement of safety belts may not be necessary. But the safety belt assemblies that were used during any crash may have been stressed or damaged. See your dealer to have the safety belt assemblies inspected or replaced.

New parts and repairs may be necessary even if the safety belt system was not being used at the time of the crash.

Have the safety belt pretensioners checked if the vehicle has been in a crash, or if the airbag readiness light stays on after you start the vehicle or while you are driving. See *Airbag Readiness Light* on page 5-17.

### Airbag System

The vehicle has the following airbags:

- A frontal airbag for the driver.
- A frontal airbag for the right front passenger.

The vehicle may have the following airbags:

- A seat-mounted side impact airbag for the driver.
- A seat-mounted side impact airbag for the right front passenger.
- A roof-rail airbag for the driver and the passenger seated directly behind the driver.
- A roof-rail airbag for the right front passenger and the person seated directly behind the right front passenger.

All of the airbags in the vehicle will have the word AIRBAG embossed in the trim or on an attached label near the deployment opening.

For frontal airbags, the word AIRBAG will appear on the middle part of the steering wheel for the driver and on the instrument panel for the right front passenger.

With seat-mounted side impact airbags, the word AIRBAG will appear on the side of the seatback closest to the door.

With roof-rail airbags, the word AIRBAG will appear along the headliner or trim.

Airbags are designed to supplement the protection provided by safety belts. Even though today's airbags are also designed to help reduce the risk of injury from the force of an inflating bag, all airbags must inflate very quickly to do their job.

Here are the most important things to know about the airbag system:

 **WARNING**

You can be severely injured or killed in a crash if you are not wearing your safety belt — even if you have airbags. Airbags are designed to work with safety belts, but do not replace them. Also, airbags are not designed to deploy in every crash. In some crashes safety belts are your only restraint. See *When Should an Airbag Inflate?* on page 3-24.

Wearing your safety belt during a crash helps reduce your chance of hitting things inside the vehicle or being ejected from it. Airbags are “supplemental restraints” to the safety belts. Everyone in your vehicle should wear a safety belt properly — whether or not there is an airbag for that person.

 **WARNING**

Because airbags inflate with great force and faster than the blink of an eye, anyone who is up against, or very close to any airbag when it inflates can be seriously injured or killed. Do not sit unnecessarily close to any airbag, as you would be if sitting on the edge of the seat or leaning forward. Safety belts help keep you in position before and during a crash. Always wear a safety belt, even with airbags. The driver should sit as far back as possible while still maintaining control of the vehicle.

Occupants should not lean on or sleep against the door or side windows in seating positions with seat-mounted side impact airbags and/or roof-rail airbags.

## 3-22 Seats and Restraints

### WARNING

Children who are up against, or very close to, any airbag when it inflates can be seriously injured or killed. Airbags plus lap-shoulder belts offer protection for adults and older children, but not for young children and infants. Neither the vehicle safety belt system nor its airbag system is designed for them. Young children and infants need the protection that a child restraint system can provide. Always secure children properly in the vehicle. To read how, see *Older Children on page 3-38* or *Infants and Young Children on page 3-40*.



There is an airbag readiness light on the instrument panel cluster, which shows the airbag symbol.

The system checks the airbag electrical system for malfunctions. The light tells you if there is an electrical problem. See *Airbag Readiness Light on page 5-17* for more information.

## Where Are the Airbags?



The driver airbag is in the middle of the steering wheel.



The right front passenger airbag is in the instrument panel on the passenger side.



**Driver Side Shown, Passenger Side Similar**

If the vehicle has seat-mounted side impact airbags for the driver and right front passenger, they are in the side of the seatbacks closest to the door.

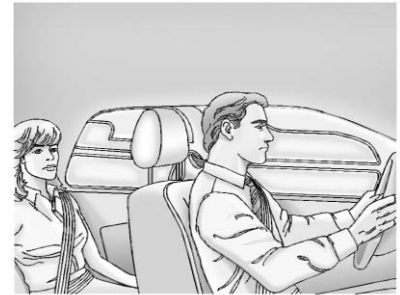

**Driver Side Shown, Passenger Side Similar**

If the vehicle has roof-rail airbags for the driver, right front passenger, and second row outboard passengers, they are in the ceiling above the side windows.

**⚠ WARNING**

If something is between an occupant and an airbag, the airbag might not inflate properly or it might force the object into

(Continued)

### **WARNING (Continued)**

that person causing severe injury or even death. The path of an inflating airbag must be kept clear. Do not put anything between an occupant and an airbag, and do not attach or put anything on the steering wheel hub or on or near any other airbag covering.

Do not use seat accessories that block the inflation path of a seat-mounted side impact airbag.

Never secure anything to the roof of a vehicle with roof-rail airbags by routing a rope or tie-down through any door or window opening. If you do, the path of an inflating roof-rail airbag will be blocked.

### **When Should an Airbag Inflate?**

Frontal airbags are designed to inflate in moderate to severe frontal or near-frontal crashes to help reduce the potential for severe injuries mainly to the driver's or right front passenger's head and chest. However, they are only designed to inflate if the impact exceeds a predetermined deployment threshold. Deployment thresholds are used to predict how severe a crash is likely to be in time for the airbags to inflate and help restrain the occupants.

Whether the frontal airbags will or should deploy is not based on how fast your vehicle is traveling. It depends largely on what you hit, the direction of the impact, and how quickly your vehicle slows down.

Frontal airbags may inflate at different crash speeds. For example:

- If the vehicle hits a stationary object, the airbags could inflate at a different crash speed than if the vehicle hits a moving object.
- If the vehicle hits an object that deforms, the airbags could inflate at a different crash speed than if the vehicle hits an object that does not deform.
- If the vehicle hits a narrow object (like a pole), the airbags could inflate at a different crash speed than if the vehicle hits a wide object (like a wall).
- If the vehicle goes into an object at an angle, the airbags could inflate at a different crash speed than if the vehicle goes straight into the object.

Thresholds can also vary with specific vehicle design.

Frontal airbags are not intended to inflate during vehicle rollovers, rear impacts, or in many side impacts.

If the GVWR (Gross Vehicle Weight Rating) of your vehicle is 3 855 kg (8,500 lb) or above, the vehicle has single stage airbags. If the GVWR is below 3 855 kg (8,500 lb) then the vehicle has dual stage airbags.

Vehicles with a full bench seat are equipped with single state airbags. You can find the GVWR on the certification label on the rear edge of the driver door. See *Vehicle Load Limits* on page 9-15 for more information.

The vehicle may have dual-stage frontal airbags. Dual-stage airbags adjust the restraint according to crash severity. The vehicle has electronic frontal sensors, which help the sensing system distinguish between a moderate frontal impact and a more severe frontal impact. For moderate frontal impacts, dual-stage airbags inflate at a level

less than full deployment. For more severe frontal impacts, full deployment occurs.

Vehicles with dual stage airbags also have seat position sensors which enable the sensing system to monitor the position of the driver seat (all models), and on crew cab and extended cab models the right front passenger seat on light duty models only. The seat position sensor provides information that is used to determine if the airbags should deploy at a reduced level or at full deployment.

The vehicle may or may not have seat-mounted side impact and roof-rail airbags. See *Airbag System* on page 3-20. Seat-mounted side impact and roof-rail airbags are intended to inflate in moderate to severe side crashes. In addition, these roof-rail airbags are intended to inflate during a rollover or in a severe frontal impact. Seat-mounted side impact and roof-rail airbags will inflate if the crash severity is above

the system's designed threshold level. The threshold level can vary with specific vehicle design.

Roof-rail airbags are not intended to inflate in rear impacts.

A seat-mounted side impact airbag is intended to deploy on the side of the vehicle that is struck. Both roof-rail airbags will deploy when either side of the vehicle is struck, or if the sensing system predicts that the vehicle is about to roll over on its side, or in a severe frontal impact.

In any particular crash, no one can say whether an airbag should have inflated simply because of the damage to a vehicle or because of what the repair costs were. For frontal airbags, inflation is determined by what the vehicle hits, the angle of the impact, and how quickly the vehicle slows down. For seat-mounted side impact and roof-rail airbags, deployment is determined by the location and severity of the side impact. In a

rollover event, roof-rail airbag deployment is determined by the direction of the roll.

### What Makes an Airbag Inflate?

In a deployment event, the sensing system sends an electrical signal triggering a release of gas from the inflator. Gas from the inflator fills the airbag causing the bag to break out of the cover and deploy. The inflator, the airbag, and related hardware are all part of the airbag module.

Frontal airbag modules are located inside the steering wheel and instrument panel. For vehicles with seat-mounted side impact airbags, there are airbags modules in the side of the front seatbacks closest to the door. For vehicles with roof-rail airbags, there are airbag modules in the ceiling of the vehicle, near the side windows that have occupant seating positions.

### How Does an Airbag Restrain?

In moderate to severe frontal or near frontal collisions, even belted occupants can contact the steering wheel or the instrument panel. In moderate to severe side collisions, even belted occupants can contact the inside of the vehicle.

Airbags supplement the protection provided by safety belts. Frontal airbags distribute the force of the impact more evenly over the occupant's upper body, stopping the occupant more gradually. Seat-mounted side impact and roof-rail airbags distribute the force of the impact more evenly over the occupant's upper body.

Rollover capable roof-rail airbags are designed to help contain the head and chest of occupants in the outboard seating positions in the first and second rows. The rollover capable roof-rail airbags are designed to help reduce the risk of

full or partial ejection in rollover events, although no system can prevent all such ejections.

But airbags would not help in many types of collisions, primarily because the occupant's motion is not toward those airbags. See *When Should an Airbag Inflate?* on page 3-24 for more information.

Airbags should never be regarded as anything more than a supplement to safety belts.

### What Will You See after an Airbag Inflates?

After the frontal airbags and seat-mounted side impact airbags inflate, they quickly deflate, so quickly that some people may not even realize an airbag inflated. Roof-rail airbags may still be at least partially inflated for some time after they deploy. Some components of the airbag module may be hot for several minutes. For location of the airbag modules, see *What Makes an Airbag Inflate?* on page 3-26.



The parts of the airbag that come into contact with you may be warm, but not too hot to touch. There may be some smoke and dust coming from the vents in the deflated airbags. Airbag inflation does not prevent the driver from seeing out of the windshield or being able to steer the vehicle, nor does it prevent people from leaving the vehicle.

 **WARNING**

When an airbag inflates, there may be dust in the air. This dust could cause breathing problems for people with a history of asthma or other breathing trouble. To avoid this, everyone in the vehicle should get out as soon as it is safe to do so. If you have breathing problems but cannot get out of the vehicle after an airbag inflates, then get fresh air by opening a window or a door. If you experience breathing

(Continued)

**WARNING (Continued)**

problems following an airbag deployment, you should seek medical attention.

The vehicle may have a feature that may automatically unlock the doors, turn on the interior lamps and hazard warning flashers, and shut off the fuel system after the airbags inflate. You can lock the doors, turn off the interior lamps and hazard warning flashers by using the controls for those features.

 **WARNING**

A crash severe enough to inflate the airbags may have also damaged important functions in the vehicle, such as the fuel system, brake and steering systems, etc. Even if the vehicle appears to be drivable after a

(Continued)

**WARNING (Continued)**

moderate crash, there may be concealed damage that could make it difficult to safely operate the vehicle.

Use caution if you should attempt to restart the engine after a crash has occurred.

In many crashes severe enough to inflate the airbag, windshields are broken by vehicle deformation. Additional windshield breakage may also occur from the right front passenger airbag.

- Airbags are designed to inflate only once. After an airbag inflates, you will need some new parts for the airbag system. If you do not get them, the airbag system will not be there to help protect you in another crash. A new system will include airbag modules and possibly

## 3-28 Seats and Restraints

other parts. The service manual for your vehicle covers the need to replace other parts.

- The vehicle has a crash sensing and diagnostic module which records information after a crash. See *Vehicle Data Recording and Privacy* on page 13-19 and *Event Data Recorders* on page 13-19.
- Let only qualified technicians work on the airbag systems. Improper service can mean that an airbag system will not work properly. See your dealer for service.

### Airbag On-Off Switch

If one of the switches pictured in the following illustrations is located in the glove box, the vehicle has an airbag on-off switch that you can use to manually turn on or off the right front passenger airbag.

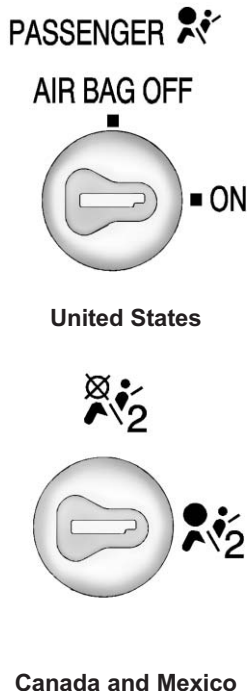

If the vehicle does not have an airbag off switch, it may have a passenger sensing system. See *Passenger Sensing System* on page 3-31.

This switch should only be turned to the off position if the person in the right front passenger position is a member of a passenger risk group identified by the national government as follows:

**Infant. An infant (less than 1 year old) must ride in the front seat because:**

- My vehicle has no rear seat;
- My vehicle has a rear seat too small to accommodate a rear-facing infant seat; or
- The infant has a medical condition which, according to the infant's physician, makes it necessary for the infant to ride in the front seat so that the driver can constantly monitor the child's condition.

**Child age 1 to 12. A child age 1 to 12 must ride in the front seat because:**

- My vehicle has no rear seat;
- Although children ages 1 to 12 ride in the rear seat(s) whenever possible, children ages 1 to 12 sometimes must ride in the front because no space is available in the rear seat(s) of my vehicle; or
- The child has a medical condition which, according to the child's physician, makes it necessary for the child to ride in the front seat so that the driver can constantly monitor the child's condition.

**Medical Condition. A passenger has a medical condition which, according to his or her physician:**

- Causes the passenger airbag to pose a special risk for the passenger; and

- *Makes the potential harm from the passenger airbag in a crash greater than the potential harm from turning off the airbag and allowing the passenger, even if belted, to hit the instrument panel or windshield in a crash.*

 <b>WARNING</b>
<p>If the right front passenger airbag is turned off for a person who is not in a risk group identified by the national government, that person will not have the extra protection of an airbag. In a crash, the airbag will not be able to inflate and help protect the person sitting there. Do not turn off the passenger airbag unless the person sitting there is in a risk group.</p>

PASSENGER 

AIR BAG OFF

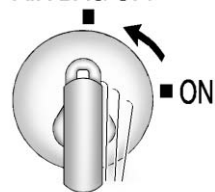

United States

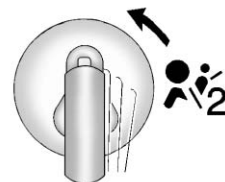

Canada and Mexico

## 3-30 Seats and Restraints

To turn off the right front passenger airbag, insert the ignition key into the switch, push in, and move the switch to the off position.

The word OFF or the off symbol will come on in the passenger airbag status indicator located in the overhead console to let you know that the right front passenger airbag is off, after the system check is completed. The airbag off light will come on and stay on to let you know that the right front passenger's airbag is off. See *Airbag On-Off Light* on page 5-18.

### **WARNING**

If the airbag readiness light ever comes on and stays on, it means that something may be wrong with the airbag system. For example, the right front passenger airbag could inflate even though the airbag on-off switch is turned off.

To help avoid injury to yourself or others, have the vehicle serviced right away. See *Airbag Readiness Light* on page 5-17 for more information, including important safety information.

PASSENGER 

**AIR BAG OFF**

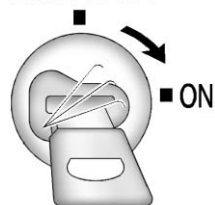

**United States**

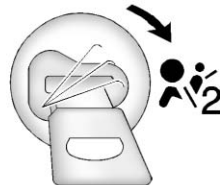

**Canada and Mexico**

To turn the right front passenger airbag on again, insert the ignition key into the switch, push in, and move the switch to the on position.

The right front passenger frontal airbag is now enabled (may inflate). See *Airbag On-Off Light on page 5-18* for more information.

## Passenger Sensing System

If the vehicle has one of the indicators pictured in the following illustrations, then the vehicle has a passenger sensing system for the right front passenger position, unless there is an airbag off switch located in the glove box. If there is an airbag off switch, the vehicle does not have a passenger sensing system. See *Airbag On-Off Switch on page 3-28* for more information.

The passenger airbag status indicator will be visible on the overhead console when the vehicle is started.

In addition, if the vehicle has a passenger sensing system for the right front passenger position, the label on the vehicle's sun visors refers to "ADVANCED AIRBAGS".



United States



Canada and Mexico

The words ON and OFF, or the symbol for on and off, will be visible during the system check. If you are using remote start to start the vehicle from a distance, if equipped, you may not see the system check. When the system check is complete, either the word ON or

OFF, or the symbol for on or off, will be visible. See *Passenger Airbag Status Indicator on page 5-19*.

The passenger sensing system will turn off the right front passenger frontal airbag under certain conditions. The driver airbag, seat-mounted side impact airbags (if equipped), and the roof-rail airbags (if equipped) are not affected by the passenger sensing system.

The passenger sensing system works with sensors that are part of the right front passenger seat and safety belt. The sensors are designed to detect the presence of a properly-seated occupant and determine if the right front passenger frontal airbag should be enabled (may inflate) or not.

According to accident statistics, children are safer when properly secured in a rear seat in the correct child restraint for their weight and size.

## 3-32 Seats and Restraints

We recommend that children be secured in a rear seat, including: an infant or a child riding in a rear-facing child restraint; a child riding in a forward-facing child seat; an older child riding in a booster seat; and children, who are large enough, using safety belts.

A label on the sun visor says, "Never put a rear-facing child seat in the front." This is because the risk to the rear-facing child is so great, if the airbag deploys.

### **WARNING**

A child in a rear-facing child restraint can be seriously injured or killed if the right front passenger airbag inflates. This is because the back of the rear-facing child restraint would be very close to the inflating airbag. A child in a forward-facing child restraint can be seriously injured or killed if the right front

(Continued)

### **WARNING (Continued)**

passenger airbag inflates and the passenger seat is in a forward position.

Even if the passenger sensing system has turned off the right front passenger frontal airbag, no system is fail-safe. No one can guarantee that an airbag will not deploy under some unusual circumstance, even though the airbag is turned off.

Secure rear-facing child restraints in a rear seat, even if the airbag is off. If you secure a forward-facing child restraint in the right front seat, always move the front passenger seat as far back as it will go. It is better to secure the child restraint in a rear seat.

If the vehicle does not have a rear seat that will accommodate a rear-facing child restraint, a rear-facing child restraint should not be installed in the vehicle, even if the airbag is off.

The passenger sensing system is designed to turn off the right front passenger frontal airbag if:

- The right front passenger seat is unoccupied.
- The system determines an infant is present in a child restraint.
- A right front passenger takes his/her weight off of the seat for a period of time.
- Or, if there is a critical problem with the airbag system or the passenger sensing system.

When the passenger sensing system has turned off the right front passenger frontal airbag, the off indicator will light and stay lit to remind you that the airbag is off. See *Passenger Airbag Status Indicator* on page 5-19.

The passenger sensing system is designed to turn on (may inflate) the right front passenger frontal airbag anytime the system senses that a person of adult size is sitting properly in the right front passenger seat.

When the passenger sensing system has allowed the airbag to be enabled, the on indicator will light and stay lit to remind you that the airbag is active.

For some children, including children in child restraints, and for very small adults, the passenger sensing system may or may not turn off the right front passenger frontal airbag, depending upon the person's seating posture and body build. Everyone in your vehicle who has outgrown child restraints should wear a safety belt properly — whether or not there is an airbag for that person.

 **WARNING**

If the airbag readiness light ever comes on and stays on, it means that something may be wrong with the airbag system. To help avoid injury to yourself or others, have the vehicle serviced right away. See *Airbag Readiness Light* on page 5-17 for more information, including important safety information.

**If the On Indicator is Lit for a Child Restraint**

If a child restraint has been installed and the on indicator is lit:

1. Turn the vehicle off.
2. Remove the child restraint from the vehicle.
3. Remove any additional items from the seat such as blankets, cushions, seat covers, seat heaters, or seat massagers.

4. Reinstall the child restraint following the directions provided by the child restraint manufacturer and refer to *Securing Child Restraints (Center Front Seat Position)* on page 3-56 or *Securing Child Restraints (Right Front Seat Position)* on page 3-57 or *Securing Child Restraints (Rear Seat Position)* on page 3-54.
5. If, after reinstalling the child restraint and restarting the vehicle, the on indicator is still lit, turn the vehicle off. Then slightly recline the vehicle seatback and adjust the seat cushion, if adjustable, to make sure that the vehicle seatback is not pushing the child restraint into the seat cushion.

Also make sure the child restraint is not trapped under the vehicle head restraint. If this happens, adjust the head restraint. See *Head Restraints* on page 3-2.

## 3-34 Seats and Restraints

---

- Restart the vehicle.

The passenger sensing system may or may not turn off the airbag for a child in a child restraint depending upon the child's seating posture and body build. It is better to secure the child restraint in a rear seat.

### If the Off Indicator is Lit for an Adult-Size Occupant



If a person of adult-size is sitting in the right front passenger seat, but the off indicator is lit, it could be because that person is not sitting properly in the seat. If this happens, use the following steps to allow the system to detect that person and enable the right front passenger frontal airbag:

- Turn the vehicle off.
- Remove any additional material from the seat, such as blankets, cushions, seat covers, seat heaters, or seat massagers.
- Place the seatback in the fully upright position.
- Have the person sit upright in the seat, centered on the seat cushion, with legs comfortably extended.
- Restart the vehicle and have the person remain in this position for two to three minutes after the on indicator is lit.

### Additional Factors Affecting System Operation

Safety belts help keep the passenger in position on the seat during vehicle maneuvers and braking, which helps the passenger sensing system maintain the passenger airbag status. See “Safety Belts” and “Child Restraints” in the Index for additional information about the importance of proper restraint use.

If the shoulder portion of the belt is pulled out all the way, the child restraint locking feature will be engaged. This may unintentionally cause the passenger sensing system to turn the airbag off for some adult size occupants. If this happens, let the belt go back all the way and start again.

A thick layer of additional material, such as a blanket or cushion, or aftermarket equipment such as seat covers, seat heaters, and seat massagers can affect how well the passenger sensing system



operates. We recommend that you not use seat covers or other aftermarket equipment except when approved by GM for your specific vehicle. See *Adding Equipment to the Airbag-Equipped Vehicle* on page 3-35 for more information about modifications that can affect how the system operates.

The on indicator may be lit if an object, such as a briefcase, handbag, grocery bag, laptop or other electronic device, is put on an unoccupied seat. If this is not desired, remove the object from the seat.

 **WARNING**

Stowing of articles under the passenger seat or between the passenger seat cushion and seatback may interfere with the proper operation of the passenger sensing system.

## Servicing the Airbag-Equipped Vehicle

Airbags affect how the vehicle should be serviced. There are parts of the airbag system in several places around the vehicle. Your dealer and the service manual have information about servicing the vehicle and the airbag system. To purchase a service manual, see *Service Publications Ordering Information* on page 13-16.

 **WARNING**

For up to 10 seconds after the vehicle is turned off and the battery is disconnected, an airbag can still inflate during improper service. You can be injured if you are close to an airbag when it inflates. Avoid yellow connectors.

(Continued)

**WARNING (Continued)**

They are probably part of the airbag system. Be sure to follow proper service procedures, and make sure the person performing work for you is qualified to do so.

## Adding Equipment to the Airbag-Equipped Vehicle

- Q:** Is there anything I might add to or change about the vehicle that could keep the airbags from working properly?
- A:** Yes. If you add things that change your vehicle's frame, bumper system, height, front end or side sheet metal, they may keep the airbag system from working properly. Changing or moving any parts of the front seats, safety belts, the airbag sensing and diagnostic module, steering wheel, instrument panel, roof-rail airbag modules,

ceiling headliner or pillar garnish trim, overhead console, front sensors, side impact sensors, or airbag wiring can affect the operation of the airbag system.

In addition, the vehicle may have a passenger sensing system for the right front passenger's position, which includes sensors that are part of the passenger's seat. The passenger sensing system may not operate properly if the original seat trim is replaced with non-GM covers, upholstery or trim, or with GM covers, upholstery or trim designed for a different vehicle. Any object, such as an aftermarket seat heater or a comfort enhancing pad or device, installed under or on top of the seat fabric, could also interfere with the operation of the passenger sensing system.

This could either prevent proper deployment of the passenger airbag(s) or prevent the passenger sensing system from properly turning off the passenger airbag(s). See *Passenger Sensing System on page 3-31*.

If you have any questions about this, you should contact Customer Assistance before you modify your vehicle. The phone numbers and addresses for Customer Assistance are in Step Two of the Customer Satisfaction Procedure in this manual. See *Customer Satisfaction Procedure (U.S. and Canada) on page 13-2* or *Customer Satisfaction Procedure (Mexico) on page 13-4*.

If the vehicle has rollover roof-rail airbags, see *Different Size Tires and Wheels on page 10-66* for additional important information.

**Q: What if I added a snow plow? Will it keep the airbags from working properly?**

**A:** We have designed our airbag systems to work properly under a wide range of conditions, including snow plowing with vehicles that have the optional Snow Plow Prep Package (RPO VYU). But do not change or defeat the snow plow's "tripping mechanism." If you do, it can damage your snow plow and your vehicle, and it may cause an airbag inflation.

**Q: Because I have a disability, I have to get my vehicle modified. How can I find out whether this will affect my airbag system?**

**A:** If you have questions, call Customer Assistance. The phone numbers and addresses for Customer Assistance are in Step Two of the Customer

Satisfaction Procedure in this manual. See *Customer Satisfaction Procedure (U.S. and Canada)* on page 13-2 or *Customer Satisfaction Procedure (Mexico)* on page 13-4.

In addition, your dealer and the service manual have information about the location of the airbag sensors, sensing and diagnostic module and airbag wiring.

## Airbag System Check

The airbag system does not need regularly scheduled maintenance or replacement. Make sure the airbag readiness light is working. See *Airbag Readiness Light* on page 5-17.

**Notice:** If an airbag covering is damaged, opened, or broken, the airbag may not work properly. Do not open or break the airbag coverings. If there are any opened or broken airbag covers, have the airbag covering and/or airbag module replaced. For the location of the airbags, see *Where Are the Airbags?* on page 3-22. See your dealer for service.

## Replacing Airbag System Parts after a Crash

### WARNING

A crash can damage the airbag systems in the vehicle. A damaged airbag system may not work properly and may not protect you and your

(Continued)

### WARNING (Continued)

passenger(s) in a crash, resulting in serious injury or even death. To help make sure the airbag systems are working properly after a crash, have them inspected and any necessary replacements made as soon as possible.

If an airbag inflates, you will need to replace airbag system parts. See your dealer for service.

If the airbag readiness light stays on after the vehicle is started or comes on when you are driving, the airbag system may not work properly. Have the vehicle serviced right away. See *Airbag Readiness Light* on page 5-17.

## Child Restraints

### Older Children

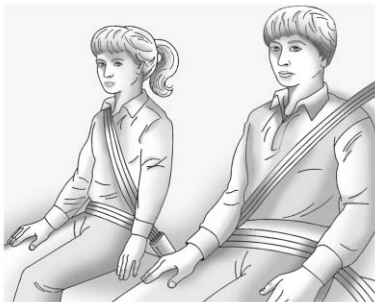

Older children who have outgrown booster seats should wear the vehicle safety belts.

The manufacturer instructions that come with the booster seat state the weight and height limitations for that booster. Use a booster seat with a lap-shoulder belt until the child passes the fit test below:

- Sit all the way back on the seat. Do the knees bend at the seat edge? If yes, continue. If no, return to the booster seat.
- Buckle the lap-shoulder belt. Does the shoulder belt rest on the shoulder? If yes, continue. If no, try using the rear safety belt comfort guide. See “Rear Safety Belt Comfort Guides” under *Lap-Shoulder Belt on page 3-13*. If the shoulder belt still does not rest on the shoulder, then return to the booster seat.
- Does the lap belt fit low and snug on the hips, touching the thighs? If yes, continue. If no, return to the booster seat.

- Can proper safety belt fit be maintained for the length of the trip? If yes, continue. If no, return to the booster seat.

**Q: What is the proper way to wear safety belts?**

**A:** An older child should wear a lap-shoulder belt and get the additional restraint a shoulder belt can provide. The shoulder belt should not cross the face or neck. The lap belt should fit snugly below the hips, just touching the top of the thighs. This applies belt force to the child's pelvic bones in a crash. It should never be worn over the abdomen, which could cause severe or even fatal internal injuries in a crash.

Also see “Rear Safety Belt Comfort Guides” under *Lap-Shoulder Belt on page 3-13*.

According to accident statistics, children and infants are safer when properly restrained in a child restraint system or infant restraint system secured in a rear seating position.

In a crash, children who are not buckled up can strike other people who are buckled up, or can be thrown out of the vehicle. Older children need to use safety belts properly.

**⚠ WARNING**

Never allow more than one child to wear the same safety belt. The safety belt cannot properly spread the impact forces. In a crash, they can be crushed together and seriously injured. A safety belt must be used by only one person at a time.



**⚠ WARNING**

Never allow a child to wear the safety belt with the shoulder belt behind their back. A child can be seriously injured by not wearing the lap-shoulder belt properly. In a crash, the child would not be restrained by the shoulder belt.

(Continued)

**WARNING (Continued)**

The child could move too far forward increasing the chance of head and neck injury. The child might also slide under the lap belt. The belt force would then be applied right on the abdomen. That could cause serious or fatal injuries. The shoulder belt should go over the shoulder and across the chest.



### Infants and Young Children

Everyone in a vehicle needs protection! This includes infants and all other children. Neither the distance traveled nor the age and size of the traveler changes the need, for everyone, to use safety restraints. In fact, the law in every state in the United States and in every Canadian province says children up to some age must be restrained while in a vehicle.

#### **WARNING**

Children can be seriously injured or strangled if a shoulder belt is wrapped around their neck and the safety belt continues to tighten. Never leave children unattended in a vehicle and never allow children to play with the safety belts.

Airbags plus lap-shoulder belts offer protection for adults and older children, but not for young children and infants. Neither the vehicle's safety belt system nor its airbag system is designed for them. Every time infants and young children ride in vehicles, they should have the protection provided by appropriate child restraints.

Children who are not restrained properly can strike other people, or can be thrown out of the vehicle.

#### **WARNING**

Never hold an infant or a child while riding in a vehicle. Due to crash forces, an infant or a child will become so heavy it is not possible to hold it during a crash. For example, in a crash at only 40 km/h (25 mph), a 5.5 kg (12 lb) infant will suddenly become a 110 kg (240 lb) force on a person's

(Continued)

#### **WARNING (Continued)**

arms. An infant should be secured in an appropriate restraint.



#### **WARNING**

Children who are up against, or very close to, any airbag when it inflates can be seriously injured or killed. Never put a rear-facing

(Continued)

**WARNING (Continued)**

child restraint in the right front seat. Secure a rear-facing child restraint in a rear seat. It is also better to secure a forward-facing child restraint in a rear seat. If you must secure a forward-facing child restraint in the right front seat, always move the front passenger seat as far back as it will go.



**Q: What are the different types of add-on child restraints?**

**A:** Add-on child restraints, which are purchased by the vehicle owner, are available in four basic types. Selection of a particular restraint should take into consideration not only the child's weight, height, and age but also whether or not the restraint will be compatible with the motor vehicle in which it will be used.

For most basic types of child restraints, there are many different models available. When purchasing a child restraint, be sure it is designed to be used in a motor vehicle. If it is, the restraint will have a label saying that it meets federal motor vehicle safety standards.

The restraint manufacturer instructions that come with the restraint state the weight and height limitations for a particular child restraint. In addition, there are many kinds of restraints available for children with special needs.

**⚠ WARNING**

To reduce the risk of neck and head injury during a crash, infants need complete support. In a crash, if an infant is in a rear-facing child restraint, the crash forces can be distributed across the strongest part of an infant's body, the back and shoulders. Infants should always be secured in rear-facing child restraints.

### **WARNING**

A young child's hip bones are still so small that the vehicle's regular safety belt may not remain low on the hip bones, as it should. Instead, it may settle up around the child's abdomen. In a crash, the belt would apply force on a body area that is unprotected by any bony structure. This alone could cause serious or fatal injuries. To reduce the risk of serious or fatal injuries during a crash, young children should always be secured in appropriate child restraints.

## Child Restraint Systems



### **Rear-Facing Infant Seat**

A rear-facing infant seat provides restraint with the seating surface against the back of the infant.

The harness system holds the infant in place and, in a crash, acts to keep the infant positioned in the restraint.



### **Forward-Facing Child Seat**

A forward-facing child seat provides restraint for the child's body with the harness.



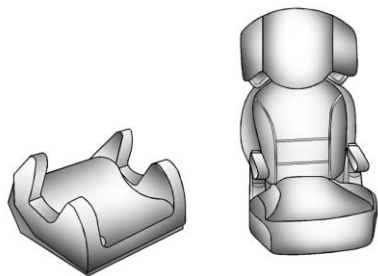

### Booster Seats

A booster seat is a child restraint designed to improve the fit of the vehicle's safety belt system. A booster seat can also help a child to see out the window.

### Securing an Add-On Child Restraint in the Vehicle

#### WARNING

A child can be seriously injured or killed in a crash if the child restraint is not properly secured in the vehicle. Secure the child restraint properly in the vehicle using the vehicle safety belt or LATCH system, following the instructions that came with that child restraint and the instructions in this manual.

To help reduce the chance of injury, the child restraint must be secured in the vehicle. Child restraint systems must be secured in vehicle seats by lap belts or the lap belt portion of a lap-shoulder belt, or by the LATCH system. See *Lower Anchors and Tethers for Children (LATCH System)* on page 3-45.

Children can be endangered in a crash if the child restraint is not properly secured in the vehicle.

When securing an add-on child restraint, refer to the instructions that come with the restraint which may be on the restraint itself or in a booklet, or both, and to this manual. The child restraint instructions are important, so if they are not available, obtain a replacement copy from the manufacturer.

Keep in mind that an unsecured child restraint can move around in a collision or sudden stop and injure people in the vehicle. Be sure to properly secure any child restraint in the vehicle — even when no child is in it.

In some areas of the United States and Canada, Certified Child Passenger Safety Technicians (CPSTs) are available to inspect and demonstrate how to correctly use and install child restraints. In the U.S., refer to the National Highway Traffic Safety

## 3-44 Seats and Restraints

Administration (NHTSA) website to locate the nearest child safety seat inspection station. For CPST availability in Canada, check with Transport Canada or the Provincial Ministry of Transportation office.

### Securing the Child Within the Child Restraint

#### WARNING

A child can be seriously injured or killed in a crash if the child is not properly secured in the child restraint. Secure the child properly following the instructions that came with that child restraint.

### Where to Put the Restraint

According to accident statistics, children and infants are safer when properly restrained in a child restraint system or infant restraint system secured in a rear seating position.

We recommend that children and child restraints be secured in a rear seat, including: an infant or a child riding in a rear-facing child restraint; a child riding in a forward-facing child seat; an older child riding in a booster seat; and children, who are large enough, using safety belts.

If a child restraint is secured in the right front passenger seat, and the vehicle has a switch in the glove box to manually turn off the right front passenger airbag, see *Airbag On-Off Switch* on page 3-28 and *Securing Child Restraints (Center Front Seat Position)* on page 3-56 or *Securing Child Restraints (Right Front Seat Position)* on page 3-57 or *Securing Child Restraints (Rear Seat Position)* on page 3-54 for more information, including important safety information.

A label on the sun visor says, "Never put a rear-facing child seat in the front." This is because the risk to the rear-facing child is so great, if the airbag deploys.

#### WARNING

A child in a rear-facing child restraint can be seriously injured or killed if the right front passenger airbag inflates. This is because the back of the rear-facing child restraint would be very close to the inflating airbag. A child in a forward-facing child restraint can be seriously injured or killed if the right front passenger airbag inflates and the passenger seat is in a forward position.

Even if the passenger sensing system or airbag switch has turned off the right front passenger frontal airbag, no system is fail-safe. No one can guarantee that an airbag will not deploy under some unusual circumstance, even though it is turned off.

(Continued)

**WARNING (Continued)**

Secure rear-facing child restraints in a rear seat, even if the airbag is off. If you secure a forward-facing child restraint in the right front seat, always move the front passenger seat as far back as it will go. It is better to secure the child restraint in a rear seat.

 **WARNING**

A child in a child restraint in the center front seat can be badly injured or killed by the frontal airbags if they inflate. Never secure a child restraint in the center front seat. It is always better to secure a child restraint in a rear seat.

Do not use child restraints in the center front seat position.

When securing a child restraint in a rear seating position, study the instructions that came with your child restraint to make sure it is compatible with this vehicle.

Child restraints and booster seats vary considerably in size, and some may fit in certain seating positions better than others. Always make sure the child restraint is properly secured.

Depending on where you place the child restraint and the size of the child restraint, you may not be able to access adjacent safety belt assemblies or LATCH anchors for additional passengers or child restraints. Adjacent seating positions should not be used if the child restraint prevents access to or interferes with the routing of the safety belt.

If the vehicle does not have a rear seat that will accommodate a rear-facing child restraint, a

rear-facing child restraint should not be installed in the vehicle, even if the airbag is off.

Wherever a child restraint is installed, be sure to secure the child restraint properly.

Keep in mind that an unsecured child restraint can move around in a collision or sudden stop and injure people in the vehicle. Be sure to properly secure any child restraint in your vehicle — even when no child is in it.

**Lower Anchors and Tethers for Children (LATCH System)**

The LATCH system secures a child restraint during driving or in a crash. LATCH attachments on the child restraint are used to attach the child restraint to the anchors in the vehicle. This system is designed to make installation of a child restraint easier.

## 3-46 Seats and Restraints

Make sure that a LATCH-compatible child restraint is properly installed using the anchors, or use the vehicle's safety belts to secure the restraint, following the instructions that came with that restraint, and also the instructions in this manual. When installing a child restraint with a top tether, you must also use either the lower anchors or the safety belts to properly secure the child restraint. A child restraint must never be installed using only the top tether and anchor.

In order to use the LATCH system in your vehicle, you need a child restraint that has LATCH attachments. The child restraint manufacturer will provide you with instructions on how to use the child restraint and its attachments. The following explains how to attach a child restraint with these attachments in your vehicle.

Not all vehicle seating positions or child restraints have lower anchors and attachments or top tether anchors and attachments.

### Lower Anchors

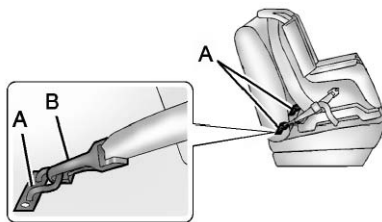

Lower anchors (A) are metal bars built into the vehicle. There are two lower anchors for each LATCH seating position that will accommodate a child restraint with lower attachments (B).

### Top Tether Anchor

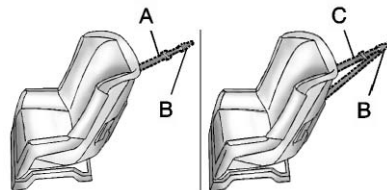

A top tether (A, C) anchors the top of the child restraint to the vehicle. A top tether anchor is built into the vehicle. The top tether attachment (B) on the child restraint connects to the top tether anchor in the vehicle in order to reduce the forward movement and rotation of the child restraint during driving or in a crash.

Your child restraint may have a single tether (A) or a dual tether (C). Either will have a single attachment (B) to secure the top tether to the anchor.

Some child restraints that have a top tether are designed for use with or without the top tether being attached. Others require the top tether always to be attached. In Canada, the law requires that forward-facing child restraints have a top tether, and that the tether be attached. Be sure to read and follow the instructions for your child restraint.

**Lower Anchor and Top Tether Anchor Locations**

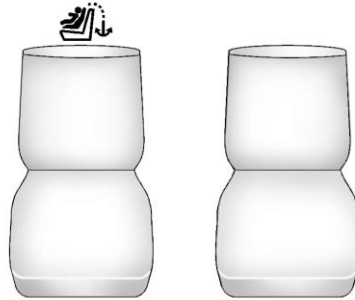

**Regular Cab — Two-Passenger Front Seat**

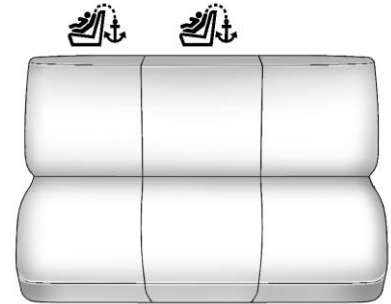

**Regular Cab — Three-Passenger Front Seat**

 **(Top Tether Anchor):** Seating positions with top tether anchors.

Do not install a child restraint in the center front seat position. See *Securing Child Restraints (Center Front Seat Position)* on page 3-56 or *Securing Child Restraints (Right Front Seat Position)* on page 3-57 or *Securing Child Restraints (Rear Seat Position)* on page 3-54 for more information.

## 3-48 Seats and Restraints

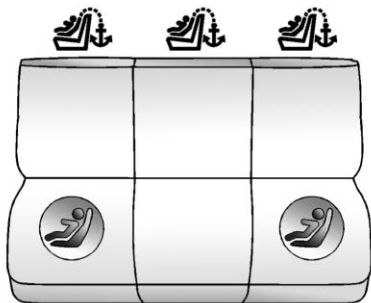

### Crew and Extended Cab Rear Seat

 **(Top Tether Anchor):** Seating positions with top tether anchors.

 **(Lower Anchor):** Seating positions with two lower anchors.

For crew and extended cab models, the rear outboard seating positions have exposed metal lower anchors located in the crease between the seatback and the seat cushion.



For regular cab models, there is an anchor symbol on the covers to assist you in locating the top tether anchors.

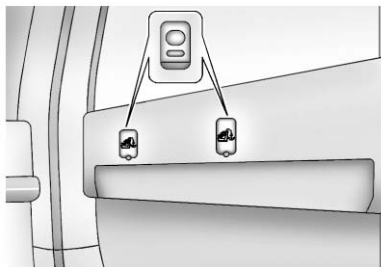

**Regular Cab**

Do not install a child restraint in the center seat position. See *Securing Child Restraints (Center Front Seat Position)* on page 3-56 or *Securing Child Restraints (Right Front Seat Position)* on page 3-57 or *Securing Child Restraints (Rear Seat Position)* on page 3-54 for more information.

For regular cab models, the top tether anchors are located under the covers on the back panel behind the passenger seat. Remove the trim plug to access the anchor. Be sure to use an anchor located on the same side of the vehicle as the seating position where the child restraint will be placed.

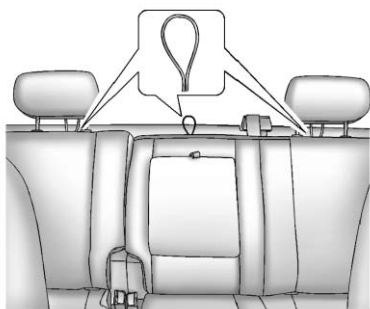

### Crew Cab Shown, Extended Cab Similar

For crew and extended cab models, the top tether anchors are the loops located near the top of the seatback for each rear seating position.

These loops will be used to route the top tether through, as well as, to secure the top tether in the vehicle.

Be sure to use an anchor (loop) located on the same side of the vehicle as the seating position where the child restraint will be placed.

Be sure to read the instructions following to properly install a child restraint using these loops.

Do not secure a child restraint in a position without a top tether anchor if a national or local law requires that the top tether be attached, or if the instructions that come with the child restraint say that the top tether must be attached.

According to accident statistics, children and infants are safer when properly restrained in a child restraint system or infant restraint system secured in a rear seating position. See *Where to Put the Restraint on page 3-44* for additional information.

### Securing a Child Restraint Designed for the LATCH System

#### WARNING

If a LATCH-type child restraint is not attached to anchors, the child restraint will not be able to protect the child correctly. In a crash, the child could be seriously injured or killed. Install a LATCH-type child restraint properly using the anchors, or use the vehicle safety belts to secure the restraint, following the instructions that came with the child restraint and the instructions in this manual.

### WARNING

Do not attach more than one child restraint to a single anchor, except for the center top tether anchors in the crew and extended cabs. Attaching more than one child restraint to a single anchor could cause the anchor or attachment to come loose or even break during a crash. A child or others could be injured. To reduce the risk of serious or fatal injuries during a crash, attach only one child restraint per anchor.

### WARNING

Children can be seriously injured or strangled if a shoulder belt is wrapped around their neck and the safety belt continues to tighten. Buckle any unused safety belts behind the child restraint so

(Continued)

### WARNING (Continued)

children cannot reach them. Pull the shoulder belt all the way out of the retractor to set the lock, if the vehicle has one, after the child restraint has been installed.

**Notice: Do not let the LATCH attachments rub against the vehicle's safety belts. This may damage these parts. If necessary, move buckled safety belts to avoid rubbing the LATCH attachments.**

**Do not fold the empty rear seat with a safety belt buckled. This could damage the safety belt or the seat. Unbuckle and return the safety belt to its stowed position, before folding the seat.**

If you need to secure more than one child restraint in the rear seat, see *Where to Put the Restraint on page 3-44*.

This system is designed to make installation of child restraints easier. When using lower anchors, do not use the vehicle's safety belts. Instead use the vehicle's anchors and child restraint attachments to secure the restraints. Some restraints also use another vehicle anchor to secure a top tether.

### Regular Cab Models

1. If the child restraint manufacturer recommends that the top tether be attached, attach and tighten the top tether to the top tether anchor, if your vehicle has one. Refer to the child restraint instructions and the following steps:
  - 1.1. Pull the passenger seatback forward by pulling the recliner handle upward to access the top tether anchor. See *Reclining Seatbacks on page 3-5* for additional information.
  - 1.2. Find the top tether anchor.



- 1.3. Remove the cover to expose the anchor.
- 1.4. Route, attach, and tighten the top tether according to your child restraint instructions and the following instructions:

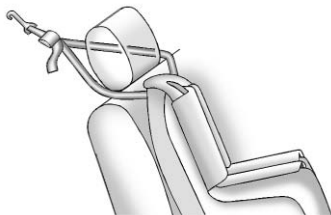

If the position you are using has an adjustable headrest or head restraint and you are using a dual tether, route the tether around the headrest or head restraint.

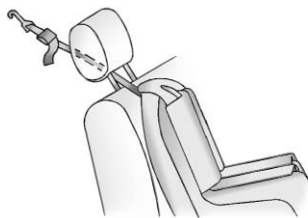

If the position you are using has an adjustable headrest or head restraint and you are using a single tether, raise the headrest or head restraint and route the tether under the headrest or head restraint and in between the headrest or head restraint posts.

2. See *Securing Child Restraints (Center Front Seat Position)* on page 3-56 or *Securing Child Restraints (Right Front Seat Position)* on page 3-57 or *Securing Child Restraints (Rear Seat Position)* on page 3-54 for instructions on installing the child restraint using the safety belts.
3. Before placing a child in the child restraint, make sure it is securely held in place. To check, grasp the child restraint at the LATCH path and attempt to move it side-to-side and back-and-forth. There should be no more than 2.5 cm (1 in) of movement for proper installation.

## 3-52 Seats and Restraints

### Crew and Extended Cab Models

1. Attach and tighten the lower attachments to the lower anchors. If the child restraint does not have lower attachments or the desired seating position does not have lower anchors, secure the child restraint with the top tether and the safety belts. Refer to your child restraint manufacturer instructions and the instructions in this manual.
  - 1.1. Find the lower anchors for the desired seating position.
  - 1.2. Put the child restraint on the seat.
  - 1.3. Attach and tighten the lower attachments on the child restraint to the lower anchors.

2. If the child restraint manufacturer recommends that the top tether be attached, attach and tighten the top tether to the top tether anchor (loop), if your vehicle has one. Refer to the child restraint instructions and the following steps:

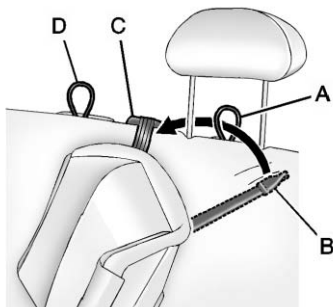

**Example — Rear Driver Side Position**

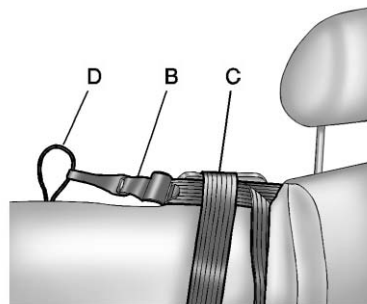

**Example — Rear Driver Side Position**

- 2.1. When using a child restraint with a top tether in the rear driver side position:
  - A. Raise the headrest or head restraint.

- |   |  |  |
|---|--|--|
| <p>B. Route the top tether (B) between the headrest or head restraint posts, through the loop (A), behind the inboard headrest or head restraint post, and under the center shoulder belt (C).</p> <p>C. Attach the top tether (B) to the top tether anchor (loop) (D) at the center rear seating position.</p> | <p>B. Attach the top tether (B) to the top tether anchor (loop) at the rear passenger side seating position.</p>   | <p>C. Attach the top tether (B) to the top tether anchor (loop) (D) at the center rear seating position.</p>   |
| <p>2.2. When using a child restraint with a top tether in the rear center position:</p> <p>A. Route the top tether (B) through the center loop (D), and behind the inboard passenger side headrest or head restraint post.</p>  | <p>2.3. When using a child restraint with a top tether in the rear passenger position:</p> <p>A. Raise the headrest or head restraint.</p> <p>B. Route the top tether (B) between the headrest or head restraint posts, through the loop on the passenger side and behind the inboard headrest or head restraint post.</p> | <p>2.4. Tighten the top tether when and as the child restraint manufacturer's instructions say.</p> <p>When the top tether is tightened, the anchor (loop) may bend. This is normal and will not damage the vehicle.</p>   |
|   |  | <p>3. Before placing a child in the child restraint, make sure it is securely held in place. To check, grasp the child restraint at the LATCH path and attempt to move it side-to-side and back-and-forth. There should be no more than 2.5 cm (1 in) of movement for proper installation.</p> |

### Replacing LATCH System Parts After a Crash

 **WARNING**

A crash can damage the LATCH system in the vehicle. A damaged LATCH system may not properly secure the child restraint, resulting in serious injury or even death in a crash. To help make sure the LATCH system is working properly after a crash, see your dealer to have the system inspected and any necessary replacements made as soon as possible.

If the vehicle has the LATCH system and it was being used during a crash, new LATCH system parts may be needed.

New parts and repairs may be necessary even if the LATCH system was not being used at the time of the crash.

### Securing Child Restraints (Rear Seat Position)

When securing a child restraint in a rear seating position, study the instructions that came with the child restraint to make sure it is compatible with this vehicle.

If the child restraint has the LATCH system, see *Lower Anchors and Tethers for Children (LATCH System)* on page 3-45 for how and where to install the child restraint using LATCH. If a child restraint is secured in the vehicle using a safety belt and it uses a top tether, see *Lower Anchors and Tethers for Children (LATCH System)* on page 3-45 for top tether anchor locations.

Do not secure a child seat in a position without a top tether anchor if a national or local law requires that the top tether be anchored, or if the instructions that come with the child restraint say that the top strap must be anchored.

In Canada, the law requires that forward-facing child restraints have a top tether, and that the tether be attached.

If the child restraint does not have the LATCH system, you will be using the safety belt to secure the child restraint in this position. Be sure to follow the instructions that came with the child restraint. Secure the child in the child restraint when and as the instructions say.

If more than one child restraint needs to be installed in the rear seat, be sure to read *Where to Put the Restraint* on page 3-44.

1. Put the child restraint on the seat.

2. Pick up the latch plate, and run the lap and shoulder portions of the vehicle's safety belt through or around the restraint. The child restraint instructions will show you how.

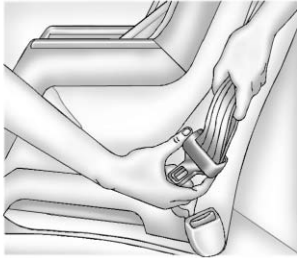

For crew cab second row seatings positions, tilt the latch plate to adjust the belt if needed.

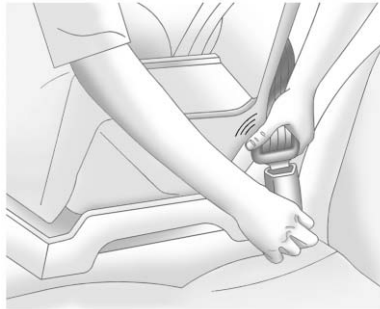

3. Push the latch plate into the buckle until it clicks.  
Position the release button on the buckle so that the safety belt could be quickly unbuckled if necessary.



4. Pull the shoulder belt all the way out of the retractor to set the lock. When the retractor lock is set, the belt can be tightened but not pulled out of the retractor.

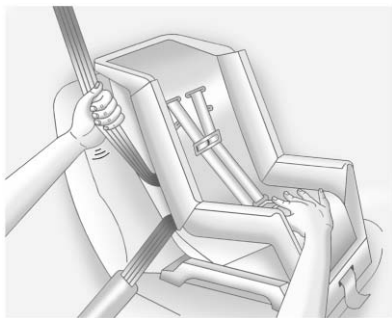

5. To tighten the belt, push down on the child restraint, pull the shoulder portion of the belt to tighten the lap portion of the belt, and feed the shoulder belt back into the retractor. When installing a forward-facing child restraint, it may be helpful to use your knee to push down on the child restraint as you tighten the belt.

Try to pull the belt out of the retractor to make sure the retractor is locked. If the retractor is not locked, repeat Steps 4 and 5.

6. If the child restraint has a top tether, follow the child restraint manufacturer's instructions regarding the use of the top tether. See *Lower Anchors and Tethers for Children (LATCH System)* on page 3-45 for more information.
7. Before placing a child in the child restraint, make sure it is securely held in place. To check, grasp the child restraint at the safety belt path and attempt to move it side-to-side and back-and-forth. When the child restraint is properly installed, there should be no more than 2.5 cm (1 in) of movement.

To remove the child restraint, unbuckle the vehicle safety belt and let it return to the stowed position. If the top tether is attached to a top tether anchor, disconnect it.

### Securing Child Restraints (Center Front Seat Position)

#### WARNING

A child in a child restraint in the center front seat can be badly injured or killed by the frontal airbags if they inflate. Never secure a child restraint in the center front seat. It is always better to secure a child restraint in a rear seat.

Do not use child restraints in the center front seat position.

## Securing Child Restraints (Right Front Seat Position)

### With Passenger Sensing System

This vehicle has airbags. A rear seat is a safer place to secure a forward-facing child restraint. See *Where to Put the Restraint on page 3-44*.

In addition, the vehicle may have a passenger sensing system which is designed to turn off the right front passenger frontal airbag under certain conditions. See *Passenger Sensing System on page 3-31* and *Passenger Airbag Status Indicator on page 5-19* for more information on this, including important safety information.

A label on the sun visor says, "Never put a rear-facing child seat in the front." This is because the risk to the rear-facing child is so great, if the airbag deploys.

### WARNING

A child in a rear-facing child restraint can be seriously injured or killed if the right front passenger airbag inflates. This is because the back of the rear-facing child restraint would be very close to the inflating airbag. A child in a forward-facing child restraint can be seriously injured or killed if the right front passenger airbag inflates and the passenger seat is in a forward position.

The vehicle may have a passenger sensing system which is designed to turn off the right front passenger frontal airbag under certain conditions.

Even if the passenger sensing system, if equipped, has turned off the right front passenger frontal airbag, no system is

(Continued)

### WARNING (Continued)

fail-safe. No one can guarantee that an airbag will not deploy under some unusual circumstance, even though it is turned off.

Secure rear-facing child restraints in a rear seat, even if the airbag is off. If you secure a forward-facing child restraint in the right front seat, always move the front passenger seat as far back as it will go. It is better to secure the child restraint in a rear seat.

See *Passenger Sensing System on page 3-31* for additional information.

If the vehicle does not have a rear seat that will accommodate a rear-facing child restraint, a rear-facing child restraint should not be installed in the vehicle, even if the airbag is off.

## 3-58 Seats and Restraints

---

If the child restraint has the LATCH system, see *Lower Anchors and Tethers for Children (LATCH System)* on page 3-45 for how and where to install the child restraint using LATCH. If you secure a child restraint using a safety belt and it uses a top tether, see *Lower Anchors and Tethers for Children (LATCH System)* on page 3-45 for top tether anchor locations.

Do not secure a child seat in a position without a top tether anchor if a national or local law requires that the top tether be anchored, or if the instructions that come with the child restraint say that the top strap must be anchored.

In Canada, the law requires that forward-facing child restraints have a top tether, and that the tether be attached.

You will be using the lap-shoulder belt to secure the child restraint in this position. Follow the instructions that came with the child restraint.

1. Move the seat as far back as it will go before securing the forward-facing child restraint.

When the passenger sensing system, if equipped, has turned off the right front passenger frontal airbag, the off indicator in the passenger airbag status indicator should light and stay lit when you start the vehicle. See *Passenger Airbag Status Indicator* on page 5-19.

2. Put the child restraint on the seat.
3. Pick up the latch plate, and run the lap and shoulder portions of the vehicle's safety belt through or around the restraint. The child restraint instructions will show you how.

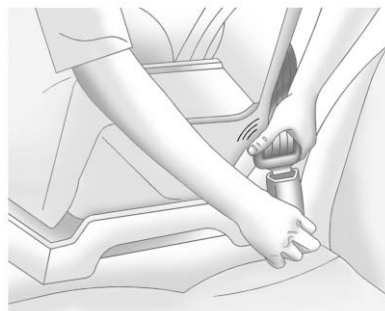

4. Push the latch plate into the buckle until it clicks.

Position the release button so that the safety belt could be quickly unbuckled if necessary.





5. Pull the shoulder belt all the way out of the retractor to set the lock. When the retractor lock is set, the belt can be tightened but not pulled out of the retractor.

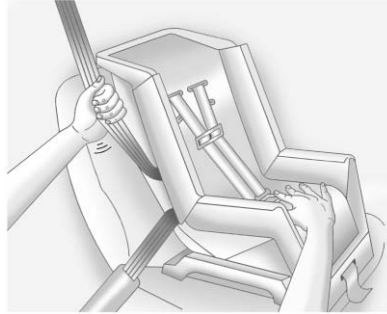

6. To tighten the belt, push down on the child restraint, pull the shoulder portion of the belt to tighten the lap portion of the belt, and feed the shoulder belt back into the retractor. When installing a forward-facing child restraint, it may be helpful to use your knee to push down on the child restraint as you tighten the belt.

Try to pull the belt out of the retractor to make sure the retractor is locked. If the retractor is not locked, repeat Steps 5 and 6.

7. If the vehicle does not have a rear seat and the child restraint has a top tether, follow the child restraint manufacturer's instructions regarding the use of the top tether. See *Lower Anchors and Tethers for Children (LATCH System)* on page 3-45 for more information.
8. Before placing a child in the child restraint, make sure it is securely held in place. To check, grasp the child restraint at the safety belt path and attempt to move it side to side and back and forth. When the child restraint is properly installed, there should be no more than 2.5 cm (1 in) of movement.

If the vehicle is equipped with a passenger sensing system, and when the passenger sensing system has turned off the right front passenger frontal airbag, the off indicator in the passenger airbag status indicator should light and stay lit when you start the vehicle.

## 3-60 Seats and Restraints

If a child restraint has been installed and the on indicator is lit, see “If the On Indicator is Lit for a Child Restraint” under *Passenger Sensing System on page 3-31* for more information.

To remove the child restraint, unbuckle the vehicle safety belt and let it return to the stowed position. If the top tether is attached to a top tether anchor, disconnect it.

### With Airbag Off Switch

This vehicle has airbags. A rear seat is a safer place to secure a forward-facing child restraint. See *Where to Put the Restraint on page 3-44*.

There may be a switch in the glove box that you can use to turn off the right front passenger frontal airbag. See *Airbag On-Off Switch on page 3-28* for more information, including important safety information.

A label on the sun visor says, “Never put a rear-facing child seat in the front unless airbag is off.” This is because the risk to the rear-facing child is so great, if the airbag deploys.



### WARNING

A child in a rear-facing child restraint can be seriously injured or killed if the right front passenger airbag inflates. This is because the back of the rear-facing child restraint would be very close to the inflating airbag. A child in a forward-facing child restraint can be seriously injured or killed if the right front passenger airbag inflates and the passenger seat is in a forward position.

(Continued)

### WARNING (Continued)

Even if the airbag switch has turned off the right front passenger frontal airbag, no system is fail-safe. No one can guarantee that an airbag will not deploy under some unusual circumstance, even though it is turned off.

Secure rear-facing child restraints in a rear seat, even if the airbag is off. If you secure a forward-facing child restraint in the right front seat, always move the front passenger seat as far back as it will go. It is better to secure the child restraint in a rear seat.

 **WARNING**

If the airbag readiness light ever comes on and stays on, it means that something may be wrong with the airbag system. For example, the right front passenger airbag could inflate even though the airbag on-off switch is turned off.

To help avoid injury to yourself or others, have the vehicle serviced right away. See *Airbag Readiness Light on page 5-17* for more information, including important safety information.

If the vehicle does not have a rear seat that will accommodate a rear-facing child restraint, a rear-facing child restraint should not be installed in the vehicle, even if the airbag is off.

If the child restraint has the LATCH system, see *Lower Anchors and Tethers for Children (LATCH System) on page 3-45* for how and where to install the child restraint using LATCH. If a child restraint is secured using a safety belt and it uses a top tether, see *Lower Anchors and Tethers for Children (LATCH System) on page 3-45* for top tether anchor locations.

Do not secure a child restraint in a position without a top tether anchor if a national or local law requires that the top tether be anchored, or if the instructions that come with the child restraint say that the top strap must be anchored.

In Canada, the law requires that forward-facing child restraints have a top tether, and that the tether be attached.

You will be using the lap-shoulder belt to secure the child restraint in this position. Follow the instructions that came with the child restraint.

1. Move the seat as far back as it will go before securing the forward-facing child restraint.

If you have no other choice but to install a rear-facing child restraint in this seat, make sure the airbag is off once the child restraint has been installed.

When the airbag off switch has turned off the right front passenger frontal airbag, the off indicator in the airbag off light should light and stay lit when you start the vehicle. See *Airbag On-Off Light on page 5-18*.

2. Put the child restraint on the seat.
3. Pick up the latch plate, and run the lap and shoulder portions of the vehicle's safety belt through or around the restraint. The child restraint instructions will show you how.

## 3-62 Seats and Restraints

---

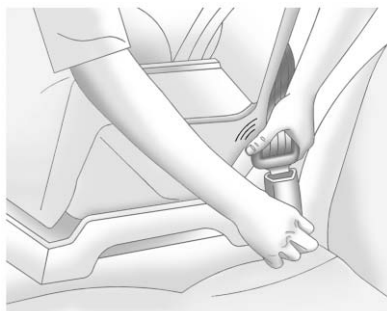

4. Push the latch plate into the buckle until it clicks.

Position the release button so that the safety belt could be quickly unbuckled if necessary.



5. Pull the shoulder belt all the way out of the retractor to set the lock. When the retractor lock is set, the belt can be tightened but not pulled out of the retractor.

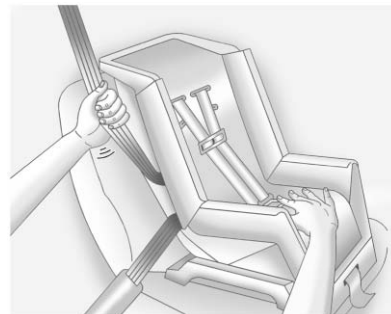

6. To tighten the belt, push down on the child restraint, pull the shoulder portion of the belt to tighten the lap portion of the belt, and feed the shoulder belt back into the retractor. When installing a forward-facing child restraint, it may be helpful to use your knee to push down on the child restraint as you tighten the belt.

Try to pull the belt out of the retractor to make sure the retractor is locked. If the retractor is not locked, repeat Steps 5 and 6.

7. If your vehicle does not have a rear seat and your child restraint has a top tether, follow the child restraint manufacturer's instructions regarding the use of the top tether. See *Lower Anchors and Tethers for Children (LATCH System)* on page 3-45.
8. Before placing a child in the child restraint, make sure it is securely held in place. To check, grasp the child restraint at the safety belt path and attempt to move it side to side and back and forth. When the child restraint is properly installed, there should be no more than 2.5 cm (1 in) of movement.

To remove the child restraint, unbuckle the vehicle safety belt and let it return to the stowed position. If the top tether is attached to a top tether anchor, disconnect it.

If you turned the airbag off with the switch, turn on the right front passenger airbag when you remove the child restraint from the vehicle unless the person who will be sitting there is a member of a passenger airbag risk group. See *Airbag On-Off Switch* on page 3-28 for more information, including important safety information.

### Heavy Duty Crew Cab Only

This vehicle has airbags. A rear seat is a safer place to secure a forward-facing child restraint. See *Where to Put the Restraint* on page 3-44.

A label on the sun visor says, "Never put a rear-facing child seat in the front." This is because the risk to the rear-facing child is so great, if the airbag deploys.

Never put a rear-facing child restraint in the right front passenger seat. Here is why:

### WARNING

A child in a rear-facing child restraint can be seriously injured or killed if the right front passenger's airbag inflates. This is because the back of the rear-facing child restraint would be very close to the inflating airbag. Always secure a rear-facing child restraint in a rear seat.

If the vehicle does not have a rear seat that will accommodate a rear-facing child restraint, a rear-facing child restraint should not be installed in the vehicle, even if the airbag is off.

## 3-64 Seats and Restraints

If the child restraint has the LATCH system, see *Lower Anchors and Tethers for Children (LATCH System)* on page 3-45 for how and where to install the child restraint using LATCH. If you secure a child restraint using a safety belt and it uses a top tether, see *Lower Anchors and Tethers for Children (LATCH System)* on page 3-45 for top tether anchor locations.

Do not secure a child seat in a position without a top tether anchor if a national or local law requires that the top tether be anchored, or if the instructions that come with the child restraint say that the top strap must be anchored.

In Canada, the law requires that forward-facing child restraints have a top tether, and that the tether be attached.

You will be using the lap-shoulder belt to secure the child restraint in this position. Follow the instructions that came with the child restraint.

1. Move the seat as far back as it will go before securing the forward-facing child restraint.
2. Put the child restraint on the seat.
3. Pick up the latch plate, and run the lap and shoulder portions of the vehicle's safety belt through or around the restraint. The child restraint instructions will show you how.

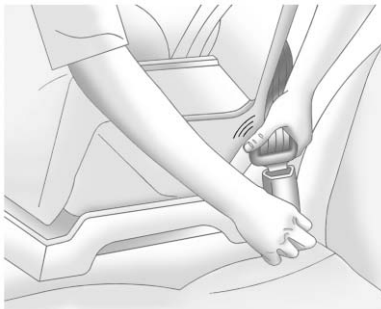

4. Push the latch plate into the buckle until it clicks.

Make sure the release button is positioned so you would be able to unbuckle the safety belt quickly if necessary.



5. Pull the shoulder belt all the way out of the retractor to set the lock. When the retractor lock is set, the belt can be tightened but not pulled out of the retractor.

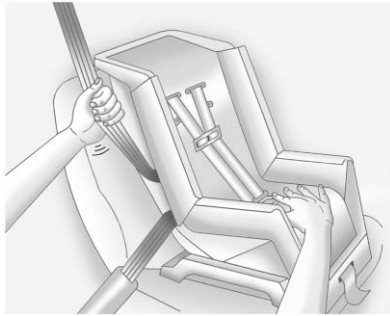

6. To tighten the belt, push down on the child restraint, pull the shoulder portion of the belt to tighten the lap portion of the belt, and feed the shoulder belt back into the retractor. When installing a forward-facing child restraint, it may be helpful to use your knee to push down on the child restraint as you tighten the belt.  
Try to pull the belt out of the retractor to make sure the retractor is locked. If the retractor is not locked, repeat Steps 5 and 6.
7. If your child restraint has a top tether, follow the child restraint manufacturer's instructions regarding the use of the top tether. See *Lower Anchors and Tethers for Children (LATCH System)* on page 3-45 for more information.
8. Before placing a child in the child restraint, make sure it is securely held in place. To check, grasp the child restraint at the safety belt path and attempt to move it side to side and back and forth. When the child restraint is properly installed, there should be no more than 2.5 cm (1 in) of movement.

To remove the child restraint, unbuckle the vehicle safety belt and let it return to the stowed position. If the top tether is attached to a top tether anchor, disconnect it.





## Storage

### Storage Compartments

Instrument Panel Storage . . . . .	4-1
Glove Box . . . . .	4-1
Cupholders . . . . .	4-1
Armrest Storage . . . . .	4-1
Center Console Storage . . . . .	4-2

## Storage Compartments

### Instrument Panel Storage

For vehicles equipped with an instrument panel storage area, it is located above the glove box.

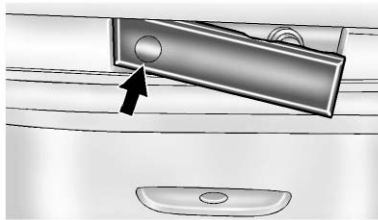

Access the storage area by pressing and holding in the driver side of the handle and pull out on the exposed portion of the handle.

## Glove Box

Lift up on the glove box lever to open it.

## Cupholders

If equipped, there are cupholders on the center console and the rear of the center console, also in the rear seat armrest.

Pull the cover down on the rear of the center console to access the cupholders in the rear of the center console.

Pull the rear seat armrest down to access the cupholders.

## Armrest Storage

Vehicles with a rear seat armrest have two cupholders. Pull the armrest down from the rear seatback to access the cupholders.

## 4-2 Storage

---

### Center Console Storage

Vehicles with an upper and lower center console storage area have cupholders included.

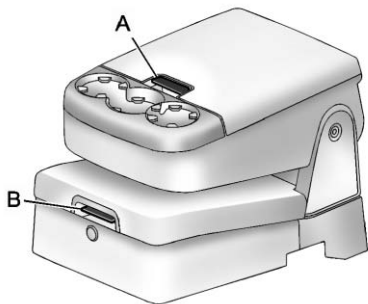

Pull the lever (A) up to access the upper storage area. Raise the upper storage bin, then pull the lever (B) up to access the lower storage area. Use the key to lock and unlock the lower storage area.

## Instruments and Controls

### Controls

Steering Wheel Adjustment . . .	5-2
Steering Wheel Controls . . . . .	5-2
Horn . . . . .	5-4
Windshield Wiper/Washer . . . . .	5-4
Compass . . . . .	5-5
Clock . . . . .	5-7
Power Outlets . . . . .	5-9
Cigarette Lighter . . . . .	5-9
Ashtrays . . . . .	5-10

### Warning Lights, Gauges, and Indicators

Warning Lights, Gauges, and Indicators . . . . .	5-10
Instrument Cluster . . . . .	5-11
Speedometer . . . . .	5-12
Odometer . . . . .	5-12
Trip Odometer . . . . .	5-12
Tachometer . . . . .	5-12
Fuel Gauge . . . . .	5-13
Engine Oil Pressure Gauge . . . . .	5-14

Engine Coolant Temperature Gauge . . . . .	5-15
Voltmeter Gauge . . . . .	5-15
Safety Belt Reminders . . . . .	5-16
Airbag Readiness Light . . . . .	5-17
Airbag On-Off Light . . . . .	5-18
Passenger Airbag Status Indicator . . . . .	5-19
Charging System Light . . . . .	5-20
Malfunction Indicator Lamp . . . . .	5-21
Brake System Warning Light . . . . .	5-23
Antilock Brake System (ABS) Warning Light . . . . .	5-24
Four-Wheel-Drive Light . . . . .	5-25
Tow/Haul Mode Light . . . . .	5-25
StabiliTrak <sup>®</sup> OFF Light . . . . .	5-25
Traction Control System (TCS)/StabiliTrak <sup>®</sup> Light . . . . .	5-26
Tire Pressure Light . . . . .	5-26
Engine Oil Pressure Light . . . . .	5-26
Low Fuel Warning Light . . . . .	5-27
Security Light . . . . .	5-27
High-Beam On Light . . . . .	5-28
Front Fog Lamp Light . . . . .	5-28
Cruise Control Light . . . . .	5-28

### Information Displays

Driver Information Center (DIC) . . . . .	5-28
---	------

### Vehicle Messages

Vehicle Messages . . . . .	5-37
Battery Voltage and Charging Messages . . . . .	5-37
Brake System Messages . . . . .	5-38
Door Ajar Messages . . . . .	5-38
Engine Cooling System Messages . . . . .	5-39
Engine Oil Messages . . . . .	5-40
Engine Power Messages . . . . .	5-40
Fuel System Messages . . . . .	5-41
Key and Lock Messages . . . . .	5-41
Lamp Messages . . . . .	5-41
Object Detection System Messages . . . . .	5-41
Ride Control System Messages . . . . .	5-42
Airbag System Messages . . . . .	5-43
Security Messages . . . . .	5-43
Starting the Vehicle Messages . . . . .	5-43
Tire Messages . . . . .	5-43

## 5-2 Instruments and Controls

Transmission Messages . . . . .	5-44
Vehicle Reminder Messages . . . . .	5-45
Washer Fluid Messages . . . . .	5-46

### Vehicle Personalization

Vehicle Personalization (With DIC Buttons) . . . . .	5-46
---	------

### Universal Remote System

Universal Remote System . . .	5-54
Universal Remote System Programming . . . . .	5-54
Universal Remote System Operation . . . . .	5-58

## Controls

### Steering Wheel Adjustment

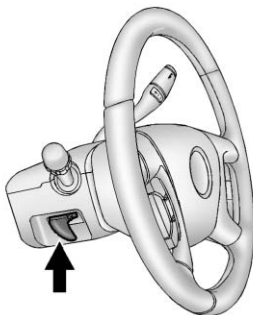

To adjust the steering wheel:

1. Hold the steering wheel and pull the lever.
2. Move the steering wheel up or down.
3. Release the lever to lock the wheel in place.

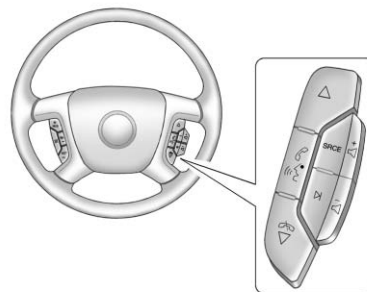

Do not adjust the steering wheel while driving.

### Steering Wheel Controls





If equipped, some audio controls can be adjusted at the steering wheel.

**△ (Next):** Press to go to the next favorite radio station, track on a CD, or folder on an iPod® or USB device.

 /  (**Previous/End**): Press to go to the previous favorite radio station, track on a CD, or folder on an iPod® or USB device. Press to reject an incoming call, or end a current call.



### Radio

To select preset or favorite radio stations:



Press and release  or  /  to go to the next or previous radio station stored as a preset or favorite.





### CD/DVD

To select tracks on a CD/DVD:













Press and release  or  /  to go to the next or previous track.

### Selecting Tracks on an iPod or USB Device (Vehicles without a Navigation System)







1. Press and hold  or  /  while listening to a song until the contents of the current folder display on the radio display.

2. Press and release  or  /  to scroll up or down the list, then press and hold , or press  to play the highlighted track.







### Navigating Folders on an iPod or USB Device (Vehicles without a Navigation System):

1. Press and hold  or  /  while listening to a song until the contents of the current folder display on the radio display.
2. Press and hold  /  to go back to the previous folder list.
3. Press and release  or  /  to scroll up or down the list.
  - To select a folder, press and hold , or press  when the folder is highlighted.
  - To go back further in the folder list, press and hold  / .

### Navigating an iPod or USB Device on the Main Audio Screen (Vehicles with a Navigation System)



1. Press and release  or  /  to select the next or previous track within the selected category.
2. Press and hold  or  /  to move quickly through the tracks.
3. Press and release  to move up one track within the selected category.

### Navigating an iPod or USB Device on the Music Navigator Screen (Vehicles with a Navigation System)

1. Press and release  or  /  to select the next or previous track within the selected category.
2. Press and hold  or  /  to move quickly through the tracks within the selected category.

## 5-4 Instruments and Controls

3. Press and release  to move up one track within the selected category.

 /  (**Mute/Push to Talk**): Press to silence the vehicle speakers only. Press again to turn the sound on.

For vehicles with Bluetooth or OnStar systems, press and hold for longer than two seconds to interact with those systems. See *Bluetooth on page 7-49* and *OnStar Overview on page 14-1* for more information.

### SRCE (Source/Voice

**Recognition)**: Press to switch between the radio and CD, and for equipped vehicles, the DVD, front auxiliary, and rear auxiliary.

For vehicles with the navigation system, press and hold this button for longer than one second to initiate voice recognition. See "Voice Recognition" in the Navigation System manual for more information.



 (**Seek**): Press to go to the next radio station while in AM, FM, or SiriusXM®.

For vehicles with or without a navigation system:

Press  to go to the next track or chapter while sourced to the CD or DVD slot.

Press  to select a track or a folder when navigating folders on an iPod or USB device.

For vehicles with a navigation system:

1. Press and hold  until a beep is heard, to place the radio into SCAN mode. A station will play for five seconds before moving to the next station.
2. To stop the SCAN function, press  again.

While listening to a CD/DVD, press and hold  to quickly move forward through the tracks. Release to stop on the desired track.

+  : Press to increase volume.

-  : Press to decrease volume.

### Horn

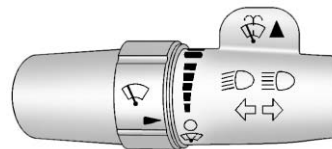

To sound the horn, press the center pad on the steering wheel.

### Windshield Wiper/Washer



The front wiper control is located on the turn and lane-change lever.

The windshield wipers are controlled by turning the band with  on it.

 (**Mist**): For a single wipe, turn to , then release. For several wipes, hold the band on  longer.

 (**Off**): Turns the windshield wipers off.

**! (Adjustable Interval Wipes):**

Turn the band up for more frequent wipes or down for less frequent wipes.

 **(Low Speed):** Slow wipes.

 **(High Speed):** Fast wipes.

Clear ice and snow from the wiper blades before using them. If frozen to the windshield, carefully loosen or thaw them. Damaged wiper blades should be replaced. See *Wiper Blade Replacement on page 10-33*.

Heavy snow or ice can overload the wiper motor. A circuit breaker will stop the motor until it cools down.

**Windshield Washer**** WARNING**

In freezing weather, do not use the washer until the windshield is warmed. Otherwise the washer fluid can form ice on the windshield, blocking your vision.



**(Washer Fluid):** Push the paddle marked with the windshield washer symbol at the top of the multifunction lever, to spray washer fluid on the windshield. The wipers clear the window and then either stop or return to the preset speed.

**Compass**

The vehicle may have a compass in the Driver Information Center (DIC).

**Compass Zone**

The zone is set to zone eight upon leaving the factory. Your dealer will set the correct zone for your location.

Under certain circumstances, such as during a long-distance, cross-country trip or moving to a new state or province, it will be necessary to compensate for compass variance by resetting the zone through the DIC if the zone is not set correctly.

Compass variance is the difference between the earth's magnetic north and true geographic north. If the compass is not set to the zone where you live, the compass may give false readings. The compass must be set to the variance zone in which the vehicle is traveling.

To adjust for compass variance, use the following procedure:

**Compass Variance (Zone) Procedure**

1. Do not set the compass zone when the vehicle is moving. Only set it when the vehicle is in P (Park).

Press the vehicle information button until PRESS ✓ TO CHANGE COMPASS ZONE displays. Or, if the vehicle does not have DIC buttons, press the trip odometer reset stem until CHANGE COMPASS ZONE displays.

## 5-6 Instruments and Controls



2. Find the vehicle's current location and variance zone number on the map.  
Zones 1 through 15 are available.
3. Press the set/reset button to scroll through and select the appropriate variance zone.
4. Press the trip/fuel button until the vehicle heading, for example, N for North, is displayed in the DIC. Or, if the vehicle does not have DIC buttons, press and hold the trip odometer reset stem for

two seconds to select the next available variance zone. Repeat this step until the appropriate variance zone is displayed.

5. If calibration is necessary, calibrate the compass. See "Compass Calibration Procedure" following.

### Compass Calibration

The compass can be manually calibrated. Only calibrate the compass in a magnetically clean and safe location, such as an open parking lot, where driving the vehicle in circles is not a danger. It is suggested to calibrate away from tall buildings, utility wires, manhole covers, or other industrial structures, if possible.

If CAL should ever appear in the DIC display, the compass should be calibrated.

If the DIC display does not show a heading, for example, N for North, or the heading does not change after making turns, there may be a

strong magnetic field interfering with the compass. Such interference may be caused by a magnetic CB or cell phone antenna mount, a magnetic emergency light, magnetic note pad holder, or any other magnetic item. Turn off the vehicle, move the magnetic item, then turn on the vehicle and calibrate the compass.

To calibrate the compass, use the following procedure:

### Compass Calibration Procedure

1. Before calibrating the compass, make sure the compass zone is set to the variance zone in which the vehicle is located. See "Compass Variance (Zone) Procedure" earlier in this section.

Do not operate any switches such as window, sunroof, climate controls, or seats during the calibration procedure.











- Press the vehicle information button until PRESS ✓ TO CALIBRATE COMPASS displays. Or, if the vehicle does not have DIC buttons, press the trip odometer reset stem until CALIBRATE COMPASS displays.
- Press the set/reset button to start the compass calibration. Or, if the vehicle does not have DIC buttons, press and hold the trip odometer reset stem for two seconds to start the compass calibration.
- The DIC will display CALIBRATING: DRIVE IN CIRCLES. Drive the vehicle in tight circles at less than 8 km/h (5 mph) to complete the calibration. The DIC will display CALIBRATION COMPLETE for a few seconds when the calibration is complete. The DIC display will then return to the previous menu.

## Clock

### AM-FM Radio and AM-FM Radio with CD Player





To set the clock:

- Turn the ignition key to ACC/ACCESSORY or ON/RUN, then press the  button to turn the radio on.
- Press the  button until the hour numbers begin to flash, then turn the  knob to increase or decrease the hour.
- Press the  button until the minute numbers begin to flash, then turn the  knob to increase or decrease the minutes.
- Press the  button until the 12HR or 24HR time format begins to flash, then turn the  knob to change the time format.
- Press the  button again until the clock display stops flashing to set the currently displayed





time, or wait until the flashing stops after five seconds and the current time displayed automatically sets.

### MP3 Radios with a Single CD or a Single CD and DVD Player



To adjust the time and date:

- Turn the ignition key to ACC/ACCESSORY or ON/RUN, then press the  button to turn the radio on.
- Press the  button to display HR, MIN, MM, DD, YYYY (hour, minute, month, day, and year).
- Press the softkey located under any one of the tabs to change that setting.
- To increase the time or date, do one of the following:
  - Press the softkey below the selected tab.
  - Press the  SEEK button.
  - Press the  FWD button.

## 5-8 Instruments and Controls





- Turn the  knob clockwise.
5. To decrease the time or date, do one of the following:
- Press the  SEEK button.
  - Press the  REV button.
  - Turn the  knob counterclockwise.

To change the time default setting from 12 hour to 24 hour or to change the date default setting from month/day/year to day/month/year:



1. Press the  button and then the softkey located below the forward arrow tab. 12H, 24H, the date MM/DD (month and day), and DD/MM (day and month) displays.
2. Press the softkey located below the desired option.
3. Press the  button again to apply the desired option, or let the screen time out.

### MP3 Radio with a Six-Disc CD Player

To set the time and date:

1. Turn the ignition key to ACC/ACCESSORY or ON/RUN, then press the  button to turn the radio on.
2. Press the MENU button and then the softkey under the  tab to display HR, MIN, MM, DD, YYYY (hour, minute, month, day, and year).
3. Press the softkey located under any one of the tabs to change that setting.
4. To increase the time or date, do one of the following:
  - Press the softkey below the selected tab.
  - Press the  SEEK button.
  - Press the  FWD button.
  - Turn the  knob clockwise.

5. To decrease the time or date, do one of the following:

- Press the  SEEK button.
- Press the  REV button.
- Turn the  knob counterclockwise.

To change the time default setting from 12 hour to 24 hour or to change the date default setting from month/day to day/month:

1. Press the MENU button and then the softkey under the  tab.
2. Press the softkey located below the forward arrow tab. 12H, 24H, the date MM/DD (month and day), and DD/MM (day and month) displays.
3. Press the softkey located below the desired option.
4. Press the MENU button again to apply the desired option, or let the screen time out.

## Power Outlets

Accessory power outlets can be used to plug in electrical equipment, such as a cell phone, MP3 player, etc.

The vehicle may have two accessory power outlets located below the climate control system, or may have one accessory power outlet and one cigarette lighter. The cigarette lighter is designed to fit only in the receptacle closest to the driver.

There may be another accessory power outlet in the rear cargo area. If the vehicle has a floor console, there is an accessory power outlet inside the storage bin and one on the rear of the floor console.

Remove the cover to access and replace when not in use.

The accessory power outlets are powered, even when the ignition is in LOCK/OFF. Continuing to use

power outlets while the ignition is in LOCK/OFF may cause the vehicle's battery to run down.

### WARNING

Power is always supplied to the outlets. Do not leave electrical equipment plugged in when the vehicle is not in use because the vehicle could catch fire and cause injury or death.

**Notice:** Leaving electrical equipment plugged in for an extended period of time while the vehicle is off will drain the battery. Always unplug electrical equipment when not in use and do not plug in equipment that exceeds the maximum 20 ampere rating.

Certain power accessory plugs may not be compatible to the accessory power outlet and could overload

vehicle or adapter fuses. If a problem is experienced, see your dealer.

When adding electrical equipment, be sure to follow the proper installation instructions included with the equipment. See *Add-On Electrical Equipment* on page 9-101.

**Notice:** Hanging heavy equipment from the power outlet can cause damage not covered by the vehicle warranty. The power outlets are designed for accessory power plugs only, such as cell phone charge cords.

## Cigarette Lighter

To use the cigarette lighter, push it in all the way, and let go. When it is ready for use, the lighter pops back out.

**Notice:** Holding a cigarette lighter in while it is heating does not let the lighter back away from the heating element when it is hot.

Damage from overheating can occur to the lighter or heating element, or a fuse could be blown. Do not hold a cigarette lighter in while it is heating.

### Ashtrays

The vehicle may have a front ashtray located near the center of the instrument panel. Pull on the door to open it. The ashtray may have a cigarette lighter.

**Notice: If papers, pins, or other flammable items are put in the ashtray, hot cigarettes or other smoking materials could ignite them and possibly damage the vehicle. Never put flammable items in the ashtray.**

To remove the ashtray, open the door and pull the ashtray bin toward you. To replace the ashtray, insert the ashtray bin inside the ashtray door and press down until it engages.

### Warning Lights, Gauges, and Indicators

Warning lights and gauges can signal that something is wrong before it becomes serious enough to cause an expensive repair or replacement. Paying attention to the warning lights and gauges could prevent injury.

Warning lights come on when there could be a problem with a vehicle function. Some warning lights come on briefly when the engine is started to indicate they are working.

Gauges can indicate when there could be a problem with a vehicle function. Often gauges and warning lights work together to indicate a problem with the vehicle.

When one of the warning lights comes on and stays on while driving, or when one of the gauges shows there may be a problem, check the section that explains what to do. Follow this manual's advice. Waiting to do repairs can be costly and even dangerous.

## Instrument Cluster

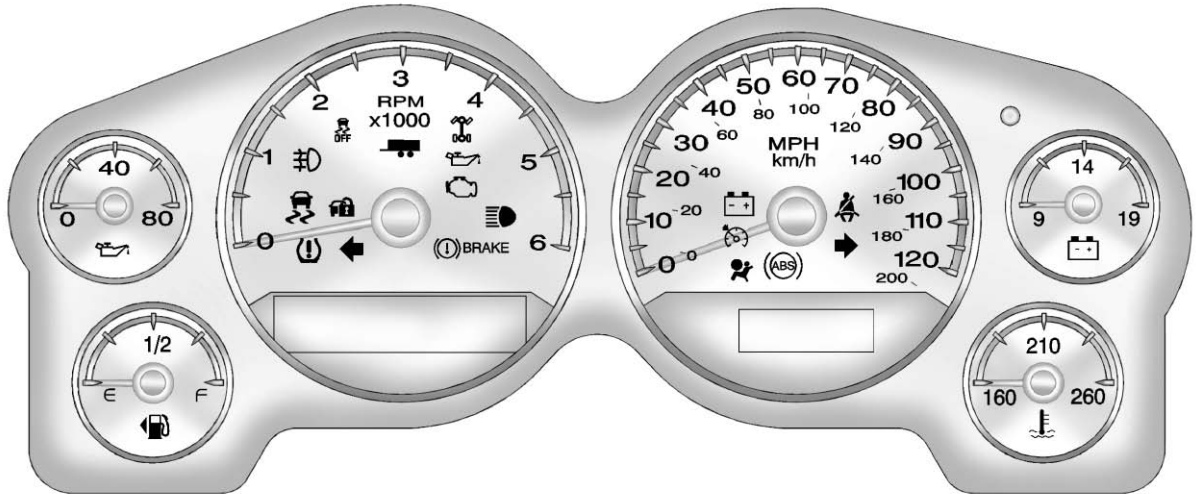

English Light Duty Premium Shown. Metric, Uplevel, Base and Heavy Duty Similar.

## 5-12 Instruments and Controls

---

For vehicles with a DURAMAX<sup>®</sup> Diesel engine, see the DURAMAX<sup>®</sup> Diesel Supplement for more information.

For vehicles with a Hybrid, see the Hybrid Supplement for more information.

### Speedometer

The speedometer shows the vehicle's speed in either kilometers per hour (km/h) or miles per hour (mph).

### Odometer

The odometer shows how far the vehicle has been driven, in either kilometers or miles.

### Engine Hour Meter Display

The Driver Information Center (DIC) can also display the number of hours the engine has run. To display the engine hours, turn the ignition off, then press and hold the reset button for at least four seconds. The hour meter displays for up to 30 seconds, or until the ignition is turned on. See *Driver Information Center (DIC)* on page 5-28 for more information.

### Trip Odometer

The trip odometer shows how far the vehicle has been driven since the trip odometer was last set to zero.

Press the reset button, located on the instrument panel cluster next to the voltmeter, to toggle between the trip odometer and the regular odometer. Holding the reset button for approximately one second while the trip odometer is displayed will reset it.

To display the odometer reading with the ignition off, press the reset button.

See *Driver Information Center (DIC)* on page 5-28 for more information.

### Tachometer

The tachometer displays the engine speed in revolutions per minute (rpm). For a description of how Grade Braking affects vehicle speed while the Tow/Haul Mode is activated, see *Tow/Haul Mode* on page 9-37 for more information.

If the vehicle is a hybrid, see the hybrid supplement for more information.

## Fuel Gauge



Metric

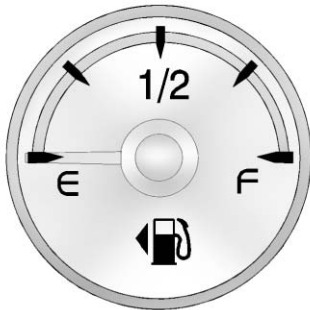

English

When the ignition is on, the fuel gauge shows about how much fuel is left in the fuel tank.

An arrow on the fuel gauge indicates the side of the vehicle the fuel door is on.

The gauge will first indicate empty before the vehicle is out of fuel, but the vehicle's fuel tank should be filled soon.

When the fuel tank is low the FUEL LEVEL LOW message appears. See *Fuel System Messages* on page 5-41 for more information.

Here are some situations owners can experience with the fuel gauge. None of these indicate a problem with the fuel gauge.

- At the gas station, the fuel pump shuts off before the gauge reads full.

- It takes a little more or less fuel to fill up than the fuel gauge indicated. For example, the gauge may have indicated the tank was half full, but it actually took a little more or less than half the fuel tank's capacity to fill it.
- The gauge goes back to empty when the ignition is turned off.

If the vehicle has a diesel engine, see the Duramax diesel supplement for more information.

If the vehicle is a hybrid, see the hybrid supplement for more information.

## Engine Oil Pressure Gauge

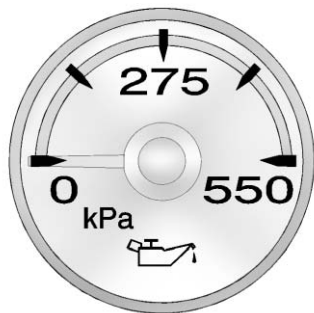

Metric

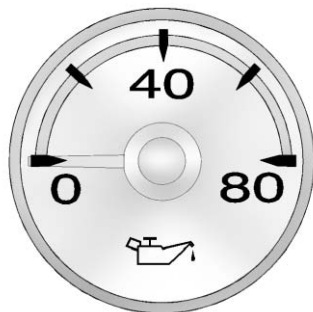

English

The engine oil pressure gauge shows the engine oil pressure in kPa (kilopascals) or psi (pounds per square inch) when the engine is running.

Oil pressure can vary with engine speed, outside temperature and oil viscosity, but if readings are outside the normal operating range, the oil pressure light comes on. See *Engine Oil Pressure Light* on page 5-26 for more information.

A reading outside the normal operating range can be caused by a dangerously low oil level or some other problem causing low oil pressure. Check the vehicle's oil as soon as possible. See "OIL PRESSURE LOW STOP ENGINE" under *Engine Oil Messages* on page 5-40 and *Engine Oil* on page 10-6.

**Notice:** Lack of proper engine oil maintenance can damage the engine. Driving with the engine oil low can also damage the engine. The repairs would not be covered by the vehicle warranty. Check the oil level as soon as possible. Add oil if required, but if the oil level is within the operating range and the oil pressure is still low, have the vehicle serviced. Always follow the maintenance schedule for changing engine oil.



If the vehicle has a diesel engine, see the Duramax diesel supplement for more information.

If the vehicle is a hybrid, see the hybrid supplement for more information.

### Engine Coolant Temperature Gauge

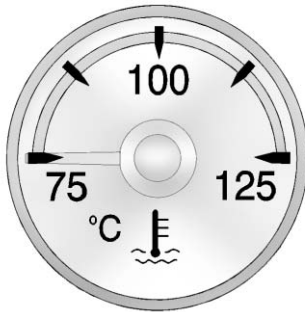

Metric

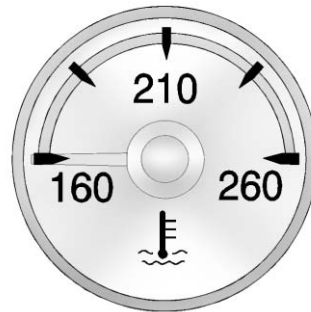

English

This gauge shows the engine coolant temperature.

It also provides an indicator of how hard the vehicle is working. During a majority of the operation, the gauge reads 100°C (210°F) or less.

If pulling a load or going up hills, it is normal for the temperature to fluctuate and go over the 113°C (235°F) mark. If the gauge reaches the 125°C (260°F) mark, it indicates that the cooling system is working beyond its capacity.

See *Engine Overheating* on page 10-20.

If the vehicle is a hybrid, see the hybrid supplement for more information.

### Voltmeter Gauge

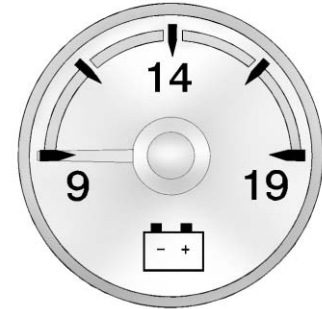

This gauge indicates the battery voltage when the ignition is turned on.

When the ignition is on, this gauge indicates the battery voltage.

## 5-16 Instruments and Controls

---

When the engine is running, this gauge shows the condition of the charging system. The gauge can transition from a higher to lower or a lower to higher reading. This is normal. If the vehicle is operating outside the normal operating range, the charging system light comes on. See *Charging System Light on page 5-20* for more information. The voltmeter gauge may also read lower when in fuel economy mode. This is normal.

Readings outside the normal operating range can also occur when a large number of electrical accessories are operating in the vehicle and the engine is left idling for an extended period. This condition is normal since the charging system is not able to provide full power at engine idle. As engine speeds are increased, this condition should correct itself as higher engine speeds allow the charging system to create maximum power.

The vehicle can only be driven for a short time with the readings outside the normal operating range. If the vehicle must be driven, turn off all accessories, such as the radio and air conditioner.

Readings outside the normal operating range indicate a possible problem in the electrical system. Have the vehicle serviced as soon as possible.

### Safety Belt Reminders

#### Driver Safety Belt Reminder Light

There is a driver safety belt reminder light on the instrument cluster.



When the vehicle is started this light flashes and a chime may come on to remind the driver to fasten their safety belt. Then the light stays on solid until the belt is buckled. This cycle may continue several times if the driver remains or becomes unbuckled while the vehicle is moving.

If the driver safety belt is buckled, neither the light nor the chime comes on.

#### Passenger Safety Belt Reminder Light

There may be a passenger safety belt reminder light near the passenger airbag status indicator. See *Passenger Sensing System on page 3-31*.



For vehicles equipped with the passenger safety belt warning light, when the vehicle is started this light flashes and a chime may come on to remind passengers to fasten their safety belt. Then the light stays on solid until the belt is buckled. This cycle continues several times if the passenger remains or becomes unbuckled while the vehicle is moving.

If the passenger safety belt is buckled, neither the chime nor the light comes on.

The front passenger safety belt warning light and chime may turn on if an object is put on the seat such as a briefcase, handbag, grocery bag, laptop, or other electronic device. To turn off the warning light and/or chime, remove the object from the seat or buckle the safety belt.

## Airbag Readiness Light

This light shows if there is an electrical problem with the airbag system. The system check includes the airbag sensor(s), passenger sensing system (if equipped), the pretensioners, the airbag modules, the wiring, and the crash sensing and diagnostic module. For more information on the airbag system, see *Airbag System on page 3-20*.



The airbag readiness light comes on for several seconds when the vehicle is started. If the light does not come on then, have it fixed immediately.

### WARNING

If the airbag readiness light stays on after the vehicle is started or comes on while driving, it means the airbag system might not be working properly. The airbags in the vehicle might not inflate in a crash, or they could even inflate without a crash. To help avoid injury, have the vehicle serviced right away.

If there is a problem with the airbag system, a Driver Information Center (DIC) message may also come on. See *Airbag System Messages on page 5-43*.

### Airbag On-Off Light

If the vehicle has an airbag on-off switch, it also has a passenger airbag status indicator located in the overhead console.



United States



Canada and Mexico

When the vehicle is started, the passenger airbag status indicator will light ON and OFF, or the symbol

for on and off, will light for several seconds as a system check. Then, after several more seconds, the status indicator ON or OFF, or either the on or off symbol, will light to let you know the status of the right front passenger frontal airbag.

When the right front passenger airbag is manually turned off using the airbag on-off switch in the glove box, the indicator light OFF or the off symbol will come on and stay on as a reminder that the airbag has been turned off. This light will go off when the airbag has been turned on. See *Airbag On-Off Switch* on page 3-28 for more information, including important safety information.

PASSENGER 

AIR BAG OFF

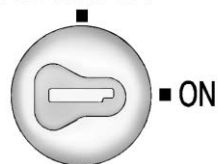

United States

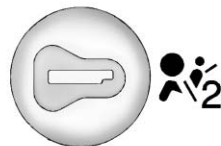

Canada and Mexico

**⚠ WARNING**

If the right front passenger airbag is turned off for a person who is not in a risk group identified by the national government, that person will not have the extra protection of an airbag. In a crash, the airbag will not be able to inflate and help protect the person sitting there.

Do not turn off the passenger airbag unless the person sitting there is in a risk group identified by the national government. See *Airbag On-Off Switch on page 3-28* for more on this, including important safety information.

**⚠ WARNING**

If the airbag readiness light ever comes on and stays on, it means that something may be wrong with the airbag system. For example, the right front passenger airbag could inflate even though the airbag on-off switch is turned off.

To help avoid injury to yourself or others, have the vehicle serviced right away. See *Airbag Readiness Light on page 5-17* for more information, including important safety information.

If the word ON or the on symbol is lit, it means that the right front passenger frontal airbag is enabled (may inflate). See *Airbag On-Off Switch on page 3-28* for more information, including important safety information.

If, after several seconds, both status indicator lights remain on, or if there are no lights at all, there may be a problem with the lights or the airbag on-off switch. See your dealer for service.

**Passenger Airbag Status Indicator**

If the vehicle has one of the indicators pictured in the following illustrations, then the vehicle has a passenger sensing system for the right front passenger position unless there is an airbag off switch located in the glove box. If there is an airbag off switch, the vehicle does not have a passenger sensing system. See *Airbag On-Off Switch on page 3-28*.

The passenger airbag status indicator is on the overhead console. See *Passenger Sensing System on page 3-31* for important safety information.

## 5-20 Instruments and Controls

In addition, if the vehicle has a passenger sensing system for the right front passenger position, the label on the vehicle's sun visor refers to "ADVANCED AIRBAGS".



United States



Canada and Mexico

When the vehicle is started, the passenger airbag status indicator will light ON and OFF, or the symbol for on and off, for several seconds as a system check. Then, after several more seconds, the status indicator will light either ON or OFF,

or either the on or off symbol to let you know the status of the right front passenger frontal airbag.

If the word ON or the on symbol is lit on the passenger airbag status indicator, it means that the right front passenger frontal airbag is enabled (may inflate).

If the word OFF or the off symbol is lit on the airbag status indicator, it means that the passenger sensing system has turned off the right front passenger frontal airbag.

If, after several seconds, both status indicator lights remain on, or if there are no lights at all, there may be a problem with the lights or the passenger sensing system. See your dealer for service.

### **WARNING**

If the airbag readiness light ever comes on and stays on, it means that something may be wrong

(Continued)

### **WARNING (Continued)**

with the airbag system. To help avoid injury to yourself or others, have the vehicle serviced right away. See *Airbag Readiness Light* on page 5-17 for more information, including important safety information.

## Charging System Light

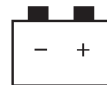

This light comes on briefly when the ignition key is turned to START, but the engine is not running, as a check to show it is working.

If it does not, have the vehicle serviced by your dealer.

The light should go out once the engine starts. If it stays on, or comes on while driving, there could be a problem with the charging system. A charging system message in the Driver Information Center (DIC) can also appear. See *Battery Voltage and Charging Messages on page 5-37* for more information. This light could indicate that there are problems with a generator drive belt, or that there is an electrical problem. Have it checked right away. If the vehicle must be driven a short distance with the light on, turn off accessories, such as the radio and air conditioner.

If the vehicle is a hybrid, see the hybrid supplement for more information.

## Malfunction Indicator Lamp

A computer system called OBD II (On-Board Diagnostics-Second Generation) monitors the operation of the vehicle to ensure emissions are at acceptable levels, helping to maintain a clean environment. The malfunction indicator lamp comes on when the vehicle is placed in ON/RUN, as a check to show it is working. If it does not, have the vehicle serviced by your dealer. See *Ignition Positions on page 9-24*.



If the malfunction indicator lamp comes on while the engine is running, this indicates that the OBD II system has detected a problem and diagnosis and service might be required.

Malfunctions often are indicated by the system before any problem is apparent. Being aware of the light can prevent more serious damage to the vehicle. This system also assists the service technician in correctly diagnosing any malfunction.

**Notice:** If the vehicle is continually driven with this light on, the emission controls might not work as well, the vehicle fuel economy might not be as good, and the engine might not run as smoothly. This could lead to costly repairs that might not be covered by the vehicle warranty.

**Notice:** Modifications made to the engine, transmission, exhaust, intake, or fuel system of the vehicle or the replacement of the original tires with other than those of the same Tire Performance Criteria (TPC) can affect the vehicle's emission controls and can cause this light to come on. Modifications to these systems could lead to

## 5-22 Instruments and Controls

---

**costly repairs not covered by the vehicle warranty. This could also result in a failure to pass a required Emission Inspection/Maintenance test. See *Accessories and Modifications on page 10-3.***

This light comes on during a malfunction in one of two ways:

**Light Flashing:** A misfire condition has been detected. A misfire increases vehicle emissions and could damage the emission control system on the vehicle. Diagnosis and service might be required.

To prevent more serious damage to the vehicle:

- Reduce vehicle speed.
- Avoid hard accelerations.
- Avoid steep uphill grades.
- If towing a trailer, reduce the amount of cargo being hauled as soon as it is possible.

If the light continues to flash, find a safe place to stop and park the vehicle. Turn the vehicle off, wait at least 10 seconds, and restart the engine. If the light is still flashing, follow the previous steps and see your dealer for service as soon as possible.

**Light On Steady:** An emission control system malfunction has been detected on the vehicle. Diagnosis and service might be required.

The following may correct an emission control system malfunction:

- Check that the fuel cap is fully installed. See *Filling the Tank on page 9-68.* The diagnostic system can determine if the fuel cap has been left off or improperly installed. A loose or missing fuel cap allows fuel to evaporate into the atmosphere. A few driving trips with the cap properly installed should turn the light off.

- Check that good quality fuel is used. Poor fuel quality causes the engine not to run as efficiently as designed and may cause stalling after start-up, stalling when the vehicle is changed into gear, misfiring, hesitation on acceleration, or stumbling on acceleration. These conditions might go away once the engine is warmed up.

If one or more of these conditions occurs, change the fuel brand used. It may require at least one full tank of the proper fuel to turn the light off.

See *Recommended Fuel on page 9-66.*

If none of the above have made the light turn off, your dealer can check the vehicle. The dealer has the proper test equipment and diagnostic tools to fix any mechanical or electrical problems that might have developed.



## Emissions Inspection and Maintenance Programs

Depending on where you live, your vehicle may be required to participate in an emission control system inspection and maintenance program. For the inspection, the emission system test equipment will likely connect to the vehicle's Data Link Connector (DLC).

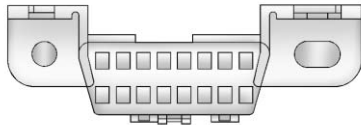

The DLC is under the instrument panel to the left of the steering wheel. See your dealer if assistance is needed.

The vehicle may not pass inspection if:

- The malfunction indicator lamp is on with the engine running, or if the light does not come on when

the ignition is turned to ON/RUN while the engine is off. See your dealer for assistance in verifying proper operation of the malfunction indicator lamp.

- The OBD II (On-Board Diagnostics) system determines that critical emission control systems have not been completely diagnosed. The vehicle would be considered not ready for inspection. This can happen if the 12-volt battery has recently been replaced or run down. The diagnostic system is designed to evaluate critical emission control systems during normal driving. This can take several days of routine driving. If this has been done and the vehicle still does not pass the inspection for lack of OBD II system readiness, your dealer can prepare the vehicle for inspection.

## Brake System Warning Light

With the ignition on, the brake system warning light comes on when the parking brake is set. If the vehicle is driven with the parking brake engaged, a chime sounds when the vehicle speed is greater than 8 km/h (5 mph).

The vehicle brake system consists of two hydraulic circuits. If one circuit is not working, the remaining circuit can still work to stop the vehicle. For normal braking performance, both circuits need to be working.

If the warning light comes on and a chime sounds there could be a brake problem. Have the brake system inspected right away.

This light can also come on due to low brake fluid. See *Brake Fluid* on page 10-25 for more information.



Metric



English

BRAKE

This light comes on briefly when the ignition key is turned to ON/RUN. If it does not come on then, have it fixed so it is ready to warn if there is a problem.

### WARNING

The brake system might not be working properly if the brake system warning light is on. Driving with the brake system warning light on can lead to a crash. If the light is still on after the vehicle has been pulled off the road and carefully stopped, have the vehicle towed for service.

If the light comes on while driving, pull off the road and stop carefully. The pedal might be harder to push or might go closer to the floor. It can take longer to stop. If the light is still on, have the vehicle towed for service. See *Towing the Vehicle on page 10-87*.

If the vehicle is a hybrid, see the hybrid supplement for more information.

### Antilock Brake System (ABS) Warning Light



For vehicles with the Antilock Brake System (ABS), this light comes on briefly when the engine is started.

If it does not, have the vehicle serviced by your dealer. If the system is working normally the indicator light then goes off.

If the ABS light stays on, turn the ignition off. If the light comes on while driving, stop as soon as it is safely possible and turn the ignition off. Then start the engine again to reset the system. If the ABS light stays on, or comes on again while driving, the vehicle needs service. If the regular brake system warning light is not on, the vehicle still has brakes, but not antilock brakes. If the regular brake system warning light is also on, the vehicle does not have antilock brakes and there is a problem with the regular brakes. See *Brake System Warning Light on page 5-23*.

For vehicles with a Driver Information Center (DIC), see *Brake System Messages on page 5-38* for all brake-related DIC messages.

If the vehicle is a hybrid, see the hybrid supplement for more information.

## Four-Wheel-Drive Light



For vehicles equipped with the four-wheel-drive light, it comes on when a vehicle with a manual transfer case is shifted into four-wheel drive and the front axle engages.

Some delay between the shifting and the light coming on is normal.

See *Four-Wheel Drive* on page 9-38 for more information.

## Tow/Haul Mode Light



For vehicles with the Tow/Haul Mode feature, this light comes on when the Tow/Haul Mode has been activated.

For more information, see *Tow/Haul Mode* on page 9-37.

## StabiliTrak® OFF Light



This light comes on briefly while starting the engine.

If it does not, have the vehicle serviced by your dealer. If the system is working normally, the indicator light then goes off.

Press and release the Traction Control System (TCS)/StabiliTrak button to turn off TCS, and a message displays in the DIC.

Press and briefly hold the TCS/StabiliTrak button to turn off the StabiliTrak system; the StabiliTrak Off light comes on and a message appears in the Driver Information Center (DIC).

If the StabiliTrak/TCS system is off, the system does not assist in controlling the vehicle. Turn on the StabiliTrak/TCS system and the indicator light turns off.

See *StabiliTrak® System* on page 9-53, and *Ride Control System Messages* on page 5-42 for more information.

## Traction Control System (TCS)/StabiliTrak® Light



The TCS/StabiliTrak light comes on briefly when the engine is started.

If the light does not come on or stays on, have the vehicle serviced by the dealer. If the system is working normally, the indicator light turns off.

If the light comes on and stays on while driving, and a message displays in the Driver Information Center (DIC), have the vehicle serviced by the dealer. See *Ride Control System Messages on page 5-42* for more information.

If the light flashes while driving, this means that StabiliTrak or TCS is assisting in controlling the vehicle. See *StabiliTrak® System on page 9-53* for more information.

## Tire Pressure Light



For vehicles with the Tire Pressure Monitor System (TPMS), this light comes on briefly when the engine is started. It provides information about tire pressures and the TPMS.

### When the Light Is On Steady

This indicates that one or more of the tires are significantly underinflated.

A Driver Information Center (DIC) tire pressure message may also display. See *Tire Messages on page 5-43*. Stop as soon as

possible, and inflate the tires to the pressure value shown on the Tire and Loading Information label. See *Tire Pressure on page 10-55*.

### When the Light Flashes First and Then Is On Steady

If the light flashes for about a minute and then stays on, there may be a problem with the TPMS. If the problem is not corrected, the light will come on at every ignition cycle. See *Tire Pressure Monitor Operation on page 10-58*.

## Engine Oil Pressure Light



**Notice:** Lack of proper engine oil maintenance can damage the engine. Driving with the engine oil low can also damage the engine. The repairs would not be

covered by the vehicle warranty. Check the oil level as soon as possible. Add oil if required, but if the oil level is within the operating range and the oil pressure is still low, have the vehicle serviced. Always follow the maintenance schedule for changing engine oil.

This light comes on briefly while starting the engine. If it does not, have the vehicle serviced by your dealer. If the system is working normally the indicator light then goes off.

If the light comes on and stays on, it means that oil is not flowing through the engine properly. The vehicle could be low on oil and it might have some other system problem.

If the vehicle is a hybrid, see the hybrid supplement for more information.

## Low Fuel Warning Light



This light, under the fuel gauge, comes on briefly while the engine is being started.

This light and a chime, if the vehicle is equipped with a radio, comes on when the fuel tank is low on fuel.

The Driver Information Center also displays a FUEL LEVEL LOW message. See *Fuel System Messages* on page 5-41 for more information. When fuel is added this light and message should go off. If it does not, have the vehicle serviced by your dealer.

## Security Light



The security light should come on briefly as the engine is started. If the system is working normally, the indicator light turns off. If it does not come on, have the vehicle serviced by your dealer.

If the light stays on and the engine does not start, there could be a problem with the theft-deterrent system.

This light is also used to indicate the status of the anti-theft alarm system when the ignition is turned off. The light will flash rapidly if the alarm system is arming and one or more of the monitored entry points is not closed. The light will stay on if the alarm is arming and all entry points are closed.

For information regarding this light and the vehicle's security system, see *Vehicle Alarm System* on page 2-10.

### High-Beam On Light



This light comes on when the high-beam headlamps are in use.

See *Headlamp High/Low-Beam Changer* on page 6-2.

### Front Fog Lamp Light



For vehicles with fog lamps, this light comes on when the fog lamps are on.

The light goes out when the fog lamps are turned off. See *Fog Lamps* on page 6-6 for more information.

### Cruise Control Light



For vehicles equipped with cruise control, this light comes on whenever the cruise control is set.

The light goes out when the cruise control is turned off. See *Cruise Control* on page 9-56 for more information.

## Information Displays

### Driver Information Center (DIC)

The vehicle has a Driver Information Center (DIC).

The DIC displays information about this vehicle. It also displays warning messages if a system problem is detected.

All messages will appear in the DIC display located below the tachometer in the instrument panel cluster.

The DIC comes on when the ignition is on. After a short delay, the DIC will display the information that was last displayed before the engine was turned off.

The DIC has different displays which can be accessed by pressing the DIC buttons located on the instrument panel, next to the steering wheel. If the vehicle does not have DIC buttons, the trip odometer reset stem can be used to access some of the menu items.

The DIC displays trip, fuel, and vehicle system information, and warning messages if a system problem is detected.

The DIC also allows some features to be customized. See *Vehicle Personalization (With DIC Buttons)* on page 5-46 for more information.

If the vehicle has a diesel engine, see the Duramax<sup>®</sup> diesel supplement for more information.

## DIC Buttons



The buttons are the trip/fuel, vehicle information, customization, and set/reset buttons. The button functions are detailed in the following pages.

**Wiper icon (Trip/Fuel):** Press this button to display the odometer, trip odometer, fuel range, average economy, fuel used, timer, transmission temperature, and instantaneous economy and Active Fuel Management™ indicator. The compass and outside temperature will also be shown in the display.

The temperature will be shown in °C or °F depending on the units selected.

**Car icon (Vehicle Information):** Press this button to display the oil life, units, tire pressure readings for vehicles with the Tire Pressure Monitor System (TPMS), trailer brake gain and output information for vehicles with the Integrated Trailer Brake Control (ITBC) system, engine hours, compass zone setting, and compass recalibration.

**Checkmark and box icon (Customization):** Press this button to customize the feature settings on the vehicle. See *Vehicle Personalization (With DIC Buttons)* on page 5-46 for more information.

**Box and checkmark icon (Set/Reset):** Press this button to set or reset certain functions and to turn off or acknowledge messages on the DIC.

### Trip/Fuel Menu Items (with DIC Buttons)

 (Trip/Fuel): Press this button to scroll through the following menu items:

#### Odometer

Press the trip/fuel button until ODOMETER displays. This display shows the distance the vehicle has been driven in either kilometers (km) or miles. Pressing the trip odometer reset stem will also display the odometer.

To switch between metric and English measurements, see “Units” later in this section.

#### Trip Odometer

Press the trip/fuel button until TRIP displays. This display shows the current distance traveled in either kilometers (km) or miles since the last reset for the trip odometer. Pressing the trip odometer reset stem will also display the trip odometer.

The trip odometer can be reset to zero by pressing the set/reset button while the trip odometer is displayed. You can also reset the trip odometer while it is displayed by pressing and holding the trip odometer reset stem.

The trip odometer has a feature called the retro-active reset. This can be used to set the trip odometer to the number of miles (kilometers) driven since the ignition was last turned on. This can be used if the trip odometer is not reset at the beginning of the trip.

To use the retro-active reset feature, press and hold the set/reset button for at least four seconds. The trip odometer will display the number of kilometers (km) or miles driven since the ignition was last turned on and the vehicle was moving. Once the vehicle begins moving, the trip odometer will accumulate mileage. For example, if the vehicle was driven 8 km (5 miles) before it is started again, and then the retro-active reset feature is

activated, the display will show 8 km (5 miles). As the vehicle begins moving, the display will then increase to 8.2 km (5.1 miles), 8.4 km (5.2 miles), etc.

#### Fuel Range

Press the trip/fuel button until FUEL RANGE displays. This display shows the approximate number of remaining kilometers (km) or miles the vehicle can be driven without refueling. The display will show LOW if the fuel level is low.

The fuel range estimate is based on an average of the vehicle's fuel economy over recent driving history and the amount of fuel remaining in the fuel tank. This estimate will change if driving conditions change. For example, if driving in traffic and making frequent stops, this display may read one number, but if the vehicle is driven on a freeway, the number may change even though the same amount of fuel is in the fuel tank. This is because different driving conditions produce different



fuel economies. Generally, freeway driving produces better fuel economy than city driving. Fuel range cannot be reset.

**Average Economy**

Press the trip/fuel button until AVG ECONOMY displays. This display shows the approximate average liters per 100 kilometers (L/100 km) or miles per gallon (mpg). This number is calculated based on the number of L/100 km (mpg) recorded since the last time this menu item was reset. To reset AVG ECONOMY, press and hold the set/reset button.

**Fuel Used**

Press the trip/fuel button until FUEL USED displays. This display shows the number of liters (L) or gallons (gal) of fuel used since the last reset of this menu item. To reset the fuel used information, press and hold the set/reset button while FUEL USED is displayed.

**Speedometer**

The speedometer shows how fast the vehicle is moving in either kilometers per hour (km/h) or miles per hour (mph). The speedometer cannot be reset.

**Timer**

Press the trip/fuel button until TIMER displays. This display can be used as a timer.

To start the timer, press the set/reset button while TIMER is displayed. The display will show the amount of time that has passed since the timer was last reset, not including time the ignition is off. Time will continue to be counted as long as the ignition is on, even if another display is being shown on the DIC. The timer will record up to 99 hours, 59 minutes, and 59 seconds (99:59:59) after which the display will return to zero.

To stop the timer, press the set/reset button briefly while TIMER is displayed.

To reset the timer to zero, press and hold the set/reset button while TIMER is displayed.

**Transmission Temperature**

Press the trip/fuel button until TRANS TEMP displays. This display shows the temperature of the automatic transmission fluid in either degrees Celsius (°C) or degrees Fahrenheit (°F).

**Instantaneous Economy and Active Fuel Management™ Indicator**

If the vehicle has this display, press the trip/fuel button until INST ECON V8 displays. This display shows the current fuel economy at a particular moment and will change frequently as driving conditions change. This display shows the instantaneous fuel economy in liters per 100 kilometers (L/100 km) or miles per gallon (mpg). Unlike average economy, this screen cannot be reset.

## 5-32 Instruments and Controls

---

An Active Fuel Management indicator displays on the right side of the DIC, while INST ECON displays on the left side. Active Fuel Management allows the engine to operate on either four or eight cylinders, depending on driving demands. When Active Fuel Management is active, V4 will display on the DIC. When Active Fuel Management is inactive, V8 will display. See *Active Fuel Management*® on page 9-30 for more information.

### Blank Display

This display shows no information.

### Vehicle Information Menu Items (with DIC Buttons)

 (Vehicle Information): Press this button to scroll through the following menu items:

#### Oil Life

Press the vehicle information button until OIL LIFE REMAINING displays. This display shows an

estimate of the oil's remaining useful life. If you see 99% OIL LIFE REMAINING on the display, that means 99% of the current oil life remains. The engine oil life system will alert you to change the oil on a schedule consistent with your driving conditions.

When the remaining oil life is low, the CHANGE ENGINE OIL SOON message will appear on the display. See "CHANGE ENGINE OIL SOON" under *Engine Oil Messages* on page 5-40. You should change the oil as soon as you can. See *Engine Oil* on page 10-6. In addition to the engine oil life system monitoring the oil life, additional maintenance is recommended in the Maintenance Schedule in this manual. See *Maintenance Schedule* on page 11-3 for more information.

Remember, you must reset the OIL LIFE display after each oil change. It will not reset itself. Also, be careful not to reset the OIL LIFE display accidentally at any time other than when the oil has just

been changed. It cannot be reset accurately until the next oil change. To reset the engine oil life system, see *Engine Oil Life System* on page 10-9.

### Units

Press the vehicle information button until UNITS displays. This display allows you to select between metric or English units of measurement. Once in this display, press the set/reset button to select between METRIC or ENGLISH units. All of the vehicle information will then be displayed in the unit of measurement selected.

### Tire Pressure

If the vehicle has the Tire Pressure Monitor System (TPMS), the pressure for each tire can be viewed in the DIC. The tire pressure will be shown in either kilopascals (kPa) or pounds per square inch (psi). Press the vehicle information button until the DIC displays FRONT TIRES kPa (PSI) LEFT ## RIGHT ##. Press the vehicle

information button again until the DIC displays REAR TIRES kPa (PSI) LEFT ## RIGHT ##.

If a low tire pressure condition is detected by the system while driving, a message advising you to add pressure in a specific tire will appear in the display. See *Tire Pressure on page 10-55* and *Tire Messages on page 5-43* for more information.

If the tire pressure display shows dashes instead of a value, there may be a problem with the vehicle. If this consistently occurs, see your dealer for service.

### **Trailer Gain and Output**

On vehicles with the Integrated Trailer Brake Control (ITBC) system, the trailer brake display appears in the DIC. Press the vehicle information button until TRAILER GAIN and OUTPUT display.

TRAILER GAIN shows the trailer gain setting. This setting can be adjusted from 0.0 to 10.0 with either a trailer connected or disconnected.

OUTPUT shows the power output to the trailer any time a trailer with electric brakes is connected. Output is displayed in 0 to 10 bars. Dashes may appear in the OUTPUT display.

To adjust trailer gain see “Integrated Trailer Brake Control System” under *Towing Equipment on page 9-89* for more information.

### **Battery**

This display shows the current battery voltage. If the voltage is in the normal range, the value will display. For example, the display may read BATTERY 13 VOLTS. Your vehicle’s charging system regulates voltage based on the state of the battery. The battery voltage may fluctuate when viewing this information on the DIC. This is normal.

### **Oil Pressure**

This display shows the oil pressure in either kilopascals (kPa) or pounds per square inch (psi).

### **Engine Hours**

Press the vehicle information button until ENGINE HOURS displays. This display shows the total number of hours the engine has run.

### **Compass Zone Setting**

This display allows for setting the compass zone. See *Compass on page 5-5* for more information.

### **Compass Recalibration**

This display allows for calibrating the compass. See *Compass on page 5-5* for more information.

### **Blank Display**

This display shows no information.

### **Trip Odometer Reset Stem Menu Items (with DIC Buttons)**

Use the trip odometer reset stem to view the odometer and trip odometer. The Language selection and Engine Hours display can also be accessed with the trip odometer reset stem.

#### **Odometer**

Press the trip odometer reset stem until ODOMETER displays. This display shows the distance the vehicle has been driven in either kilometers (km) or miles (mi).

#### **Trip Odometer**

Press the trip odometer reset stem until TRIP displays. This display shows the current distance traveled in either kilometers (km) or miles (mi) since the last reset for the trip odometer.

The trip odometer can be reset to zero by pressing and holding the trip odometer reset stem while the trip odometer is displayed.

The trip odometer has a feature called the retro-active reset. This can be used to set the trip odometer to the number of miles (kilometers) driven since the ignition was last turned on. This can be used if the trip odometer is not reset at the beginning of the trip.

To use the retro-active reset feature, press and hold the trip odometer reset stem for at least four seconds. The trip odometer will display the number of kilometers (km) or miles (mi) driven since the ignition was last turned on and the vehicle was moving. Once the vehicle begins moving, the trip odometer will accumulate mileage. For example, if the vehicle was driven 8 km (5 miles) before it is started again, and then the retro-active reset feature is activated, the display will show 8 km (5 miles). As the vehicle begins moving, the display will then increase to 8.2 km (5.1 miles), 8.4 km (5.2 miles), etc.

### **Language**

This display allows you to select the language in which the DIC messages will appear. To select a language:

1. Press the trip odometer reset stem until ODOMETER displays.
2. While in the ODOMETER display, press and hold the trip odometer reset stem for three seconds until the currently set language displays.
3. Continue to press and hold the trip odometer reset stem to scroll through all of the available languages.

The available selections are ENGLISH (default), FRANCAIS (French), ESPANOL (Spanish), and NO CHANGE.

4. Once the desired language is displayed, release the trip odometer reset stem to set the choice.

## Engine Hours

To display the ENGINE HOURS, place the ignition in LOCK/OFF or ACC/ACCESSORY, then press and hold the trip odometer reset stem for four seconds while viewing the ODOMETER. This display shows the total number of hours the engine has run.

## Trip Odometer Reset Stem Menu Items (without DIC Buttons)

### Language

This display allows you to select the language in which the DIC messages will appear. To select a language:

1. Press the trip odometer reset stem until ODOMETER displays.
2. While in the ODOMETER display, press and hold the trip odometer reset stem for three seconds until the currently set language displays.

3. Continue to press and hold the trip odometer reset stem to scroll through all of the available languages.

The available languages are ENGLISH (default), FRANCAIS (French), ESPANOL (Spanish), and NO CHANGE.

4. Once the desired language is displayed, release the trip odometer reset stem to set the choice.

### Trip Odometer

Press the trip odometer reset stem until TRIP displays. This display shows the current distance traveled in either kilometers (km) or miles (mi) since the last reset for the trip odometer.

The trip odometer can be reset to zero by pressing and holding the trip odometer reset stem while the trip odometer is displayed.

The trip odometer has a feature called the retro-active reset. This can be used to set the trip odometer to the number of miles (kilometers) driven since the ignition was last turned on. This can be used if the trip odometer is not reset at the beginning of the trip.

To use the retro-active reset feature, press and hold the trip odometer reset stem for at least four seconds. The trip odometer will display the number of kilometers (km) or miles (mi) driven since the ignition was last turned on and the vehicle was moving. Once the vehicle begins moving, the trip odometer will accumulate mileage. For example, if the vehicle was driven 8 km (5 miles) before it is started again, and then the retro-active reset feature is activated, the display will show 8 km (5 miles). As the vehicle begins moving, the display will then increase to 8.2 km (5.1 miles), 8.4 km (5.2 miles), etc.

### Transmission Temperature

Press the trip odometer reset stem until TRANS TEMP displays. This display shows the temperature of the automatic transmission fluid in either degrees Celsius (°C) or degrees Fahrenheit (°F).

### Trailer Gain and Output

On vehicles with the Integrated Trailer Brake Control (ITBC) system, the trailer brake display appears in the DIC. Press the trip odometer reset stem until TRAILER GAIN and OUTPUT display.

TRAILER GAIN shows the trailer gain setting. This setting can be adjusted from 0.0 to 10.0 with either a trailer connected or disconnected.

OUTPUT shows the power output to the trailer any time a trailer with electric brakes is connected. Output is displayed in 0 to 10 bars. Dashes may appear in the OUTPUT display.

To adjust trailer gain see “Integrated Trailer Brake Control System” under *Towing Equipment on page 9-89* for more information.

### Speedometer

The speedometer shows how fast the vehicle is moving in either kilometers per hour (km/h) or miles per hour (mph). The speedometer cannot be reset.

### Battery

This display shows the current battery voltage. If the voltage is in the normal range, the value will display. For example, the display may read BATTERY 13 VOLTS. Your vehicle’s charging system regulates voltage based on the state of the battery. The battery voltage may fluctuate when viewing this information on the DIC. This is normal.

### Oil Pressure

This display shows the oil pressure in either kilopascals (kPa) or pounds per square inch (psi).

### Compass Zone Setting

This display allows for setting the compass zone. See *Compass on page 5-5* for more information.

### Compass Recalibration

This display allows for calibrating the compass. See *Compass on page 5-5* for more information.

### Oil Life

To access this display, the vehicle must be in P (Park). Press the trip odometer reset stem until OIL LIFE REMAINING displays. This display shows an estimate of the oil’s remaining useful life. If you see 99% OIL LIFE REMAINING on the display, that means 99% of the current oil life remains. The engine oil life system will alert you to change the oil on a schedule consistent with your driving conditions.

When the remaining oil life is low, the CHANGE ENGINE OIL SOON message will appear on the display. See "CHANGE ENGINE OIL SOON" under *Engine Oil Messages on page 5-40*. You should change the oil as soon as you can. See *Engine Oil on page 10-6*. In addition to the engine oil life system monitoring the oil life, additional maintenance is recommended in the Maintenance Schedule in this manual. See *Maintenance Schedule on page 11-3* for more information.

Remember, you must reset the OIL LIFE display after each oil change. It will not reset itself. Also, be careful not to reset the OIL LIFE display accidentally at any time other than when the oil has just been changed. It cannot be reset accurately until the next oil change. To reset the engine oil life system, see *Engine Oil Life System on page 10-9*.

## Vehicle Messages

Messages displayed on the DIC indicate the status of the vehicle or some action may be needed to correct a condition. Multiple messages may appear one after another.

The messages that do not require immediate action can be acknowledged and cleared by pressing ✓ (Set/Reset) or the trip odometer reset stem.

The messages that require immediate action cannot be cleared until that action is performed.

All messages should be taken seriously and clearing the message does not correct the problem.

The following are the possible messages and some information about them.

If the vehicle has a diesel engine, see the Duramax<sup>®</sup> diesel supplement for more information.

## Battery Voltage and Charging Messages

### BATTERY LOW START VEHICLE

When the vehicle's battery is severely discharged, this message will display and four chimes will sound. Start the vehicle immediately. If the vehicle is not started and the battery continues to discharge, the climate controls, heated seats, and audio systems will shut off and the vehicle may require a jump start. These systems will function again after the vehicle is started.

### SERVICE BATTERY CHARGING SYSTEM

On some vehicles, this message displays if there is a problem with the battery charging system. Under certain conditions, the charging system light may also turn on in the instrument panel cluster. See *Charging System Light on page 5-20*. Driving with this problem

could drain the battery. Turn off all unnecessary accessories. Have the electrical system checked as soon as possible. See your dealer.

### Brake System Messages

#### SERVICE BRAKE SYSTEM

This message displays along with the brake system warning light if there is a problem with the brake system. See *Brake System Warning Light* on page 5-23. If this message appears, stop as soon as possible and turn off the vehicle. Restart the vehicle and check for the message on the DIC display. If the message is still displayed or appears again when you begin driving, the brake system needs service as soon as possible. See your dealer.

#### SERVICE BRAKES SOON

On some vehicles, this message displays if there is a problem with the brake system. If this message appears, stop as soon as possible and turn off the vehicle. Restart the

vehicle and check for the message on the DIC display. If the message is still displayed or appears again when you begin driving, the brake system needs service. See your dealer.

#### SERVICE TRAILER BRAKE SYSTEM

On vehicles with the Integrated Trailer Brake Control (ITBC) system, this message displays and a chime may sound when there is a problem with the ITBC system.

When this message displays, power is no longer available to the trailer brakes.

As soon as it is safe to do so, carefully pull your vehicle over to the side of the road and turn the ignition off. Check the wiring connection to the trailer and turn the ignition back on. If this message still displays, either your vehicle or the trailer needs service. See your dealer.

See “Integrated Trailer Brake Control System” under *Towing Equipment* on page 9-89 for more information.

### Door Ajar Messages

#### DRIVER DOOR OPEN

This message displays and a chime may sound if the driver door is not fully closed and the vehicle is shifted out of P (Park). Stop and turn off the vehicle, check the door for obstructions, and close the door again. Check to see if the message still appears on the DIC.

#### HOOD OPEN

This message displays and a chime may sound if the hood is not fully closed. Stop and turn off the vehicle, check the hood for obstructions, and close the hood again. Check to see if the message still appears on the DIC.



### LEFT REAR DOOR OPEN (Crew Cab)

This message displays and a chime may sound if the driver side rear door is not fully closed and the vehicle is shifted out of P (Park). Stop and turn off the vehicle, check the door for obstructions, and close the door again. Check to see if the message still appears on the DIC.

### PASSENGER DOOR OPEN

This message displays and a chime may sound if the front passenger door is not fully closed and the vehicle is shifted out of P (Park). Stop and turn off the vehicle, check the door for obstructions, and close the door again. Check to see if the message still appears on the DIC.

### RIGHT REAR DOOR OPEN (Crew Cab)

This message displays and a chime may sound if the passenger side rear door is not fully closed and the vehicle is shifted out of P (Park).

Stop and turn off the vehicle, check the door for obstructions, and close the door again. Check to see if the message still appears on the DIC.

## Engine Cooling System Messages

**Notice:** If you drive the vehicle while the engine is overheating, severe engine damage may occur. If an overheat warning appears on the instrument cluster and/or DIC, stop the vehicle as soon as possible. See *Engine Overheating on page 10-20*.

### ENGINE HOT A/C (Air Conditioning) TURNED OFF

This message displays when the engine coolant becomes hotter than the normal operating temperature. See *Engine Coolant Temperature Gauge on page 5-15*. To avoid added strain on a hot engine, the air conditioning compressor automatically turns off. When the coolant temperature returns to

normal, the air conditioning compressor turns back on. You can continue to drive your vehicle.

If this message continues to appear, have the system repaired by your dealer as soon as possible to avoid damage to the engine.

### ENGINE OVERHEATED IDLE ENGINE

This message displays when the engine coolant temperature is too hot. Stop and allow the vehicle to idle until it cools down. See *Engine Coolant Temperature Gauge on page 5-15*.

See *Overheated Engine Protection Operating Mode on page 10-22* for information on driving to a safe place in an emergency.

### ENGINE OVERHEATED STOP ENGINE

This message displays and a chime may sound if the engine cooling system reaches unsafe temperatures for operation. Stop

and turn off the vehicle as soon as it is safe to do so to avoid severe damage. This message clears when the engine has cooled to a safe operating temperature.

### Engine Oil Messages

#### CHANGE ENGINE OIL SOON

This message displays when the engine oil needs to be changed. When you change the engine oil, be sure to reset the CHANGE ENGINE OIL SOON message. See *Engine Oil Life System on page 10-9* for information on how to reset the message. See *Engine Oil on page 10-6* and *Maintenance Schedule on page 11-3* for more information.

#### ENGINE OIL HOT IDLE ENGINE

This message displays when the engine oil becomes hotter than the normal operating temperature. Stop

and allow the vehicle to idle until it cools down. See *Engine Coolant Temperature Gauge on page 5-15*.

#### OIL PRESSURE LOW STOP ENGINE

**Notice:** If you drive the vehicle while the engine oil pressure is low, severe engine damage may occur. If a low oil pressure warning appears on the Driver Information Center (DIC), stop the vehicle as soon as possible. Do not drive the vehicle until the cause of the low oil pressure is corrected. See *Engine Oil on page 10-6* for more information.

This message displays if low oil pressure levels occur. Stop the vehicle as soon as safely possible and do not operate it until the cause of the low oil pressure has been corrected. Check the oil as soon as possible and have the vehicle serviced by your dealer. See *Engine Oil on page 10-6*.

### Engine Power Messages

#### ENGINE POWER IS REDUCED

This message displays and a chime may sound when the cooling system temperature gets too hot and the engine further enters the engine coolant protection mode. See *Engine Overheating on page 10-20* for more information.

This message also displays when the vehicle's engine power is reduced. Reduced engine power can affect the vehicle's ability to accelerate. If this message is on, but there is no reduction in performance, proceed to your destination. The performance may be reduced the next time the vehicle is driven. The vehicle may be driven at a reduced speed while this message is on, but acceleration and speed may be reduced. Anytime this message stays on, the vehicle should be taken to your dealer for service as soon as possible.

## Fuel System Messages

### FUEL LEVEL LOW

This message displays and a chime may sound if the fuel level is low. Refuel as soon as possible. See *Fuel Gauge on page 5-13* and *Fuel on page 9-65* for more information.

### TIGHTEN GAS CAP

This message may display along with the check engine light on the instrument panel cluster if the vehicle's fuel cap is not tightened properly. See *Malfunction Indicator Lamp on page 5-21*. Reinstall the fuel cap fully. See *Filling the Tank on page 9-68*. The diagnostic system can determine if the fuel cap has been left off or improperly installed. A loose or missing fuel cap allows fuel to evaporate into the atmosphere. A few driving trips with the cap properly installed should turn this light and message off.

## Key and Lock Messages

### REPLACE BATTERY IN REMOTE KEY

This message displays if a Remote Keyless Entry (RKE) transmitter battery is low. The battery needs to be replaced in the transmitter. See "Battery Replacement" under *Remote Keyless Entry (RKE) System Operation on page 2-2*.

## Lamp Messages

### TURN SIGNAL ON

This message displays and a chime sounds if a turn signal is left on for 1.2 km (0.75 mi). Move the turn signal/multifunction lever to the off position.

## Object Detection System Messages

### PARK ASST BLOCKED SEE OWNERS MANUAL

This message displays if there is something interfering with the park assist system. See *Ultrasonic Parking Assist on page 9-59* for more information.

### PARK ASSIST OFF

After the vehicle has been started, this message displays to remind the driver that the URPA system has been turned off. Press the set/reset button or the trip odometer reset stem to acknowledge this message and clear it from the DIC display. To turn the URPA system back on, see *Ultrasonic Parking Assist on page 9-59*.

### SERVICE PARK ASSIST

This message displays if there is a problem with the Ultrasonic Rear Parking Assist (URPA) system. Do not use this system to help you park. See *Ultrasonic Parking Assist* on page 9-59 for more information. See your dealer for service.

### Ride Control System Messages

#### SERVICE STABILITRAK

If the vehicle has StabiliTrak and this message displays, it means there may be a problem with the StabiliTrak system. If you see this message, try to reset the system. Stop; turn off the engine for at least 15 seconds; then start the engine again. If this message still comes on, it means there is a problem. You should see your dealer for service. The vehicle is safe to drive; however, you do not have the benefit of StabiliTrak, so reduce your speed and drive accordingly.

### SERVICE TRACTION CONTROL

If the vehicle has StabiliTrak, this message displays when there is a problem with the Traction Control System (TCS). When this message displays, the system will not limit wheel spin. Adjust your driving accordingly. See your dealer for service. See *StabiliTrak® System* on page 9-53 for more information.

#### STABILITRAK INITIALIZING

If the vehicle has StabiliTrak, this message may come on if the StabiliTrak system has not fully initialized because of road conditions or the incorrect tire size. When the StabiliTrak system is fully initialized, the message will turn off. See *StabiliTrak® System* on page 9-53 for more information. If this message continues to be displayed for multiple ignition cycles and on different road surfaces, see your dealer for service.

### TRACTION XX STABILITRAK XX

This message displays when the traction control and/or StabiliTrak systems have been turned on or off. Adjust your driving accordingly. To limit wheel spin and realize the full benefits of the stability enhancement system, you should normally leave StabiliTrak on. However, you should turn StabiliTrak off if the vehicle gets stuck in sand, mud, ice, or snow and you want to rock the vehicle to attempt to free it, or if you are driving in extreme off-road conditions and require more wheel spin. See *If the Vehicle Is Stuck* on page 9-14. To turn the StabiliTrak system on or off, see *StabiliTrak® System* on page 9-53.

STABILITRAK OFF may also display when the stability control has been automatically disabled. There are several conditions that can cause this message to appear.

- One condition is overheating, which could occur if StabiliTrak activates continuously for an extended period of time.
- The message also displays if the brake system warning light is on. See *Brake System Warning Light on page 5-23*.
- The message could display if the stability system takes longer than usual to complete its diagnostic checks due to driving conditions.
- The message displays if an engine or vehicle related problem has been detected and the vehicle needs service. See your dealer.

The message turns off as soon as the conditions that caused the message to be displayed are no longer present.

## Airbag System Messages

### SERVICE AIR BAG

This message displays if there is a problem with the airbag system. Have your dealer inspect the system for problems. See *Airbag Readiness Light on page 5-17* and *Airbag System on page 3-20* for more information.

## Security Messages

### SERVICE THEFT DETERRENT SYSTEM

This message displays when there is a problem with the theft-deterrent system. The vehicle may or may not restart so you may want to take the vehicle to your dealer before turning off the engine. See *Immobilizer Operation on page 2-11* for more information.

## Starting the Vehicle Messages

### FAST IDLE ON

If your vehicle has this feature, this message displays when the fast idle feature is on. See *Fast Idle System on page 9-27* for more information.

## Tire Messages

### SERVICE TIRE MONITOR SYSTEM

If the vehicle has the Tire Pressure Monitor System (TPMS), this message displays if a part on the system is not working properly. The tire pressure light also flashes and then remains on during the same ignition cycle. See *Tire Pressure Light on page 5-26*. Several conditions may cause this message to appear. See *Tire Pressure Monitor Operation on page 10-58* for more information. If the warning

## 5-44 Instruments and Controls

---

comes on and stays on, there may be a problem with the TPMS. See your dealer.

### **TIRE LEARNING ACTIVE**

If the vehicle has the Tire Pressure Monitor System (TPMS), this message displays when the system is re-learning the tire positions on your vehicle. The tire positions must be re-learned after rotating the tires or after replacing a tire or sensor. See *Tire Inspection on page 10-61*, *Tire Rotation on page 10-61*, *Tire Pressure Monitor System on page 10-57*, and *Tire Pressure on page 10-55* for more information.

### **TIRE LOW ADD AIR TO TIRE**

If the vehicle has the Tire Pressure Monitor System (TPMS), this message displays when the pressure in one or more of the vehicle's tires is low. This message also displays LEFT FRT (left front), RIGHT FRT (right front), LEFT RR (left rear), or RIGHT RR (right rear)

to indicate the location of the low tire. The low tire pressure warning light will also come on. See *Tire Pressure Light on page 5-26*. You can receive more than one tire pressure message at a time. To read the other messages that may have been sent at the same time, press the set/reset button or the trip odometer reset stem. If a tire pressure message appears on the DIC, stop as soon as you can. Have the tire pressures checked and set to those shown on the Tire Loading Information label. See *Tires on page 10-46*, *Vehicle Load Limits on page 9-15*, and *Tire Pressure on page 10-55*. The DIC also shows the tire pressure values. See *Driver Information Center (DIC) on page 5-28*.

## **Transmission Messages**

### **GRADE BRAKING DISABLED**

This message displays when the grade braking has been disabled with the tow/haul mode button on

the end of the shift lever. See *Tow/Haul Mode on page 9-37*, *Automatic Transmission on page 9-32*, and *Cruise Control on page 9-56*.

### **GRADE BRAKING ENABLED**

This message displays when the grade braking has been enabled with the tow/haul mode button on the end of the shift lever. See *Tow/Haul Mode on page 9-37*, *Automatic Transmission on page 9-32*, and *Cruise Control on page 9-56*.

### **GRADE BRAKING ON**

This message displays when the grade braking has been activated while driving on downhill grades. This message will only appear the first time the feature is activated in an ignition cycle. See *Tow/Haul Mode on page 9-37*, *Automatic Transmission on page 9-32*, and *Cruise Control on page 9-56*.

## SERVICE 4 WHEEL DRIVE

If the vehicle has four-wheel drive, this message may display if a problem occurs with the four-wheel-drive system. If this message appears, stop as soon as possible and turn off the vehicle. Make sure the key is in the LOCK/OFF position for at least one minute and then restart the vehicle and check for the message on the DIC display. If the message is still displayed or appears again when you begin driving, the four-wheel-drive system needs service. See your dealer.

## TRANSMISSION HOT IDLE ENGINE

**Notice:** Do not drive the vehicle while the transmission fluid is overheating and the transmission temperature warning is displayed on the instrument cluster and/or DIC, or the transmission can be damaged. This could lead to costly repairs that would not be covered by the warranty.

This message displays and a chime may sound if the transmission fluid in the vehicle gets hot. Driving with the transmission fluid temperature high can cause damage to the vehicle. Stop the vehicle and let it idle to allow the transmission to cool. This message clears and the chime stops when the fluid temperature reaches a safe level.

## Vehicle Reminder Messages

### CHECK TRAILER WIRING

On vehicles with the Integrated Trailer Brake Control (ITBC) system, this message may display and a chime may sound when one of the following conditions exists:

- A trailer with electric brakes becomes disconnected from the vehicle.
  - If the disconnect occurs while the vehicle is stopped, this message clears itself after a short time.

- If the disconnect occurs while the vehicle is moving, this message stays on until the ignition is turned off.
- There is a short in the wiring to the electric trailer brakes.

When this message displays, power is no longer available to the trailer brakes.

As soon as it is safe to do so, carefully pull the vehicle over to the side of the road and turn the ignition off. Check the wiring connection to the trailer and turn the ignition back on. This message clears if the trailer is reconnected. This message also clears if you acknowledge it. If this message still displays, either the vehicle or the trailer needs service. See your dealer.

See “Integrated Trailer Brake Control System” under *Towing Equipment on page 9-89* for more information.

### ICE POSSIBLE DRIVE WITH CARE

This message displays when ice conditions are possible.

### TRAILER CONNECTED

On vehicles with the Integrated Trailer Brake Control (ITBC) system, this message displays briefly when a trailer with electric brakes is first connected to the vehicle.

This message clears itself after several seconds. This message also clears if you acknowledge it. After this message clears, the TRAILER GAIN/OUTPUT display appears in the DIC.

See “TRAILER GAIN/OUTPUT” under *Driver Information Center (DIC) on page 5-28* and “Integrated Trailer Brake Control System” under *Towing Equipment on page 9-89* for more information.

### Washer Fluid Messages

#### WASHER FLUID LOW ADD FLUID

This message displays when the windshield washer fluid is low. Fill the windshield washer fluid reservoir as soon as possible. See *Engine Compartment Overview on page 10-5* for the location of the windshield washer fluid reservoir. Also, see *Washer Fluid on page 10-23* for more information.

### Vehicle Personalization

#### Vehicle Personalization (With DIC Buttons)

The vehicle may have customization capabilities that allow you to program certain features to one preferred setting. Customization features can only be programmed to one setting on the vehicle and cannot be programmed to a preferred setting for two different drivers.

All of the customization options may not be available on the vehicle. Only the options available will be displayed on the DIC.

The default settings for the customization features were set when the vehicle left the factory, but may have been changed from their default state since then.

The customization preferences are automatically recalled.



To change customization preferences, use the following procedure.

### Entering the Feature Settings Menu

1. Turn the ignition on and place the vehicle in P (Park).

To avoid excessive drain on the battery, turn the headlamps off.

2. Press the customization button to scroll through the available customizable options.

### Feature Settings Menu Items

The following customization features allow you to program settings to the vehicle:

#### DISPLAY IN ENGLISH

This feature will only display if a language other than English has been set. This feature allows you to change the language in which the DIC messages appear to English.

Press the customization button until the PRESS ✓ TO DISPLAY IN ENGLISH screen appears on the DIC display. Press the set/reset button once to display all DIC messages in English.

#### DISPLAY LANGUAGE

This feature allows you to select the language in which the DIC messages will appear.

Press the customization button until the DISPLAY LANGUAGE screen appears on the DIC display. Press the set/reset button once to access the settings for this feature. Then press the customization button to scroll through the following settings:

**ENGLISH (default):** All messages will appear in English.

**FRANCAIS:** All messages will appear in French.

**ESPANOL:** All messages will appear in Spanish.

**NO CHANGE:** No change will be made to this feature. The current setting will remain.

To select a setting, press the set/reset button while the desired setting is displayed on the DIC.

You can also change the language by pressing the trip odometer reset stem. See “Language” under *Driver Information Center (DIC)* on page 5-28 for more information.

#### AUTO DOOR LOCK

This feature allows you to select when the vehicle’s doors will automatically lock. See *Automatic Door Locks* on page 2-7 for more information.

Press the customization button until AUTO DOOR LOCK appears on the DIC display. Press the set/reset button once to access the settings for this feature. Then press the customization button to scroll through the following settings:

**SHIFT OUT OF PARK (default):**

The doors will automatically lock when the vehicle is shifted out of P (Park).

**AT VEHICLE SPEED:** The doors will automatically lock when the vehicle speed is above 13 km/h (8 mph) for three seconds.

**NO CHANGE:** No change will be made to this feature. The current setting will remain.

To select a setting, press the set/reset button while the desired setting is displayed on the DIC.

**AUTO DOOR UNLOCK**

This feature allows you to turn off the automatic door unlocking feature. It also allows you to select which doors and when the doors will automatically unlock. See *Automatic Door Locks on page 2-7* for more information.

Press the customization button until AUTO DOOR UNLOCK appears on the DIC display. Press the set/reset button once to access the settings for this feature. Then press the customization button to scroll through the following settings:

**OFF:** None of the doors will automatically unlock.

**DRIVER AT KEY OUT:** Only the driver door will unlock when the key is taken out of the ignition.

**DRIVER IN PARK:** Only the driver door will unlock when the vehicle is shifted into P (Park).

**ALL AT KEY OUT:** All of the doors will unlock when the key is taken out of the ignition.

**ALL IN PARK (default):** All of the doors will unlock when the vehicle is shifted into P (Park).

**NO CHANGE:** No change will be made to this feature. The current setting will remain.

To select a setting, press the set/reset button while the desired setting is displayed on the DIC.

**REMOTE DOOR LOCK**

This feature allows you to select the type of feedback received when locking the vehicle with the Remote Keyless Entry (RKE) transmitter. You will not receive feedback when locking the vehicle with the RKE transmitter if the doors are open. See *Remote Keyless Entry (RKE) System Operation on page 2-2* for more information.

Press the customization button until REMOTE DOOR LOCK appears on the DIC display. Press the set/reset button once to access the settings for this feature. Then press the customization button to scroll through the following settings:

**OFF:** There will be no feedback when you press the lock button on the RKE transmitter.

**LIGHTS ONLY:** The exterior lamps will flash when you press the lock button on the RKE transmitter.

**HORN ONLY:** The horn will sound on the second press of the lock button on the RKE transmitter.

**HORN & LIGHTS (default):** The exterior lamps will flash when you press the lock button on the RKE transmitter, and the horn will sound when the lock button is pressed again within five seconds of the previous command.

**NO CHANGE:** No change will be made to this feature. The current setting will remain.

To select a setting, press the set/reset button while the desired setting is displayed on the DIC.

### REMOTE DOOR UNLOCK

This feature allows you to select the type of feedback received when unlocking the vehicle with the Remote Keyless Entry (RKE) transmitter. You will not receive feedback when unlocking the vehicle with the RKE transmitter if the doors are open. See *Remote Keyless Entry (RKE) System Operation on page 2-2* for more information.

Press the customization button until REMOTE DOOR UNLOCK appears on the DIC display. Press the set/reset button once to access the settings for this feature. Then press the customization button to scroll through the following settings:

**LIGHTS OFF:** The exterior lamps will not flash when you press the unlock button on the RKE transmitter.

**LIGHTS ON (default):** The exterior lamps will flash when you press the unlock button on the RKE transmitter.

**NO CHANGE:** No change will be made to this feature. The current setting will remain.

To select a setting, press the set/reset button while the desired setting is displayed on the DIC.

### DELAY DOOR LOCK

On vehicles with a crew cab, this feature turns the delayed door locks on or off. When locking the doors with the power door lock switch and a door is open, this feature will delay locking the doors until five seconds after the last door is closed. You will hear three chimes to signal that the delayed locking feature is in use. The key must be out of the ignition for this feature to work. You can temporarily override delayed locking by pressing the power door lock switch twice. See *Delayed Locking on page 2-7* for more information.

Press the customization button until DELAY DOOR LOCK appears on the DIC display. Press the set/reset button once to access the settings for this feature. Then press the customization button to scroll through the following settings:

**OFF:** There will be no delayed locking of the vehicle's doors.

**ON (default):** The doors will not lock until five seconds after the last door is closed.

**NO CHANGE:** No change will be made to this feature. The current setting will remain.

To select a setting, press the set/reset button while the desired setting is displayed on the DIC.

### EXIT LIGHTING

This feature allows you to select the amount of time you want the exterior lamps to remain on when it is dark enough outside. This happens after the key is turned from ON/RUN to LOCK/OFF.

Press the customization button until EXIT LIGHTING appears on the DIC display. Press the set/reset button once to access the settings for this feature. Then press the customization button to scroll through the following settings:

**OFF:** The exterior lamps will not turn on.

**30 SECONDS (default):** The exterior lamps will stay on for 30 seconds.

**1 MINUTE:** The exterior lamps will stay on for one minute.

**2 MINUTES:** The exterior lamps will stay on for two minutes.

**NO CHANGE:** No change will be made to this feature. The current setting will remain.

To select a setting, press the set/reset button while the desired setting is displayed on the DIC.

### APPROACH LIGHTING

This feature allows you to select if the exterior lights turn on briefly during low light periods after unlocking the vehicle using the Remote Keyless Entry (RKE) transmitter.

Press the customization button until APPROACH LIGHTING appears on the DIC display. Press the set/reset button once to access the settings for this feature. Then press the customization button to scroll through the following settings:

**OFF:** The exterior lights will not turn on when you unlock the vehicle with the RKE transmitter.

**ON (default):** If it is dark enough outside, the exterior lights will turn on briefly when you unlock the vehicle with the RKE transmitter.

The lights will remain on for 20 seconds, until the lock button on the RKE transmitter is pressed, or until the vehicle is no longer off.

See *Remote Keyless Entry (RKE) System Operation* on page 2-2 for more information.

**NO CHANGE:** No change will be made to this feature. The current setting will remain.

To select a setting, press the set/reset button while the desired setting is displayed on the DIC.

### CHIME VOLUME

If available, this feature allows you to select the volume level of the chime.

Press the customization button until CHIME VOLUME appears on the DIC display. Press the set/reset button once to access the settings for this feature. Then press the customization button to scroll through the following settings:

**NORMAL:** The chime volume will be set to a normal level.

**LOUD:** The chime volume will be set to a loud level.

**NO CHANGE:** No change will be made to this feature. The current setting will remain.

There is no default for chime volume. The volume will stay at the last known setting.

To select a setting, press the set/reset button while the desired setting is displayed on the DIC.

### PARK TILT MIRRORS

If the vehicle has this feature, it allows you to select if the outside mirror(s) will automatically tilt down when the vehicle is shifted into R (Reverse). See *Park Tilt Mirrors* on page 2-16 for more information.

Press the customization button until PARK TILT MIRRORS appears on the DIC display. Press the set/reset button once to access the settings for this feature. Then press the customization button to scroll through the following settings:

**OFF (default):** Neither outside mirror will be tilted down when the vehicle is shifted into R (Reverse).

**DRIVER MIRROR:** The driver outside mirror will be tilted down when the vehicle is shifted into R (Reverse).

**PASSENGER MIRROR:** The passenger outside mirror will be tilted down when the vehicle is shifted into R (Reverse).

**BOTH MIRRORS:** The driver and passenger outside mirrors will be tilted down when the vehicle is shifted into R (Reverse).

**NO CHANGE:** No change will be made to this feature. The current setting will remain.

To select a setting, press the set/reset button while the desired setting is displayed on the DIC.

### EASY EXIT RECALL

If the vehicle has this feature, it allows you to select your preference for the automatic easy exit seat feature. See *Memory Seats* on page 3-6 for more information.

## 5-52 Instruments and Controls

---

Press the customization button until EASY EXIT RECALL appears on the DIC display. Press the set/reset button once to access the settings for this feature. Then press the customization button to scroll through the following settings:

**DOOR BUTTON ONLY:** No automatic seat exit recall will occur. The recall will only occur after pressing the easy exit seat button.

**BUTTON & KEY OUT (default):** If the features are enabled through the EASY EXIT SETUP menu, the driver seat will move back when the key is removed from the ignition or the easy exit seat button is pressed.

The automatic easy exit seat movement will only occur one time after the key is removed from the ignition. If the automatic movement has already occurred, and you put the key back in the ignition and remove it again, the seat will stay in the original exit position, unless a memory recall took place prior to removing the key again.

**NO CHANGE:** No change will be made to this feature. The current setting will remain.

To select a setting, press the set/reset button while the desired setting is displayed on the DIC.

### EASY EXIT SETUP

If the vehicle has this feature, it allows you to select which areas will recall with the automatic easy exit seat feature. It also allows you to turn off the automatic easy exit feature. See *Memory Seats on page 3-6* and EASY EXIT RECALL earlier for more information.

Press the customization button until EASY EXIT SETUP appears on the DIC display. Press the set/reset button once to access the settings for this feature. Then press the menu up/down button to scroll through the following settings:

**OFF:** No automatic seat exit will recall.

**SEAT ONLY (default):** The driver seat will recall.

**NO CHANGE:** No change will be made to this feature. The current setting will remain.

To select a setting, press the set/reset button while the desired setting is displayed on the DIC.

### MEMORY SEAT RECALL

If the vehicle has this feature, it allows you to select your preference for the remote memory seat recall feature. See *Memory Seats on page 3-6* for more information.

Press the customization button until MEMORY SEAT RECALL appears on the DIC display. Press the set/reset button once to access the settings for this feature. Then press the customization button to scroll through the following settings:

**OFF (default):** No remote memory seat recall will occur.

**ON:** The driver seat and, on some vehicles, the outside mirrors will automatically move to the stored driving position when the unlock button on the Remote Keyless

Entry (RKE) transmitter is pressed. On some vehicles with the adjustable throttle and brake pedal feature, the pedals will also automatically move.

**NO CHANGE:** No change will be made to this feature. The current setting will remain.

To select a setting, press the set/reset button while the desired setting is displayed on the DIC.

### REMOTE START

If your vehicle has this feature, it allows you to turn the remote start off or on. The remote start feature allows you to start the engine from outside of the vehicle using the Remote Keyless Entry (RKE) transmitter. See *Remote Vehicle Start on page 2-4* for more information.

Press the customization button until REMOTE START appears on the DIC display. Press the set/reset button once to access the settings for this feature. Then press the customization button to scroll through the following settings:

**OFF:** The remote start feature will be disabled.

**ON (default):** The remote start feature will be enabled.

**NO CHANGE:** No change will be made to this feature. The current setting will remain.

To select a setting, press the set/reset button while the desired setting is displayed on the DIC.

### FACTORY SETTINGS

This feature allows you to set all of the customization features back to their factory default settings.

Press the customization button until FACTORY SETTINGS appears on the DIC display. Press the set/reset button once to access the settings for this feature. Then press the customization button to scroll through the following settings:

**RESTORE ALL (default):** The customization features will be set to their factory default settings.

**DO NOT RESTORE:** The customization features will not be set to their factory default settings.

To select a setting, press the set/reset button while the desired setting is displayed on the DIC.

### EXIT FEATURE SETTINGS

This feature allows you to exit the feature settings menu.

Press the customization button until **PRESS ✓ TO EXIT FEATURE SETTINGS** appears in the DIC display. Press the set/reset button once to exit the menu.

If you do not exit, pressing the customization button again will return you to the beginning of the feature settings menu.

### Exiting the Feature Settings Menu

The feature settings menu will be exited when any of the following occurs:

- The vehicle is no longer in ON/RUN.
- The trip/fuel or vehicle information DIC buttons are pressed.
- The end of the feature settings menu is reached and exited.
- A 40-second time period has elapsed with no selection made.

## Universal Remote System

See *Radio Frequency Statement on page 13-20* for information regarding Part 15 of the Federal Communications Commission (FCC) rules and Industry Canada Standards RSS-GEN/210/220/310.

### Universal Remote System Programming



Vehicles with the Universal Remote System will have these buttons located in the headliner.

This system provides a way to replace up to three remote control transmitters used to activate

devices such as garage door openers, security systems, and home automation devices.

Do not use this system with any garage door opener that does not have the stop and reverse feature. This includes any garage door opener model manufactured before April 1, 1982.

Read the instructions completely before attempting to program the transmitter. Because of the steps involved, it may be helpful to have another person assist with programming the transmitter.

Be sure to keep the original remote control transmitter for use in other vehicles, as well as for future programming. Only the original remote control transmitter is needed for Fixed Code programming. The programmed buttons should be erased when the vehicle is sold or the lease ends. See “Erasing Universal Home Remote Buttons” in this section.



Park the vehicle outside of the garage when programming a garage door. Be sure that people and objects are clear of the garage door or gate that is being programmed.

### Programming Universal Home Remote — Rolling Code

For questions or help programming the Universal Home Remote System, call 1-866-572-2728 or go to [www.learcar2u.com](http://www.learcar2u.com).

Most garage door openers sold after 1996 are Rolling Code units.

Programming a garage door opener involves time-sensitive actions, so read the entire procedure before starting. Otherwise, the device will time out and the procedure will have to be repeated.

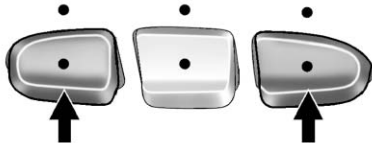

To program up to three devices:

1. From inside the vehicle, press the two outside buttons at the same time for one to two seconds, and immediately release them.

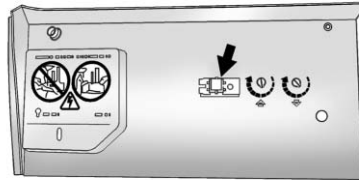

2. In the garage, locate the garage door opener receiver (motor-head unit). Find the “Learn” or “Smart” button. It can usually be found where the hanging antenna wire is attached to the motor-head unit and may be a colored button. Press this button. After pressing this button, complete the following steps in less than 30 seconds.

3. Immediately return to the vehicle. Press and hold the Universal Home Remote button that will be used to control the garage door until the garage door moves. The indicator light, above the selected button, should slowly blink. This button may need to be held for up to 20 seconds.
4. Immediately, within one second, release the button when the garage door moves. The indicator light will blink rapidly until programming is complete.
5. Press and release the same button again. The garage door should move, confirming that programming is successful and complete.

To program another Rolling Code device such as an additional garage door opener, a security device, or home automation device, repeat Steps 1 through 5, choosing a

## 5-56 Instruments and Controls

different function button in Step 3 than what was used for the garage door opener.

If these instructions do not work, the garage door opener is probably a Fixed Code unit. Follow the programming instructions that follow for a Fixed Code garage door opener.

### Programming Universal Home Remote — Fixed Code

For questions or help programming the Universal Home Remote System, call 1-866-572-2728 or go to [www.learcar2u.com](http://www.learcar2u.com).

Most garage door openers sold before 1996 are Fixed Code units.

Programming a garage door opener involves time-sensitive actions, so read the entire procedure before starting. Otherwise, the device will time out and the procedure will have to be repeated.

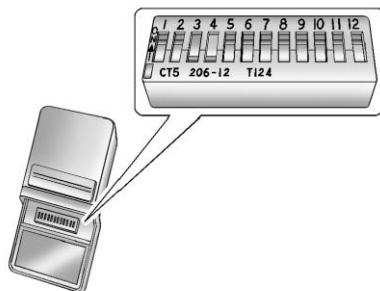

To program up to three devices:

1. To verify that the garage door opener is a Fixed Code unit, remove the battery cover on the hand-held transmitter supplied by the manufacturer of the garage door opener motor. If there is a row of dip switches similar to the graphic above, the garage door opener is a Fixed Code unit. If you do not see a row of dip switches, return to the previous section for Programming Universal Home Remote — Rolling Code.

Your hand-held transmitter can have between 8 to 12 dip switches depending on the brand of transmitter.

The garage door opener receiver (motor head unit) could also have a row of dip switches that can be used when programming the Universal Home Remote. If the total number of switches on the motor head and hand-held transmitter are different, or if the dip switch settings are different, use the dip switch settings on the motor head unit to program the Universal Home Remote. The motor head dip switch settings can also be used when the original hand-held transmitter is not available.

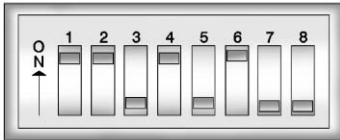

**Example of Eight Dip Switches with Two Positions**

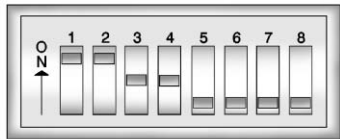

**Example of Eight Dip Switches with Three Positions**

The panel of switches might not appear exactly as they do in the examples above, but they should be similar.

The switch positions on the hand-held transmitter could be labeled as follows:

- A switch in the up position could be labeled as Up, +, or On.

- A switch in the down position could be labeled as Down, -, or Off.
  - A switch in the middle position could be labeled as Middle, 0, or Neutral.
2. Write down the 8 to 12 switch settings from left to right as follows:
- When a switch is in the up position, write "Left."
  - When a switch is in the down position, write "Right."
  - If a switch is set between the up and down position, write "Middle."

The switch settings written down in Step 2 now become the button strokes to be entered into the Universal Home Remote in Step 4. Be sure to enter the switch settings written down in Step 2, in order from left to right, into the Universal Home Remote, when completing Step 4.

3. From inside your vehicle, first firmly press all three buttons at the same time for about three seconds. Release the buttons to put the Universal Home Remote into programming mode.

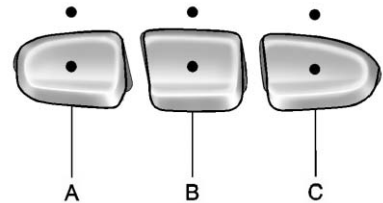

- A. Left Button (Up, +, or On)
- B. Middle Button (Middle, 0, or Neutral)
- C. Right Button (Down, -, or Off)

4. The indicator lights will blink slowly. Enter each switch setting from Step 2 into your vehicle's Universal Home Remote. You will have two and one-half minutes to complete Step 4. Now press one button on the Universal Home Remote for each switch setting as follows:
  - If you wrote "Left," press the left button (A) in the vehicle.
  - If you wrote "Right," press the right button (C) in the vehicle.
  - If you wrote "Middle," press the middle button (B) in the vehicle.
5. After entering all of the switch positions, once again firmly press and release all three buttons at the same time. The indicator lights will turn on.
6. Press and hold the button that will be used to control the garage door until the garage door moves. The indicator light above the selected button should slowly blink. This button may need to be held for up to 55 seconds.
7. Immediately release the button when the garage door moves. The indicator light will blink rapidly until programming is complete.
8. Press and release the same button again. The garage door should move, confirming that programming is successful and complete.

To program another Fixed Code device such as an additional garage door opener, a security device, or home automation device, repeat Steps 1-8, choosing a different button in Step 6 than what was used for the garage door opener.

### **Universal Remote System Operation**

Press and hold the appropriate button for at least half of a second. The indicator light will come on while the signal is being transmitted.

### **Reprogramming Universal Home Remote Buttons**

Any of the three buttons can be reprogrammed by repeating the instructions.

### Erasing Universal Home Remote Buttons

The programmed buttons should be erased when the vehicle is sold or the lease ends.

To erase either Rolling Code or Fixed Code settings on the Universal Home Remote device:

1. Press and hold the two outside buttons at the same time for approximately 20 seconds, until the indicator lights, located directly above the buttons, begin to blink rapidly.

2. Once the indicator lights begin to blink, release both buttons. The codes from all buttons will be erased.

For help or information on the Universal Home Remote System, call the customer assistance phone number under *Customer Assistance Offices (U.S. and Canada)* on page 13-5 or *Customer Assistance Offices (Mexico)* on page 13-5.



## Lighting

### Exterior Lighting

Exterior Lamp Controls .....	6-1
Exterior Lamps Off Reminder .....	6-2
Headlamp High/Low-Beam Changer .....	6-2
Flash-to-Pass .....	6-3
Daytime Running Lamps (DRL) .....	6-3
Automatic Headlamp System .....	6-3
Hazard Warning Flashers .....	6-5
Turn and Lane-Change Signals .....	6-5
Fog Lamps .....	6-6
Auxiliary Roof-Mounted Lamp .....	6-6

### Interior Lighting

Instrument Panel Illumination Control .....	6-7
Cargo Lamp .....	6-7
Dome Lamps .....	6-7
Reading Lamps .....	6-8

### Lighting Features

Entry Lighting .....	6-8
Exit Lighting .....	6-8
Battery Load Management .....	6-9
Battery Power Protection .....	6-9

## Exterior Lighting

### Exterior Lamp Controls

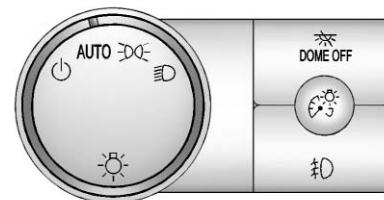

The exterior lamp control is located on the instrument panel to the left of the steering wheel.

There are four positions:

**⏻ (Off):** Turns off the automatic headlamps and Daytime Running Lamps (DRL). Turn the headlamp control to the off position again to turn the automatic headlamps or DRL back on.

For vehicles first sold in Canada, the off position will only work when the vehicle is shifted into P (Park).

## 6-2 Lighting

---

**AUTO (Automatic):** Automatically turns on the headlamps at normal brightness, together with the following:

- Parking Lamps
- Instrument Panel Lights
- Taillamps
- License Plate Lamps
- Roof Marker Lamps (If Equipped)

When the vehicle is turned off and the headlamps are in AUTO, the headlamps may automatically remain on for a set time. The time of the delay can be changed using the DIC. See *Driver Information Center (DIC) on page 5-28*.

 **(Parking Lamps):** Turns on the parking lamps together with the following:

- Instrument Panel Lights
- Taillamps
- License Plate Lamps

- Roof Marker Lamps (If Equipped)

 **(Headlamps):** Turns on the headlamps together with the following:

- Parking Lamps
- Instrument Panel Lights
- Taillamps
- License Plate Lamps
- Roof Marker Lamps (If Equipped)

When the headlamps are turned on while the vehicle is on, the headlamps turn off automatically 10 minutes after the ignition is turned off. When the headlamps are turned on while the vehicle is off, the headlamps will stay on for 10 minutes before automatically turning off to prevent the battery from being drained. Turn the headlamp control to off and then back to the headlamp on position to make the headlamps stay on for an additional 10 minutes.

Push the turn signal lever toward the instrument panel to change the headlamps from low beam to high beam.

### Exterior Lamps Off Reminder

For vehicles with a radio, a reminder chime sounds when the headlamps or parking lamps are manually turned on, the ignition is off, and a door is open. To disable the chime, turn the lamp off.

### Headlamp High/Low-Beam Changer

 **(Headlamp High/Low Beam Changer):** To change the headlamps from low to high beam, push the turn signal lever toward the instrument panel. To return to low-beam headlamps, pull the lever toward you. Then release it.





When the high beams are on, this indicator light on the instrument cluster will also be on.

## Flash-to-Pass

This feature lets you use the high-beam headlamps to signal a driver in front of you that you want to pass. It works even if the headlamps are in the automatic position.

To use it, pull the turn signal lever toward you, then release it.

If the headlamps are in the automatic position or on low beam, the high-beam headlamps will turn on. They will stay on as long as you hold the lever toward you. The high-beam indicator on the

instrument cluster will come on. Release the lever to return to normal operation.

## Daytime Running Lamps (DRL)

Daytime Running Lamps (DRL) can make it easier for others to see the front of your vehicle during the day. Fully functional daytime running lamps are required on all vehicles first sold in Canada.

The DRL system comes on when the following conditions are met:

- The ignition is on.
- The exterior lamp control is in AUTO.
- The transmission is not in Park.
- The light sensor determines it is daytime.

When the DRL system is on, only the DRL lamps are on. The taillamps, sidemarker, instrument panel lights, and other lamps will not be on.

When it begins to get dark, the automatic headlamp system switches from DRL to the headlamps.

To turn off the DRL lamps, turn the exterior lamp control to the OFF position and then release. For vehicles first sold in Canada, the transmission must be in the P (Park) position before the DRL lamps can be turned off.

## Automatic Headlamp System

When it is dark enough outside, the automatic headlamp system turns on the headlamps at the normal brightness, along with the taillamps, sidemarker, parking lamps, and the instrument panel lights. The radio lights will also be dim.

To turn off the automatic headlamp system, turn the exterior lamps switch to the off position and then release it. For vehicles first sold in Canada, the transmission must be

## 6-4 Lighting

---

in the P (Park) position before the automatic headlamp system can be turned off.

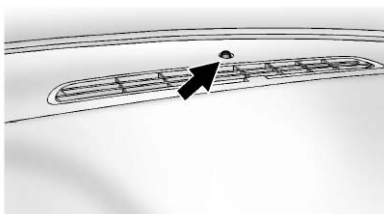

The vehicle has a light sensor located on the top of the instrument panel which regulates when the automatic headlamps turn on. Do not cover the sensor, otherwise the headlamps will come on whenever the ignition is on.

The system may also turn on the headlamps when driving through a parking garage or heavy overcast weather. This is normal.

There is a delay in the transition between the daytime and nighttime operation of the Daytime Running Lamps (DRL) and the automatic

headlamp systems so that driving under bridges or bright overhead street lights does not affect the system. The DRL and automatic headlamp system are only affected when the light sensor detects a change in lighting lasting longer than the delay.

If the vehicle is started in a dark garage, the automatic headlamp system comes on immediately. Once the vehicle leaves the garage, it takes approximately one minute for the automatic headlamp system to change to DRL if it is bright enough outside. During that delay, the instrument cluster may not be as bright as usual. Make sure the instrument panel brightness control is in the full bright position. See *Instrument Panel Illumination Control* on page 6-7.

To idle the vehicle with the automatic headlamp system off, turn the control to the off position.



The headlamps will also stay on after you exit the vehicle. This feature can be programmed using the Driver Information Center (DIC). See *Vehicle Personalization (With DIC Buttons)* on page 5-46.

If the vehicle is not equipped with DIC buttons, exit lighting is automatic. When it is dark enough outside, the exterior lamps remain on for 30 seconds after the ignition is moved from ON/RUN to LOCK/OFF.

For vehicles without a radio, the instrument panel light remains on for 30 seconds with the driver door closed. For vehicles with a radio, the instrument panel light remains on for 10 minutes with the driver door closed. See *Retained Accessory Power (RAP)* on page 9-27.

The regular headlamp system can be turned on when needed.

## Lights On with Wipers

If the windshield wipers are activated in daylight with the engine on, and the exterior lamp control is in AUTO, the headlamps, parking lamps, and other exterior lamps come on. The transition time for the lamps coming on varies based on wiper speed. When the wipers are not operating, these lamps turn off. Move the exterior lamp control to  or  to disable this feature.

## Hazard Warning Flashers

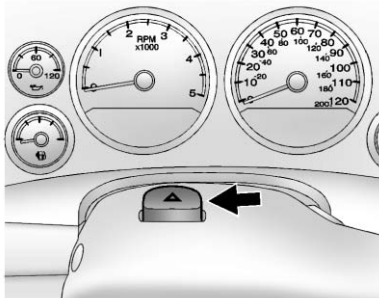

 **(Hazard Warning Flashers):** Press this button to make the front and rear turn signal lamps flash on and off. Press again to turn the flashers off.

When the hazard warning flashers are on, the vehicle's turn signals will not work.

## Turn and Lane-Change Signals

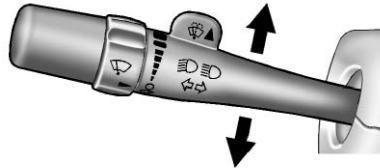

Move the lever all the way up or down to signal a turn.

An arrow on the instrument cluster flashes in the direction of the turn or lane change.

Raise or lower the lever for less than one second until the arrow starts to flash to signal a lane change. This causes the turn signals to automatically flash three times. It will flash six times if tow-haul mode is active. Holding the turn signal lever for more than one second will cause the turn signals to flash until you release the lever.

The lever returns to its starting position whenever it is released.

If after signaling a turn or a lane change the arrows flash rapidly or do not come on, a signal bulb may be burned out.

Have any burned out bulbs replaced. If a bulb is not burned out, check the fuse. See *Fuses and Circuit Breakers* on page 10-39.

## Turn Signal On Chime

If the turn signal is left on for more than 1.2 km (0.75 mi), a chime will sound at each flash of the turn signal and the message TURN

## 6-6 Lighting

SIGNAL ON will also appear in the Driver Information Control (DIC). To turn the chime and message off, move the turn signal lever to the off position.

### Fog Lamps

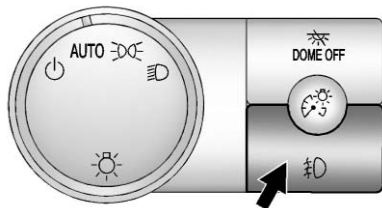

For vehicles with fog lamps, the control is located next to the exterior lamp control on the instrument panel, to the left of the steering column.

The ignition must be in the ON/RUN position for the fog lamps to come on.

**¶D (Fog Lamps):** Press to turn the fog lamps on or off. A light will come on in the instrument cluster.

When the fog lamps are turned on, the parking lamps automatically turn on.

When the headlamps are changed to high beam, the fog lamps also go off. When the high-beam headlamps are turned off, the fog lamps will come on again.

Some localities have laws that require the headlamps to be on with the fog lamps.

### Auxiliary Roof-Mounted Lamp

If the vehicle has this feature, this button includes wiring provisions for a dealer or a qualified service center to install an auxiliary roof lamp.

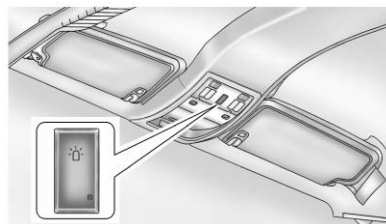

This button is on the overhead console.

When the wiring is connected to an auxiliary roof-mounted lamp, pressing the bottom of the button will activate the lamp and illuminate an indicator light at the bottom of this button. Pressing the top of the button will turn off the roof-mounted lamp and indicator.

The emergency roof lamp circuit is fused at 30 amps, so the total current draw of the attached lamps should be less than this value. The attachment points for the roof lamp circuits are two blunt cut wires located above the overhead console, a dark green switched power wire and a black ground wire.

For more information on roof mount emergency lamp installation, please visit the GM Upfitter website at [www.gmupfitter.com](http://www.gmupfitter.com) or contact your dealer.

If the vehicle has this button, the vehicle may have the snow plow prep package. See *Adding a Snow Plow or Similar Equipment on page 9-101*.

## Interior Lighting

### Instrument Panel Illumination Control

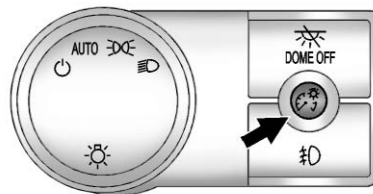

 **(Instrument Panel Brightness):** This feature controls the brightness of the instrument panel lights and is located next to the exterior lamps control.

Push the knob to extend out and then it can be turned.

Turn the knob clockwise or counterclockwise to brighten or dim the instrument panel lights. Turning the knob to the farthest clockwise position turns on the dome lamps.

### Cargo Lamp

The cargo lamps come on by turning the instrument panel brightness control knob to the farthest clockwise position. This knob is located on the instrument panel and also turns on the dome lamp.

The cargo lamps can be used if more light is needed in the cargo area of the vehicle.

### Dome Lamps

The dome lamps are located in the overhead console.

They come on when any door is opened and turn off after all the doors are closed.

Turn the instrument panel brightness knob located below the dome lamp override button, clockwise to the farthest position to manually turn on the dome lamps. The dome lamps remain on until the knob is turned counterclockwise.

## 6-8 Lighting

### Dome Lamp Override

The dome lamp override button is located next to the exterior lamps control.

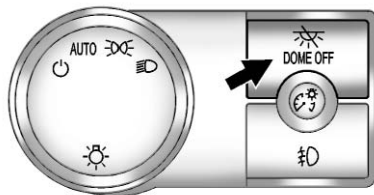

**☀ (Dome Off):** Press the button in and the dome lamps remain off when a door is opened. Press the button again to return it to the extended position so that the dome lamps come on when a door is opened.

### Reading Lamps

For vehicles with reading lamps, they are located on the overhead console.

To turn on the reading lamps, press the button located next to each lamp. To turn them off, press the button again.

The vehicle may also have reading lamps in other locations. To turn the lamps on or off, press the button located next to the lamp.

If the vehicle has a DVD Rear Seat Entertainment (RSE) system, press the lamp lenses to turn the lamps on or off.

The lamps are fixed and cannot be adjusted.

## Lighting Features

### Entry Lighting

The vehicle has an illuminated entry feature.

When the doors are opened, the dome lamps will come on if the dome override button is in the extended position. If the dome override button is pressed in, the lamps will not come on.

### Exit Lighting

The interior lamps come on when the key is removed from the ignition. They turn off automatically in 20 seconds. The lights do not come on if the dome override button is pressed in.

## Battery Load Management

The vehicle has Electric Power Management (EPM) that estimates the battery's temperature and state of charge. It then adjusts the voltage for best performance and extended life of the battery.

When the battery's state of charge is low, the voltage is raised slightly to quickly bring the charge back up. When the state of charge is high, the voltage is lowered slightly to prevent overcharging. If the vehicle has a voltmeter gauge or a voltage display on the Driver Information Center (DIC), you may see the voltage move up or down. This is normal. If there is a problem, an alert will be displayed.

The battery can be discharged at idle if the electrical loads are very high. This is true for all vehicles.

This is because the generator (alternator) may not be spinning fast enough at idle to produce all of the power needed for very high electrical loads.

A high electrical load occurs when several of the following are on, such as: headlamps, high beams, fog lamps, rear window defogger, climate control fan at high speed, heated seats, engine cooling fans, trailer loads, and loads plugged into accessory power outlets.

EPM works to prevent excessive discharge of the battery. It does this by balancing the generator's output and the vehicle's electrical needs. It can increase engine idle speed to generate more power whenever needed. It can temporarily reduce the power demands of some accessories.

Normally, these actions occur in steps or levels, without being noticeable. In rare cases at the highest levels of corrective action, this action may be noticeable to the driver. If so, a DIC message might be displayed, such as BATTERY SAVER ACTIVE, BATTERY VOLTAGE LOW, or LOW BATTERY. If one of these messages displays, it is recommended that the driver reduce the electrical loads as much as possible. See *Driver Information Center (DIC) on page 5-28*.

## Battery Power Protection

This feature shuts off the dome and reading lamps, if they are left on for more than 10 minutes after the ignition is turned off. The cargo lamp shuts off after 20 minutes. This prevents the battery from running down.





# Infotainment System

## Introduction

Infotainment .....	7-1
Theft-Deterrent Feature .....	7-2
Overview (AM-FM Radio) .....	7-3
Overview (Radio with CD (MP3)) .....	7-4
Overview (Radio with USB, CD, and DVD (MP3)) .....	7-6
Operation .....	7-7

## Radio

AM-FM Radio .....	7-10
Satellite Radio .....	7-12
Radio Reception .....	7-15
Fixed Mast Antenna .....	7-16
Satellite Radio Antenna .....	7-16

## Audio Players

CD Player .....	7-17
CD/DVD Player .....	7-23
Auxiliary Devices .....	7-33

## Rear Seat Infotainment

Rear Seat Entertainment (RSE) System .....	7-38
Rear Seat Audio (RSA) System .....	7-47

## Phone

Bluetooth .....	7-49
-----------------	------

## Trademarks and License Agreements

Trademarks and License Agreements .....	7-56
---	------

# Introduction

## Infotainment

Determine which radio the vehicle has and read the following pages to become familiar with its features.

### WARNING

Taking your eyes off the road for extended periods could cause a crash resulting in injury or death to you or others. Do not give extended attention to infotainment tasks while driving.

This system provides access to many audio and non-audio listings.

## 7-2 Infotainment System

---

To minimize taking your eyes off the road while driving, do the following while the vehicle is parked:

- Become familiar with the operation and controls of the audio system.
- Set up the tone, speaker adjustments, and preset radio stations.

For more information, see *Defensive Driving* on page 9-3.

**Notice:** Contact your dealer before adding any equipment.

**Adding audio or communication equipment could interfere with the operation of the engine, radio, or other systems, and could damage them. Follow federal rules covering mobile radio and telephone equipment.**

The vehicle has Retained Accessory Power (RAP). With RAP, the audio system can be played even after the ignition is turned off. See *Retained Accessory Power (RAP)* on page 9-27 for more information.

### Navigation/Radio System

For vehicles with a navigation radio system, see the navigation manual.

### Theft-Deterrent Feature

TheftLock<sup>®</sup> is designed to discourage theft of the vehicle's radio by learning a portion of the Vehicle Identification Number (VIN). The radio does not operate if it is stolen or moved to a different vehicle.

## Overview (AM-FM Radio)

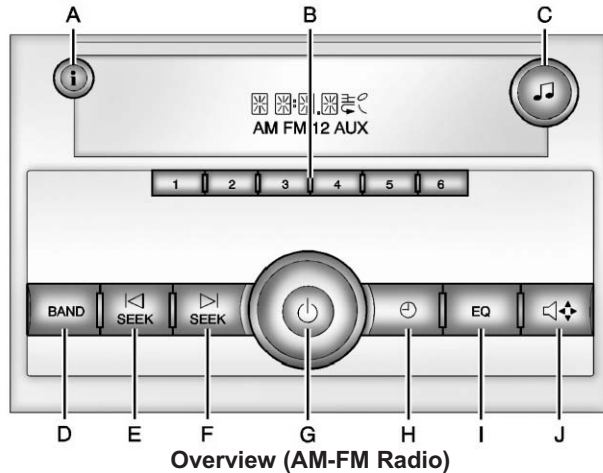

A. **i** (Information)

- Press to show information on the current station or track.

B. Buttons 1 - 6

- Saves and selects favorite stations.

C. **♪** (Tone/Tune)

- Press to set the bass or treble.
- Turn to manually select radio stations.

D. BAND

- Press to scroll through the available bands AM, FM, or XM if equipped.

E. **⏮** SEEK

- Seeks the previous station.

F. **⏭** SEEK

- Seeks the next station.

G. **⏻** (Power/Volume)

- Press to turn the infotainment system on or off.
- Turn to adjust the volume.

H. **🕒** (Clock)

- Press to set the clock.

## 7-4 Infotainment System

- I. EQ (Equalizer)
- Press to adjust the equalizer settings.
- J.  (Fade/Balance)
- Press to set the fade and balance.

### Overview (Radio with CD (MP3))

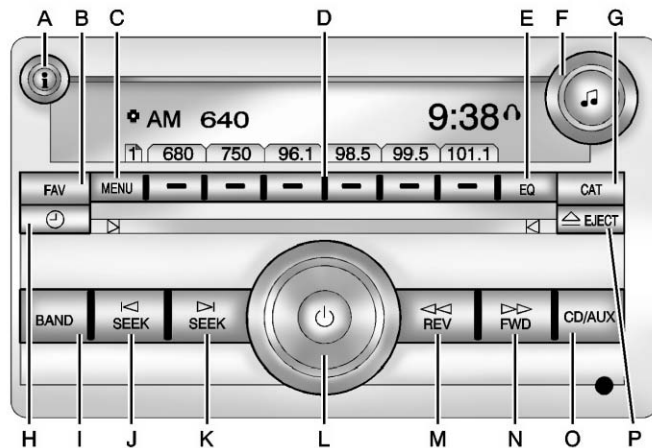

Overview (Radio with CD (MP3))

- A.  (Information)
- Press to show information on the current station or track.
- B. FAV (Favorites Pages)
- Press to scroll through the favorite pages.

C. MENU

- Press to open the tone menu to adjust the bass, midrange, treble, fade, and balance.

D. Buttons 1 - 6

- Saves and selects favorite stations.

E. EQ (Equalizer)

- Press to adjust the equalizer.

F.  (Tone/Tune)

- Press to set the bass or treble.
- Turn to manually select radio stations.

G. CAT (Category)

- Press to display a list of XM categories.

H.  (Clock)

- Press to set the clock.

I. BAND

- Press to scroll through the available bands AM, FM, or XM if equipped.

J.  SEEK

- Seeks the previous station.

K.  SEEK

- Seeks the next station.

L.  (Power/Volume)

- Press to turn the infotainment system on or off.
- Turn to adjust the volume.

M.  REV (Reverse)

- Press to and hold to go backward fast through a track.

N.  FWD (Forward)

- Press to and hold to fast forward through a track.

O. CD/AUX

- Press to scroll through selecting the CD or a auxiliary device.

P.  Eject

- Press to eject the loaded CD.

## 7-6 Infotainment System

### Overview (Radio with USB, CD, and DVD (MP3))

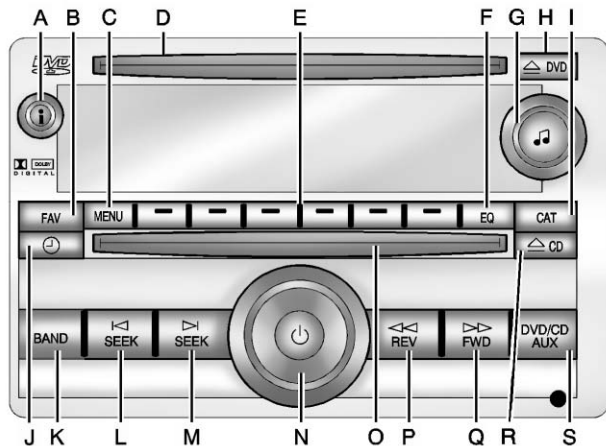

Overview (Radio with USB, CD, and DVD (MP3))

#### A. **i** (Information)

- Press to show information on the current station or track.

#### B. FAV (Favorites Pages)

- Press to scroll through the favorite pages.

#### C. MENU

- Press to open the tone menu to adjust the bass, midrange, treble, fade, and balance.

#### D. DVD Slot

#### E. Buttons 1 - 6

- Saves and selects favorite stations.

#### F. EQ (Equalizer)

- Press to adjust the equalizer settings.

#### G. **♪** (Tone/Tune)

- Press to set the bass or treble.
- Turn to manually select radio stations.

#### H. **△** DVD

- Press to eject the loaded DVD.

- I. CAT (Category)
  - Press to display a list of XM categories.
- J. ⌚ (Clock)
  - Press to set the clock.
- K. BAND
  - Press to scroll through the available bands AM, FM, or XM if equipped.
- L. ⏮ SEEK
  - Seeks the previous station.
- M. ⏭ SEEK
  - Seeks the next station.
- N. ⏻ (Power/Volume)
  - Press to turn the infotainment system on or off.
  - Turn to adjust the volume.
- O. CD Slot

- P. ⏮ REV (Reverse)
  - Press to and hold to go backward fast through a track.
- Q. ⏭ FWD (Forward)
  - Press to and hold to fast forward through a track.
- R. ⏻ CD
  - Press to eject the loaded CD.
- S. DVD/CD/AUX
  - Press to scroll through selecting the DVD, CD, or an auxiliary device.

## Operation

### Radios with CD and DVD

Vehicles with a USB, CD, and DVD radio have a Bose® Surround Sound System. Some of its features are explained later in this section, “Adjusting the Speakers (Balance/Fade).”

Vehicles with a USB, CD, and DVD radio may have a Rear Seat Entertainment (RSE) system. See *Rear Seat Entertainment (RSE) System on page 7-38* for more information on the vehicle's RSE system.

The DVD player is the top slot on the radio faceplate. The player is capable of reading the DTS-programmed DVD Audio or DVD Video media. (DTS and DTS Digital Surround are registered trademarks of Digital Theater Systems, Inc.)

Dolby and the double-D symbol are trademarks of Dolby Laboratories. Manufactured under license from Dolby Laboratories.

### Using the Radio

⏻ (**Power/Volume**): Press to turn the system on and off.

Turn clockwise or counterclockwise to increase or decrease the volume.

## 7-8 Infotainment System

---

**i (Information) (AM-FM Radio and AM-FM Radio with CD):** Press to switch the display between the radio station frequency and the time. While the ignition is off, press this button to display the time. Press to display additional text information related to the current FM-RDS or XM station; or CD, MP3, or WMA song. If information is available during XM, CD, MP3, or WMA playback, the song title information displays on the top line of the display and artist information displays on the bottom line. When information is not available, "NO INFO" displays.







**Speed Compensated Volume (SCV):** Radios with Speed Compensated Volume (SCV) automatically adjust the radio volume to compensate for road and wind noise as the vehicle's speed changes while driving, so that the volume level stays consistent.

To activate SCV:

1. Set the radio volume to the desired level.
2. Press the MENU button to display the radio setup menu.
3. Press the softkey under the AUTO VOLUM (automatic volume) tab on the radio display.
4. Press the softkey under the desired Speed Compensated Volume setting (OFF, Low, Med, or High) to select the level of radio volume compensation. The display times out after approximately 10 seconds. Each higher setting allows for more radio volume compensation at faster vehicle speeds.

### Setting the Tone (Bass/Treble) (AM-FM Radio and AM-FM Radio with CD)

To adjust the bass or treble:

1. Press the  knob until Bass or Treble displays.
2. To adjust the setting, do one of the following:
  - Turn the  knob.
  - Press either  SEEK, or  SEEK.
  - Press either  FWD, or  REV.







**EQ (Equalization):** Press this button to choose bass and treble equalization settings designed for different types of music. Selecting MANUAL, or changing bass or treble, returns the EQ to the manual bass and treble settings.

Unique EQ settings can be saved for each source.



**Setting the Tone (Bass/Midrange/Treble) (All Except AM-FM Radio and Radio with CD)**

**BASS/MID/TREB (Bass, Midrange, or Treble):** To adjust the bass, midrange, or treble:

1. Press the  knob until the tone control tabs display.
2. Highlight the desired tone control tab by doing one of the following:
  - Press the  knob.
  - Press the softkey under the desired tab.
3. Adjust the setting by doing one of the following:
  - Turn the  knob clockwise or counterclockwise.
  - Press the  SEEK, or  SEEK.
  - Press the  FWD, or  REV.

If a station's frequency is weak or if there is static, decrease the treble.

To quickly adjust bass, midrange, or treble to the middle position, press the softkey positioned under the BASS, MID, or TREB tab for more than two seconds. A beep sounds and the level adjusts to the middle position.

To quickly adjust all tone and speaker controls to the middle position, press the  knob for more than two seconds until a beep sounds.







**EQ (Equalization):** Press this button to choose bass and treble equalization settings designed for different types of music. Selecting MANUAL, or changing bass or treble, returns the EQ to the manual bass and treble settings.

Unique EQ settings can be saved for each source.

If the radio has a Bose® audio system, the EQ settings are either MANUAL or TALK.

**Adjusting the Speakers (Balance/Fade) (AM-FM Radio and AM-FM Radio with CD)**

To adjust the balance or fade:

1. Press  or press the  knob until the speaker control label displays.
2. To adjust the setting, do one of the following:
  - Turn the  knob.
  - Press either  SEEK, or  SEEK.
  - Press either  FWD, or  REV.







**Adjusting the Speakers (Balance/Fade) (All Except AM-FM Radio and Radio with CD)**

**BAL/FADE (Balance/Fade):** To adjust the balance or fade:

1. Press the  knob until the speaker control tabs display.

## 7-10 Infotainment System

---

2. Highlight the desired speaker control tab by doing one of the following:
  - Press the  knob.
  - Press the softkey under the desired tab.
3. Adjust the setting by doing one of the following:
  - Turn the  knob clockwise or counterclockwise.
  - Press the  SEEK, or  SEEK.
  - Press the  FWD, or  REV.

To quickly adjust all speaker and tone controls to the middle position, press the  knob for more than two seconds.

If the Rear Seat Audio (RSA) is turned on, the radio disables FADE and mutes the rear speakers.

### Radio Messages

**Calibration Error:** The audio system has been calibrated for the vehicle from the factory. If Calibration Error displays, it means that the radio has not been configured properly for the vehicle and it must be returned to your dealer for service.

**Locked or Loc:** One of these messages will display when the THEFTLOCK<sup>®</sup> system has locked up the radio. Take the vehicle to your dealer for service.

If any error occurs repeatedly or if an error cannot be corrected, contact your dealer.

## Radio

### AM-FM Radio

#### Radio Data System (RDS)

For radios with the Radio Data System (RDS) feature, it only works with FM stations that broadcast RDS information. This system relies upon receiving specific information from these stations and only works when the information is available. While the radio is tuned to an FM-RDS station, the station name or call letters will display. In rare cases, a radio station could broadcast incorrect information that causes the radio features to work improperly. If this happens, contact the radio station.

#### (Information) (RDS Features):

For vehicles with RDS features, press  to display additional text information related to the current FM-RDS station. If information is available, the song title information displays on the top line of the

display and artist information displays on the bottom line. When information is not available, "NO INFO" displays.

### Finding a Station

**BAND:** Press to switch between AM, FM, or SiriusXM®, if equipped.

**♪ (Tune):** Turn to manually select radio stations.

**⏪ SEEK:** Press to seek the previous radio station. Press and hold for a few seconds until a beep sounds to scan for radio stations in descending order; press the ⏪ SEEK button again to stop scanning radio stations. The radio only seeks and scans stations with a strong signal that are in the selected band.

For the AM-FM Radio, press and hold the ⏪ SEEK for four seconds until a double beep sounds to scan the preset stations. The station frequency flashes while the radio is in the scan mode.

**⏩ SEEK:** Press to seek the next radio station. Press and hold for a few seconds until a beep sounds to scan for radio stations in ascending order; press the ⏩ SEEK button again to stop scanning radio stations. The radio only seeks and scans stations with a strong signal that are in the selected band.

For the AM-FM Radio, press and hold the ⏩ SEEK for four seconds until a double beep sounds to scan the preset stations. The station frequency flashes while the radio is in the scan mode.

**⏪ REV:** Press to manually tune to a radio station in descending order.

**⏩ FWD:** Press to manually tune to a radio station in ascending order.

**FAV (Favorites):** Press to select different favorites pages for stored radio stations.

### Storing Radio Stations

Drivers are encouraged to store the radio station while the vehicle is parked; see *Defensive Driving on page 9-3*. Tune to stored radio stations using the presets, favorites button, and steering wheel controls, if the vehicle has this feature.

Radios that have a FAV button store radio stations as favorites. Up to 36 stations can be programmed as favorites using the six softkeys below the radio station frequency tabs and by using the FAV button. Press the FAV button to go through up to six pages of favorites, each having six favorite stations available per page. Each page of favorites can contain any combination of AM, FM, or SiriusXM, if equipped, stations.

Radios that do not have a FAV button store radio stations as presets. Up to 18 stations (6 FM1, 6 FM2, and 6 AM), can be programmed on the six numbered pushbuttons.

## 7-12 Infotainment System

---

### Setting Preset Stations

To store presets:

1. Tune to a radio station.
2. Press and hold one of the six numbered pushbuttons for three seconds until a beep sounds.
3. Repeat Steps 1 and 2 to store additional radio stations.

### Storing a Radio Station as a Favorite

To store a station as a favorite:

1. Tune to a radio station.
2. Press the FAV button to display the page where the station will be stored.
3. Press and hold one of the six softkeys until a beep sounds.
4. Repeat Steps 1 through 3 to store additional radio stations.

The number of favorites pages can be set up using the MENU button. To set up the number of favorites pages:

1. Press the MENU button.
2. Press the softkey located below the FAV 1-6 tab.
3. Select the number of favorites pages by pressing the softkey located below the displayed page numbers.
4. Press the FAV button, or let the menu time out, to return to the original main radio screen showing the radio station frequency tabs and to begin the process of programming favorites.

## Satellite Radio

### SiriusXM® Satellite Radio Service

SiriusXM is a satellite radio service that is based in the 48 contiguous United States and 10 Canadian

provinces. SiriusXM Satellite Radio has a wide variety of programming and commercial-free music, coast-to-coast, and in digital-quality sound. A service fee is required to receive the SiriusXM service. If the service needs to be reactivated, the radio will display "No Subscription Please Renew on channel XM1." For more information, contact SiriusXM at [www.siriusxm.com](http://www.siriusxm.com) or call 1-866-635-2349 (U.S) and [www.xmradio.ca](http://www.xmradio.ca) or call 1-877-209-0079 (Canada).

**i (Information) (SiriusXM Satellite Radio Service):** For vehicles with SiriusXM, press **i** to display additional text information related to the current SiriusXM channel. If information is available, the song title information displays on the top line of the display and artist information displays on the bottom line. When information is not available, "NO INFO" displays.

## Finding a Channel

**BAND:** Press to switch between AM, FM, or SiriusXM, if equipped.

**🎵 (Tune):** Turn to manually select an SiriusXM channel.

**⏪ SEEK:** Press to go to the previous SiriusXM channel.

**⏩ SEEK:** Press to go to the next SiriusXM channel.

**⏪ REV:** Press to go to the previous SiriusXM category.

**⏩ FWD:** Press to go to the next SiriusXM category.

**FAV (Favorites):** Press to select different favorites pages for stored radio stations.

**CAT (Category):** The CAT button is used to find SiriusXM channels when the radio is in the XM mode.

## Finding a Category (CAT) Station

To find XM channels in a category:

1. Press the CAT button to display the category tabs. Continue pressing the CAT button until the desired category name displays.
  - Radios with CD and DVD can also navigate the category list by pressing the **⏩ FWD** or the **⏪ REV** buttons.
2. Press either of the two softkeys below the desired category tab to immediately tune to the first SiriusXM station in that category.

To go to the previous or next SiriusXM station in the selected category, do one of the following:

- Turn the **🎵** knob.
- Press the softkey below the right or left arrows in the category tab.

- Press **⏪ SEEK** or **⏩ SEEK**.
3. To exit the category search mode, press the **FAV** button or **BAND** button to display the favorites again.

## Adding and Removing Categories

Categories cannot be added or removed while the vehicle is moving faster than 8 km/h (5 mph).

To add or remove a category:

1. Press the **MENU** button.
2. Press the softkey located below the XM CAT tab.
3. Turn the **🎵** knob to display the category to add or remove.
4. Press the softkey located under the Add or Remove tab.
 

To restore all removed categories, press the softkey under the Restore All tab.
5. Repeat the steps to remove more categories.

## 7-14 Infotainment System

---

### Storing SiriusXM Channels

Drivers are encouraged to store SiriusXM channels while the vehicle is parked; see *Defensive Driving on page 9-3*. Tune to stored radio stations using the presets, favorites button, and steering wheel controls, if the vehicle has this feature.

Up to 36 stations can be programmed as favorites using the six softkeys below the radio station frequency tabs and by using the FAV button. Press the FAV button to go through up to six pages of favorites, each having six favorite stations available per page. Each page of favorites can contain any combination of AM, FM, or SiriusXM, if equipped, stations.

### Storing an SiriusXM Channel as a Favorite

To store a station as a favorite:

1. Tune to an SiriusXM channel.
2. Press the FAV button to display the page where the station will be stored.

3. Press and hold one of the six softkeys until a beep sounds.
4. Repeat Steps 1 through 3 to store additional radio stations.

The number of favorites pages can be set up using the MENU button. To set up the number of favorites pages:

1. Press the MENU button.
2. Press the softkey located below the FAV 1-6 tab.
3. Select the number of favorites pages by pressing the softkey located below the displayed page numbers.
4. Press the FAV button, or let the menu time out, to return to the original main radio screen showing the radio station frequency tabs and to begin the process of programming favorites.

### SiriusXM Radio Messages

**XL (Explicit Language Channels):** These channels, or any others, can be blocked at a customer's request, by calling 1-866-635-2349 (US) or 1-877-209-0079 (Canada).

**XM Updating:** The encryption code in the receiver is being updated, and no action is required. This process should take no longer than 30 seconds.

**No XM Signal:** The system is functioning correctly, but the vehicle is in a location that is blocking the SiriusXM signal. When the vehicle is moved into an open area, the signal should return.

**Loading XM:** The audio system is acquiring and processing audio and text data. No action is needed. This message should disappear shortly.

**Channel Off Air:** This channel is not currently in service. Tune in to another channel.

**Channel Unauth:** This channel is blocked or cannot be received with your SiriusXM subscription package.

**Channel Unavail:** This previously assigned channel is no longer assigned. Tune to another station. If this station was one of the presets, choose another station for that preset button.

**No Artist Info:** No artist information is available at this time on this channel. The system is working properly.

**No Title Info:** No song title information is available at this time on this channel. The system is working properly.

**No CAT Info:** No category information is available at this time on this channel. The system is working properly.

**No Information:** No text or informational messages are available at this time on this channel. The system is working properly.

**No Subscription Please Renew:** The SiriusXM subscription needs to be reactivated. Contact SiriusXM at [www.siriusxm.com](http://www.siriusxm.com) or call 1-866-635-2349 (U.S) and [www.xmradio.ca](http://www.xmradio.ca) or call 1-877-209-0079 (Canada).

**CAT Not Found:** There are no channels available for the selected category. The system is working properly.

**XM Theftlocked:** The SiriusXM receiver in the vehicle could have previously been in another vehicle. For security purposes, SiriusXM receivers cannot be swapped between vehicles. If this message is received after having the vehicle serviced, check with your dealer.

**XM Radio ID:** If tuned to channel 0, this message alternates with the SiriusXM Radio eight-digit radio ID label. This label is needed to activate the service.

**Unknown:** If this message is received when tuned to channel 0, there could be a receiver fault. Consult with your dealer.

**Check Antenna:** If this message does not clear within a short period of time, the receiver or antenna could have a fault. Consult with your dealer.

**Check XM Receiver:** If this message does not clear within a short period of time, the receiver could have a fault. Consult with your dealer.

**XM Not Available:** If this message does not clear within a short period of time, the receiver could have a fault. Consult with your dealer.

## Radio Reception

Frequency interference and static can occur during normal radio reception if items such as cell phone chargers, vehicle convenience accessories, and external electronic devices are plugged into the accessory power outlet. If there is

interference or static, unplug the item from the accessory power outlet.

### **AM**

The range for most AM stations is greater than for FM, especially at night. The longer range can cause station frequencies to interfere with each other. For better radio reception, most AM radio stations boost the power levels during the day, and then reduce these levels during the night. Static can also occur when things like storms and power lines interfere with radio reception. When this happens, try reducing the treble on the radio.

### **FM Stereo**

FM signals only reach about 16 to 65 km (10 to 40 mi). Although the radio has a built-in electronic circuit that automatically works to reduce interference, some static can occur, especially around tall buildings or hills, causing the sound to fade in and out.

### **SiriusXM® Satellite Radio Service**

SiriusXM Satellite Radio Service gives digital radio reception from coast to coast in the 48 contiguous United States, and in Canada. Just as with FM, tall buildings or hills can interfere with satellite radio signals, causing the sound to fade in and out. In addition, traveling or standing under heavy foliage, bridges, garages, or tunnels may cause loss of the SiriusXM signal for a period of time.

### **Cellular Phone Usage**

Cellular phone usage may cause interference with the vehicle's radio. This interference may occur when making or receiving phone calls, charging the phone's battery, or simply having the phone on. This interference causes an increased level of static while listening to the radio. If static is received while listening to the radio, unplug the cellular phone and turn it off.

### **Fixed Mast Antenna**

The fixed mast antenna can withstand most car washes without being damaged as long as it is securely attached to the base. If the mast becomes slightly bent, straighten it out by hand. If the mast is badly bent, replace it.

Occasionally check to make sure the antenna is tightened to its base. If tightening is required, tighten by hand until fully seated plus one quarter turn.

### **Satellite Radio Antenna**

The XM Satellite Radio antenna is located on the roof of the vehicle. Keep the antenna clear of obstructions for clear radio reception.

If the vehicle has a sunroof, the performance of the XM system (if equipped) may be affected if the sunroof is open.



## Audio Players

### CD Player

#### Care of the CD Player

Do not add any label to a CD. It could get caught in the CD. If a CD is recorded on a personal computer and a description label is needed, try labeling the top of the recorded CD with a marking pen.

The use of CD lens cleaners is not advised, due to the risk of contaminating the lens of the CD optics with lubricants internal to the CD player mechanism.

**Notice:** If a label is added to a CD, more than one CD is inserted into the slot at a time, or an attempt is made to play scratched or damaged CDs, the CD player could be damaged. While using the CD player, use only CDs in good condition without any label, load one CD at a time, and keep

the CD player and the loading slot free of foreign materials, liquids, and debris.

If an error displays, see “CD Player Messages” later in this section.

#### Care of CDs

If playing a CD-R, the sound quality can be reduced due to CD-R or CD-RW quality, the method of recording, the quality of the music that has been recorded, and the way the CD-R or CD-RW has been handled. Handle them carefully. Store CD-Rs or CD-RWs in their original cases or other protective cases and away from direct sunlight and dust. The CD player scans the bottom surface of the disc. If the surface of a CD is damaged, such as cracked, broken, or scratched, the CD does not play properly or not at all. Do not touch the bottom side of a CD while handling it; this could damage the surface. Pick up CDs by grasping the outer edges or the edge of the hole and the outer edge.

If the surface of a CD is soiled, clean it with a soft, lint-free cloth or dampen a clean, soft cloth in a mild, neutral detergent solution mixed with water. Make sure the wiping process starts from the center to the edge.

#### Inserting a CD (Single CD Player)

Insert a CD partway into the slot, label side up. The player pulls it in and the CD should begin playing.

#### Inserting a CD(s) (Six-Disc CD Player)

**LOAD**  : Press to load CDs into the CD player. This CD player holds up to six CDs.

To insert one CD:

1. Press and release the LOAD button.
2. Wait for the message to insert the disc.

3. Load a CD. Insert the CD partway into the slot, label side up. The player pulls the CD in.

To insert multiple CDs:

1. Press and hold the LOAD button for two seconds. A beep sounds and Load All Discs displays.
2. Wait for the message on when to insert the discs. The CD player takes up to six CDs.
3. Press the LOAD button again to cancel loading more CDs.

### Ejecting a CD (Single CD Player)

 **EJECT:** Press and release to eject the disc. Remove the CD when Remove Disc displays. If the disc is not removed, after several seconds the disc is automatically pulled back into the player.

### Ejecting a CD (Six-Disc CD Player)

 **EJECT:** Press and release to eject the disc that is currently playing. Remove the CD when Remove Disc displays. If the disc is not removed, after several seconds the disc is automatically pulled back into the player.

To eject all CDs, press and hold the  EJECT button for two seconds.

### Playing a CD

If the ignition or radio is turned off with a CD in the player, it stays in the player. When the ignition or radio is turned on, the CD starts playing where it stopped, if it was the last selected audio source. The CD is controlled by the buttons on the radio faceplate or by the RSA unit. See *Rear Seat Audio (RSA) System* on page 7-47 for more information.

When a CD is inserted, the CD symbol displays on the left side of the radio display. As each new track starts to play, the track number displays.

The CD player can play the smaller 8 cm (3 in) single CDs with an adapter ring. Full-size CDs and the smaller CDs are loaded in the same manner.

**CD/AUX (CD/Auxiliary):** Press to cycle between CD or Auxiliary when listening to the radio. The CD icon and a message showing the disc and/or track number will display when a CD is in the player. Press again and the system automatically searches for an auxiliary input device; see *Auxiliary Devices* on page 7-33 for more information. If a portable audio player is not connected, “No Input Device Found” displays.

**i (Information):** Press to display additional text information related to the current song. If information is available, the song title information

displays on the top line of the display and artist information displays on the bottom line. When information is not available, "NO INFO" displays.

**♪ (Tune):** Turn to select tracks on the CD that is currently playing.

**⏮ SEEK:** Press to go to the start of the current track if more than 10 seconds on the CD have played.

Press to go to the previous track if less than 10 seconds on the CD have played.

Press and hold, or press multiple times, to continue moving backward through the tracks on the CD.

**⏭ SEEK:** Press to go to the next track.

Press and hold, or press multiple times, to continue moving forward through the tracks on the CD.

**⏮ REV (Fast Reverse):** Press and hold to reverse playback quickly within a track.

**⏭ FWD (Fast Forward):** Press and hold to advance playback quickly within a track.

**RPT (Repeat):** For the AM-FM Radio with CD, press and release the RPT button to repeat the current track. Press RPT again to turn off repeat play.

**RDM (Random):** Press to listen to tracks in random, rather than sequential order. To use random, do one of the following:

For the AM-FM Radio with CD:

1. Press the RDM button until the random icon displays.
2. Press the RDM button again until the random icon disappears from the display.

For the Radio with CD (MP3) and Radio with USB and CD (MP3):

1. Press the softkey positioned under the RDM tab until Random Current Disc displays.
2. Press the softkey again to turn off random play.

For the Radio with USB and Six-Disc CD (MP3):

1. Press the softkey positioned under the RDM tab until Randomize All Discs displays to play tracks from all CDs loaded in random order.
2. Press the softkey positioned under the RDM tab until Random Current Disc displays to play tracks from a single CD in random order.
3. Press the same softkey again to turn off random play.

### MP3-Supported Files

The Radio with CD (MP3), Radio with USB and CD (MP3), and Radio with USB and Six-Disc CD (MP3) have the capability of playing an MP3 CD-R or CD-RW disc.

### Format

Radios that have the capability of playing MP3s can play .mp3 or .wma files that were recorded onto a CD-R or CD-RW disc. The files can

be recorded with the following fixed bit rates: 32 kbps, 40 kbps, 56 kbps, 64 kbps, 80 kbps, 96 kbps, 112 kbps, 128 kbps, 160 kbps, 192 kbps, 224 kbps, 256 kbps, and 320 kbps or a variable bit rate.

### **Compressed Audio or Mixed Mode Discs**

The radio can play discs that contain both uncompressed CD audio and MP3 files. If both formats are on the disc, the radio reads all MP3 files first, then the uncompressed CD audio files.

### **CD-R- or CD-RW-Supported File and Folder Structure**

The radio supports:

- Up to 50 folders.
- Up to 8 folders in depth.
- Up to 50 playlists.
- Up to 255 files.
- Playlists with an .m3u or .wpl extension.

- Files with an .mp3, .wma, or .cda file extension.

### **Root Directory**

The root directory is treated as a folder. Files are stored in the root directory when the disc or storage device does not contain folders. Files accessed from the root directory of a CD display as F1 ROOT.

### **Empty Folder**

Folders that do not contain files are skipped, and the player advances to the next folder that contains files.

### **Order of Play**

Compressed audio files are accessed in the following order:

- Playlists (Px).
- Files stored in the root directory.
- Files stored in folders in the root directory.

Tracks are played in the following order:

- Play begins from the first track in the first playlist and continues sequentially through all tracks in each playlist. When the last track of the last playlist has played, play continues from the first track of the first playlist.
- Play begins from the first track in the first folder and continues sequentially through all tracks in each folder. When the last track of the last folder has played, play continues from the first track of the first folder.

### **File System and Naming**

The song name that displays is the song name that is contained in the ID3 tag. If the song name is not present in the ID3 tag, then the radio displays the file name without the extension (such as .mp3) as the track name.

Track names longer than 32 characters or 4 pages are shortened. The display does not show parts of words on the last page of text and the extension of the file name is not displayed.

### Preprogrammed Playlists

CDs that have preprogrammed playlists created using WinAmp™, MusicMatch™, or Real Jukebox™ software can be accessed; however, there is no playlist-editing capability using the radio. These playlists are treated as special folders containing compressed audio song files.

Playlists that have an .m3u or .pls file extension and are stored on a USB device may be supported by the radio with a USB port.

Playlists can be changed by using the softkeys below the < folder and folder > tabs, the 🎵 knob, the ⏪ SEEK button, or the ⏩ SEEK button. An MP3 CD-R or CD-RW that has been recorded without using file folders can be played. If a CD-R or CD-RW

contains more than the maximum of 50 folders, 15 playlists, and 512 folders and files, the player allows access and navigates up to the maximum, but all items over the maximum are not accessible.

### Playing an MP3

**i (Information):** Press to display additional text information related to the current song. If information is available, the song title information displays on the top line of the display and artist information displays on the bottom line. When information is not available, "NO INFO" displays.

**🎵 (Tune):** Turn to select MP3s on the CD currently playing.

**⏪ SEEK:** Press to go to the start of the track, if more than 10 seconds have played. Press and hold or press multiple times to continue moving backward through tracks.

**⏩ SEEK:** Press to go to the next track. Press and hold or press multiple times to continue moving forward through tracks.

**⏮ REV (Reverse):** Press and hold to reverse playback quickly. Sound is heard at a reduced volume and the elapsed time of the file displays. Release ⏮ REV to resume playing.

**⏭ FWD (Fast Forward):** Press and hold to advance playback quickly. Sound is heard at a reduced volume and the elapsed time of the file displays. Release ⏭ FWD to resume playing. The elapsed time of the file displays.

**< folder (Previous Folder):** Press the softkey below the < folder tab to go to the first track in the previous folder.

**folder > (Next Folder):** Press the softkey below the folder > tab to go to the first track in the next folder.

## 7-22 Infotainment System

---

**RDM (Random):** Press to listen to tracks in random, rather than sequential order. To use random, do one of the following:

For the Radio with CD (MP3) and Radio with USB and CD (MP3):

1. Press the softkey positioned under the RDM tab until Random Current Disc displays.
2. Press the softkey again to turn off random play.

For the Radio with USB and Six-Disc CD (MP3):

1. Press the softkey positioned under the RDM tab until Randomize All Discs displays to play tracks from all CDs loaded in random order.
2. Press the softkey positioned under the RDM tab until Random Current Disc displays to play tracks from a single CD in random order.
3. Press the same softkey again to turn off random play.

**⏮ (Music Navigator):** Press the softkey below the ⏮ tab to play the files in order by artist or album.

The player scans the disc to sort the files by artist and album ID3 tag information. It can take several minutes to scan the disc depending on the number of files on the disc. The radio may begin playing while it is scanning in the background.

When the scan is finished, the disc begins playing files in order by artist. The current artist playing is shown on the second line of the display. Once all songs by that artist are played, the player moves to the next artist in alphabetical order and begins playing files by that artist.

To listen to files by another artist, press the softkey located below either arrow tab. The disc goes to the next or previous artist in alphabetical order. Continue pressing either softkey below the arrow tab until the desired artist displays.

To change from playback by artist to playback by album:

1. Press the softkey located below the Sort By tab.
2. Press one of the softkeys below the Album tab from the sort screen.
3. Press the softkey below the Back tab to return to the main music navigator screen.

The album name displays on the second line between the arrows, and songs from the current album begin to play. Once all songs from that album have played, the player moves to the next album in alphabetical order on the CD and begins playing MP3s from that album.

To exit music navigator mode, press the softkey below the Back tab to return to normal MP3 playback.

## CD Player Messages

**CHECK DISC:** If this message displays and/or the CD ejects, it could be for one of the following reasons:

- It is very hot. When the temperature returns to normal, the CD should play.
- The road is very rough. When the road becomes smoother, the CD should play.
- The CD is dirty, scratched, wet, or upside down.
- The air is very humid. If so, wait about an hour and try again.
- There was a problem while burning the CD.
- The label is caught in the CD player.

If the CD is not playing correctly, for any other reason, try a known good CD.

If any error occurs repeatedly or if an error cannot be corrected, contact your dealer. If the radio

displays an error message, write it down and provide it to your dealer when reporting the problem.

## CD/DVD Player

### Care of the CD and DVD Player

Do not add any label to a disc. It could get caught in the CD or DVD player. If a disc is recorded on a personal computer and a description label is needed, try labeling the top of the recorded disc with a marking pen.

The use of CD/DVD lens cleaners is not advised, due to the risk of contaminating the lens of the optics with lubricants internal to the CD and DVD player mechanism.

**Notice:** If a label is added to a CD, more than one CD is inserted into the slot at a time, or an attempt is made to play scratched or damaged CDs, the CD player could be damaged. While using the CD player, use only CDs in good condition without any label,

load one CD at a time, and keep the CD player and the loading slot free of foreign materials, liquids, and debris.

If an error displays, see “CD Messages” later in this section.

### Care of CDs and DVDs

If playing a CD-R or CD-RW, the sound quality can be reduced due to CD-R or CD-RW quality, the method of recording, the quality of the music that has been recorded, and the way the CD-R or CD-RW has been handled. Handle them carefully. Store CD-Rs or CD-RWs in their original cases or other protective cases and away from direct sunlight and dust. The CD or DVD player scans the bottom surface of the disc. If the surface of a disc is damaged, such as cracked, broken, or scratched, the disc does not play properly or not at all. Do not touch the bottom side of a disc while handling it; this could damage the

## 7-24 Infotainment System

---

surface. Pick up discs by grasping the outer edges or the edge of the hole and the outer edge.

If the surface of a disc is soiled, clean it with a soft, lint-free cloth or dampen a clean, soft cloth in a mild, neutral detergent solution mixed with water. Make sure the wiping process starts from the center to the edge.

### Audio Output

Only one audio source can be heard through the speakers at one time. An audio source is defined as DVD slot, CD slot, XM, FM-AM, front auxiliary jack, USB port, or rear auxiliary jack.

Press the  button to turn the radio on. The radio can be heard through all of the vehicle speakers.

Front seat passengers can listen to the radio (AM, FM, or XM if equipped) by pressing the BAND button or the DVD/CD AUX button to

select CD slot, DVD slot, front auxiliary input, USB port, or rear auxiliary input (if available).

If a playback device is plugged into the radio's front auxiliary input jack, USB port, or the rear auxiliary jack, the front seat passengers are able to listen to playback from this source through the vehicle speakers. See "Using the Auxiliary Input Jack" in *Auxiliary Devices on page 7-33*, or "Audio/Video (A/V) Jacks" under *Rear Seat Entertainment (RSE) System on page 7-38* for more information.

In some vehicles, depending on audio options, the rear speakers can be muted when the RSA power is turned on. See *Rear Seat Audio (RSA) System on page 7-47* for more information.

### Inserting a Disc

Insert a disc partway into either slot, label side up. The player pulls it in and the disc should begin playing. (Loading a disc into the system, depending on media type and

format, ranges from 5 to 20 seconds for a CD, and up to 30 seconds for a DVD to begin playing.)

### Ejecting a Disc

 **CD (Eject):** Press and release to eject the disc that is currently playing. The CD ejects from the bottom slot. A beep sounds and Ejecting Disc displays. Once the disc is ejected, Remove Disc displays. The disc can be removed. If the disc is not removed, after several seconds the disc automatically pulls back into the player.

 **DVD (Eject):** Press and release to eject the disc that is currently playing in the top slot. A beep sounds and Ejecting Disc displays.

If loading and reading of a disc cannot be completed, due to unknown format, etc., and the disc fails to eject, press and hold for more than five seconds to force the disc to eject.



## Playing a CD (in Either the DVD or CD Slot)

If the ignition or radio is turned off with a CD in the player, it stays in the player. When the ignition or radio is turned on, the CD starts playing where it stopped, if it was the last selected audio source. The CD is controlled by the buttons on the radio faceplate or by the RSA unit. See *Rear Seat Audio (RSA) System on page 7-47* for more information. The DVD/CD decks (the upper slot is the DVD deck and the lower slot is the CD deck) of the radio are compatible with most audio CDs, CD-Rs, CD-RWs, and MP3s.

When a CD is inserted, the text tab DVD or CD symbol displays on the left side of the radio display. As each new track starts to play, the track number displays.

The CD player can play the smaller 8 cm (3 in) single CDs with an adapter ring. Full-size CDs and the smaller CDs are loaded in the same manner.

**DVD/CD AUX (Auxiliary):** Press to cycle through DVD, CD, or Auxiliary when listening to the radio. The DVD/CD text tab and a message showing the track or chapter number will display when a disc is in either slot. Press the DVD/CD AUX button again and the system automatically searches for an auxiliary input device; see *Auxiliary Devices on page 7-33* for more information. If a portable audio player is not connected, “No Aux Input Device” displays. If a disc is in both the DVD slot and the CD slot, the DVD/CD AUX button cycles between the two sources and does not indicate “No Aux Input Device.” If a front auxiliary device is connected, the DVD/CD AUX button cycles through all available options, such as: DVD slot, CD slot, Front Auxiliary, and Rear Auxiliary (if

available). See “Using the Auxiliary Input Jack” in *Auxiliary Devices on page 7-33* or “Audio/Video (A/V) Jacks” under *Rear Seat Entertainment (RSE) System on page 7-38* for more information.

If a disc is inserted into the top DVD slot, the rear seat operator can turn on the video screen and use the remote control to navigate the CD (tracks only) through the remote control.

**i (Information):** Press to display additional text information related to the current song. If information is available, the song title information displays on the top line of the display and artist information displays on the bottom line. When information is not available, “NO INFO” displays.

**♪ (Tune):** Turn to select tracks on the disc that is currently playing.

**⏮ (SEEK):** Press to go to the start of the current track, if more than five seconds on the CD have played.

Press to go to the previous track if less than five seconds on the CD have played.

Press and hold, or press multiple times, to continue moving backward through the tracks on the CD.

⏮ **SEEK:** Press to go to the next track.

Press and hold, or press multiple times, to continue moving forward through the tracks on the CD.

⏪ **REV (Fast Reverse):** Press and hold to reverse playback quickly within a track.

⏩ **FWD (Fast Forward):** Press and hold to advance playback quickly within a track.

**RDM (Random):** Press to listen to tracks in random, rather than sequential order. To use random:

1. Press the softkey under the RDM tab until Random Current Disc displays.
2. Press the softkey again to turn off random play.

### MP3 and WMA Supported Files

#### Format

The radio can play .mp3 or .wma files that were recorded onto a CD-R or CD-RW disc.

#### Compressed Audio or Mixed Mode Discs

The radio plays discs that contain both uncompressed CD audio and MP3/WMA files depending on which slot the disc is loaded into.

The DVD player only reads uncompressed audio and ignores MP3/WMA files on a mixed mode disc.

The CD player reads both uncompressed audio and MP3/WMA files on a mixed mode disc. Uncompressed audio is played before MP3/WMA files. Press the CAT (category) button to toggle between uncompressed audio and MP3/WMA files.

### CD-R or CD-RW Supported File and Folder Structure

The DVD player supports:

- Up to 255 folders.
- Up to eight folders in depth.
- Up to 15 playlists.
- Up to 40 sessions.
- Playlists with an .m3u or .wpl extension.
- Files with an .mp3, .wma, or .cda file extension.

The CD player supports:

- Up to 512 files and folders.
- Up to 8 folders in depth.
- Playlists with an .m3u or .wpl extension.
- Files with an .mp3, .wma, or .cda file extension.

**Root Directory**

The root directory of the disc is treated as a folder. If the root directory has compressed audio files, the directory displays as F1 ROOT on the radio.

If a disc contains both uncompressed CD audio and MP3/WMA files, a folder under the root directory called CD accesses all of the CD audio tracks on the disc.

**Empty Folder**

Folders that do not contain files are skipped, and the player advances to the next folder that contains files.

**No Folder**

When the disc contains only compressed files, the files are located under the root folder. The next and previous folder function does not function on a disc that was recorded without folders or playlists. When displaying the name of the folder, the radio displays ROOT.

When the disc contains only playlists and compressed audio files, but no folders, all files are located under the root folder. The folder down and the folder up buttons search playlists first and then go to the root folder. When the radio displays the name of the folder, the radio displays ROOT.

**Order of Play**

Compressed audio files are accessed in the following order:

- Playlists (Px).
- Files stored in the root directory.
- Files stored in folders in the root directory.

Tracks are played in the following order:

- Play begins from the first track in the first playlist and continues sequentially through all tracks in each playlist. When the last track of the last playlist has played, play continues from the first track of the first playlist.

- Play begins from the first track in the first folder and continues sequentially through all tracks in each folder. When the last track of the last folder has played, play continues from the first track of the first folder.

When play enters a new folder, the display does not automatically show the new folder name unless the folder mode has been chosen as the default display. The new track name displays.

**File System and Naming**

The song name that displays is the song name that is contained in the ID3 tag. If the song name is not present in the ID3 tag, then the radio displays the file name without the extension (such as .mp3) as the track name.

Track names longer than 32 characters or 4 pages are shortened. Parts of words on the last page of text and the extension of the file name do not display.

### Preprogrammed Playlists

Preprogrammed playlists that were created using WinAmp™, MusicMatch™, or Real Jukebox™ software can be accessed; however, they cannot be edited using the radio. These playlists are treated as special folders containing compressed audio song files.

Playlists that have an .m3u or .pls file extension and are stored on a USB device may be supported by the radio with a USB port.

### Playing an MP3 or WMA (in Either the DVD or CD Slot)

If a disc is inserted into the top DVD slot, the rear seat operator can turn on the video screen and use the remote control to navigate the CD (tracks only).

 **(Tune):** Turn to select MP3/WMA files.

 **SEEK:** Press to go to the start of the track, if more than five seconds have played. Press and hold or press multiple times, if less than



five seconds have played, to continue moving backward through tracks.



 **SEEK:** Press to go to the next track.

Press and hold, or press multiple times, to continue moving forward through tracks.

 **REV (Reverse):** Press and hold to reverse playback quickly.

 **FWD (Fast Forward):** Press and hold to advance playback quickly.



 **(Previous Folder):** Press the softkey below the  tab to go to the first track in the previous folder.

 **(Next Folder):** Press the softkey below the  tab to go to the first track in the next folder.

**RDM (Random):** Press to listen to tracks in random, rather than sequential order.

To use random:

1. Press the softkey under the RDM tab until Random Current Disc displays
2. Press the same softkey again to turn off random play.

 **(Music Navigator):** Press the softkey below the  tab to play files in order by artist or album.

The player scans the disc to sort the files by artist and album ID3 tag information. It can take several minutes to scan the disc depending on the number of files on the disc. The radio may begin playing while it is scanning in the background.

When the scan is finished, the disc begins playing files in order by artist. The current artist playing is shown on the second line of the display. Once all songs by that artist are played, the player moves to the next artist in alphabetical order and begins playing files by that artist.

To listen to files by another artist, press the softkey located below either arrow tab. The disc goes to the next or previous artist in alphabetical order. Continue pressing either softkey below the arrow tab until the artist displays.

To change from playback by artist to playback by album:

1. Press the softkey below the Sort By tab.
2. Press one of the softkeys below the Album tab from the sort screen.
3. Press the softkey below the Back tab to return to the main music navigator screen.

The album name displays on the second line between the arrows, and songs from the current album begin to play. Once all songs from that album have played, the player moves to the next album in alphabetical order on the CD and begins playing MP3 files from that album.

To exit music navigator mode, press the softkey below the Back tab to return to normal MP3 playback.

### Using the DVD Player

The DVD player can be controlled by the buttons on the remote control, the RSA system, or by the buttons on the radio faceplate. See “Remote Control” under *Rear Seat Entertainment (RSE) System on page 7-38* and *Rear Seat Audio (RSA) System on page 7-47* for more information.

The DVD player is only compatible with DVDs of the appropriate region code printed on the jacket of most DVDs.

The DVD slot of the radio is compatible with most audio CDs and CD-R/RW, DVD-Video, DVD-Audio, DVD-R/RW, and DVD +R/RW media, along with MP3 and WMA formats.

If an error message displays on the video screen or the radio, see “DVD Display Error Messages” under

*Rear Seat Entertainment (RSE) System on page 7-38*, and “CD/DVD Player Messages” later in this section for more information.

### Inserting a Disc

Insert a disc partway into the top slot, label side up. The player pulls it in and the disc should begin playing. “Loading Disc” shows on the radio display. At the same time, the radio displays a softkey menu of option(s). Some discs automatically play the movie while others default to the softkey menu display, which requires the Play, Enter, or Navigation softkeys to be pressed, either by softkey or by the rear seat passenger using the remote control.

Loading a disc into the system, depending on media type and format, ranges from 5 to 20 seconds for a CD, and up to 30 seconds for a DVD.

### Ejecting a Disc

 **DVD (Eject):** Press and release to eject the disc currently playing in the top slot. A beep sounds and Ejecting Disc displays.

If loading and reading of a disc cannot be completed, due to unknown format, etc., and the disc fails to eject, press and hold for more than five seconds to force the disc to eject.

### Playing a DVD

**DVD/CD AUX (Auxiliary):** Press to cycle through DVD, CD, or Auxiliary when listening to the radio. The DVD/CD text tab and a message showing the track or chapter number will display when a disc is in either slot. Press the DVD/CD AUX button again and the system automatically searches for an auxiliary input device; see *Auxiliary Devices on page 7-33* for more information. If a portable audio player is not connected, “No Aux Input Device” displays. If a disc is in both the DVD slot and the CD slot,

the DVD/CD AUX button cycles between the two sources and does not indicate “No Aux Input Device.” If a front auxiliary device is connected, the DVD/CD AUX button cycles through all available options, such as: DVD slot, CD slot, front auxiliary, and rear auxiliary (if available). See “Using the Auxiliary Input Jack” in *Auxiliary Devices on page 7-33* or “Audio/Video (A/V) Jacks” under *Rear Seat Entertainment (RSE) System on page 7-38* for more information.

If a disc is inserted into the top DVD slot, the rear seat operator can turn on the video screen and use the remote control to navigate the CD (tracks only) through the remote control.

 **(Power):** Press to turn the radio on or off. Turn clockwise or counterclockwise to increase or decrease the volume. Press and hold for more than two seconds to turn off the entire radio and Rear Seat Entertainment (RSE) system and to start the Parental Control

feature. Parental Control prevents the rear seat occupant from operating the Rear Seat Audio (RSA) system or remote control.

A lock symbol displays next to the clock display. The Parental Control feature remains on until the knob is pressed and held for more than two seconds again, or until the driver turns the ignition off and exits the vehicle.

 **(Tune):** Turn to select tracks on a CD or DVD.

 **SEEK:** Press to return to the start of the current track or chapter. Press again to go to the previous track or chapter. This button might not work when the DVD is playing the copyright information or the previews.

 **SEEK:** Press to go to the next track or chapter. This button might not work when the DVD is playing the copyright information or the previews.

**⏮ REV (Fast Reverse):** Press to quickly reverse the CD or DVD at five times the normal speed. To stop fast reversing, press again. This button might not work when the DVD is playing the copyright information or the previews.

**⏭ FWD (Fast Forward):** Press to fast forward the CD or DVD at five times the normal speed. To stop fast forwarding, press again. This button might not work when the DVD is playing the copyright information or the previews.

### Using Softkeys to Play a DVD-V (Video)

Once a DVD-V is inserted, the radio display menu shows several tab options for playback. Press the softkey located under any tab option during DVD-V playback.

**▶ / || (Play/Pause):** Press either the Play or Pause tab displayed on the radio, to toggle between pausing or restarting playback of a DVD. If the forward arrow is showing on the display, the system is in pause

mode. If the Pause tab is showing on the display, the system is in playback mode. If the DVD screen is off, press the play button to turn the screen on.

Some DVDs begin playing after the previews have finished, although there could be a delay of up to 30 seconds. If the DVD does not begin playing the movie automatically, press the softkey located under the play/pause symbol tag displayed on the radio. If the DVD still does not play, refer to the on-screen instructions, if available.

**■ (Stop):** Press to stop playing, rewinding, or fast forwarding a DVD.

**⏪ (Enter):** Press to select the choices that are highlighted in any menu.

**☰ (Menu):** Press to access the DVD menu. The DVD menu is different on every DVD. Use the softkeys located under the navigation arrows to navigate the cursor through the DVD menu. After

making a selection press this button. This button only operates when using a DVD.

**Nav (Navigate):** Press to display directional arrows for navigating through the menus.

**⏪ (Return):** Press to exit the current active menu and return to the previous menu. This button operates only when a DVD is playing and a menu is active.

The rear seat passenger can navigate the DVD-V and DVD-A menus and controls through the remote control. See “Remote Control” under *Rear Seat Entertainment (RSE) System on page 7-38* for more information. The video screen automatically turns on when the DVD-V is inserted into the DVD slot, and does not automatically power on when the DVD-A is inserted into the DVD slot. It must be manually turned on by the rear seat occupant through the remote control power button.

### Using Softkeys to Play a DVD-A (Audio)

Once a DVD-A is inserted, the radio display menu shows several tab options for playback. Press the softkey located under any tab option during DVD-A playback.

**▶ / || (Play/Pause):** Press either the play or pause icon displayed on the radio, to toggle between pausing or restarting playback of a DVD. If the forward arrow is showing on the display, the system is in pause mode. If the pause tab is showing on the display, the system is in playback mode.

**◀ Group ▶ :** Press to cycle through musical groupings on the DVD-A disc.



**Nav (Navigate):** Press to display directional arrows for navigating through the menus.





**🎵 (Audio Stream):** Press to cycle through audio stream formats located on the DVD-A disc. The video screen shows the audio stream changing.

The rear seat passenger can navigate the DVD-V and DVD-A menus and controls through the remote control. See “Remote Control” under *Rear Seat Entertainment (RSE) System on page 7-38* for more information. The video screen automatically turns on when the DVD-V is inserted into the DVD slot, and does not automatically power on when the DVD-A is inserted into the DVD slot. It must be manually turned on by the rear seat occupant through the remote control power button.

### Stopping and Resuming Playback

To stop playing a DVD without turning off the system, press the  button on the remote control, or press the softkey located under

the  or the  tabs displayed on the radio. If the radio is sourced to something other than DVD-V, press the DVD/CD AUX button to make DVD-V the active source.

To resume DVD playback, press the  /  button on the remote control, or press the softkey located under the  /  tab on the radio. The DVD should resume play from where it last stopped if the disc has not been ejected and the stop button has not been pressed twice on the remote control. If the disc has been ejected or the stop button has been pressed twice on the remote control, the disc resumes playing at the beginning of the disc.

### CD/DVD Player Messages

**Disc Format Error:** This message displays if the disc is inserted with the disc label wrong side up, or if the disc is damaged.

**Disc Region Error:** This message displays if the disc is not from a correct region.



**No Disc Inserted:** This message displays if no disc is present when the  or DVD/CD AUX button is pressed on the radio.

**Optical Error:** This message displays if the disc was inserted upside down.

**Disk Read Error:** This message displays if a disc was inserted with an invalid or unknown format.

**Player Error:** This message displays if there are disc load or disc eject problems.

- It is very hot. When the temperature returns to normal, the disc should play.
- The road is very rough. When the road becomes smoother, the disc should play.
- The disc is dirty, scratched, wet, or upside down.
- The air is very humid. If so, wait about an hour and try again.

- There was a problem while burning the disc.
- The label is caught in the CD/DVD player.

If the disc is not playing correctly, for any other reason, try a known good disc.

If any error occurs repeatedly or if an error cannot be corrected, contact your dealer. If the radio displays an error message, write it down and provide it to your dealer when reporting the problem.

## Auxiliary Devices

### Using the Auxiliary Input Jack

Radios with an auxiliary input jack located on the lower right side of the faceplate can connect to an external audio device such as an iPod®, MP3 player, or CD player, for use as another source for audio listening. This input jack is not an audio output; do not plug headphones into the front auxiliary input jack.

Drivers are encouraged to set up any auxiliary device while the vehicle is in P (Park). See *Defensive Driving* on page 9-3 for more information on driver distraction.

To use a portable audio player, connect a 3.5 mm (1/8 in) cable to the radio's front auxiliary input jack. When a device is connected, press the radio CD/AUX button to begin playing audio from the device over the vehicle speakers.

For optimal sound quality, increase the portable audio device's volume to the loudest level.

It is always best to power the portable audio device through its own battery while playing.

**⤵ (Power/Volume):** Turn clockwise or counterclockwise to increase or decrease the volume of the portable player. Additional volume adjustments might have to be made from the portable device if the volume is not loud or soft enough.

**BAND:** Press to listen to the radio when a portable audio device is playing. The portable audio device continues playing.

**CD/AUX (CD/Auxiliary):** Press to play a CD when a portable audio device is playing. Press again and the system begins playing audio from the connected portable audio player. If a portable audio player is not connected, “No Input Device Found” displays.

**DVD/CD AUX (DVD/CD/Auxiliary):** Press to cycle through DVD, CD, or Auxiliary when listening to the radio. The DVD/CD text tab and a message showing track or chapter number will display when a disc is in either slot. Press again and the system automatically searches for an auxiliary input device, such as a portable audio player. If a portable audio player is not connected, “No Aux Input Device” displays. If a disc is in both the DVD slot and the CD slot, the DVD/CD AUX button cycles between the two sources and does

not indicate “No Aux Input Device.” If a front auxiliary device is connected, the DVD/CD AUX button cycles through all available options, such as: DVD slot, CD slot, front auxiliary, and rear auxiliary (if available). See “Using the Auxiliary Input Jack” in this section, or “Audio/Video (A/V) Jacks” under *Rear Seat Entertainment (RSE) System on page 7-38* for more information.

### Using the USB Port

Radios with a USB port can control a USB storage device or an iPod® using the radio buttons and knobs. See “Playing an MP3” in *CD Player on page 7-17* or *CD/DVD Player on page 7-23* for information about how to connect and control a USB storage device or an iPod.

### USB Support

The USB connector is located on the instrument panel or in the center console, and uses the USB 2.0 standard.

### USB-Supported Devices

- USB flash drive
- Portable USB hard drive
- Fifth generation or later iPod
- iPod nano®
- iPod touch®
- iPod classic®

Not all iPods and USB drives are compatible with the USB port.

Make sure the iPod has the latest firmware from Apple® for proper operation. iPod firmware can be updated using the latest iTunes® application. See [www.apple.com/itunes](http://www.apple.com/itunes).

For help with identifying the iPod, go to [www.apple.com/support](http://www.apple.com/support).

Radios that have a USB port can play .mp3 and .wma files that are stored on a USB storage device as well as AAC files that are stored on an iPod.

### USB-Supported File and Folder Structure

The radio supports:

- Up to 700 folders
- Up to eight folders in depth
- Up to 65,535 files.
- Folder and file names up to 64 bytes
- Files with an .mp3 or .wma file extension
- AAC files stored on an iPod
- FAT16
- FAT32

### Connecting a USB Storage Device or iPod®

The USB port can be used to control an iPod or a USB storage device.

To connect a USB storage device, connect the device to the USB port located in the center console or on the instrument panel.

To connect an iPod, connect one end of the USB cable that came with the iPod to the iPod's dock connector and connect the other end to the USB port located in the center console or on the instrument panel. If the vehicle is on and the USB connection works, "OK to disconnect" and a GM logo may appear on the iPod, and iPod appears on the radio display. The iPod music appears on the radio's display and begins playing.

The iPod charges while it is connected to the vehicle if the vehicle is in the ACC/ACCESSORY or ON/RUN position. When the vehicle is turned off, the iPod automatically powers off and will not charge or draw power from the vehicle's battery.

If you have an older iPod model that is not supported, it can still be used by connecting it to the auxiliary input jack using a standard 3.5 mm (1/8 in) stereo cable. See "Using the Auxiliary Input Jack" earlier for more information.

### Using the Radio to Control a USB Storage Device or iPod

The radio can control a USB storage device or an iPod using the radio buttons and knobs, and display song information on the radio's display.

**🎵 (Tune):** Turn to select files.

**⏮ SEEK:** Press to go to the start of the track, if more than 10 seconds have played. Press and hold or press multiple times to continue moving backward through tracks.

**⏭ SEEK:** Press to go to the next track. Press and hold or press multiple times to continue moving forward through tracks.

**⏮ REV (Reverse):** Press and hold to reverse playback quickly. Sound is heard at a reduced volume.

Release ⏮ REV to resume playing. The elapsed time of the file displays.

**⏩ FWD (Fast Forward):** Press and hold to advance playback quickly. Sound is heard at a reduced volume. Release ⏩ FWD to resume playing. The elapsed time of the file displays.

**i (Information):** Press to display additional information about the selected track.

### Using Softkeys to Control a USB Storage Device or iPod

The five softkeys below the radio display are used to control the functions listed below.

To use the softkeys:

1. Press the first or fifth softkey below the radio display to display the functions listed below, or press the softkey below the function if it is currently displayed.
2. Press the softkey below the tab with the function on it to use that function.

**|| (Pause):** Press the softkey below **||** to pause the track. The tab appears raised when pause is being used. Press the softkey below **||** again to resume playback.

**Back:** Press the softkey below the back tab to go back to the main display screen on an iPod, or the root directory on a USB storage device.

**📁 (Folder View):** Press the softkey below 📁 to view the contents of the current folder on the USB drive. To browse and select files:

1. Press the softkey below 📁.
2. Turn 🎵 to scroll through the list of folders.
3. Press 🎵 to select the desired folder. If there is more than one folder, repeat Steps 1 and 2 until the desired folder is reached.
4. Turn 🎵 to scroll through the files in the selected folder.

5. Press 🎵 to select the desired file to be played.

To skip through large lists, the five softkeys can be used to navigate in the following order:





- First softkey, first item in the list.
- Second softkey, 1% through the list each time the softkey is pressed.
- Third softkey, 5% through the list each time the softkey is pressed.
- Fourth softkey, 10% through the list each time the softkey is pressed.
- Fifth softkey, end of the list.

**🎵 (Music Navigator):** Press the softkey below 🎵 to view and select a file on an iPod, using the iPod's menu system. Files are sorted by:

- Playlists
- Artists
- Albums

- Genres
- Songs
- Composers

To select files:

1. Press the softkey below .
2. Turn  to scroll through the list of menus.
3. Press  to select the desired menu.
4. Turn  to scroll through the folders or files in the selected menu.
5. Press  to select the desired file to be played.



To skip through large lists, the five softkeys can be used to navigate in the following order:



- First softkey, first item in the list.
- Second softkey, 1% through the list each time the softkey is pressed.



- Third softkey, 5% through the list each time the softkey is pressed.
- Fourth softkey, 10% through the list each time the softkey is pressed.
- Fifth softkey, end of the list.

### Repeat Functionality

To use Repeat:





Press the softkey below  or  to select between Repeat All and Repeat Track.



 **(Repeat All):** Press the softkey below  to repeat all tracks. The tab appears lowered when Repeat All is being used. This is the default mode when a USB storage device or iPod is first connected.



 **(Repeat Track):** Press the softkey below  to repeat one track. The tab appears raised when Repeat Track is being used.

### Shuffle Functionality



To use Shuffle:

Press the softkey below ,  S,  A, or  F to select between Shuffle Off, Shuffle All Songs/ Shuffle Songs, Shuffle Album, or Shuffle Folder.

 **(Shuffle Off):** Press the softkey below  S to turn shuffle off. This is the default mode when a USB storage device or iPod is first connected.

 S **(Shuffle All Songs/Shuffle Songs):** Press the softkey below  F or  A to shuffle all songs on the USB storage device or iPod.

 A **(Shuffle Album):** Press the softkey below  to shuffle all songs in the current album on an iPod.

 F **(Shuffle Folder):** Press the softkey below  to shuffle all songs in the current folder on a USB storage device.

### Rear Seat Infotainment

#### Rear Seat Entertainment (RSE) System

The vehicle may have a DVD Rear Seat Entertainment (RSE) system. The RSE system works with the vehicle's audio system. The DVD player is part of the front radio. The RSE system includes a radio with a DVD player, a video display screen, audio/video jacks, two wireless headphones, and a remote control. See *CD/DVD Player on page 7-23* for more information on the vehicle's CD/DVD player.

#### Before Driving

The RSE is designed for rear seat passengers only. The driver cannot safely view the video screen while driving and should not try to do so.

In severe or extreme weather conditions, the RSE system might not work until the temperature is

within the operating range. The operating range for the RSE system is above  $-20^{\circ}\text{C}$  ( $-4^{\circ}\text{F}$ ) or below  $60^{\circ}\text{C}$  ( $140^{\circ}\text{F}$ ). If the temperature of the vehicle is outside this range, heat or cool the vehicle until the temperature is within the operating range of the RSE system.

#### Parental Control

The RSE system may have a Parental Control feature, depending on which radio the vehicle has. To start Parental Control, press and hold the radio power button for more than two seconds to stop all system features such as: radio, video screen, Rear Seat Audio (RSA), DVD, and/or CD. While Parental Control is on, a padlock icon displays.

The radio can be turned back on with a single press of the power button, but the RSE system will remain under Parental Control.

To turn Parental Control off, press and hold the radio power button for more than two seconds. The RSE

returns from where it was previously left and the padlock icon disappears from the radio display.

Parental Control can also be turned off by inserting or ejecting any disc, pressing the play icon on the radio DVD display menu, or changing an ignition position.

#### Headphones

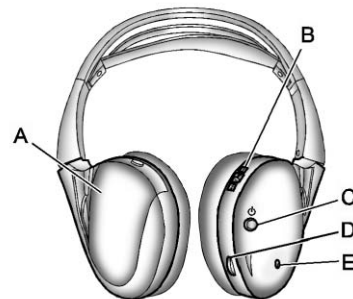

- A. Battery cover
- B. Channel 1 or 2 switch
- C. Power button
- D. Volume control
- E. Power indicator light

The RSE includes two 2-channel wireless headphones that are dedicated to this system. Channel 1 is dedicated to the video screen, while Channel 2 is dedicated to Rear Seat Audio (RSA) selections. These headphones can be used to listen to the radio, CDs, DVDs, MP3s, DVD-As, or any auxiliary source connected to A/V jacks or the auxiliary input jack, if the vehicle has this feature. The wireless headphones have a power button, channel 1 or 2 switch, and a volume control.

Push the power button to turn on the headphones. An indicator light located on the headphones comes on. If the light comes on, but there is intermittent sound and/or static on the headphones, or if the indicator light does not come on, the batteries might need to be replaced. See "Battery Replacement" later in this section for more information. Switch the headphones to Off when not in use.

Infrared transmitters are located at the rear of the overhead console. The headphones shut off automatically to save the battery power if the RSE system and RSA are shut off, or if the headphones are out of range of the transmitters for more than three minutes. If you move too far forward or step out of the vehicle, the headphones lose the audio signal.

To adjust the volume on the headphones, use the volume control located on the right side.

For optimal audio performance, the headphones must be worn correctly. Headphones should be worn with the headband over the top of the head for best audio reception. The symbol L (Left) appears on the outside bottom edge of the ear cup and should be positioned on the left ear. The symbol R (Right) appears on the outside bottom edge of the ear cup and should be positioned on the right ear.

**Notice:** Do not store the headphones in heat or direct sunlight. This could damage the headphones and repairs will not be covered by the warranty. Storage in extreme cold can weaken the batteries. Keep the headphones stored in a cool, dry place.

If the foam ear pads attached to the headphones become worn or damaged, the pads can be replaced separately from the headphone set. To purchase replacement ear pads, call 1-888-293-3332, then prompt zero (0), or contact your dealer.

### **Battery Replacement**

To change the batteries on the headphones:

1. Turn the screw to loosen the battery door located on the left side of the headphones. Slide the battery door open.

## 7-40 Infotainment System

2. Replace the two batteries in the compartment. Make sure that they are installed correctly, using the diagram on the inside of the battery compartment.
3. Replace the battery door and tighten the door screw.

If the headphones are to be stored for a long period of time, remove the batteries and keep them in a cool, dry place.

### Audio/Video (A/V) Jacks

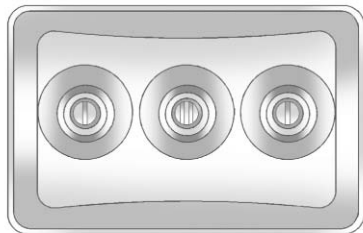

**Yellow:** Video Input

**White:** Left Audio Input

**Red:** Right Audio Input

The A/V jacks are color coded to match typical home entertainment system equipment.

The A/V jacks, located on the rear of the floor console, allow audio or video signals to be connected from an auxiliary device such as a camcorder or a video game unit to the RSE system. Adapter connectors or cables (not included) may be required to connect the auxiliary device to the A/V jacks. Refer to the manufacturer's instructions for proper usage.

Power for auxiliary devices is not supplied by the radio system.

To use the auxiliary inputs of the RSE system, connect an external auxiliary device to the color-coded A/V jacks and turn both the auxiliary device and the video screen power on. If the video screen is in the DVD player mode, pressing the AUX (auxiliary) button on the remote

control switches the video screen from the DVD player mode to the auxiliary device. The audio of the connected source can be listened to over the speakers by sourcing the radio to the auxiliary device or by sourcing the RSA to the Rear Aux and listening with the wireless headphones on Channel 2 or with the wired headphones. See "Using the Auxiliary Input Jack" under *Auxiliary Devices* on page 7-33 for more information about changing the source.

### Changing the RSE Video Screen Settings

The screen display mode (normal, full, and zoom), screen brightness, and setup menu language can be changed from the on screen setup menu. To change any feature:

1. Press the  (display menu) button on the remote control.



2. Use the remote control ▲, ▼, ◀, ▶ (navigation) arrows and the ↵ (enter) button to use the setup menu.
3. Press the □ button again to remove the setup menu from the screen.

### Audio Output

Audio from the DVD player or auxiliary inputs can be heard through the following possible sources:

- Wireless headphones
- Vehicle speakers
- Vehicle-wired headphone jacks on the RSA system, if the vehicle has this feature.

The RSE system always transmits the audio signal to the wireless headphones, if there is audio available. See “Headphones” earlier in this section for more information.

The DVD player is capable of outputting audio to the wired headphone jacks on the RSA system, if the vehicle has this feature. The DVD player can be selected as an audio source on the RSA system. See *Rear Seat Audio (RSA) System on page 7-47* for more information.

When a device is connected to the A/V jacks, or the radio’s auxiliary input jack if the vehicle has this feature, the rear seat passengers are able to hear audio from the auxiliary device through the wireless or wired headphones. The front seat passengers are able to listen to playback from this device through the vehicle speakers by selecting AUX as the source on the radio.

### Video Screen

The video screen is located in the overhead console.

To use the video screen:

1. Push the release button located on the overhead console.

2. Move the screen to the desired position.

When the video screen is not in use, push it up into its locked position.

If a DVD is playing and the screen is raised to its locked position, the screen remains on. This is normal, and the DVD continues to play through the previous audio source. Use the remote control power button or eject the disc to turn off the screen.

The overhead console contains the infrared transmitters for the wireless headphones and the infrared receivers for the remote control. They are located at the rear of the console.

**Notice:** Avoid directly touching the video screen, as damage may occur. See “Cleaning the Video Screens” later in this section for more information.

### Remote Control



To use the remote control, aim it at the transmitter window at the rear of the RSE overhead console and press the desired button. Direct sunlight or very bright light could affect the ability of the RSE transmitter to receive signals from the remote control. If the remote control does not seem to be working, the batteries might need to be replaced. See "Battery Replacement" later in this section.

Objects blocking the line of sight could also affect the function of the remote control.

If a CD or DVD is in the Radio DVD slot, the remote control  (power) button can be used to turn on the video screen display and start the disc. The radio can also turn on the video screen display. See *Operation on page 7-7* for more information.

**Notice: Storing the remote control in a hot area or in direct sunlight can damage it, and the repairs will not be covered by the warranty. Storage in extreme cold can weaken the batteries. Keep the remote control stored in a cool, dry place.**

If the remote control becomes lost or damaged, a new universal remote control can be purchased. If this happens, make sure the universal remote control uses a code set of Toshiba®.





### Remote Control Buttons

 (**Power**): Press this button to turn the video screen on and off.

 (**Illumination**): Press this button to turn the remote control backlight on. The backlight automatically times out after 7 to 10 seconds if no other button is pressed while the backlight is on.

 (**Title**): Press this button to return the DVD to the main menu of the DVD. This function could vary for each disc.

 (**Main Menu**): Press this button to access the DVD menu. The DVD menu is different on every DVD. Use the navigation arrows to move the cursor around the DVD menu. After making a selection press the enter button. This button only operates when using a DVD.

, , ,  (**Menu Navigation Arrows**): Use the arrow buttons to navigate through a menu.

 **(Enter):** Press this button to select the choice that is highlighted in any menu.

 **(Display Menu):** Press this button to adjust the brightness, screen display mode (normal, full, or zoom), and display the language menu.

 **(Return):** Press this button to exit the current active menu and return to the previous menu. This button operates only when the display menu or a DVD menu is active.

 **(Stop):** Press this button to stop playing, fast reversing, or fast forwarding a DVD. Press this button twice to return to the beginning of the DVD.

 **(Play/Pause):** Press this button to start playing a DVD. Press this button while a DVD is playing to pause it. Press it again to continue playing the DVD.

While the DVD is playing, the DVD can be played slowly by pressing the play/pause button then pressing the fast forward button. The DVD continues playing in a slow play mode. Also, reverse can be played slowly by pressing the play/pause button and then pressing the fast reverse button. To cancel slow play mode, press the play/pause button.

 **(Previous Track/Chapter):** Press this button to return to the start of the current track or chapter. Press this button again to go to the previous track or chapter. This button might not work when the DVD is playing the copyright information or the previews.

 **(Next Track/Chapter):** Press this button to go to the beginning of the next chapter or track. This button might not work while the DVD is playing the copyright information or the previews.

 **(Fast Reverse):** Press this button to quickly reverse the DVD or CD. To stop fast reversing a DVD video, press the play/pause button. To stop fast reversing a DVD audio or CD, release the fast reverse button. This button might not work when the DVD is playing the copyright information or the previews.

 **(Fast Forward):** Press this button to fast forward the DVD or CD. To stop fast forwarding a DVD video, press the play/pause button. To stop fast forwarding a DVD audio or CD, release the fast forward button. This button might not work while the DVD is playing the copyright information or the previews.

 **(Audio):** Press this button to change audio tracks on DVDs that have this feature when the DVD is playing. The format and content of this function vary for each disc.

## 7-44 Infotainment System

---

 **(Subtitles):** Press this button to turn on or off subtitles and to move through subtitle options when a DVD is playing. The format and content of this function vary for each disc.

**AUX (Auxiliary):** Press this button to switch the system between the DVD player and an auxiliary source.

 **(Camera):** Press this button to change camera angles on DVDs that have this feature while a DVD is playing. The format and content of this function vary for each disc.

**1 through 0 (Numeric Keypad):** The numeric keypad provides the capability of direct chapter or track number selection.

 **(Clear):** Press this button within three seconds after entering a numeric selection, to clear all numerical inputs.

 **(Double Digit Entries):** Press this button to select chapter or track numbers greater than nine. Press this button before entering the number.

### Battery Replacement

To change the remote control batteries, do the following:

1. Slide the rear cover back on the remote control.
2. Replace the two batteries in the compartment. Make sure they are installed correctly using the diagram on the inside of the remote control.
3. Replace the battery cover.

If the remote control is to be stored for a long period of time, remove the batteries and keep them in a cool, dry place.

**Tips and Troubleshooting Chart**

<b>Problem</b>	<b>Recommended Action</b>
There is no power.	The ignition might not be turned to ON/RUN or ACC/ACCESSORY.
The picture does not fill the screen. There are black borders on the top and bottom or on both sides, or the picture looks stretched out.	Check the display mode settings in the setup menu by pressing the display menu button on the remote control.
In auxiliary mode, the picture moves or scrolls.	Check the auxiliary input connections at both devices.
The remote control does not work.	Check to make sure there is no obstruction between the remote control and the transmitter window. Check the batteries to make sure they are not dead or installed incorrectly.
After stopping the player, and pushing Play, sometimes the DVD starts where it left off and sometimes at the beginning.	If the stop button was pressed one time, the DVD player resumes playing where the DVD was stopped. If the stop button was pressed two times, the DVD player begins to play from the beginning of the DVD.
The auxiliary source is running, but there is no picture or sound.	Check that the RSE video screen is in the auxiliary source mode. Check the auxiliary input connections at both devices.

Tips and Troubleshooting Chart (cont'd)

Problem	Recommended Action
Sometimes the wireless headphone audio cuts out or buzzes.	Check for obstructions, low batteries, reception range, and interference from cellular telephone towers, or use a cellular telephone in the vehicle. Check that the headphones are on correctly using the L (left) and R (right) on the headphones.
The remote and/or the headphones are lost.	See your dealer for assistance.
The DVD is playing, but there is no picture or sound.	Check that the RSE video screen is sourced to the DVD player.

**DVD Display Error Messages**

The DVD display error message depends on the radio that is in the vehicle. The video screen can display one of the following:

**Disc Load/Eject Error:** This message displays when there are disc load or eject problems.

**Disc Format Error:** This message displays if the disc is inserted with the disc label wrong side up, or if the disc is damaged.

**Disc Region Error:** This message displays if the disc is not from a correct region.

**No Disc Inserted:** This message displays if no disc is present when EJECT or DVD AUX is pressed on the radio.

**DVD Distortion**

Video distortion can occur when operating cellular phones, scanners, CB radios, Global Position Systems (GPS)\*, two-way radios, mobile fax machines, or walkie talkies.

It might be necessary to turn off the DVD player when operating one of these devices in or near the vehicle.

\*Excludes the OnStar® System.

**Cleaning the RSE Overhead Console**

When cleaning the RSE overhead console surface, use only a clean cloth dampened with clean water.

## Cleaning the Video Screen

When cleaning the video screen, use only a clean cloth dampened with clean water. Use care when directly touching or cleaning the screen, as damage could result.

## Rear Seat Audio (RSA) System

Vehicles with this feature allow the rear seat passengers to listen to and control any of the music sources: radio, CDs, DVDs, or other auxiliary sources. However, the rear seat passengers can only control the music sources the front seat passengers are not listening to (except on some radios where dual control is allowed). For example, rear seat passengers can control and listen to a CD through the headphones, while the driver listens to the radio through the front speakers. The rear seat passengers have control of the volume for each set of headphones.

The radio functionality is controlled by both the RSA and the front radio. Only one band can be tuned to at one time. Changing the band on the RSA or the front radio will change the band on the other system, if they are both sourced to the radio.

The RSA functions can be used even while the main radio is off. The front audio system will display the headphone icon when the RSA is on, and it will disappear from the display when the RSA is off.

Audio can be heard through wired headphones (not included) plugged into the jacks on the RSA. If the vehicle has this feature, audio can also be heard on Channel 2 of the wireless headphones.

Depending on the audio system, the rear speakers may continue to play when the RSA audio is active through the headphones.

To listen to an iPod or portable audio device through the RSA, attach the iPod or portable audio device to the front auxiliary input (if available), located on the front audio system. Turn the iPod on, then choose the front auxiliary input with the RSA SRCE button.



**Power:** Press this button to turn the RSA on or off.

**Volume:** To increase or decrease headphone volume, turn the knobs located next to the SRCE or PROG buttons. The left knob controls the left headphones and the right knob controls the right headphones.

## 7-48 Infotainment System

---

**SRCE (Source):** Press this button to switch between the radio (AM-FM), XM™ (if equipped), CD, and if the vehicle has these features, DVD, front auxiliary, and rear auxiliary.

**◀ ▶ (Seek):** When listening to FM, AM, or XM™ (if equipped), press the seek arrows to go to the previous or to the next station or channels and stay there. This function is inactive, with some radios, if the front seat passengers are listening to the radio.

Press and hold either seek arrow until the display flashes, to tune to an individual station. The display stops flashing after the buttons have not been pushed for more than two seconds. This function is inactive, with some radios, if the front seat passengers are listening to the radio.

While listening to a disc, press the left seek arrow to go back to the start of the current track or chapter (if more than 10 seconds have played). Press the right seek arrow to go the next track or chapter on the disc. This function is inactive, with some radios, if the front seat passengers are listening to the disc.

While a DVD video menu is being displayed, press either seek arrow to perform a cursor up or down on the menu. Hold either seek arrow to perform a cursor left or right on the menu.

**PROG (Program):** Press this button to go to the next preset radio station or channel set on the main radio. This function is inactive, with some radios, if the front seat passengers are listening to the radio.

While a CD or DVD-A disc is playing, press this button to go to the beginning of the CD or DVD-A. This function is inactive, with some radios, if the front seat passengers are listening to the CD or DVD-A.

While a disc is playing in the CD or DVD changer, press this button to select the next disc, if multiple discs are loaded. This function is inactive, with some radios, if the front seat passengers are listening to the disc.

While a DVD video menu is being displayed, press the PROG button to perform the menu function, Enter.



## Phone

### Bluetooth

For vehicles equipped with Bluetooth capability, the system can interact with many cell phones, allowing:

- Placement and receipt of calls in a hands-free mode.
- Sharing of the cell phone's address book or contact list with the vehicle.

To minimize driver distraction, before driving, and with the vehicle parked:

- Become familiar with the features of the cell phone. Organize the phone book and contact lists clearly and delete duplicate or rarely used entries. If possible, program speed dial or other shortcuts.
- Review the controls and operation of the infotainment system.

- Pair cell phone(s) to the vehicle. The system may not work with all cell phones. See "Pairing" in this section for more information.
- If the cell phone has voice dialing capability, learn to use that feature to access the address book or contact list. See "Voice Pass-Thru" in this section for more information.
- See "Storing and Deleting Phone Numbers" in this section for more information.

#### WARNING

When using a cell phone, it can be distracting to look too long or too often at the screen of the phone or the infotainment (navigation) system. Taking your eyes off the road too long or too often could cause a crash resulting in injury or death. Focus your attention on driving.

A Bluetooth system can use a Bluetooth-capable cell phone with a Hands-Free Profile to make and receive phone calls. The system can be used while the key is in the ON/RUN or ACC/ACCESSORY position. The range of the Bluetooth system can be up to 9.1 m (30 ft). Not all phones support all functions, and not all phones work with the in-vehicle Bluetooth system. See [www.gm.com/bluetooth](http://www.gm.com/bluetooth) for more information on compatible phones.

### Voice Recognition

The Bluetooth system uses voice recognition to interpret voice commands to dial phone numbers and name tags.

For additional information, say "Help" while you are in a voice recognition menu.

**Noise:** Keep interior noise levels to a minimum. The system may not recognize voice commands if there is too much background noise.

## 7-50 Infotainment System

---

**When to Speak:** A short tone sounds after the system responds indicating when it is waiting for a voice command. Wait until the tone and then speak.



**How to Speak:** Speak clearly in a calm and natural voice.



### Audio System

When using the in-vehicle Bluetooth system, sound comes through the vehicle's front audio system speakers and overrides the audio system. Use the audio system volume knob, during a call, to change the volume level. The adjusted volume level remains in memory for later calls. To prevent missed calls, a minimum volume level is used if the volume is turned down too low.

### Bluetooth Controls

Use the buttons on the steering wheel to operate the in-vehicle Bluetooth system. See *Steering Wheel Controls on page 5-2*.

 /  (**Push to Talk**): Press to answer incoming calls, confirm system information, and start speech recognition.

 /  (**End**): Press to end a call, reject a call, or cancel an operation.

### Pairing



A Bluetooth-enabled cell phone must be paired to the Bluetooth system and then connected to the vehicle before it can be used. See the cell phone manufacturer's user guide for Bluetooth functions before pairing the cell phone. If a Bluetooth phone is not connected, calls will be made using OnStar Hands-Free Calling, if equipped. See *OnStar Overview on page 14-1*.

### Pairing Information

- A Bluetooth phone with MP3 capability cannot be paired to the vehicle as a phone and an MP3 player at the same time.
- Up to five cell phones can be paired to the Bluetooth system.

- The pairing process is disabled when the vehicle is moving.
- Pairing only needs to be completed once, unless the pairing information on the cell phone changes or the cell phone is deleted from the system.
- Only one paired cell phone can be connected to the Bluetooth system at a time.
- If multiple paired cell phones are within range of the system, the system connects to the first available paired cell phone in the order that they were first paired to the system. To connect to a different paired phone, see "Connecting to a Different Phone" later in this section.



### Pairing a Phone

1. Press and hold  /  for two seconds.
2. Say "Bluetooth." This command can be skipped.

3. Say "Pair." The system responds with instructions and a four-digit Personal Identification Number (PIN). The PIN is used in Step 5.
4. Start the pairing process on the cell phone that you want to pair. For help with this process, see the cell phone manufacturer's user guide.
5. Locate the device named "Your Vehicle" in the list on the cell phone. Follow the instructions on the cell phone to enter the PIN provided in Step 3. After the PIN is successfully entered, the system prompts you to provide a name for the paired cell phone. This name will be used to indicate which phones are paired and connected to the vehicle. The system responds with "<phone name> has been successfully paired" after the pairing process is complete.
6. Repeat Steps 1–5 to pair additional phones.



### Listing All Paired and Connected Phones

The system can list all cell phones paired to it. If a paired cell phone is also connected to the vehicle, the system responds with "is connected" after that phone name.

1. Press and hold  /  for two seconds.
2. Say "Bluetooth."
3. Say "List."



### Deleting a Paired Phone

If the phone name you want to delete is unknown, see "Listing All Paired and Connected Phones."

1. Press and hold  /  for two seconds.
2. Say "Bluetooth."
3. Say "Delete." The system asks which phone to delete.
4. Say the name of the phone you want to delete.

### Connecting to a Different Phone

To connect to a different cell phone, the Bluetooth system looks for the next available cell phone in the order in which all the available cell phones were paired. Depending on which cell phone you want to connect to, you may have to use this command several times.

1. Press and hold  /  for two seconds.
2. Say "Bluetooth."
3. Say "Change phone."
  - If another cell phone is found, the response will be "<Phone name> is now connected."
  - If another cell phone is not found, the original phone remains connected.

### Storing and Deleting Phone Numbers

The system can store up to 30 phone numbers as name tags in the Hands-Free Directory that is shared between the Bluetooth and OnStar systems, if equipped.

The following commands are used to delete and store phone numbers.



**Store:** This command will store a phone number, or a group of numbers as a name tag.

**Digit Store:** This command allows a phone number to be stored as a name tag by entering the digits one at a time.

**Delete:** This command is used to delete individual name tags.

**Delete All Name Tags:** This command deletes all stored name tags in the Hands-Free Calling Directory and the OnStar Turn-by-Turn Destinations Directory, if equipped.



### Using the “Store” Command

1. Press and hold  /  for two seconds.
2. Say “Store.”
3. Say the phone number or group of numbers you want to store all at once with no pauses, then follow the directions given by the system to save a name tag for this number.

### Using the “Digit Store” Command



If an unwanted number is recognized by the system, say “Clear” at any time to clear the last number.

To hear all of the numbers recognized by the system, say “Verify” at any time.

1. Press and hold  /  for two seconds.
2. Say “Digit Store.”
3. Say each digit, one at a time, that you want to store. After each digit is entered, the system

repeats back the digit it heard followed by a tone. After the last digit has been entered, say “Store,” and then follow the directions given by the system to save a name tag for this number.



### Using the “Delete” Command

1. Press and hold  /  for two seconds.
2. Say “Delete.”
3. Say the name tag you want to delete.

### Using the “Delete All Name Tags” Command

This command deletes all stored name tags in the Hands-Free Calling Directory and the OnStar Turn-by-Turn Destinations Directory, if equipped.



To delete all name tags:

1. Press and hold  /  for two seconds.
2. Say “Delete all name tags.”

### Listing Stored Numbers

The list command will list all stored numbers and name tags.

#### Using the “List” Command

1. Press and hold  /  for two seconds.
2. Say “Directory.”
3. Say “Hands-Free Calling.”
4. Say “List.”

### Making a Call



Calls can be made using the following commands.

**Dial or Call:** The dial or call command can be used interchangeably to dial a phone number or a stored name tag.

**Digit Dial:** This command allows a phone number to be dialed by entering the digits one at a time.



**Re-dial:** This command is used to dial the last number used on the cell phone.

### Using the “Dial” or “Call” Command

1. Press and hold  /  for two seconds.
2. Say “Dial” or “Call.”
3. Say the entire number without pausing, or say the name tag.

Once connected, the person called will be heard through the audio speakers.

### Calling 911 Emergency

1. Press and hold  /  for two seconds.
2. Say “Dial” or “Call.”
3. Say “911.”
4. Say “Dial” or “Call.”



Once connected, the person called will be heard through the audio speakers.

### Using the “Digit Dial” Command

The digit dial command allows a phone number to be dialed by entering the digits one at a time. After each digit is entered, the system repeats back the digit it heard followed by a tone.

If an unwanted number is recognized by the system, say “Clear” at any time to clear the last number.

To hear all of the numbers recognized by the system, say “Verify” at any time.



1. Press and hold  /  for two seconds.
2. Say “Digit Dial.”
3. Say each digit, one at a time, that you want to dial. After each digit is entered, the system repeats back the digit it heard followed by a tone. After the last digit has been entered, say “Dial.”

## 7-54 Infotainment System

---

Once connected, the person called will be heard through the audio speakers.





### Using the “Re-dial” Command

1. Press and hold  /  for two seconds.
2. After the tone, say “Re-dial.”

Once connected, the person called will be heard through the audio speakers.







### Receiving a Call

When an incoming call is received, the audio system mutes and a ring tone is heard in the vehicle.

- Press  /  to answer the call.
- Press  /  to ignore a call.



### Call Waiting



Call waiting must be supported on the cell phone and enabled by the wireless service carrier.

- Press  /  to answer an incoming call when another call is active. The original call is placed on hold.
- Press  /  again to return to the original call.
- To ignore the incoming call, no action is required.
- Press  /  to disconnect the current call and switch to the call on hold.

### Three-Way Calling

Three-way calling must be supported on the cell phone and enabled by the wireless service carrier.

1. While on a call, press  / .
2. Say “Three-way call.”
3. Use the dial or call command to dial the number of the third party to be called.





4. Once the call is connected, press  /  to link all callers together.

### Ending a Call

Press  /  to end a call.

### Muting a Call

During a call, all sounds from inside the vehicle can be muted so that the person on the other end of the call cannot hear them.

- To mute a call, press  / , and then say “Mute call.”
- To cancel mute, press  / , and then say “Un-mute call.”

### Transferring a Call



Audio can be transferred between the Bluetooth system and the cell phone.

The cell phone must be paired and connected with the Bluetooth system before a call can be



transferred. The connection process can take up to two minutes after the ignition is turned to ON/RUN.

### Transferring Audio from the Bluetooth System to a Cell Phone

During a call with the audio in the vehicle:

1. Press  / .
2. Say "Transfer Call."



### Transferring Audio to the Bluetooth System from a Cell Phone

During a call with the audio on the cell phone, press  / . The audio transfers to the vehicle. If the audio does not transfer to the vehicle, use the audio transfer feature on the cell phone. See your cell phone manufacturer's user guide for more information.

### Voice Pass-Thru

Voice pass-thru allows access to the voice recognition commands on the cell phone. See your cell phone manufacturer's user guide to see if the cell phone supports this feature.

To access contacts stored in the cell phone:

1. Press and hold  /  for two seconds.
2. Say "Bluetooth." This command can be skipped.
3. Say "Voice." The system responds "OK, accessing <phone name>."



The cell phone's normal prompt messages will go through their cycle according to the phone's operating instructions.

### Dual Tone Multi-Frequency (DTMF) Tones

The Bluetooth system can send numbers and the numbers stored as name tags during a call. You can

use this feature when calling a menu-driven phone system. Account numbers can also be stored for use.

### Sending a Number or Name Tag During a Call

1. Press  / . The system responds "Ready," followed by a tone.
2. Say "Dial."
3. Say the number or name tag to send.

### Clearing the System

Unless information is deleted out of the in-vehicle Bluetooth system, it will be retained indefinitely. This includes all saved name tags in the phone book and phone pairing information. For information on how to delete this information, see the previous section "Deleting a Paired Phone" and the previous sections on deleting name tags.

**Other Information**

The Bluetooth® word mark and logos are owned by the Bluetooth® SIG, Inc. and any use of such marks by General Motors is under license. Other trademarks and trade names are those of their respective owners.

See *Radio Frequency Statement on page 13-20* for information regarding Part 15 of the Federal Communications Commission (FCC) rules and Industry Canada Standards RSS-GEN/210/220/310.

**Trademarks and License Agreements**



Manufactured under license under U.S. Patent #'s: 5,451,942; 5,956,674; 5,974,380; 5,978,762; 6,487,535 & other U.S. and worldwide patents issued & pending. DTS and the Symbol are registered trademarks and DTS Digital Surround and the DTS logos are trademarks of DTS Inc. All Rights Reserved.



Manufactured under license from Dolby Laboratories. Dolby and the double-D symbol are trademarks of Dolby Laboratories.



# Climate Controls

## Climate Control Systems

Climate Control Systems (with Air Conditioning) ..... 8-1  
 Climate Control Systems (with Heater Only) ..... 8-4  
 Dual Automatic Climate Control System ..... 8-5

## Air Vents

Air Vents ..... 8-10

# Climate Control Systems

## Climate Control Systems (with Air Conditioning)

With this system the heating, cooling, and ventilation can be controlled.

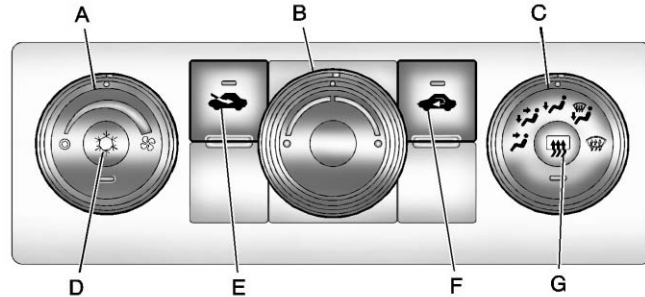

- A. Fan Control
- B. Temperature Control
- C. Air Delivery Mode Control
- D. Air Conditioning
- E. Outside Air

- F. Recirculation
- G. Rear Window Defogger

**Temperature Control:** Turn clockwise or counterclockwise to increase or decrease the temperature inside the vehicle.

## 8-2 Climate Controls

---

 **(Fan Control):** Turn clockwise or counterclockwise to increase or decrease the fan speed. Turn the knob all the way counterclockwise to turn the front system off.

**Air Delivery Mode Control:** Turn clockwise or counterclockwise to change the direction of the airflow inside the vehicle. The knob can be positioned between two modes to select a combination of those modes.

Select from the following:

 **(Vent):** Air is directed to the instrument panel outlets.

 **(Bi-Level):** Air is divided between the instrument panel and floor outlets.

 **(Floor):** Air is directed to the floor outlets, with some air directed to the windshield and side window outlets. In this mode, the system automatically selects outside air. Recirculation cannot be selected in floor mode.

 **(Defog):** This mode clears the windows of fog or moisture. Air is directed to the windshield, floor outlets, and side window vents.

 **(Defrost):** This mode removes fog or frost from the windshield more quickly. Air is directed to the windshield and the side window vents, with some air directed to the floor vents. The system automatically forces outside air into the vehicle.

The recirculation mode cannot be selected in the defog or defrost mode. When either mode is selected, the system runs the air conditioning compressor, unless the outside temperature is close to freezing.

Do not drive the vehicle until all the windows are clear.

 **(Outside Air):** Press to turn the outside air mode on. An indicator light comes on to show that outside air is on. In this mode outside air circulates throughout the vehicle. The outside air mode can be used with all modes, but it cannot be used with the recirculation mode.

 **(Recirculation):** Press to turn the recirculation mode on. An indicator light comes on to show that recirculation is on.

This mode recirculates and helps to quickly cool the air inside the vehicle. It can be used to help prevent outside air and odors from entering the vehicle.

The recirculation mode cannot be used with floor, defog or defrost modes. If recirculation is selected with one of these modes, the indicator light flashes three times and then turns off. While in recirculation mode the windows may fog when the weather is cold and damp. To clear the fog, select either the defog or defrost mode and increase the fan speed.

The recirculation mode can be turned off by pressing the outside air button, or by turning off the ignition.

 **(Air Conditioning):** Press to turn the air conditioning system on or off. An indicator light comes on to show that the air conditioning is on. The air conditioning can be selected in any mode as long as the fan switch is on.

The air conditioning system removes moisture from the air, so a small amount of water might drip under the vehicle while idling or after turning off the engine. This is normal.

### Rear Window Defogger

For vehicles with a rear window defogger, a warming grid is used to remove fog from the rear window.

 **(Rear):** Press to turn the rear window defogger on or off. An indicator light on the button comes on to show that the rear window defogger is on.

The rear window defogger only works when the ignition is in ON/RUN. The rear window defogger stays on for approximately 10 minutes after the button is pressed, unless the ignition is turned to ACC/ACCESSORY or LOCK/OFF. The defogger can also be turned off by turning off the engine.

**Notice:** Do not use anything sharp on the inside of the rear window. If you do, you could cut or damage the warming grid, and the repairs would not be covered by the vehicle warranty. Do not attach a temporary vehicle license, tape, a decal, or anything similar to the defogger grid.

## 8-4 Climate Controls

### Climate Control Systems (with Heater Only)

With this system the heating and ventilation can be controlled.

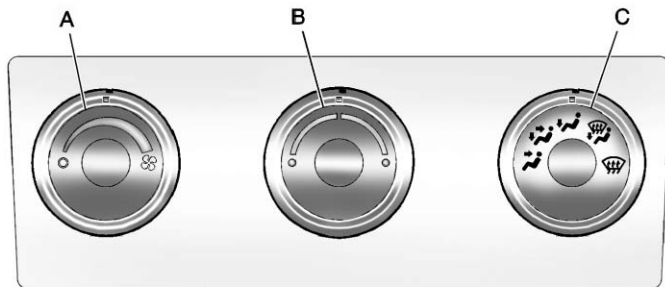

- A. Fan Control
- B. Temperature Control
- C. Air Delivery Mode Control

**Temperature Control:** Turn clockwise or counterclockwise to increase or decrease the temperature inside the vehicle.

**(Fan Control):** Turn clockwise or counterclockwise to increase or decrease the fan speed. Turn the knob all the way counterclockwise to turn the front system off.

**Air Delivery Mode Control:** Turn clockwise or counterclockwise to increase or decrease the temperature inside the vehicle. The knob can be positioned between two modes to select a combination of those modes.

Select from the following:

**(Vent):** Air is directed to the instrument panel outlets.

**(Bi-Level):** Air is divided between the instrument panel and floor outlets.

**(Floor):** Air is directed to the floor outlets, with some air directed to the windshield, side window, and second row floor outlets. In this mode, the system automatically selects outside air.

**(Defog):** This mode clears the windows of fog or moisture. Air is directed to the windshield, floor outlets, and side window vents.

 **(Defrost):** This mode removes fog or frost from the windshield more quickly. Air is directed to the windshield and the side window vents, with some air directed to the floor vents. The system automatically forces outside air into the vehicle.

Do not drive the vehicle until all the windows are clear.

### Dual Automatic Climate Control System

The heating, cooling, and ventilation in the vehicle can be controlled with this system.

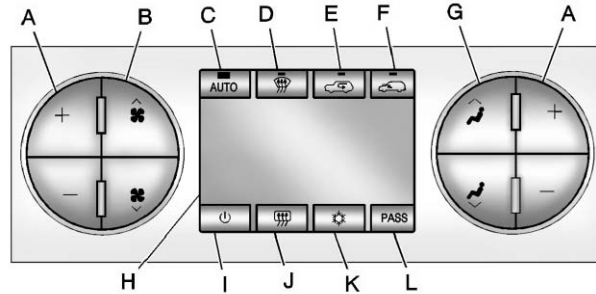



- A. Driver and Passenger Temperature Controls
- B. Fan Control
- C. AUTO
- D. Defrost
- E. Recirculation
- F. Outside Air

- G. Air Delivery Mode Control
- H. Display
- I. On/Off
- J. Rear Window Defogger
- K. Air Conditioning
- L. PASS (Passenger)

## 8-6 Climate Controls

---

**⏻ (On/Off):** Press to turn the climate control system on or off. Outside air still enters the vehicle, and is directed to the floor. This direction can be changed by pressing the mode button. Recirculation can be selected once you have selected vent or bi-level mode. The temperature can also be adjusted using either temperature button. If the air delivery mode or temperature settings are adjusted with the system off, the display illuminates briefly to show the settings and then returns to off. The system can be turned back on by pressing either , , , the defrost or the AUTO button.

### Driver and Passenger Side Temperature Controls

The driver and passenger side temperature buttons are used to adjust the temperature of the air coming through the system on the driver or passenger side of the vehicle. The temperature can be adjusted even if the system is

turned off. This is possible since outside air always flows through the system as the vehicle is moving forward unless it is set to recirculation mode. See “Recirculation” later in this section.

Press the + or – buttons to increase or decrease the cabin temperature. The driver side or passenger side temperature display shows the temperature setting increasing or decreasing.

The passenger temperature setting can be set to match the driver temperature setting by pressing the PASS button and turning off the PASS indicator. When the passenger temperature setting is set different than the driver setting, the indicator on the PASS button illuminates and both the driver side and passenger side temperature displays are shown.

When in defrost mode the passenger temperature setting cannot be changed.

### Automatic Operation

**AUTO (Automatic):** When automatic operation is active, the system controls the inside temperature, the air delivery, and the fan speed.

Use the steps below to place the entire system in automatic mode:

1. Press the AUTO button.

When AUTO is selected, the display changes to show the current temperature(s) and AUTO is lit on the display. The current air delivery mode and fan speed are also displayed for about five seconds.

When AUTO is selected, the air conditioning operation and air inlet are automatically controlled. The air conditioning compressor may run when the outside temperature is above freezing. The air inlet will normally be set to outside air. If it is hot outside, the air inlet may automatically switch to the recirculate mode to

help quickly cool down the air inside the vehicle. The light on the button comes on in recirculation.

2. Set the driver and passenger temperature.

To find your comfort setting, start with a 23°C (74°F) temperature setting and allow about 20 minutes for the system to regulate. Use the driver or passenger temperature buttons to adjust the temperature setting as necessary. If a temperature setting of 15°C (60°F) is chosen, the system remains at the maximum cooling setting. If a temperature setting of 32°C (90°F) is chosen, the system remains at the maximum heat setting. Choosing either maximum setting will not cause the vehicle to heat or cool any faster.

Do not cover the solar sensor located on the top of the instrument panel near the windshield. This

sensor regulates air temperature based on sun load. For more information on the solar sensor, see “Sensors” later in this section.

To avoid blowing cold air in cold weather, the system delays turning the fan on until warm air is available. The length of delay depends on the engine coolant temperature. Pressing the fan switch overrides this delay and changes the fan to a selected speed.

### Manual Operation

 **(Fan Control):** Press these buttons to increase or decrease the fan speed.

Pressing either fan button while in automatic control places the fan under manual control. The fan setting remains displayed and the AUTO light turns off. The air delivery mode remains under automatic control.

 **(Air Delivery Mode Control):** Press these buttons to change the direction of the airflow in the vehicle. Repeatedly press either button until the desired mode appears on the display.

Pressing either mode button while the system is off changes the air delivery mode without turning the system on.

Pressing either mode button while in automatic control places the mode under manual control. The air delivery mode setting displays and the AUTO light turns off. The fan remains under automatic control.

 **(Vent):** Air is directed to the instrument panel outlets.

 **(Bi-Level):** Air is divided between the instrument panel and floor outlets. Some air is directed toward the windshield and side window outlets.

 **(Floor):** Air is directed to the floor outlets, with some to the windshield, side window outlets, and

## 8-8 Climate Controls

---

second row floor outlets. In this mode, the system automatically selects outside air.

 **(Defog):** This mode clears the windows of fog or moisture. Air is directed to the windshield, floor outlets, and side window vents. In this mode, the system turns off recirculation and runs the air conditioning compressor unless the outside temperature is close to freezing. The recirculation mode cannot be selected while in the defrost mode.

 **(Defrost):** This mode removes fog or frost from the windshield more quickly. Air is directed to the windshield and side window vents, with some directed to the floor vents. In this mode, the system automatically forces outside air into the vehicle and runs the air conditioning compressor unless the outside temperature is close to freezing. The recirculation mode cannot be selected while in the defrost mode.

The passenger temperature control cannot be activated while in defrost mode. If the PASS button is pressed, the button indicator flashes three times and will not work. If the passenger temperature buttons are adjusted, the driver temperature indicator changes. The passenger temperature will not be displayed.

If vent, bi-level, or floor mode is selected again, the climate control system displays the previous temperature settings.

Do not drive the vehicle until all windows are clear.

 **(Air Conditioning):** Press to turn the air conditioning (A/C) compressor on and off. An indicator light comes on to show that the air conditioning is on.

If this button is pressed when the air conditioning compressor is unavailable due to outside conditions, the indicator flashes three times and then turns off. If the air conditioning is on and the outside temperature drops below a

temperature which is too cool for air conditioning to be effective, the air conditioning light turns off to show that the air conditioning mode has been canceled.

On hot days, open the windows long enough to let hot inside air escape. This helps to reduce the time it takes for the vehicle to cool down. It also helps the system to operate more efficiently.

The air conditioning system removes moisture from the air, so a small amount of water might drip under the vehicle while idling or after turning off the engine. This is normal.

 **(Recirculation):** Press to turn the recirculation mode on. An indicator light comes on to show that recirculation is on.

This mode recirculates and helps to quickly cool the air inside the vehicle. It can be used to help prevent outside air and odors from entering the vehicle.



The recirculation mode cannot be used with floor, defog, or defrost modes. If recirculation is selected with one of those modes, the indicator light flashes three times and then turns off. The air conditioning compressor also comes on when this mode is activated. While in recirculation mode, the windows may fog when the weather is cold and damp. To clear the fog, select either the defog or defrost mode and increase the fan speed.

The recirculation mode can be turned off by pressing the outside air button, or by turning off the ignition.

 **(Outside Air):** Press to turn the outside air mode on. An indicator light on the button comes on to show that outside is on. When selected, air from outside the vehicle circulates throughout the vehicle. The recirculation mode cannot be used with the outside air mode.

### Rear Window Defogger

The rear window defogger uses a warming grid to remove fog from the rear window.

 **(Rear Window Defogger):** For vehicles with this feature, press to turn the defogger on or off. It automatically turns off several minutes after it has been activated. The defogger can also be turned off by turning the engine off. Do not drive the vehicle until all windows are clear.

**Notice:** Do not use a razor blade or sharp object to clear the inside rear window. Do not adhere anything to the defogger grid lines in the rear glass. These actions may damage the rear defogger. Repairs would not be covered by your warranty.

**Heated Mirror:** For vehicles with heated outside rearview mirrors, the mirrors heat to help clear fog or frost from the surface of the mirror when

the rear window defog button is pressed. See *Power Mirrors* on page 2-14.

### Sensors

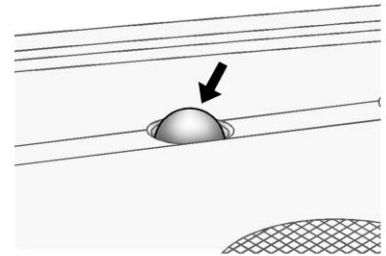

The solar sensor, located in the defrost grille in the middle of the instrument panel, monitors the solar heat. Do not cover the solar sensor or the system will not work properly.

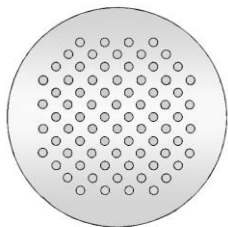

The interior temperature sensor, located in the headliner, measures the temperature of the air inside the vehicle.

There is also an exterior temperature sensor located behind the front grille. This sensor reads the outside air temperature and helps maintain the temperature inside the vehicle. Any cover on the front of the vehicle could cause a false reading in the displayed temperature.

The climate control system uses the information from these sensors to maintain comfort settings by adjusting the outlet temperature, fan speed, and the air delivery mode. The system may also supply cooler air to the side of the vehicle facing the sun. The recirculation mode will also be used as needed to maintain cool outlet temperatures.

### Air Vents

Use the air outlets located in the center and on the side of the instrument panel to direct the airflow. Use the thumbwheels near the air outlets to open or close off the airflow.

#### Operation Tips

- Clear away any ice, snow, or leaves from air inlets at the base of the windshield that could block the flow of air into the vehicle.
- Keep the path under the front seats clear of objects to help circulate the air inside of the vehicle more effectively.
- Use of non-GM approved hood deflectors can adversely affect the performance of the system. Check with your dealer before adding equipment to the outside of the vehicle.

## Driving and Operating

### Driving Information

Distracted Driving .....	9-2
Defensive Driving .....	9-3
Drunk Driving .....	9-3
Control of a Vehicle .....	9-3
Braking .....	9-3
Steering .....	9-4
Off-Road Recovery .....	9-4
Loss of Control .....	9-5
Off-Road Driving .....	9-5
Driving on Wet Roads .....	9-10
Highway Hypnosis .....	9-11
Hill and Mountain Roads .....	9-11
Winter Driving .....	9-12
If the Vehicle Is Stuck .....	9-14
Vehicle Load Limits .....	9-15
Truck-Camper Loading Information .....	9-21

### Starting and Operating

New Vehicle Break-In .....	9-23
Adjustable Throttle and Brake Pedal .....	9-23
Ignition Positions .....	9-24
Starting the Engine .....	9-25
Fast Idle System .....	9-27
Retained Accessory Power (RAP) .....	9-27
Engine Coolant Heater .....	9-28
Shifting Into Park .....	9-28
Shifting out of Park .....	9-30
Parking over Things That Burn .....	9-30
Active Fuel Management® .....	9-30

### Engine Exhaust

Engine Exhaust .....	9-31
Running the Vehicle While Parked .....	9-32

### Automatic Transmission

Automatic Transmission .....	9-32
Manual Mode .....	9-36
Tow/Haul Mode .....	9-37

### Drive Systems

Four-Wheel Drive .....	9-38
------------------------	------

### Brakes

Antilock Brake System (ABS) .....	9-50
Parking Brake .....	9-51
Brake Assist .....	9-52
Hill Start Assist (HSA) .....	9-52

### Ride Control Systems

StabiliTrak® System .....	9-53
Locking Rear Axle .....	9-55

### Cruise Control

Cruise Control .....	9-56
----------------------	------

### Object Detection Systems

Ultrasonic Parking Assist ....	9-59
Rear Vision Camera (RVC) .....	9-60

### Fuel

Fuel .....	9-65
Recommended Fuel .....	9-66
Gasoline Specifications .....	9-66
California Fuel Requirements .....	9-66

## 9-2 Driving and Operating

---

Fuels in Foreign Countries ...	9-66
Fuel Additives .....	9-67
Fuel E85 (85% Ethanol) .....	9-68
Filling the Tank .....	9-68
Filling a Portable Fuel Container .....	9-70

### Towing

General Towing Information .....	9-71
Driving Characteristics and Towing Tips .....	9-71
Trailer Towing .....	9-73
Towing Equipment .....	9-89
Trailer Sway Control (TSC) .....	9-100

### Conversions and Add-Ons

Add-On Electrical Equipment .....	9-101
Adding a Snow Plow or Similar Equipment .....	9-101
Pickup Conversion to Chassis Cab .....	9-104

## Driving Information

### Distracted Driving

Distraction comes in many forms and can take your focus from the task of driving. Exercise good judgment and do not let other activities divert your attention away from the road. Many local governments have enacted laws regarding driver distraction. Become familiar with the local laws in your area.

To avoid distracted driving, always keep your eyes on the road, hands on the wheel, and mind on the drive.

- Do not use a phone in demanding driving situations. Use a hands-free method to place or receive necessary phone calls.
- Watch the road. Do not read, take notes, or look up information on phones or other electronic devices.

- Designate a front seat passenger to handle potential distractions.
- Become familiar with vehicle features before driving, such as programming favorite radio stations and adjusting climate control and seat settings. Program all trip information into any navigation device prior to driving.
- Wait until the vehicle is parked to retrieve items that have fallen to the floor.
- Stop or park the vehicle to tend to children.
- Keep pets in an appropriate carrier or restraint.
- Avoid stressful conversations while driving, whether with a passenger or on a cell phone.

 **WARNING**

Taking your eyes off the road too long or too often could cause a crash resulting in injury or death. Focus your attention on driving.

Refer to the infotainment section for more information on using that system, including pairing and using a cell phone.

If equipped, refer to the navigation manual for information on that system, including pairing and using a cell phone.

### Defensive Driving

Defensive driving means “always expect the unexpected.” The first step in driving defensively is to wear the safety belt. See *Safety Belts on page 3-11*.

- Assume that other road users (pedestrians, bicyclists, and other drivers) are going to be

careless and make mistakes. Anticipate what they might do and be ready.

- Allow enough following distance between you and the driver in front of you.
- Focus on the task of driving.

### Drunk Driving

Death and injury associated with drinking and driving is a global tragedy.

 **WARNING**

Drinking and then driving is very dangerous. Your reflexes, perceptions, attentiveness, and judgment can be affected by even a small amount of alcohol. You can have a serious — or even fatal — collision if you drive after drinking.

(Continued)

**WARNING (Continued)**

Do not drink and drive or ride with a driver who has been drinking. Ride home in a cab; or if you are with a group, designate a driver who will not drink.

### Control of a Vehicle

Braking, steering, and accelerating are important factors in helping to control a vehicle while driving.

### Braking

Braking action involves perception time and reaction time. Deciding to push the brake pedal is perception time. Actually doing it is reaction time.

Average driver reaction time is about three-quarters of a second. In that time, a vehicle moving at 100 km/h (60 mph) travels 20 m (66 ft), which could be a lot of distance in an emergency.

## 9-4 Driving and Operating

---

Helpful braking tips to keep in mind include:

- Keep enough distance between you and the vehicle in front of you.
- Avoid needless heavy braking.
- Keep pace with traffic.

If the engine ever stops while the vehicle is being driven, brake normally but do not pump the brakes. Doing so could make the pedal harder to push down. If the engine stops, there will be some power brake assist but it will be used when the brake is applied. Once the power assist is used up, it can take longer to stop and the brake pedal will be harder to push.

### Steering

#### Hydraulic Power Steering

Your vehicle has hydraulic power steering. It may require maintenance. See *Power Steering Fluid* on page 10-23.

If power steering assist is lost because the engine stops or because of a system malfunction, the vehicle can be steered but may require increased effort. See your dealer if there is a problem.

If the vehicle is a hybrid, see the hybrid supplement for more information.

#### Curve Tips

- Take curves at a reasonable speed.
- Reduce speed before entering a curve.
- Maintain a reasonable steady speed through the curve
- Wait until the vehicle is out of the curve before accelerating gently into the straightaway.

#### Steering in Emergencies

- There are some situations when steering around a problem may be more effective than braking.
- Holding both sides of the steering wheel allows you to turn 180 degrees without removing a hand.
- Antilock Brake System (ABS) allows steering while braking.

#### Off-Road Recovery

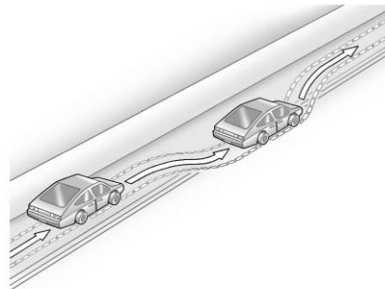

The vehicle's right wheels can drop off the edge of a road onto the shoulder while driving. Follow these tips:

1. Ease off the accelerator and then, if there is nothing in the way, steer the vehicle so that it straddles the edge of the pavement.
2. Turn the steering wheel about one-eighth of a turn, until the right front tire contacts the pavement edge.
3. Turn the steering wheel to go straight down the roadway.

## Loss of Control

### Skidding

There are three types of skids that correspond to the vehicle's three control systems:

- Braking Skid — wheels are not rolling.

- Steering or Cornering Skid — too much speed or steering in a curve causes tires to slip and lose cornering force.
- Acceleration Skid — too much throttle causes the driving wheels to spin.

Defensive drivers avoid most skids by taking reasonable care suited to existing conditions, and by not overdriving those conditions. But skids are always possible.

If the vehicle starts to slide, follow these suggestions:

- Ease your foot off the accelerator pedal and steer the way you want the vehicle to go. The vehicle may straighten out. Be ready for a second skid if it occurs.
- Slow down and adjust your driving according to weather conditions. Stopping distance can be longer and vehicle control can be affected when traction is reduced by water, snow, ice, gravel, or other

material on the road. Learn to recognize warning clues — such as enough water, ice, or packed snow on the road to make a mirrored surface — and slow down when you have any doubt.

- Try to avoid sudden steering, acceleration, or braking, including reducing vehicle speed by shifting to a lower gear. Any sudden changes could cause the tires to slide.

Remember: Antilock brakes help avoid only the braking skid.

### Off-Road Driving

Four-wheel-drive vehicles can be used for off-road driving. Vehicles without four-wheel drive and vehicles not equipped with All Terrain (AT) or On-Off Road (OOR) tires must not be driven off-road except on a level, solid surface. To contact the tire manufacturer for more information about the original

## 9-6 Driving and Operating

equipment tires, see the Limited Warranty and Owner Assistance Information manual.

Controlling the vehicle is the key to successful off-road driving. One of the best ways to control the vehicle is to control the speed.

### WARNING

When driving off-road, bouncing and quick changes in direction can easily throw you out of position. This could cause you to lose control and crash. You and your passengers should always wear safety belts.

### Before Driving Off-Road

- Have all necessary maintenance and service work completed.
- Fuel the vehicle, fill fluid levels, and check inflation pressure in all tires, including the spare, if equipped.

- Read all the information about four-wheel-drive vehicles in this manual.
- Make sure all underbody shields, if equipped, are properly attached.
- Know the local laws that apply to off-road driving.

To gain more ground clearance if needed, it may be necessary to remove the front fascia lower air dam.

**Notice: Operating the vehicle for extended periods without the front fascia lower air dam installed can cause improper air flow to the engine. Re-attach the front fascia air dam after off-road driving.**

### Loading the Vehicle for Off-Road Driving

#### WARNING

- Unsecured cargo on the load floor can be tossed about when driving over rough terrain. You or your passengers can be struck by flying objects. Secure the cargo properly.
- Keep cargo in the cargo area as far forward and as low as possible. The heaviest things should be on the floor, forward of the rear axle.
- Heavy loads on the roof raise the vehicle's center of gravity, making it more likely to roll over. You can be seriously or fatally injured if the vehicle rolls over. Put heavy loads inside the cargo area, not on the roof.



For more information about loading the vehicle, see Vehicle Load Limits and Tires.

### Environmental Concerns

- Always use established trails, roads, and areas that have been set aside for public off-road recreational driving and obey all posted regulations.
- Do not damage shrubs, flowers, trees, or grasses or disturb wildlife.
- Do not park over things that burn. See *Parking over Things That Burn* on page 9-30.

### Driving on Hills

Driving safely on hills requires good judgment and an understanding of what the vehicle can and cannot do.

#### WARNING

Many hills are simply too steep for any vehicle. Driving up hills can cause the vehicle to stall. Driving down hills can cause loss of control. Driving across hills can cause a rollover. You could be injured or killed. Do not drive on steep hills.

Before driving on a hill, assess the steepness, traction, and obstructions. If the terrain ahead cannot be seen, get out of the vehicle and walk the hill before driving further.

When driving on hills:

- Use a low gear and keep a firm grip on the steering wheel.
- Maintain a slow speed.
- When possible, drive straight up or down the hill.

- Slow down when approaching the top of the hill.
- Use headlamps even during the day to make the vehicle more visible.

#### WARNING

Driving to the top of a hill at high speed can cause an accident. There could be a drop-off, embankment, cliff, or even another vehicle. You could be seriously injured or killed. As you near the top of a hill, slow down and stay alert.

- Never go downhill forward or backward with either the transmission or transfer case in N (Neutral). The brakes could overheat and you could lose control.

## 9-8 Driving and Operating

### WARNING

If the vehicle has the two-speed automatic transfer case, shifting the transfer case to N (Neutral) can cause your vehicle to roll even if the transmission is in P (Park). This is because the N (Neutral) position on the transfer case overrides the transmission. You or someone else could be injured. If leaving the vehicle, set the parking brake and shift the transmission to P (Park). Shift the transfer case to any position but N (Neutral).

- When driving down a hill, keep the vehicle headed straight down. Use a low gear because the engine will work with the brakes to slow the vehicle and help keep the vehicle under control.

### WARNING

Heavy braking when going down a hill can cause your brakes to overheat and fade. This could cause loss of control and you or others could be injured or killed. Apply the brakes lightly when descending a hill and use a low gear to keep vehicle speed under control.

If the vehicle stalls on a hill:

1. Apply the brakes to stop the vehicle, and then apply the parking brake.
2. Shift into P (Park) and then restart the engine.
  - If driving uphill when the vehicle stalls, shift to R (Reverse), release the parking brake, and back straight down.

- Never try to turn the vehicle around. If the hill is steep enough to stall the vehicle, it is steep enough to cause it to roll over.
  - If you cannot make it up the hill, back straight down the hill.
  - Never back down a hill in N (Neutral) using only the brake.
  - The vehicle can roll backward quickly and you could lose control.
  - If driving downhill when the vehicle stalls, shift to a lower gear, release the parking brake, and drive straight down the hill.
3. If the vehicle cannot be restarted after stalling, set the parking brake, shift an automatic transmission into P (Park), and turn the vehicle off.
    - 3.1. Leave the vehicle and seek help.

- 3.2. Stay clear of the path the vehicle would take if it rolled downhill.
- Avoid turns that take the vehicle across the incline of the hill. A hill that can be driven straight up or down might be too steep to drive across. Driving across an incline puts more weight on the downhill wheels which could cause a downhill slide or a rollover.
  - Surface conditions can be a problem. Loose gravel, muddy spots, or even wet grass can cause the tires to slip sideways, downhill. If the vehicle slips sideways, it can hit something that will trip it – a rock, a rut, etc. – and roll over.
  - Hidden obstacles can make the steepness of the incline more severe. If a rock is driven across with the uphill wheels, or if the downhill wheels drop into a rut or depression, the vehicle can tilt even more.

- If an incline must be driven across, and the vehicle starts to slide, turn downhill. This should help straighten out the vehicle and prevent the side slipping.

 **WARNING**

Getting out of the vehicle on the downhill side when stopped across an incline is dangerous. If the vehicle rolls over, you could be crushed or killed. Always get out on the uphill side of the vehicle and stay well clear of the rollover path.

**Driving in Mud, Sand, Snow, or Ice**

Use a low gear when driving in mud – the deeper the mud, the lower the gear. Keep the vehicle moving to avoid getting stuck.

Traction changes when driving on sand. On loose sand, such as on beaches or sand dunes, the tires tend to sink into the sand. This affects steering, accelerating, and braking. Drive at a reduced speed and avoid sharp turns or abrupt maneuvers.

Traction is reduced on hard packed snow and ice and it is easy to lose control. Reduce vehicle speed when driving on hard packed snow and ice.

 **WARNING**

Driving on frozen lakes, ponds, or rivers can be dangerous. Ice conditions vary greatly and the vehicle could fall through the ice; you and your passengers could drown. Drive your vehicle on safe surfaces only.

### Driving in Water

#### WARNING

Driving through rushing water can be dangerous. Deep water can sweep your vehicle downstream and you and your passengers could drown. If it is only shallow water, it can still wash away the ground from under your tires. Traction could be lost, and the vehicle could roll over. Do not drive through rushing water.

**Notice:** Do not drive through standing water if it is deep enough to cover the wheel hubs, axles or exhaust pipe. Deep water can damage the axle and other vehicle parts.

If the standing water is not too deep, drive slowly through it. At faster speeds, water splashes on the ignition system and the vehicle can stall. Stalling can also occur if you get the tailpipe under water. While

the tailpipe is under water, you will not be able to start the engine. When going through water, the brakes get wet, and it might take longer to stop. See Driving on Wet Roads.

### After Off-Road Driving

Remove any brush or debris that has collected on the underbody, or chassis, or under the hood. These accumulations can be a fire hazard.

After operation in mud or sand, have the brake linings cleaned and checked. These substances can cause glazing and uneven braking. Check the body structure, steering, suspension, wheels, tires, and exhaust system for damage and check the fuel lines and cooling system for any leakage.

More frequent maintenance service is required. Refer to the Maintenance Schedule for more information.

### Driving on Wet Roads

Rain and wet roads can reduce vehicle traction and affect your ability to stop and accelerate. Always drive slower in these types of driving conditions and avoid driving through large puddles and deep-standing or flowing water.

#### WARNING

Wet brakes can cause crashes. They might not work as well in a quick stop and could cause pulling to one side. You could lose control of the vehicle.

After driving through a large puddle of water or a car/vehicle wash, lightly apply the brake pedal until the brakes work normally.

Flowing or rushing water creates strong forces. Driving through flowing water could cause the vehicle to be carried away. If this

(Continued)

**WARNING (Continued)**

happens, you and other vehicle occupants could drown. Do not ignore police warnings and be very cautious about trying to drive through flowing water.

**Hydroplaning**

Hydroplaning is dangerous. Water can build up under the vehicle's tires so they actually ride on the water. This can happen if the road is wet enough and you are going fast enough. When the vehicle is hydroplaning, it has little or no contact with the road.

There is no hard and fast rule about hydroplaning. The best advice is to slow down when the road is wet.

**Other Rainy Weather Tips**

Besides slowing down, other wet weather driving tips include:

- Allow extra following distance.

- Pass with caution.
- Keep windshield wiping equipment in good shape.
- Keep the windshield washer fluid reservoir filled.
- Have good tires with proper tread depth. See *Tires on page 10-46*.
- Turn off cruise control.

**Highway Hypnosis**

Always be alert and pay attention to your surroundings while driving. If you become tired or sleepy, find a safe place to park the vehicle and rest.

Other driving tips include:

- Keep the vehicle well ventilated.
- Keep the interior temperature cool.
- Keep your eyes moving — scan the road ahead and to the sides.
- Check the rearview mirror and vehicle instruments often.

**Hill and Mountain Roads**

Driving on steep hills or through mountains is different than driving on flat or rolling terrain. Tips for driving in these conditions include:

- Keep the vehicle serviced and in good shape.
- Check all fluid levels and brakes, tires, cooling system, and transmission.
- Shift to a lower gear when going down steep or long hills.

** WARNING**

If you do not shift down, the brakes could get so hot that they would not work well. You would then have poor braking or even none going down a hill. You could crash. Shift down to let the engine assist the brakes on a steep downhill slope.

### WARNING

Coasting downhill in N (Neutral) or with the ignition off is dangerous. The brakes will have to do all the work of slowing down and they could get so hot that they would not work well. You would then have poor braking or even none going down a hill. Steering may also be affected when ignition is off. You could crash. Always have the engine running and the vehicle in gear when going downhill.

- Stay in your own lane. Do not swing wide or cut across the center of the road. Drive at speeds that let you stay in your own lane.
- Be alert on top of hills; something could be in your lane (stalled car, accident).

- Pay attention to special road signs (falling rocks area, winding roads, long grades, passing or no-passing zones) and take appropriate action.

## Winter Driving

### Driving on Snow or Ice

Drive carefully when there is snow or ice between the tires and the road, creating less traction or grip. Wet ice can occur at about 0°C (32°F) when freezing rain begins to fall, resulting in even less traction. Avoid driving on wet ice or in freezing rain until roads can be treated with salt or sand.

Drive with caution, whatever the condition. Accelerate gently so traction is not lost. Accelerating too quickly causes the wheels to spin and makes the surface under the tires slick, so there is even less traction.

Try not to break the fragile traction. If you accelerate too fast, the drive wheels will spin and polish the surface under the tires even more.

The Antilock Brake System (ABS) improves vehicle stability during hard stops on slippery roads, but apply the brakes sooner than when on dry pavement. See *Antilock Brake System (ABS)* on page 9-50.

Allow greater following distance on any slippery road and watch for slippery spots. Icy patches can occur on otherwise clear roads in shaded areas. The surface of a curve or an overpass can remain icy when the surrounding roads are clear. Avoid sudden steering maneuvers and braking while on ice.

Turn off cruise control on slippery surfaces.

## Blizzard Conditions

Being stuck in snow can be a serious situation. Stay with the vehicle unless there is help nearby. If possible, use Roadside Assistance. See *Roadside Assistance Program (Mexico)* on page 13-7 or *Roadside Assistance Program (U.S. and Canada)* on page 13-11. To get help and keep everyone in the vehicle safe:

- Turn on the hazard warning flashers.
- Tie a red cloth to an outside mirror.

### WARNING

Snow can trap engine exhaust under the vehicle. This may cause exhaust gases to get inside. Engine exhaust contains carbon monoxide (CO) which

(Continued)

### WARNING (Continued)

cannot be seen or smelled. It can cause unconsciousness and even death.

If the vehicle is stuck in the snow:

- Clear away snow from around the base of your vehicle, especially any that is blocking the exhaust pipe.
- Check again from time to time to be sure snow does not collect there.
- Open a window about 5 cm (2 in) on the side of the vehicle that is away from the wind to bring in fresh air.
- Fully open the air outlets on or under the instrument panel.
- Adjust the climate control system to a setting that circulates the air inside the vehicle and set the fan speed

(Continued)

### WARNING (Continued)

to the highest setting. See “Climate Control Systems” in the Index.

For more information about carbon monoxide, see *Engine Exhaust* on page 9-31.

To save fuel, run the engine for only short periods as needed to warm the vehicle and then shut the engine off and close the window most of the way to save heat. Repeat this until help arrives but only when you feel really uncomfortable from the cold. Moving about to keep warm also helps.

If it takes some time for help to arrive, now and then when you run the engine, push the accelerator pedal slightly so the engine runs faster than the idle speed. This keeps the battery charged to restart the vehicle and to signal for help with the headlamps. Do this as little as possible to save fuel.

### If the Vehicle Is Stuck

Slowly and cautiously spin the wheels to free the vehicle when stuck in sand, mud, ice, or snow. See "Rocking Your Vehicle to Get It Out" later in this section.

If the vehicle has a traction system, it can often help to free a stuck vehicle. Refer to the vehicle's traction system in the Index. If stuck too severely for the traction system to free the vehicle, turn the traction system off and use the rocking method.

#### WARNING

If the vehicle's tires spin at high speed, they can explode, and you or others could be injured. The vehicle can overheat, causing an engine compartment fire or other damage. Spin the wheels as little as possible and avoid going above 56 km/h (35 mph).

For information about using tire chains on the vehicle, see *Tire Chains* on page 10-70.

### Rocking Your Vehicle to Get It Out

Turn the steering wheel left and right to clear the area around the front wheels. For four-wheel-drive vehicles, shift into Four-Wheel High. For vehicles with StabiliTrak<sup>®</sup>, turn the traction control part of the system off. Shift back and forth between R (Reverse) and a forward gear, spinning the wheels as little as possible. To prevent transmission wear, wait until the wheels stop spinning before shifting gears. Release the accelerator pedal while shifting, and press lightly on the accelerator pedal when the transmission is in gear. Slowly

spinning the wheels in the forward and reverse directions causes a rocking motion that could free the vehicle. If that does not get the vehicle out after a few tries, it might need to be towed out. Recovery hooks can be used, if the vehicle has them. If the vehicle does need to be towed out, see *Towing the Vehicle* on page 10-87.

### Recovery Hooks

#### WARNING

Never pull on recovery hooks from the side. The hooks could break and you and others could be injured. When using recovery hooks, always pull the vehicle from the front.



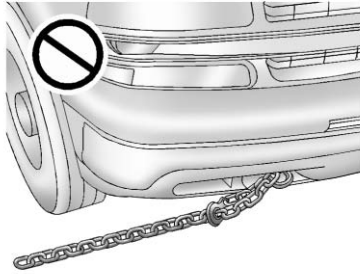

**Notice:** Never use recovery hooks to tow the vehicle. Your vehicle could be damaged and it would not be covered by warranty.

For vehicles with recovery hooks at the front of the vehicle, you can use them if you are stuck off-road and need to be pulled to some place where you can continue driving.

### Vehicle Load Limits

It is very important to know how much weight your vehicle can carry. This weight is called the

vehicle capacity weight and includes the weight of all occupants, cargo, and all nonfactory-installed options. Two labels on your vehicle show how much weight it was designed to carry, the Tire and Loading Information label and the Certification/Tire label.

**⚠ WARNING**

Do not load the vehicle any heavier than the Gross Vehicle Weight Rating (GVWR), or either the maximum front or rear Gross Axle Weight Rating (GAWR). This can cause systems to break and change the way the vehicle handles. This could cause loss of control and a crash. Overloading can also shorten the life of the vehicle.

### Tire and Loading Information Label

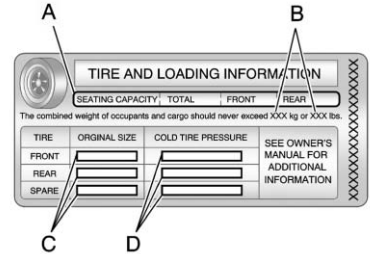

#### Label Example

A vehicle specific Tire and Loading Information label is attached to the center pillar (B-pillar). With the driver door open, you will find the label attached below the door lock post (striker). The tire and loading information label shows the number of occupant seating

## 9-16 Driving and Operating

---

positions (A), and the maximum vehicle capacity weight (B) in kilograms and pounds.

The Tire and Loading Information label also shows the size of the original equipment tires (C) and the recommended cold tire inflation pressures (D). For more information on tires and inflation see *Tires on page 10-46* and *Tire Pressure on page 10-55*.

There is also important loading information on the vehicle Certification/Tire label. It tells you the Gross Vehicle Weight Rating (GVWR) and the Gross Axle Weight Rating (GAWR) for the front and rear axles. See "Certification/Tire Label" later in this section.

### Steps for Determining Correct Load Limit

1. Locate the statement "The combined weight of occupants and cargo should never exceed XXX kg or XXX lbs" on your vehicle's placard.
2. Determine the combined weight of the driver and passengers that will be riding in your vehicle.
3. Subtract the combined weight of the driver and passengers from XXX kg or XXX lbs.
4. The resulting figure equals the available amount of cargo and luggage load capacity. For example, if the "XXX" amount equals 1400 lbs and there will be five 150 lb passengers in your vehicle, the amount of available cargo

and luggage load capacity is 650 lbs (1400-750 (5x150) = 650 lbs).

5. Determine the combined weight of luggage and cargo being loaded on the vehicle. That weight may not safely exceed the available cargo and luggage load capacity calculated in Step 4.
6. If your vehicle will be towing a trailer, the load from your trailer will be transferred to your vehicle. Consult this manual to determine how this reduces the available cargo and luggage load capacity of your vehicle. See *Trailer Towing on page 9-73* for important information on towing a trailer, towing safety rules and trailering tips.



**Example 1**

- A. Vehicle Capacity Weight for Example 1 = (453 kg) (1,000 lbs)
- B. Subtract Occupant Weight @ 68 kg (150 lbs) × 2 = 136 kg (300 lbs)
- C. Available Occupant and Cargo Weight = 317 kg (700 lbs)

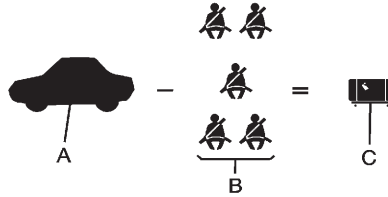

**Example 2**

- A. Vehicle Capacity Weight for Example 2 = 453 kg (1,000 lbs)
- B. Subtract Occupant Weight @ 68 kg (150 lbs) × 5 = 340 kg (750 lbs)
- C. Available Cargo Weight = 113 kg (250 lbs)

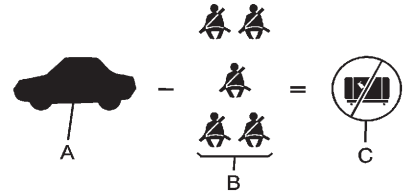

**Example 3**

- A. Vehicle Capacity Weight for Example 3 = 453 kg (1,000 lbs)
- B. Subtract Occupant Weight @ 91 kg (200 lbs) × 5 = 453 kg (1,000 lbs)
- C. Available Cargo Weight = 0 kg (0 lbs)

Refer to your vehicle's tire and loading information label for specific information about your vehicle's capacity weight and seating positions. The combined

## 9-18 Driving and Operating

weight of the driver, passengers, and cargo should never exceed your vehicle's capacity weight.

### Certification/Tire Label

GVWR	GAWR FRT	GAWR RR	
MODEL:	PAYLOAD =		
TIRE SIZE	SPEED	RIM	COLD TIRE PRESSURE
FRT			
RR			
SPA			
SEE OWNER'S MANUAL FOR ADDITIONAL INFORMATION			

A vehicle specific Certification/Tire label is found on the rear edge of the driver door. The label shows the size of your vehicle's original tires and the inflation pressures needed to obtain the gross weight capacity of your vehicle. This is called Gross Vehicle Weight

Rating (GVWR). The GVWR includes the weight of the vehicle, all occupants, fuel, and cargo.

The Certification/Tire label also tells you the maximum weights for the front and rear axles, called Gross Axle Weight Rating (GAWR). To find out the actual loads on your front and rear axles, you need to go to a weigh station and weigh your vehicle. Your dealer can help you with this. Be sure to spread out your load equally on both sides of the centerline.

Never exceed the GVWR for your vehicle, or the GAWR for either the front or rear axle.

The Certification/Tire label also contains important information about your Front Axle Reserve Capacity. See "What is front axle reserve capacity, and how do I

calculate it?" under *Adding a Snow Plow or Similar Equipment* on page 9-101.

### WARNING

In the case of a sudden stop or collision, things carried in the bed of your truck could shift forward and come into the passenger area, injuring you and others. If you put things in the bed of your truck, you should make sure they are properly secured.

### WARNING

Do not load the vehicle any heavier than the Gross Vehicle Weight Rating (GVWR), or either the maximum front or rear Gross

(Continued)

**WARNING (Continued)**

Axle Weight Rating (GAWR). This can cause systems to break and change the way the vehicle handles. This could cause loss of control and a crash. Overloading can also shorten the life of the vehicle.

**Notice: Overloading the vehicle may cause damage. Repairs would not be covered by the vehicle warranty. Do not overload the vehicle.**

Using heavier suspension components to get added durability might not change your weight ratings. Ask your dealer to help you load your vehicle the right way.

If you put things inside your vehicle — like suitcases, tools, packages, or anything

else — they go as fast as the vehicle goes. If you have to stop or turn quickly, or if there is a crash, they will keep going.

**⚠ WARNING**

Things you put inside the vehicle can strike and injure people in a sudden stop or turn, or in a crash.

- Put things in the cargo area of the vehicle. Try to spread the weight evenly.
- Never stack heavier things, like suitcases, inside the vehicle so that some of them are above the tops of the seats.
- Do not leave an unsecured child restraint in the vehicle.

(Continued)

**WARNING (Continued)**

- When you carry something inside the vehicle, secure it whenever you can.
- Do not leave a seat folded down unless you need to.

There is also important loading information for off-road driving in this manual. See “Loading Your Vehicle for Off-Road Driving” under *Off-Road Driving* on page 9-5.

**Two-Tiered Loading**

Depending on the model of your pick-up, an upper load platform can be created by positioning three or four 5 cm (2 inches) by 15 cm (6 inches) wooden planks across the width of the pickup box. The planks must be inserted in the pickup box depressions.

## 9-20 Driving and Operating

When using this upper load platform, be sure the load is securely tied down to prevent it from shifting. The load's center of gravity should be positioned in a zone over the rear axle. The zone is located in the area between the front of each wheel well and the rear of each wheel well. The center of gravity height must not extend above the top of the pickup box flareboard.

Any load that extends beyond the vehicle's taillamp area must be properly marked according to local laws and regulations.

Remember not to exceed the Gross Axle Weight Rating (GAWR) of the front or rear axle.

### Add-On Equipment

When you carry removable items, you may need to put a limit on how many people you

carry inside your vehicle. Be sure to weigh your vehicle before you buy and install the new equipment.

**Notice: Overloading the vehicle may cause damage. Repairs would not be covered by the vehicle warranty. Do not overload the vehicle.**

Remember not to exceed the Gross Axle Weight Rating (GAWR) of the front or rear axle.

* Equipment	Maximum Weight
Ladder Rack and Cargo	340 kg (750 lbs)
Cross Toolbox and Cargo	181 kg (400 lbs)
Side Boxes and Cargo	113 kg per side (250 lbs per side)

* Equipment	Maximum Weight
* The combined weight for all rail-mounted equipment should not exceed 454 kg (1,000 lbs).	

### Loading Points

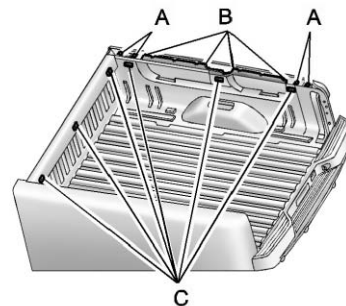

- A. Primary Load Points
- B. Secondary Load Areas
- C. Cargo Management Option Holes

Structural members (A) and (B) are included in the pick-up box design. Additional accessories should use these load points. Depending on the accessory design, use a spacer under the accessory at the load points to remove gap. The holes for the Cargo Management System (C) are not intended for attachment of aftermarket equipment. See [www.gmupfitter.com](http://www.gmupfitter.com) for additional pick-up box load bearing structural information.

## Truck-Camper Loading Information

A vehicle-specific Truck-Camper Loading Information label is attached to the inside of the vehicle's glove box. This label indicates if a slide-in camper can be carried, how much of a load the vehicle can carry, and how to correctly spread out the load. It will help to match the right slide in camper to the vehicle.

Your dealer can help make a good vehicle-camper match and help determine the Cargo Weight Rating (CWR).

When installing and loading a slide-in camper, check the manufacturer's instructions.

When carrying a slide-in camper, the total cargo load of the vehicle is the weight of the camper, plus the following:

- Everything added to the camper after it left the factory
- Everything in the camper
- All the people inside

The CWR is the maximum weight of the load the vehicle can carry. It does not include the weight of the people inside. But, use about 68 kg (150 lbs) for each seat.

The total cargo load must not be more than the vehicle's CWR.

Refer to the Truck-Camper Loading Information label in the glove box for dimensions A and B as shown in the following illustration.

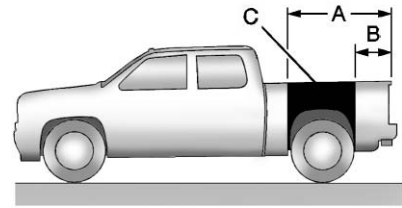

Use the rear edge of the load floor for measurement purposes. The recommended location for the cargo center of gravity is at point C for the CWR. It is the point where the mass of a body is concentrated and, if suspended at that point, would balance the front and rear.

## 9-22 Driving and Operating

Here is an example of proper truck and camper match:

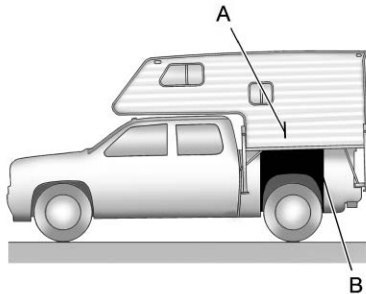

- A. Camper Center of Gravity
- B. Recommended Center of Gravity Location Zone

When the truck is used to carry a slide-in camper, the total cargo load of the truck consists of the manufacturer's camper weight figure, the weight of installed additional camper equipment not included in the manufacturer's camper weight figure, the weight

of camper cargo, and the weight of passengers in the camper. The total cargo load should not exceed the truck's cargo weight rating, and the camper's center of gravity (A) should fall within the truck's recommended center of gravity zone (B) when installed.

Any accessories or other equipment that are added to the vehicle must be weighed. Then, subtract this extra weight from the CWR. This extra weight may shorten the center of gravity zone of the vehicle.

If the slide-in camper and its load weighs less than the CWR, the center of gravity zone for your vehicle may be larger.

Secure loose items to prevent weight shifts that could affect the balance of the vehicle. When the truck-camper is loaded, drive to a scale and weigh on the front

and on the rear wheels separately to determine axle loads. Individual axle loads should not exceed either of the gross axle weight ratings (GAWR). The total axle loads should not exceed your vehicle's gross vehicle weight rating (GVWR). These ratings are given on the vehicle certification label attached to the rear edge of the driver door. See "Certification/Tire Label" under *Vehicle Load Limits* on page 9-15. If weight ratings are exceeded, move or remove items to bring all weights below the ratings.

See your dealer for more information on curb weights, cargo weights, Cargo Weight Rating and the correct center of gravity zone.



## Starting and Operating

### New Vehicle Break-In

**Notice:** The vehicle does not need an elaborate break-in. But it will perform better in the long run if you follow these guidelines:

- Keep the vehicle speed at 88 km/h (55 mph) or less for the first 805 km (500 miles).
- Do not drive at any one constant speed, fast or slow, for the first 805 km (500 miles). Do not make full-throttle starts. Avoid downshifting to brake or slow the vehicle.
- Avoid making hard stops for the first 322 km (200 miles) or so. During this time the new brake linings are not yet broken in. Hard stops with new linings can mean premature wear and earlier replacement. Follow this

breaking-in guideline every time you get new brake linings.

- Do not tow a trailer during break-in. See *Trailer Towing on page 9-73* for the trailer towing capabilities of the vehicle and more information.

Following break-in, engine speed and load can be gradually increased.

### Adjustable Throttle and Brake Pedal

On vehicles with this feature, you can change the position of the throttle and brake pedals.

No adjustment to the pedals can be made when the vehicle is in R (Reverse) or while using cruise control.



The control used to adjust the pedals is located on the instrument panel below the climate control system.

Press the bottom of the control to move the pedals closer. Press the top of the control to move the pedals away.

Before you start driving, fully press the brake pedal to confirm the adjustment is right for you. While driving, make only small adjustments.

The vehicle may have a memory function which lets pedal settings be saved and recalled. See *Memory Seats on page 3-6*.

### Ignition Positions

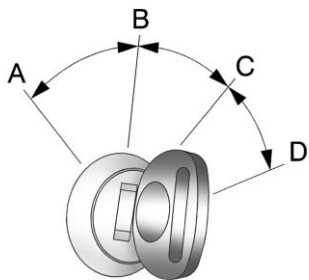

The ignition switch has four different positions.

To shift out of P (Park), the ignition must be in ON/RUN or ACC/ACCESSORY and the regular brake pedal must be applied.

**A (STOPPING THE ENGINE/ LOCK/OFF):** When the vehicle is stopped, turn the ignition switch to LOCK/OFF to turn the engine off. Retained Accessory Power (RAP) will remain active. See *Retained Accessory Power (RAP)* on page 9-27.

This position locks the ignition. It also locks the transmission on automatic transmission vehicles. The key can be removed in LOCK/OFF.

The steering can bind with the wheels turned off center. If this happens, move the steering wheel from right to left while turning the key to ACC/ACCESSORY. If this does not work, then the vehicle needs service.

Do not turn the engine off when the vehicle is moving. This will cause a loss of power assist in the brake and steering systems and disable the airbags.

If the vehicle must be shut off in an emergency:

1. Brake using a firm and steady pressure. Do not pump the brakes repeatedly. This may deplete power assist, requiring increased brake pedal force.
2. Shift the vehicle to N (Neutral). This can be done while the vehicle is moving. After shifting to N (Neutral), firmly apply the brakes and steer the vehicle to a safe location.
3. Come to a complete stop, shift to P (Park), and turn the ignition to LOCK/OFF. On vehicles with an automatic transmission, the shift lever must be in P (Park) to turn the ignition switch to the LOCK/OFF position.
4. Set the parking brake. See *Parking Brake* on page 9-51.

 **WARNING**

Turning off the vehicle while moving may cause loss of power assist in the brake and steering systems and disable the airbags. While driving, only shut the vehicle off in an emergency.

If the vehicle cannot be pulled over, and must be shut off while driving, turn the ignition to ACC/ACCESSORY.

**Notice:** Using a tool to force the key to turn in the ignition could cause damage to the switch or break the key. Use the correct key, make sure it is all the way in, and turn it only with your hand. If the key cannot be turned by hand, see your dealer.

**B (ACC/ACCESSORY):** This position lets things like the radio and the windshield wipers operate

while the engine is off. Use this position if the vehicle must be pushed or towed.

**C (ON/RUN):** This position can be used to operate the electrical accessories and to display some instrument panel cluster warning and indicator lights. This position can also be used for service and diagnostics, and to verify the proper operation of the malfunction indicator lamp as may be required for emission inspection purposes. The switch stays in this position when the engine is running. The transmission is also unlocked in this position on automatic transmission vehicles.

If you leave the key in the ACC/ACCESSORY or ON/RUN position with the engine off, the battery could be drained. You may not be able to start the vehicle if the battery is allowed to drain for an extended period of time.

**D (START):** This is the position that starts the engine. When the engine starts, release the key. The ignition switch returns to ON/RUN for driving.

A warning tone will sound when the driver door is opened and the ignition is in ACC/ACCESSORY or LOCK/OFF, and the key is in the ignition.

## Starting the Engine

If the vehicle has a diesel engine, see the Duramax<sup>®</sup> diesel supplement for more information.

If the vehicle is a hybrid, see the hybrid supplement for more information.

**Notice:** Do not try to shift to P (Park) if the vehicle is moving. If you do, you could damage the transmission. Shift to P (Park) only when the vehicle is stopped.

Move the shift lever to P (Park) or N (Neutral). The engine will not start in any other position. To restart the engine when the vehicle is already moving, use N (Neutral) only.

**Notice:** If you add electrical parts or accessories, you could change the way the engine operates. Any resulting damage would not be covered by the vehicle warranty. See *Add-On Electrical Equipment* on page 9-101.

### Starting Procedure

1. With your foot off the accelerator pedal, turn the ignition key to START. When the engine starts, let go of the key. The idle speed will go down as your engine gets warm. Do not race the engine immediately after starting it. Operate the engine and transmission gently to allow the oil to warm up and lubricate all moving parts.

The vehicle has a Computer-Controlled Cranking System. This feature assists in starting the engine and protects components. If the ignition key is turned to the START position, and then released when the engine begins cranking, the engine will continue cranking for a few seconds or until the vehicle starts. If the engine does not start and the key is held in START for many seconds, cranking will be stopped after 15 seconds to prevent cranking motor damage. To prevent gear damage, this system also prevents cranking if the engine is already running. Engine cranking can be stopped by turning the ignition switch to the ACC/ACCESSORY or LOCK/OFF position.

When the Low Fuel warning lamp is on and the FUEL LEVEL LOW message is displayed in the Driver Information Center (DIC), the Computer-Controlled

Cranking System is disabled to prevent possible vehicle component damage. When this happens, hold the ignition switch in the START position to continue engine cranking.

**Notice:** Cranking the engine for long periods of time, by returning the key to the START position immediately after cranking has ended, can overheat and damage the cranking motor, and drain the battery. Wait at least 15 seconds between each try, to let the cranking motor cool down.

2. If the engine does not start after 5-10 seconds, especially in very cold weather (below  $-18^{\circ}\text{C}$  or  $0^{\circ}\text{F}$ ), it could be flooded with too much gasoline. Try pushing the accelerator pedal all the way to the floor and holding it there as you hold the key in START for up to 15 seconds. Wait at least 15 seconds between each try, to allow the cranking motor to cool down. When the engine starts, let go of the key and accelerator.

If the vehicle starts briefly but then stops again, do the same thing. This clears the extra gasoline from the engine. Do not race the engine immediately after starting it. Operate the engine and transmission gently until the oil warms up and lubricates all moving parts.

## Fast Idle System

If the vehicle has this feature it is available only with cruise control. The manual fast idle switch is operated using the cruise control buttons located on the left hand side of the steering wheel.

This system can be used to increase engine idle speed whenever the following conditions are met:

- The parking brake is set.
- The brake pedal is not pressed.
- The vehicle must not be moving and the accelerator must not be pressed.

To control the fast idle:

- To enable the Fast Idle System, press and release the cruise control on/off button and ensure that the switch indicator light is lit.
- Press and release the cruise control SET-button. Engine speed will be held at approximately 1200 RPM.

When the fast idle is active the Driver Information Center (DIC) will display "FAST IDLE ON."

One of the following actions will turn off the fast idle:

- Pressing the brake.
- Selecting the cruise control cancel button.
- Releasing the parking brake.
- The transmission shift lever is moved out of P (Park) or N (Neutral).
- Selecting the cruise control on/off button when it was previously on.

- Pressing the cruise control SET-button a second time.
- Pressing the accelerator greater than a quarter of the way down.
- Turning the ignition switch to the LOCK/OFF position.

## Retained Accessory Power (RAP)

The following vehicle accessories can be used for up to 10 minutes after the engine is turned off:

- Audio System
- Power Windows
- OnStar System (if equipped)
- Sunroof (if equipped)

These features work when the key is in ON/RUN or ACC/ACCESSORY. Once the key is turned from ON/RUN to LOCK/OFF, the windows and sunroof continue to work up to 10 minutes until any door is opened. The radio continues to work for up to 10 minutes or until the driver door is opened.

### Engine Coolant Heater

The engine heater can provide easier starting and better fuel economy during engine warm-up in cold weather conditions at or below  $-18^{\circ}\text{C}$  ( $0^{\circ}\text{F}$ ). Vehicles with an engine heater should be plugged in at least four hours before starting. An internal thermostat in the plug-end of the cord may exist which will prevent engine coolant heater operation at temperatures above  $-18^{\circ}\text{C}$  ( $0^{\circ}\text{F}$ ).

If the vehicle has a diesel engine, see the Duramax Diesel supplement for more information.

#### To Use the Engine Coolant Heater

1. Turn off the engine.
2. Open the hood and unwrap the electrical cord. The cord is secured to the Engine Compartment Fuse Block with a clip. Carefully remove the wire

tie which bundles the electrical plug. Do not cut the electrical cord.

3. Plug the cord into a normal, grounded 110-volt AC outlet.

#### WARNING

Plugging the cord into an ungrounded outlet could cause an electrical shock. Also, the wrong kind of extension cord could overheat and cause a fire. You could be seriously injured. Plug the cord into a properly grounded three-prong 110-volt AC outlet. If the cord will not reach, use a heavy-duty three-prong extension cord rated for at least 15 amps.

4. Before starting the engine, be sure to unplug and store the cord as it was before to keep it away from moving engine parts. If you do not, it could be damaged.

The length of time the heater should remain plugged in depends on several factors. Ask a dealer in the area where you will be parking the vehicle for the best advice on this.

### Shifting Into Park

#### WARNING

It can be dangerous to get out of the vehicle if the shift lever is not fully in P (Park) with the parking brake firmly set. The vehicle can roll. If you have left the engine running, the vehicle can move suddenly. You or others could be injured. To be sure the vehicle will not move, even when you are on fairly level ground, use the steps that follow. With four-wheel drive, if the transfer case is in N (Neutral), the vehicle will be free to roll, even if the shift lever is in P (Park). Be sure the transfer

(Continued)

**WARNING (Continued)**

case is in a drive gear. If towing a trailer, see *Driving Characteristics and Towing Tips* on page 9-71.

1. Hold the brake pedal down, then set the parking brake.  
See *Parking Brake* on page 9-51 for more information.
2. Move the shift lever into the P (Park) position by pulling the shift lever toward you and moving it up as far as it will go.
3. Be sure the transfer case is in a drive gear — not in N (Neutral).
4. Turn the ignition key to LOCK/OFF.
5. Remove the key and take it with you. If you can leave the vehicle with the ignition key in your hand, the vehicle is in P (Park).

**Leaving the Vehicle With the Engine Running** **WARNING**

It can be dangerous to leave the vehicle with the engine running. The vehicle could move suddenly if the shift lever is not fully in P (Park) with the parking brake firmly set.

If you have four-wheel drive and the transfer case is in N (Neutral), the vehicle will be free to roll, even if the shift lever is in P (Park). So be sure the transfer case is in a drive gear — not in N (Neutral).

And, if you leave the vehicle with the engine running, it could overheat and even catch fire. You or others could be injured. Do not leave the vehicle with the engine running unless you have to.

If you have to leave the vehicle with the engine running, be sure your vehicle is in P (Park) and the parking brake is firmly set before you leave it. After you move the shift lever into P (Park), hold the regular brake pedal down. Then, see if you can move the shift lever away from P (Park) without first pulling it toward you. If you can, it means that the shift lever was not fully locked into P (Park).

**Torque Lock**

If you are parking on a hill and you do not shift your transmission into P (Park) properly, the weight of the vehicle may put too much force on the parking pawl in the transmission. You may find it difficult to pull the shift lever out of P (Park). This is called torque lock. To prevent torque lock, set the parking brake and then shift into P (Park) properly before you leave the driver seat. To find out how, *Shifting Into Park* on page 9-28.

## 9-30 Driving and Operating

When you are ready to drive, move the shift lever out of P (Park) before you release the parking brake.

If torque lock does occur, you may need to have another vehicle push yours a little uphill to take some of the pressure from the parking pawl in the transmission, then you will be able to pull the shift lever out of P (Park).

### Shifting out of Park

This vehicle is equipped with an electronic shift lock release system. The shift lock release is designed to:

- Prevent ignition key removal unless the shift lever is in P (Park) with the shift lever button fully released.
- Prevent movement of the shift lever out of P (Park), unless the ignition is in ON/RUN or ACC/ACCESSORY and the regular brake pedal is applied.

The shift lock release is always functional except in the case of an uncharged or low voltage (less than 9 volt) battery.

If the vehicle has an uncharged battery or a battery with low voltage, try charging or jump starting the battery. See *Jump Starting on page 10-82* for more information.

To shift out of P (Park) use the following:

1. Apply the brake pedal.
2. Move the shift lever to the desired position.

If you still are unable to shift out of P (Park):

1. Ease the pressure on the shift lever.
2. While holding down the brake pedal, press the shift lever all the way into P (Park).
3. Move the shift lever to the desired position.

If you are still having a problem shifting, then have the vehicle serviced soon.

### Parking over Things That Burn



Things that can burn could touch hot exhaust parts under the vehicle and ignite. Do not park over papers, leaves, dry grass, or other things that can burn.

### Active Fuel Management®

Vehicles with V8 engines may have Active Fuel Management. This system allows the engine to operate on either all or half of its cylinders, depending on the driving conditions.



When less power is required, such as cruising at a constant vehicle speed, the system will operate in the half cylinder mode, allowing the vehicle to achieve better fuel economy. When greater power demands are required, such as accelerating from a stop, passing, or merging onto a freeway, the system will maintain full-cylinder operation.

If the vehicle has an Active Fuel Management indicator, see *Driver Information Center (DIC)* on page 5-28 for more information on using this display.

## Engine Exhaust

### WARNING

Engine exhaust contains carbon monoxide (CO) which cannot be seen or smelled. Exposure to CO can cause unconsciousness and even death.

Exhaust may enter the vehicle if:

- The vehicle idles in areas with poor ventilation (parking garages, tunnels, deep snow that may block underbody airflow or tail pipes).
- The exhaust smells or sounds strange or different.
- The exhaust system leaks due to corrosion or damage.
- The vehicle exhaust system has been modified, damaged, or improperly repaired.

(Continued)

### WARNING (Continued)

- There are holes or openings in the vehicle body from damage or aftermarket modifications that are not completely sealed.

If unusual fumes are detected or if it is suspected that exhaust is coming into the vehicle:

- Drive it only with the windows completely down.
- Have the vehicle repaired immediately.

Never park the vehicle with the engine running in an enclosed area such as a garage or a building that has no fresh air ventilation.

### Running the Vehicle While Parked

It is better not to park with the engine running.

If the vehicle is left with the engine running, follow the proper steps to be sure the vehicle will not move. See *Shifting Into Park* on page 9-28 and *Engine Exhaust* on page 9-31.

If parking on a hill and pulling a trailer, see *Driving Characteristics and Towing Tips* on page 9-71.

### Automatic Transmission

If the vehicle is a hybrid, see the hybrid supplement for more information.

Vehicles with an automatic transmission have an electronic shift position indicator within the instrument panel cluster. This display comes on when the ignition key is turned to the ON/RUN position.

There are several different positions for the shift lever.

**P R N D 3 2 1**

**Hydra-Matic® 4-Speed Automatic Transmission**

**P R N D M 1**

**Heavy Duty 6-Speed Automatic Transmission Shown (Light Duty 6-Speed Similar)**

See "Range Selection Mode" under *Manual Mode* on page 9-36.

**P (Park):** This position locks the rear wheels. It is the best position to use when starting the engine because the vehicle cannot move easily. When parked on a hill,

especially when the vehicle has a heavy load, you might notice an increase in the effort to shift out of P (Park). See “Torque Lock” under *Shifting Into Park* on page 9-28 for more information.

 **WARNING**

It is dangerous to get out of the vehicle if the shift lever is not fully in P (Park) with the parking brake firmly set. The vehicle can roll.

Do not leave the vehicle when the engine is running. If you have left the engine running, the vehicle can move suddenly. You or others could be injured. To be sure the vehicle will not move, even when you are on fairly level ground, always set the parking brake and move the shift lever to P (Park). See *Shifting Into Park* on page 9-28 and *Driving Characteristics and Towing Tips* on page 9-71.

 **WARNING**

If you have Four-Wheel Drive, the vehicle will be free to roll — even if the shift lever is in P (Park) — if the transfer case is in Neutral. So, be sure the transfer case is in a drive gear, Two-Wheel Drive High or Four-Wheel Drive High or Four-Wheel Drive Low — not in Neutral. See *Shifting Into Park* on page 9-28.

**R (Reverse):** Use this gear to back up.

**Notice: Shifting to R (Reverse) while the vehicle is moving forward could damage the transmission. The repairs would not be covered by the vehicle warranty. Shift to R (Reverse) only after the vehicle is stopped.**

To rock the vehicle back and forth to get out of snow, ice, or sand without damaging the transmission, see *If the Vehicle Is Stuck* on page 9-14.

**N (Neutral):** In this position, the engine does not connect with the wheels. To restart when you are already moving, use N (Neutral) only. Also, use N (Neutral) when the vehicle is being towed.

 **WARNING**

Shifting into a drive gear while the engine is running at high speed is dangerous. Unless your foot is firmly on the brake pedal, the vehicle could move very rapidly. You could lose control and hit people or objects. Do not shift into a drive gear while the engine is running at high speed.

**Notice: Shifting out of P (Park) or N (Neutral) with the engine running at high speed may damage the transmission. The repairs would not be covered by the vehicle warranty. Be sure the engine is not running at high speed when shifting the vehicle.**

## 9-34 Driving and Operating

---

**D (Drive):** This position is for normal driving. It provides the best fuel economy. If you need more power for passing, and you are:

- Going less than about 55 km/h (35 mph), push the accelerator pedal about halfway down.
- Going about 55 km/h (35 mph) or more, push the accelerator all the way down.

By doing this, the vehicle shifts down to the next gear and has more power.

D (Drive) can be used when towing a trailer, carrying a heavy load, driving on steep hills, or for off-road driving. You might want to shift the transmission to a lower gear selection if the transmission shifts too often.

Downshifting the transmission in slippery road conditions could result in skidding. See “Skidding” under *Loss of Control on page 9-5*.

The vehicle has a shift stabilization feature that adjusts the transmission shifting to the current driving conditions in order to reduce rapid upshifts and downshifts. This shift stabilization feature is designed to determine, before making an upshift, if the engine is able to maintain vehicle speed by analyzing things such as vehicle speed, throttle position, and vehicle load.

If the shift stabilization feature determines that a current vehicle speed cannot be maintained, the transmission does not upshift and instead holds the current gear. In some cases, this could appear to be a delayed shift, however the transmission is operating normally.

The transmission uses adaptive shift controls. Adaptive shift controls continually compares key shift parameters to pre-programmed ideal shifts stored in the transmissions computer. The transmission constantly makes adjustments to improve vehicle performance according to how the

vehicle is being used, such as with a heavy load or when temperature changes. During this adaptive shift control process, shifting might feel different as the transmission determines the best settings.

When temperatures are very cold, the Allison Transmission and Hydra-Matic 6-Speed transmission's gear shifting could be delayed providing more stable shifts until the engine warms up. Shifts could be more noticeable with a cold transmission. This difference in shifting is normal.

**M (Manual Mode):** This position is available on vehicles with the Allison Transmission or Hydra-Matic 6-Speed transmission. It lets drivers select the range of gears appropriate for current driving conditions. If the vehicle has this feature, see “Range Selection Mode” under *Manual Mode on page 9-36*.

**3 (Third):** This position is also used for normal driving. It reduces vehicle speed more than D (Drive) without using the brakes. You might choose 3 (Third) instead of D (Drive) when driving on hilly, winding roads, when towing a trailer, so there is less shifting between gears and when going down a steep hill.

**2 (Second):** This position reduces vehicle speed even more than 3 (Third) without using the brakes. You can use 2 (Second) on hills. It can help control vehicle speed as you go down steep mountain roads, but then you would also want to use the brakes off and on.

If you manually select 2 (Second) in an automatic transmission, the transmission will start in second gear. You can use this feature for reducing the speed of the rear wheels when you are trying to start the vehicle from a stop on slippery road surfaces.

**1 (First):** For the Hydra-Matic 4-Speed transmission this position reduces vehicle speed even more than 2 (Second) without using the brakes. You can use it on very steep hills, or in deep snow or mud. If the shift lever is put in 1 (First) while the vehicle is moving forward, the transmission does not shift into first gear until the vehicle is going slowly enough.

For an Allison Transmission or Hydra-Matic 6-Speed transmission, this position reduces vehicle speed without using the brakes. You can use it for major/severe downgrades and off-road driving where the vehicle would otherwise accelerate due to steepness of grade. When you shift to 1 (First) it provides the lowest gear appropriate to current road speed and continues to downshift as the vehicle slows, eventually downshifting to 1 (First) gear.

**Notice:** Spinning the tires or holding the vehicle in one place on a hill using only the

accelerator pedal may damage the transmission. The repair will not be covered by the vehicle warranty. If you are stuck, do not spin the tires. When stopping on a hill, use the brakes to hold the vehicle in place.

### Normal Mode Grade Braking

Vehicles with a gasoline engine and 6-Speed automatic transmission have Normal Mode Grade Braking that is enabled when the vehicle is started, but is not enabled in Range Selection Mode. It assists in maintaining desired vehicle speeds when driving on downhill grades by using the engine and transmission to slow the vehicle. The first time the system engages for each ignition key cycle, a DIC message will be displayed. See *Transmission Messages on page 5-44*.

To disable or enable Normal Mode Grade Braking within the current ignition key cycle, press and hold the Tow/Haul button for

## 9-36 Driving and Operating

three seconds. A DIC message displays. See *Transmission Messages on page 5-44*.

For iother forms of grade braking, see *Tow/Haul Mode on page 9-37* and *Cruise Control on page 9-56*.

### Manual Mode

#### Range Selection Mode (Allison® Transmission or Hydra-Matic® 6-Speed Transmission)



The vehicle may have a Range Selection Mode. The Range Selection Mode helps control the vehicle's transmission and vehicle speed while driving down hill or towing a trailer by letting you select a desired range of gears.

To use this feature, do the following:

1. Move the shift lever to M (Manual Mode).
2. Press the plus/minus buttons, located on the steering column shift lever, to select the desired range of gears for current driving conditions.

When M (Manual Mode) is selected a number displays next to the M, indicating the current gear.

This number is the highest gear that can be used. However, the vehicle can automatically shift to lower gears as it adjusts to driving conditions. This means that all gears below that number are available. When 5 (Fifth) is selected, 1 (First) through 5 (Fifth) gears are automatically shifted by the vehicle, but 6 (Sixth) cannot be used until the plus/minus button located on the steering column lever is used to change to the gear.

Grade Braking is not available when Range Selection Mode is active. See *Tow/Haul Mode on page 9-37*.

While using Range Selection Mode, Cruise Control and the Tow/Haul Mode can be used.

If the vehicle has an exhaust brake, it can also be used, but will not automatically downshift the transmission. See Exhaust Brake in the Duramax Diesel supplement.

**Notice: Spinning the tires or holding the vehicle in one place on a hill using only the accelerator pedal may damage the transmission. The repair will not be covered by the vehicle warranty. If you are stuck, do not spin the tires. When stopping on a hill, use the brakes to hold the vehicle in place.**

## Low Traction Mode

If the vehicle has the Allison Transmission, a 4-Speed automatic transmission, or the Hydra-Matic 6-Speed Automatic Transmission with the 6.0L engine, it has a Low Traction Mode that assists in vehicle acceleration when road conditions are slippery, such as with ice or snow. While the vehicle is at a stop, select the second gear range using Range Selection Mode. This will limit torque to the wheels helping to prevent the tires from spinning.

## Tow/Haul Mode

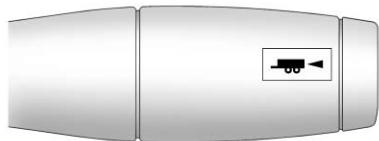

**4-Speed Automatic Transmission**

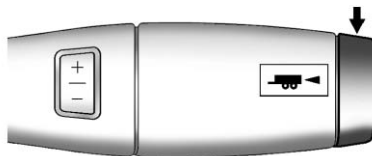

**6-Speed Automatic Transmission**

Vehicles with an automatic transmission have a Tow/Haul Mode. The Tow/Haul Mode adjusts the transmission shift pattern to reduce shift cycling, providing increased performance, vehicle control, and transmission cooling when driving down steep hills or Mountain grades, towing, or hauling heavy loads.

The selector button is located on the end of the shift lever. Turn the Tow/Haul Mode on and off by pressing the button. When the Tow/Haul Mode is enabled, a light on the instrument panel cluster will come on.

See *Tow/Haul Mode Light* on page 5-25 and *Hill and Mountain Roads* on page 9-11 for more information.

Also see “Tow/Haul Mode” under *Towing Equipment* on page 9-89 for more information.

## Tow/Haul Mode Grade Braking (6-Speed Automatic Transmission)

Tow/Haul Mode Grade Braking is only enabled while the Tow/Haul Mode is selected and the vehicle is not in the Range Selection Mode. See “Tow/Haul Mode” listed previously and *Manual Mode* on page 9-36. Tow/Haul Mode Grade Braking assists in maintaining desired vehicle speeds when driving on downhill grades by using the engine and transmission to slow the vehicle.

On vehicles with a gasoline engine, to disable or enable Tow/Haul Grade Braking within the current ignition key cycle, press and hold the Tow/Haul button for three seconds. A DIC message will be displayed. See *Transmission Messages* on page 5-44.

On vehicles with a diesel engine, Tow/Haul Mode Grade Braking can be enabled or disabled by pressing the Tow/Haul Mode button. Use the exhaust brake and Tow/Haul Mode for maximum grade braking.

See *Towing Equipment* on page 9-89 for more information.

For other forms of grade braking, see *Automatic Transmission* on page 9-32 and *Cruise Control* on page 9-56.

## Drive Systems

### Four-Wheel Drive

If the vehicle has Four-Wheel Drive, you can send the engine's driving power to all four wheels for extra traction. To get the most satisfaction out of Four-Wheel Drive, you must be familiar with its operation. Read the following before using Four-Wheel Drive. See the appropriate text for the transfer case in the vehicle.

**Notice:** Driving on clean, dry pavement in Four-Wheel Drive High or Four-Wheel Drive Low for an extended period of time may cause premature wear on the vehicle's powertrain. Do not drive on clean, dry pavement in Four-Wheel Drive High or Four-Wheel Drive Low for extended periods of time.

While driving on clean dry pavement and during tight turns, you may experience vibration in the steering system.

If the vehicle has StabiliTrak<sup>®</sup>, shifting into Four-Wheel Drive Low will turn Traction Control and StabiliTrak off. See *StabiliTrak<sup>®</sup> System* on page 9-53.

### Front Axle

The front axle engages and disengages automatically when you shift the transfer case. Some delay for the axle to engage or disengage is normal.

### Manual Transfer Case

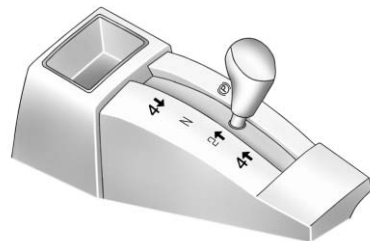



The transfer case shift lever is on the floor to the right of the driver. Use this lever to shift into and out of Four-Wheel Drive.



A Four-Wheel Drive indicator light comes on when you shift into four-wheel drive and the front axle engages. See *Four-Wheel-Drive Light* on page 5-25.

Some delay between shifting and when the indicator light comes on is normal.

### Recommended Transfer Case Settings

Driving Conditions	Transfer Case Settings			
	2↑	4↑	4↓	N
Normal	YES			
Severe		YES		
Extreme			YES	
Vehicle in Tow*				YES

\*See *Recreational Vehicle Towing* on page 10-87 or *Towing the Vehicle* on page 10-87.

**Notice:** Driving on clean, dry pavement in four-wheel drive for an extended period of time can cause premature wear on the vehicle's powertrain. Do not drive on clean, dry pavement in Four-Wheel Drive for extended periods of time.

**4 ↓ (Four-Wheel Drive Low):** This setting also engages the front axle and delivers extra torque. You may never need Four-Wheel Drive Low. It sends maximum power to all four wheels. You might choose Four-Wheel Drive Low if you are driving off-road in deep sand, deep mud, deep snow, and while climbing or descending steep hills.

If the vehicle has StabiliTrak<sup>®</sup>, shifting into Four-Wheel Drive Low will turn Traction Control and StabiliTrak off. See *StabiliTrak<sup>®</sup> System* on page 9-53.



A parking brake symbol is located next to the N (Neutral) symbol as a reminder to set the parking brake before shifting the transfer case into N (Neutral).

### WARNING

Shifting the transfer case to N (Neutral) can cause the vehicle to roll even if the transmission is in P (Park). You or someone else could be seriously injured. Be sure to set the parking brake

(Continued)

### WARNING (Continued)

before placing the transfer case in N (Neutral). See *Parking Brake* on page 9-51.

**N (Neutral):** Shift to this setting only when the vehicle needs to be towed. See *Recreational Vehicle Towing* on page 10-87 or *Towing the Vehicle* on page 10-87.

**2 ↑ (Two-Wheel Drive High):** This setting is used for driving in most street and highway situations. The front axle is not engaged in two-wheel drive. This setting also provides the best fuel economy.

**4 ↑ (Four-Wheel Drive High):** Use this setting when you need extra traction, such as on snowy or icy roads or in most off-road situations. This setting also engages the front axle to help drive your vehicle. This is the best setting to use when plowing snow.

You can shift from Two-Wheel Drive High to Four-Wheel Drive High or Four-Wheel Drive High to Two-Wheel Drive High while the vehicle is moving. In extremely cold weather, it may be necessary to stop or slow the vehicle to shift into Four-Wheel Drive High.

### When Using the Manual Transfer Case

- Shifts into or out of Four-Wheel Drive Low or N (Neutral) should be made using quick motions to avoid excessive gear grinding. Shifting slowly may make it more difficult to shift.
- You may notice that it is harder to shift when the vehicle is cold. After the vehicle warms up the shifting will return to normal.
- While in Four-Wheel High or Four-Wheel Drive Low you may experience reduced fuel economy.

- Avoid driving in Four-Wheel Drive on clean, dry pavement. It may cause your tires to wear faster, make the transfer case harder to shift, and run noisier.
- If the transfer case shifter is in the N (Neutral) position and you have difficulty reaching the selected transfer case mode, with the engine running, shift the transmission momentarily to D (Drive) and then back to N (Neutral). This will realign the gear teeth in the transfer case and allow you to complete the shift.

**Shifting from Two-Wheel Drive High to Four-Wheel Drive High**

- Shifts between Two-Wheel Drive High and Four-Wheel Drive High can be made at any vehicle speed.
- Shift the transfer case lever in one continuous motion into either the Four-Wheel Drive High or Two-Wheel Drive High position.

- Shifting from Two-Wheel Drive High to Four-Wheel Drive High while the vehicle is in motion may require that moderate force be applied to the shift lever for a few seconds before Four-Wheel Drive High can be engaged, especially in cold weather.
- In extremely cold weather, it may be necessary to slow or stop the vehicle to shift into Four-Wheel Drive High.
- While in Four-Wheel Drive High, the vehicle can be driven at any posted legal speed limit.

**Shifting In or Out of Four-Wheel Drive Low**

**Notice:** Shifting the transfer case into Four-Wheel-Drive Low while moving at speeds faster than 5 km/h (3 mph) may cause premature wear to the transfer

**case, and may cause the gears to grind. To avoid causing premature wear, and grinding the gears, do not shift the transfer case into Four-Wheel-Drive Low while the vehicle is moving faster than 5 km/h (3 mph).**

- Shifting into Four-Wheel Drive Low should be done, if possible, with the vehicle at a slight roll, 5 km/h (3 mph) or less.
- Shift the transmission into N (Neutral).

 **WARNING**

Shifting the transfer case to N (Neutral) can cause the vehicle to roll even if the transmission is in P (Park). You or someone else could be seriously injured. Be sure to set the parking brake before placing the transfer case in N (Neutral). See *Parking Brake* on page 9-51.

## 9-42 Driving and Operating

- Shifting into Four-Wheel Drive Low with the vehicle at a stop may be more difficult. You may be unable to complete the shift to Four-Wheel Drive Low, and the transfer case will end up in N (Neutral). This is normal, and is a function of the gear teeth aligning in the transfer case. When this happens, make sure the engine is on, shift the transmission momentarily to D (Drive) and back to N (Neutral), and then complete the transfer case shift.
- Shift the transfer case shift lever in one continuous motion into the Four-Wheel Drive Low position.
- When in Four-Wheel Drive Low do not drive faster than 72 km/h (45 mph). This will reduce wear and extend the life of your transfer case.

### Shifting In or Out of Neutral

1. With the vehicle running and the engine at an idle, set the parking brake.
2. Place the transmission into N (Neutral).

Shift the transfer case in one continuous motion into or out of the N (Neutral) position.

### Electronic Transfer Case

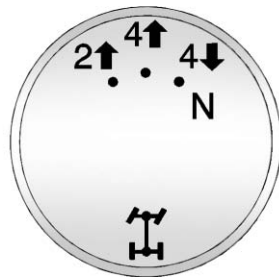

The transfer case knob is located next to the steering column.

Use the dial to shift into and out of four-wheel drive.

### Recommended Transfer Case Settings

Driving Conditions	Transfer Case Settings			
	2↑	4↑	4↓	N
Normal	YES			
Severe		YES		
Extreme			YES	
Vehicle in Tow*				YES

\*See *Recreational Vehicle Towing on page 10-87* or *Towing the Vehicle on page 10-87*.

You can choose among four driving settings:

Indicator lights in the dial show which setting you are in. The indicator lights will come on briefly when you turn on the ignition and one will stay on. If the lights do not come on, you should take the vehicle to your dealer for service.

An indicator light flashes while shifting the transfer case and remains illuminated when the shift is complete. If for some reason the transfer case cannot make a requested shift, it will return to the last chosen setting.

**2 ↑ (Two-Wheel Drive High):** This setting is used for driving in most street and highway situations. The front axle is not engaged in Two-Wheel Drive. This setting also provides the best fuel economy.

**4 ↑ (Four-Wheel Drive High):** Use the Four-Wheel Drive High position when extra traction is needed, such as on snowy or icy roads or in most off-road situations. This setting also engages the front axle to help drive the vehicle. This is the best setting to use when plowing snow.

**4 ↓ (Four-Wheel Drive Low):** This setting also engages the front axle and delivers extra torque. You may never need this setting. It sends maximum power to all four wheels. You might choose Four-Wheel Drive Low while driving off-road in deep sand, deep mud, deep snow, and while climbing or descending steep hills.

If the vehicle has StabiliTrak<sup>®</sup>, shifting into Four-Wheel Drive Low will turn Traction Control and StabiliTrak<sup>®</sup> off. See *StabiliTrak<sup>®</sup> System on page 9-53*.

### WARNING

Shifting the transfer case to N (Neutral) can cause the vehicle to roll even if the transmission is in P (Park). You or someone else could be seriously injured. Be sure to set the parking brake before placing the transfer case in N (Neutral). See *Parking Brake* on page 9-51.

**N (Neutral):** Shift the vehicle's transfer case to N (Neutral) only when towing the vehicle. See *Recreational Vehicle Towing* on page 10-87 or *Towing the Vehicle* on page 10-87 for more information.

If the SERVICE 4 WHEEL DRIVE message stays on, you should take the vehicle to your dealer for service. See "SERVICE 4 WHEEL DRIVE" under *Transmission Messages* on page 5-44.

### Shifting Into Two-Wheel Drive High

Turn the knob to the Two-Wheel Drive High position. This can be done at any speed, except when shifting from Four-Wheel Drive Low. See "Shifting Out of Four-Wheel Drive Low" for more information.

### Shifting Into Four-Wheel Drive Low

When Four-Wheel Drive Low is engaged, vehicle speed should be kept below 72 km/h (45 mph). Extended high-speed operation in Four-Wheel Drive Low may damage or shorten the life of the drivetrain.

To shift to the Four-Wheel Drive Low position, the ignition must be in ON/RUN and the vehicle must be stopped or moving less than 5 km/h (3 mph) with the transmission in N (Neutral). The preferred method for shifting into Four-Wheel Drive Low is to have the vehicle moving 1.6 to 3.2 km/h (1 to 2 mph). Turn the knob to the Four-Wheel Drive Low position. You must wait for the

Four-Wheel Drive Low indicator light to stop flashing and remain on before shifting the transmission in gear.

**Notice:** Shifting the transmission into gear before the requested mode indicator light has stopped flashing could damage the transfer case. To help avoid damaging the vehicle, always wait for the mode indicator lights to stop flashing before shifting the transmission into gear.

It is typical for the vehicle to exhibit significant engagement noise and bump when shifting between Four-Wheel Drive Low and Four-Wheel Drive High ranges or from transfer case N (Neutral) with the engine running.

If the knob is turned to the Four-Wheel Drive Low position when the vehicle is in gear and/or moving more than 5 km/h (3 mph), the Four-Wheel Drive Low indicator light will flash for 30 seconds and not complete the shift. After

30 seconds the transfer case will shift to Four-Wheel Drive High mode. With the vehicle moving less than 5 km/h (3 mph), and the transmission in N (Neutral), attempt the shift again.

### Shifting Out of Four-Wheel Drive Low

To shift from Four-Wheel Drive Low to Four-Wheel Drive High, or Two-Wheel Drive High, the vehicle must be stopped or moving less than 5 km/h (3 mph) with the transmission in N (Neutral) and the ignition in ON/RUN. The preferred method for shifting out of Four-Wheel Drive Low is to have the vehicle moving 1.6 to 3.2 km/h (1 to 2 mph). Turn the knob to the Four-Wheel Drive High or Two-Wheel Drive High position. You must wait for the Four-Wheel Drive High or Two-Wheel Drive High indicator light to stop flashing and remain on before shifting the transmission into gear.

**Notice:** Shifting the transmission into gear before the requested mode indicator light has stopped flashing could damage the transfer case. To help avoid damaging the vehicle, always wait for the mode indicator lights to stop flashing before shifting the transmission into gear.

It is typical for the vehicle to exhibit significant engagement noise and bump when shifting between Four-Wheel Drive Low and Four-Wheel Drive High ranges or from transfer case N (Neutral) with the engine running.

If the knob is turned to the Four-Wheel Drive High, or Two-Wheel Drive High switch position when the vehicle is in gear and/or moving more than 5 km/h (3 mph), the Four-Wheel Drive High, AUTO, or Two-Wheel Drive High indicator light will flash for 30 seconds but will not complete the shift. With the vehicle moving

less than 5 km/h (3 mph), and the transmission in N (Neutral), attempt the shift again.

### Shifting into Neutral

To shift the transfer case to N (Neutral) do the following:

1. Make sure the vehicle is parked so that it will not roll.
2. Set the parking brake and press and hold the regular brake pedal. See *Parking Brake on page 9-51* for more information.
3. Start the vehicle or turn the ignition to ON/RUN.
4. Shift the transmission to N (Neutral).
5. Shift the transfer case to Two-Wheel Drive High.
6. Turn the transfer case dial clockwise to N (Neutral) until it stops and hold it there until the Neutral light starts blinking. This will take at least 10 seconds.

## 9-46 Driving and Operating

Then slowly release the dial to the four low position. The N (Neutral) light will come on when the transfer case shift to N (Neutral) is complete.

7. If the engine is running, verify that the transfer case is in N (Neutral) by shifting the transmission to R (Reverse) for one second, then shift the transmission to D (Drive) for one second.
8. Turn the ignition to ACC/ACCESSORY, which will turn the engine off.
9. Place the transmission shift lever in P (Park).
10. Release the parking brake prior to moving the vehicle.
11. Turn the ignition to LOCK/OFF.

### Shifting Out of Neutral

To shift the transfer case out of N (Neutral) do the following:

1. Set the parking brake and apply the regular brake pedal.

2. Turn the ignition to ON/RUN with the engine off, and shift the transmission to N (Neutral).

3. Turn the transfer case dial to Two-Wheel Drive High.

After the transfer case has shifted out of N (Neutral), the N (Neutral) light will go out.

4. Release the parking brake prior to moving the vehicle.

**Notice:** Shifting the transmission into gear before the requested mode indicator light has stopped flashing could damage the transfer case. To help avoid damaging the vehicle, always wait for the mode indicator lights to stop flashing before shifting the transmission into gear.

5. Start the engine and shift the transmission to the desired position.

Excessively shifting the transfer case into or out of the different modes may cause the transfer case to enter the shift protection mode.

This will protect the transfer case from possible damage and will only allow the transfer case to respond to one shift per 10 seconds. The transfer case may stay in this mode for up to three minutes.

### Automatic Transfer Case

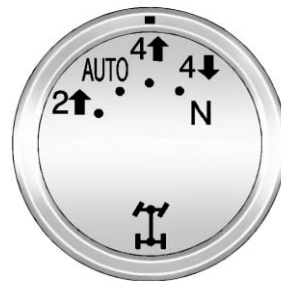

The transfer case knob is located next to the steering column.

Use the dial to shift into and out of Four-Wheel Drive.



You can choose among five driving settings:

Indicator lights in the dial show which setting you are in. The indicator lights will come on briefly when you turn on the ignition and one will stay on. If the lights do not come on, you should take the vehicle to your dealer for service. An indicator light will flash while shifting the transfer case. It will remain illuminated when the shift is complete. If for some reason the transfer case cannot make a requested shift, it will return to the last chosen setting.

**2 ↑ (Two-Wheel Drive High):** This setting is used for driving in most street and highway situations. The front axle is not engaged in Two-Wheel Drive. This setting also provides the best fuel economy.

**AUTO (Automatic Four-Wheel Drive):** This setting is ideal for use when road surface traction conditions are variable. When driving the vehicle in AUTO, the

front axle is engaged, but the vehicle's power is sent only to the front and rear wheels automatically based on driving conditions. Driving in this mode results in slightly lower fuel economy than Two-Wheel Drive High.

**4 ↑ (Four-Wheel Drive High):** Use the Four-Wheel Drive High position when extra traction is needed, such as on snowy or icy roads or in most off-road situations. This setting also engages the front axle to help drive the vehicle. This is the best setting to use when plowing snow.

**4 ↓ (Four-Wheel Drive Low):** This setting also engages the front axle and delivers extra torque. You may never need this setting. It sends maximum power to all four wheels. You might choose Four-Wheel Drive Low if you are driving off-road in deep sand, deep mud, deep snow, and while climbing or descending steep hills.

If the vehicle has StabiliTrak<sup>®</sup>, shifting into Four-Wheel Drive Low will turn Traction Control and StabiliTrak off. See *StabiliTrak<sup>®</sup> System on page 9-53*.

 **WARNING**

Shifting the transfer case to N (Neutral) can cause the vehicle to roll even if the transmission is in P (Park). You or someone else could be seriously injured. Be sure to set the parking brake before placing the transfer case in N (Neutral). See *Parking Brake on page 9-51*.

**N (Neutral):** Shift the vehicle's transfer case to N (Neutral) only when towing the vehicle. See *Recreational Vehicle Towing on page 10-87* or *Towing the Vehicle on page 10-87* for more information.

If the SERVICE 4 WHEEL DRIVE message stays on, you should take the vehicle to your dealer for service. See “SERVICE 4 WHEEL DRIVE” under *Transmission Messages on page 5-44*.

### Shifting Into Four-Wheel Drive High or AUTO (Automatic Four-Wheel Drive)

Turn the knob to the Four-Wheel Drive High or AUTO position. This can be done at any speed, except when shifting from Four-Wheel Drive Low. The indicator light will flash while shifting. It will remain on when the shift is completed.

### Shifting Into Two-Wheel Drive High

Turn the knob to the Two-Wheel Drive High position. This can be done at any speed, except when shifting from Four-Wheel Drive Low. The indicator light will flash while shifting. It will remain on when the shift is completed.

### Shifting Into Four-Wheel Drive Low

When Four-Wheel Drive Low is engaged, vehicle speed should be kept below 72 km/h (45 mph). Extended high-speed operation in Four-Wheel Drive Low may damage or shorten the life of the drivetrain.

To shift to the Four-Wheel Drive Low position, the ignition must be in ON/RUN and the vehicle must be stopped or moving less than 5 km/h (3 mph) with the transmission in N (Neutral). The preferred method for shifting into Four-Wheel Drive Low is to have the vehicle moving 1.6 to 3.2 km/h (1 to 2 mph). Turn the knob to the Four-Wheel Drive Low position. You must wait for the Four-Wheel Drive Low indicator light to stop flashing and remain on before shifting the transmission into gear.

**Notice:** Shifting the transmission into gear before the requested mode indicator light has stopped flashing could damage the

transfer case. To help avoid damaging the vehicle, always wait for the mode indicator lights to stop flashing before shifting the transmission into gear.

It is typical for the vehicle to exhibit significant engagement noise and bump when shifting between Four-Wheel Drive Low and Four-Wheel Drive High ranges or from N (Neutral) with the engine running.

If the knob is turned to the Four-Wheel Drive Low position when the vehicle is in gear and/or moving more than 5 km/h (3 mph), the Four-Wheel Drive Low indicator light will flash for 30 seconds and not complete the shift. After 30 seconds the transfer case will shift to Four-Wheel Drive High mode. With the vehicle moving less than 5 km/h (3 mph), and the transmission in N (Neutral), attempt the shift again.

### Shifting Out of Four-Wheel Drive Low

To shift from Four-Wheel Drive Low to Four-Wheel Drive High, AUTO or Two-Wheel Drive High, the vehicle must be stopped or moving less than 5 km/h (3 mph) with the transmission in N (Neutral) and the ignition in ON/RUN. The preferred method for shifting out of Four-Wheel Drive Low is to have the vehicle moving 1.6 to 3.2 km/h (1 to 2 mph). Turn the knob to the Four-Wheel Drive High, AUTO or Two-Wheel Drive High position. You must wait for the Four-Wheel Drive High, AUTO or Two-Wheel Drive High indicator light to stop flashing and remain on before shifting the transmission into gear.

**Notice:** Shifting the transmission into gear before the requested mode indicator light has stopped flashing could damage the transfer case. To help avoid damaging the vehicle, always wait

### for the mode indicator lights to stop flashing before shifting the transmission into gear.

It is typical for the vehicle to exhibit significant engagement noise and bump when shifting between Four-Wheel Drive Low and Four-Wheel Drive High ranges or from N (Neutral) with the engine running.

If the knob is turned to the Four-Wheel Drive High, AUTO, or Two-Wheel Drive High switch position when the vehicle is in gear and/or moving more than 5 km/h (3 mph), the Four-Wheel Drive High, AUTO or Two-Wheel Drive High indicator light will flash for 30 seconds but will not complete the shift. With the vehicle moving less than 5 km/h (3 mph), and the transmission in N (Neutral), attempt the shift again.

### Shifting into Neutral

To shift the transfer case to N (Neutral) do the following:

1. Make sure the vehicle is parked so that it will not roll.
2. Set the parking brake and apply the regular brake pedal. See *Parking Brake on page 9-51* for more information.
3. Start the vehicle or turn the ignition in ON/RUN.
4. Put the transmission in N (Neutral).
5. Shift the transfer case to Two-Wheel Drive High.
6. Turn the transfer case dial clockwise to N (Neutral) until it stops and hold it there until the N (Neutral) light starts blinking. This will take at least 10 seconds. Then slowly release the dial to the four low position. The N (Neutral) light will come on when the transfer case shift to N (Neutral) is complete.

7. If the engine is running, make sure that the transfer case is in N (Neutral) by shifting the transmission to R (Reverse) for one second, then shift the transmission to D (Drive) for one second.
8. Turn the ignition to ACC/ACCESSORY, which will turn the engine off.
9. Place the transmission shift lever in P (Park).
10. Release the parking brake prior to moving the vehicle.
11. Turn the ignition to LOCK/OFF.

### Shifting Out of Neutral

To shift out of N (Neutral) do the following:

1. Set the parking brake and apply the regular brake pedal.
2. Turn the ignition to ON/RUN with the engine off, and shift the transmission to N (Neutral).

3. Turn the transfer case dial to Two-Wheel Drive High, Four-Wheel Drive High, or AUTO.

After the transfer case has shifted out of N (Neutral), the N (Neutral) light will go out.

4. Release the parking brake prior to moving the vehicle.

**Notice:** Shifting the transmission into gear before the requested mode indicator light has stopped flashing could damage the transfer case. To help avoid damaging the vehicle, always wait for the mode indicator lights to stop flashing before shifting the transmission into gear.

5. Start the engine and shift the transmission to the desired position.

## Brakes

### Antilock Brake System (ABS)

This vehicle has the Antilock Brake System (ABS), an advanced electronic braking system that helps prevent a braking skid.

When the engine is started and the vehicle begins to drive away, ABS checks itself. A momentary motor or clicking noise might be heard while this test is going on, and it might even be noticed that the brake pedal moves a little. This is normal.



If there is a problem with ABS, this warning light stays on. See *Antilock Brake System (ABS) Warning Light* on page 5-24.

If driving safely on a wet road and it becomes necessary to slam on the brakes and continue braking to avoid a sudden obstacle, a computer senses that the wheels are slowing down. If one of the wheels is about to stop rolling, the computer will separately work the brakes at each wheel.

ABS can change the brake pressure to each wheel, as required, faster than any driver could. This can help the driver steer around the obstacle while braking hard.

As the brakes are applied, the computer keeps receiving updates on wheel speed and controls braking pressure accordingly.

Remember: ABS does not change the time needed to get a foot up to the brake pedal or always decrease stopping distance. If you get too close to the vehicle in front of you,

there will not be enough time to apply the brakes if that vehicle suddenly slows or stops. Always leave enough room up ahead to stop, even with ABS.

### Using ABS

Do not pump the brakes. Just hold the brake pedal down firmly and let ABS work. You might hear the ABS pump or motor operating and feel the brake pedal pulsate, but this is normal.

### Braking in Emergencies

ABS allows the driver to steer and brake at the same time. In many emergencies, steering can help more than even the very best braking.

## Parking Brake

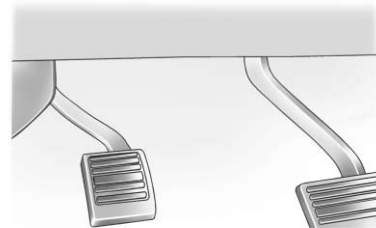

Set the parking brake by holding the regular brake pedal down, then pushing down the parking brake pedal.

If the ignition is on, the brake system warning light will come on. See *Brake System Warning Light* on page 5-23.

**Notice:** Driving with the parking brake on can overheat the brake system and cause premature wear or damage to brake system parts. Make sure that the parking

### **brake is fully released and the brake warning light is off before driving.**

To release the parking brake, hold the regular brake pedal down, then push down momentarily on the parking brake pedal until you feel the pedal release. Slowly pull your foot up off the parking brake pedal. If the parking brake is not released when you begin to drive, the brake system warning light will flash and a chime will sound warning you that the parking brake is still on.

If you are towing a trailer and are parking on a hill, see *Driving Characteristics and Towing Tips* on page 9-71.

### **Brake Assist**

If this vehicle has StabiliTrak<sup>®</sup>, it also has a Brake Assist feature designed to assist the driver in stopping or decreasing vehicle speed in emergency driving conditions. This feature uses the stability system hydraulic brake

control module to supplement the power brake system under conditions where the driver has quickly and forcefully applied the brake pedal in an attempt to quickly stop or slow down the vehicle. The stability system hydraulic brake control module increases brake pressure at each corner of the vehicle until the ABS activates. Minor brake pedal pulsation or pedal movement during this time is normal and the driver should continue to apply the brake pedal as the driving situation dictates. The Brake Assist feature will automatically disengage when the brake pedal is released or brake pedal pressure is quickly decreased.

### **Hill Start Assist (HSA)**

Non-hybrid vehicles with StabiliTrak have a Hill Start Assist (HSA) feature, which may be useful when the vehicle is stopped on a grade. This feature is designed to prevent the vehicle from rolling, either

forward or rearward, during vehicle drive off. After the driver completely stops and holds the vehicle in a complete standstill on a grade, HSA will be automatically activated. During the transition period between when the driver releases the brake pedal and starts to accelerate to drive off on a grade, HSA holds the braking pressure for a maximum of two seconds to ensure that there is no rolling. The brakes will automatically release when the accelerator pedal is applied within the two-second window. If the vehicle is equipped with the Integrated Trailer Brake Control (ITBC) system, HSA may also apply the trailer brakes. It will not activate if the vehicle is in a drive gear and facing downhill or if the vehicle is facing uphill and in R (Reverse). There may be situations on minor hills (less than 5% grade) with a loaded vehicle or while pulling a trailer where HSA will not activate.

## Ride Control Systems

### StabiliTrak<sup>®</sup> System

The vehicle has a vehicle stability enhancement system called StabiliTrak. It is an advanced computer-controlled system that assists the driver with directional control of the vehicle in difficult driving conditions.

StabiliTrak activates when the computer senses a discrepancy between the intended path and the direction the vehicle is actually traveling. StabiliTrak selectively applies braking pressure at any one of the vehicle's brakes to assist the driver with keeping the vehicle on the intended path.

StabiliTrak is on automatically whenever the vehicle is started. To assist with directional control of the vehicle, the system should always be left on. Trailer Sway Control (TSC) is also on automatically when the vehicle is started. See *Trailer Sway Control (TSC)* on page 9-100.

When the vehicle is started and begins to move, the system performs several diagnostic checks to insure there are no problems. The system may be heard or felt while it is working. This is normal and does not mean there is a problem with the vehicle.

If cruise control is being used when StabiliTrak activates, the cruise control automatically disengages. The cruise control can be re-engaged when road conditions allow. See *Cruise Control* on page 9-56.

If the system fails to turn on or activate, the StabiliTrak light along with a message will be displayed on the Driver Information Center (DIC). If a DIC message appears, make sure the StabiliTrak system has not been turned off using the Traction Control System (TCS)/StabiliTrak button. Then turn the vehicle off, wait 15 seconds, and then turn it back on again to reset the system. If any of the messages still appear on the DIC, the vehicle should be

taken in for service. For more information on the DIC messages, see *Ride Control System Messages* on page 5-42.



The StabiliTrak light will flash on the instrument panel cluster when the system or the TSC feature is both on and activated.

The system may be heard or felt while it is working; this is normal.



The TCS/StabiliTrak button is located on the instrument panel.

## 9-54 Driving and Operating

---

The traction control part of StabiliTrak can be turned off by pressing and releasing the TCS/StabiliTrak button if both systems (traction control and StabiliTrak) were previously on.



To disable both TCS and StabiliTrak, press and hold the TCS/StabiliTrak button until the StabiliTrak OFF light illuminates and the appropriate DIC message displays. This will also disable the TSC feature.

Traction control and StabiliTrak can be turned on by pressing and releasing the TCS/StabiliTrak button if they are not automatically shut off for any other reason. This will also enable the TSC feature.

When the TCS or StabiliTrak system is turned off, the StabiliTrak light and the appropriate message will be displayed on the DIC to warn the driver. The vehicle will still have brake-traction control when traction control is off, but will not be able to use the engine speed management system. See “Traction Control Operation” next for more information.

When the TCS has been turned off, system noises may still be heard as a result of the brake-traction control coming on.

It is recommended to leave the system on for normal driving conditions, but it may be necessary to turn the system off if the vehicle is stuck in sand, mud, ice or snow, and you want to “rock” the vehicle to attempt to free it. It may also be necessary to turn off the system when driving in extreme off-road conditions where high wheel spin is required. See *If the Vehicle Is Stuck on page 9-14*.

When the transfer case is in 4LO, the stability system is automatically disabled, the StabiliTrak light comes on, and the appropriate message will appear on the DIC. Both traction control and StabiliTrak are automatically disabled in this condition.

### Traction Control Operation

The TCS is part of the StabiliTrak system. Traction control limits wheel spin by reducing engine power to the wheels (engine speed management) and by applying brakes to each individual wheel (brake-traction control) as necessary.

The TCS is enabled automatically when the vehicle is started. It will activate and the StabiliTrak light will flash if it senses that any of the wheels are spinning or beginning to lose traction while driving. If traction control is turned off, only the brake-traction control portion of traction control will work. The engine speed management will be



disabled. In this mode, engine power is not reduced automatically and the driven wheels can spin more freely. This can cause the brake-traction control to activate constantly.

**Notice: If the wheel(s) of one axle is allowed to spin excessively while the StabiliTrak<sup>®</sup>, ABS, brake warning lights, and any relevant DIC messages are displayed, the transfer case could be damaged. The repairs would not be covered by the vehicle warranty. Reduce engine power and do not spin the wheel(s) excessively while these lights and messages are displayed.**

The TCS may activate on dry or rough roads or under conditions such as heavy acceleration while turning or abrupt upshifts/downshifts of the transmission. When this happens, a reduction in acceleration may be noticed, or a noise or vibration may be heard. This is normal.

If cruise control is being used when the system activates, the StabiliTrak light will flash and cruise control will automatically disengage. Cruise control may be reengaged when road conditions allow. See *Cruise Control* on page 9-56.

StabiliTrak may also turn off automatically if it determines that a problem exists with the system. If the problem does not clear itself after restarting the vehicle, see your dealer for service.

Vehicles with StabiliTrak have a Trailer Sway Control (TSC) feature. See *Trailer Sway Control (TSC)* on page 9-100.

Vehicles with StabiliTrak have a Hill Start Assist (HSA) feature. See *Hill Start Assist (HSA)* on page 9-52.

Adding non-dealer accessories can affect the vehicle's performance. See *Accessories and Modifications* on page 10-3.

## Locking Rear Axle

Vehicles with a locking rear axle can give more traction on snow, mud, ice, sand, or gravel. It works like a standard axle most of the time, but when traction is low, this feature will allow the rear wheel with the most traction to move the vehicle.

### Cruise Control

#### WARNING

Cruise control can be dangerous where you cannot drive safely at a steady speed. So, do not use the cruise control on winding roads or in heavy traffic.

Cruise control can be dangerous on slippery roads. On such roads, fast changes in tire traction can cause excessive wheel slip, and you could lose control. Do not use cruise control on slippery roads.

For vehicles with cruise control, a speed of about 40 km/h (25 mph) or more can be maintained without keeping your foot on the accelerator. Cruise control does not work at speeds below about 40 km/h (25 mph).

When the brakes are applied, cruise control is turned off.

For vehicles with an Allison or Hydra-Matic 6-speed automatic transmission, see "Grade Braking" under *Tow/Haul Mode* on page 9-37 for an explanation of how cruise control interacts with the Range Selection Mode, tow/haul and grade braking systems.

For vehicles with the StabiliTrak system that begins to limit wheel spin while you are using cruise control, the cruise control will automatically disengage. See *StabiliTrak® System* on page 9-53. When road conditions allow the cruise control to be safely used again, it can be turned back on.

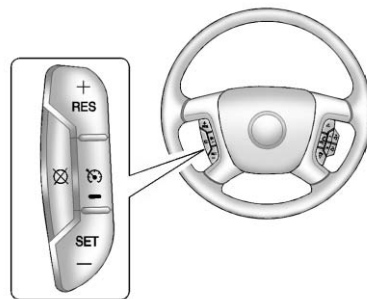

 **(On/Off):** Press to turn the system on or off. The indicator light is on when cruise control is on and turns off when cruise control is off.

**+ RES (Resume/Accelerate):** Press briefly to resume to a previously set speed, or press and hold to accelerate.

**SET - (Set/Coast):** Press to set the speed and activate cruise control or make the vehicle decelerate.

⊗ **(Cancel)**: Press to disengage cruise control without erasing the set speed from memory.

### Setting Cruise Control

If the cruise button is on when not in use, it could get bumped and go into cruise when not desired. Keep the cruise control switch off when cruise is not being used.

The cruise control light on the instrument panel cluster will come on after the cruise control has been set to the desired speed.

1. Press .
2. Get up to the desired speed.
3. Press the SET- button located on the steering wheel and release it.
4. Take your foot off the accelerator.

### Resuming a Set Speed

If the cruise control is set at a desired speed and then the brakes are applied, the cruise control is disengaged without erasing the set speed from memory.

Once the vehicle speed reaches about 40 km/h (25 mph) or more, press the +RES button on the steering wheel. The vehicle returns to the previous set speed and stays there.

### Increasing Speed While Using Cruise Control

If the cruise control system is already activated,

- Press and hold the +RES button on the steering wheel until the desired speed is reached, then release it.
- To increase vehicle speed in small amounts, press the +RES button. Each time this is done, the vehicle goes about 1.6 km/h (1 mph) faster.

### Reducing Speed While Using Cruise Control

If the cruise control system is already activated,

- Press and hold the SET- button on the steering wheel until the desired lower speed is reached, then release it.
- To slow down in small amounts, press the SET- button on the steering wheel briefly. Each time this is done, the vehicle goes about 1.6 km/h (1 mph) slower.

### Passing Another Vehicle While Using Cruise Control

Use the accelerator pedal to increase the vehicle speed. When you take your foot off the pedal, the vehicle will slow down to the previous set cruise speed.

### Using Cruise Control on Hills

How well the cruise control works on hills depends on the vehicle speed, the load, and the steepness of the hills. When going up steep hills, pressing the accelerator pedal may be necessary to maintain vehicle speed.

While going downhill:

- Vehicles with a four speed automatic transmission may need to have the brakes applied or the transmission shifted to a lower gear to maintain driver selected speed.
- Vehicles with a six speed automatic transmission and a gasoline engine have Cruise Grade Braking to help maintain driver selected speed.

Cruise Grade Braking is enabled when the vehicle is started and Cruise Control is active. It is not enabled in Range Selection Mode. It assists in maintaining driver selected speed when driving on downhill grades by using the engine and transmission to slow the vehicle.



To disable and enable Cruise Grade Braking for the current ignition key cycle, press and hold the Tow/Haul button for three seconds. A DIC message displays. See *Transmission Messages on page 5-44*.

- Vehicles with a diesel engine have Cruise Grade Braking enabled when Tow/Haul Mode is on, the exhaust brake is on, or both are on.

For other forms of Grade Braking, see *Automatic Transmission on page 9-32* and *Tow/Haul Mode on page 9-37*.

### Ending Cruise Control

There are three ways to end cruise control:

- To disengage cruise control; step lightly on the brake pedal.
- Press  on the steering wheel.
- To turn off the cruise control, press  on the steering wheel.

### Erasing Speed Memory

The cruise control set speed is erased from memory by pressing  or if the ignition is turned off.

## Object Detection Systems

### Ultrasonic Parking Assist

If available, the Ultrasonic Rear Parking Assist (URPA) system assists the driver with parking and avoiding objects while in R (Reverse). URPA operates at speeds less than 8 km/h (5 mph). The sensors on the rear bumper detect objects up to 2.5 m (8 ft) behind the vehicle, and at least 25 cm (10 in) off the ground.

#### WARNING

The URPA system does not detect children, pedestrians, bicyclists, animals, or objects below the bumper or that are too close or too far from the vehicle. It is not available at speeds greater than 8 km/h (5 mph). To prevent injury, death, or vehicle

(Continued)

#### WARNING (Continued)

damage, even with URPA, always check the area around the vehicle and check all mirrors before backing.

### How the System Works

URPA comes on automatically when the shift lever is moved into R (Reverse). A single tone sounds to indicate the system is working.

URPA operates only at speeds less than 8 km/h (5 mph).

An obstacle is indicated by audible beeps. The interval between the beeps becomes shorter as the vehicle gets closer to the obstacle. When the distance is less than 30 cm (12 in) the beeping is a continuous tone for five seconds.

To be detected, objects must be at least 25 cm (10 in) off the ground and below tailgate level. Objects must also be within 2.5 m (8 ft) from

the rear bumper. This distance may be less during warmer or humid weather.

### Turning the System On and Off

The URPA system can be turned on and off using the rear park aid disable button located next to the radio.



The indicator light comes on when the system is disabled and turns off when the system is on.

When the system is off, PARK ASSIST OFF displays on the Driver Information Center (DIC). The message disappears after a short period of time.

URPA defaults to the on setting each time the vehicle is started.

**Notice:** If you use URPA while the tailgate is lowered, it may not detect an object behind your vehicle, and you might back into the object and damage your vehicle. Always verify the tailgate is closed when using URPA or turn off URPA when driving with the tailgate lowered.

### When the System Does Not Seem to Work Properly

The following messages may be displayed on the DIC:

**SERVICE PARK ASSIST:** If this message occurs, take the vehicle to your dealer to repair the system.

### PARK ASST BLOCKED SEE

**OWNERS MANUAL:** This message can occur under the following conditions:

- The ultrasonic sensors are not clean. Keep the vehicle's rear bumper free of mud, dirt, snow, ice, and slush. For cleaning instructions, see *Exterior Care on page 10-91*.

- The park assist sensors are covered by frost or ice. Frost or ice can form around and behind the sensors and may not always be seen; this can occur after washing the vehicle in cold weather. The message may not clear until the frost or ice has melted.
- A trailer was attached to the vehicle, or an object was hanging out of the tailgate during the last drive cycle. Once the object is removed and the tailgate is raised, URPA will return to normal operation.
- A tow bar is attached to the vehicle.
- The bumper is damaged. Take the vehicle to your dealer to repair the system.
- Other conditions, such as vibrations from a jackhammer or the compression of air brakes on a very large truck, are affecting system performance.

## Rear Vision Camera (RVC)

If available, the Rear Vision Camera (RVC) system displays part of the scene behind the vehicle.

### WARNING

The RVC system does not display children, pedestrians, bicyclists, animals, or any other object located outside the camera's field of view, below the bumper, or under the vehicle. Perceived distances may be different from actual distances. Do not back the vehicle using only the RVC screen, during longer, higher speed backing maneuvers, or where there could be cross traffic. Failure to use proper care before backing may result in injury, death, or vehicle damage. Always check behind and around the vehicle before backing.

## Vehicles without Navigation System

The RVC system displays a view of the area behind the vehicle. When the vehicle is on and shifted into R (Reverse) the video image appears on the inside rearview mirror. The video image disappears after the vehicle is shifted out of R (Reverse).

### Turning the RVC System On or Off

To turn off the RVC system, press and hold , located on the inside rearview mirror, until the left indicator light turns off. The RVC display is now disabled.

To turn the RVC system on, press and hold  until the left indicator light comes on. The RVC system display will appear in the mirror.

## Vehicles with Navigation System

The RVC system is designed to help the driver when backing up by displaying a view of the area behind

the vehicle. When the vehicle is shifted into R (Reverse), the video image appears on the navigation screen. After a delay, the navigation screen displays the last screen after the vehicle is shifted out of R (Reverse).

### Turning the RVC System On or Off

To turn the RVC system on or off:

1. Shift into P (Park).
2. Press MENU to enter the configure menu options. Turn the Multifunction knob until the Display feature is highlighted and press the Multifunction knob. Or press the Display screen button
3. Select the Rear Camera Options screen button. The Rear Camera Options screen displays.
4. Select the Video screen button. When the Video screen button is highlighted the RVC system is on.

The delay after shifting out of R (Reverse) is approximately 10 seconds. The delay can be canceled by performing one of the following:

- Pressing a hard key on the navigation system.
- Shifting into P (Park).
- Reaching a vehicle speed of 8 km/h (5 mph).

### Symbols

The navigation system may have a feature that allows for viewing parking assist symbols on the navigation screen while using the RVC. The Ultrasonic Rear Park Assist (URPA) system must not be disabled to use the caution symbols. If URPA has been disabled and the symbols have been turned on, the Rear Parking Assist Symbols Unavailable error message may display. See *Ultrasonic Parking Assist* on page 9-59.

## 9-62 Driving and Operating

---

The symbols appear near objects detected by the URPA system. The symbol may cover the object when viewing the navigation screen.

To turn the symbols on or off:

1. Make sure that URPA has not been disabled.
2. Shift into P (Park).
3. Press MENU to enter the configure menu options. Turn the Multifunction knob until the Display feature is highlighted and press the Multifunction knob. Or press the Display screen button
4. Select the Rear Camera Options screen button. The Rear Camera Options screen displays.
5. Touch the Symbols screen button. The screen button will be highlighted when on.

### Guidelines

The RVC system has a guideline overlay that can help the driver align the vehicle when backing into a parking spot.

If the vehicle has dual rear wheels, this feature will not be available.

To turn the guidelines on or off:

1. Make sure that URPA has not been disabled.
2. Shift into P (Park).
3. Press MENU to enter the configure menu options. Turn the Multifunction knob until the Display feature is highlighted and press the Multifunction knob. Or press the Display screen button
4. Select the Rear Camera Options screen button. The Rear Camera Options screen displays.
5. Touch the Guidelines screen button. The screen button will be highlighted when on.

### RVC Location

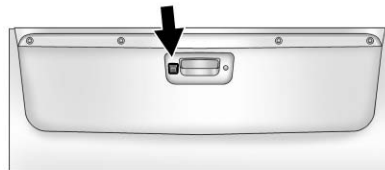

The camera is near the tailgate handle.

This shows the field of view that the camera provides.



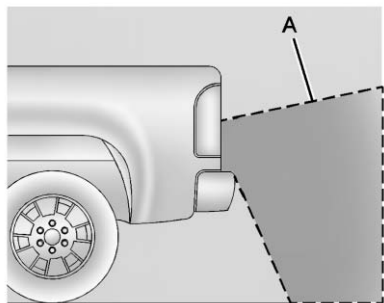

A. View displayed by the camera

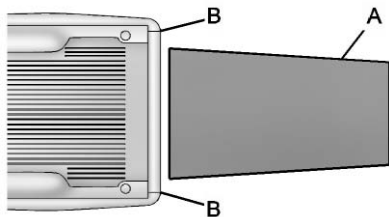

A. View displayed by the camera  
B. Corners of the rear bumper

Displayed images may be further or closer than they appear. The area displayed is limited and objects which are close to either corner of the bumper or under the bumper do not display.

### Disconnecting the RVC

The rear vision camera must be disconnected if the tailgate needs to be removed.

To disconnect the camera:

1. Remove the license plate.
2. Disconnect the camera connectors from the chassis harness, located behind the license plate, by pressing on the release tab on each connector.

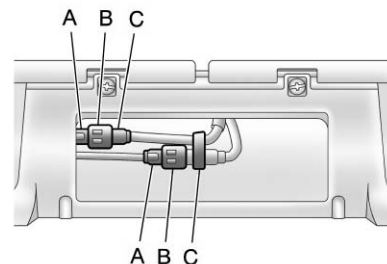

- A. Chassis harness connector
  - B. Release tab
  - C. Camera connector
3. Plug the two exposed chassis harness connectors together to prevent contamination.

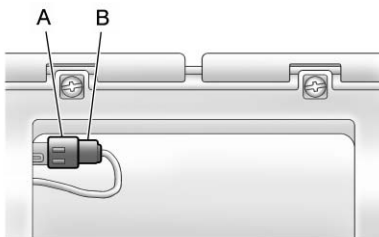

A. Chassis harness connector

B. Release tab

4. Feed the wiring harness through the pickup box, then plug the camera connectors together to prevent contamination.
5. Remove the tailgate. See *Tailgate* on page 2-9 for more information.
6. Reinstall the license plate.

Reverse this procedure to reinstall the RVC and make sure the grommet and connection are secure.

### When the System Does Not Seem To Work Properly

The RVC system might not work properly or display a clear image if:

- The RVC is turned off. See “Turning the RVC System On or Off” earlier in this section.
- It is dark.
- The sun or the beam of headlamps is shining directly into the camera lens.
- Ice, snow, mud, or anything else builds up on the camera lens. Clean the lens, rinse it with water, and wipe it with a soft cloth.
- The back of the vehicle is in an accident, the position and mounting angle of the camera can change or the camera can be affected. Be sure to have the camera and its position and mounting angle checked at your dealer.

The RVC system display in the rearview mirror may turn off or not appear as expected due to one of the following conditions. If this occurs the left indicator light on the mirror will flash.

- A slow flash may indicate a loss of video signal, or no video signal present during the reverse cycle.
- A fast flash may indicate that the display has been on for the maximum allowable time during a reverse cycle, or the display has reached an Over Temperature limit.

The fast flash conditions are used to protect the video device from high temperature conditions. Once conditions return to normal the device will reset and the green indicator will stop flashing.

During any of these fault conditions, the display will be blank and the indicator will flash while the vehicle is in R (Reverse) or until the conditions return to normal.

Press and hold  when the left indicator light is flashing to turn off the video display along with the left indicator light.

## Fuel

For diesel engine vehicles, see “Fuel for Diesel Engines” in the Duramax Diesel Supplement.

For Vehicles with gasoline engines, please read this.

### Gasoline

Use of the recommended fuel is an important part of the proper maintenance of this vehicle. To help keep the engine clean and maintain optimum vehicle performance, we recommend the use of gasoline advertised as TOP TIER Detergent Gasoline.

Look for the TOP TIER label on the fuel pump to ensure gasoline meets enhanced detergency standards developed by auto companies. A list of marketers providing TOP TIER Detergent Gasoline can be found at [www.toptiergas.com](http://www.toptiergas.com). TOP TIER gasoline is only available in the U.S. and Canada.



The eighth digit of the Vehicle Identification Number (VIN) shows the code letter or number that identifies the vehicle's engine. The VIN is at the top left of the instrument panel. See *Vehicle Identification Number (VIN)* on page 12-1.

Vehicles that have a yellow fuel cap can use either unleaded gasoline or ethanol fuel containing up to 85% ethanol (E85). See *Fuel E85 (85% Ethanol)* on page 9-68. For all other vehicles, use only the unleaded gasoline described under *Recommended Fuel* on page 9-66.

### Recommended Fuel

For all vehicles except those with the 6.2L V8 engine (VIN Code 2), use regular unleaded gasoline with a posted octane rating of 87 or higher. If the octane rating is less than 87, an audible knocking noise, commonly referred to as spark knock, might be heard when driving. If this occurs, use a gasoline rated at 87 octane or higher as soon as possible. If heavy knocking is heard when using gasoline rated at 87 octane or higher, the engine needs service.

If the vehicle has the 6.2L V8 engine (VIN Code 2), use premium unleaded gasoline with a posted octane rating of 91 or higher. You can also use regular unleaded gasoline rated at 87 octane or higher, but the vehicle's acceleration could be slightly reduced, and a slight audible knocking noise, commonly referred to as spark knock, might be heard. If the octane is less than 87, you might notice a

heavy knocking noise when you drive. If this occurs, use a gasoline rated at 87 octane or higher as soon as possible. Otherwise, you could damage the engine. If heavy knocking is heard when using gasoline rated at 87 octane or higher, the engine needs service.

### Gasoline Specifications

At a minimum, gasoline should meet ASTM specification D 4814. Some gasolines contain an octane-enhancing additive called methylcyclopentadienyl manganese tricarbonyl (MMT). We recommend against the use of gasolines containing MMT. See *Fuel Additives on page 9-67*.

### California Fuel Requirements

If the vehicle is certified to meet California Emissions Standards, it is designed to operate on fuels that meet California specifications. See the underhood emission control

label. If this fuel is not available in states adopting California Emissions Standards, the vehicle will operate satisfactorily on fuels meeting federal specifications, but emission control system performance might be affected. The malfunction indicator lamp could turn on and the vehicle might fail a smog-check test. See *Malfunction Indicator Lamp on page 5-21*. If this occurs, return to your authorized dealer for diagnosis. If it is determined that the condition is caused by the type of fuel used, repairs might not be covered by the vehicle warranty.

### Fuels in Foreign Countries

Never use leaded gasoline or any other fuel not recommended in the previous text on fuel. Costly repairs caused by use of improper fuel would not be covered by the vehicle warranty.

To check the fuel availability, ask an auto club, or contact a major oil company that does business in the country where you will be driving.

## Fuel Additives

To provide cleaner air, all gasolines in the United States are now required to contain additives that help prevent engine and fuel system deposits from forming, allowing the emission control system to work properly. In most cases, nothing should have to be added to the fuel. However, some gasolines contain only the minimum amount of additive required to meet U.S. Environmental Protection Agency regulations. To help keep fuel injectors and intake valves clean and avoid problems due to dirty injectors or valves, look for gasoline that is advertised as TOP TIER Detergent Gasoline. Look for the TOP TIER label on the fuel pump to ensure gasoline meets enhanced detergency standards developed by the auto companies. A list of

marketers providing TOP TIER Detergent Gasoline can be found at [www.toptiergas.com](http://www.toptiergas.com).

For customers who do not use TOP TIER Detergent Gasoline regularly, one bottle of GM Fuel System Treatment PLUS, added to the fuel tank at every engine oil change, can help clean deposits from fuel injectors and intake valves. GM Fuel System Treatment PLUS is the only gasoline additive recommended by General Motors. It is available at your dealer.

Gasolines containing oxygenates, such as ethers and ethanol, and reformulated gasolines might be available in your area. We recommend that you use these gasolines, if they comply with the specifications described earlier. However, E85 (85% ethanol) and other fuels containing more than 15% ethanol must not be used in vehicles that were not designed for those fuels.

***Notice:*** This vehicle was not designed for fuel that contains methanol. Do not use fuel containing methanol. It can corrode metal parts in the fuel system and also damage plastic and rubber parts. That damage would not be covered under the vehicle warranty.

Some gasolines that are not reformulated for low emissions can contain an octane-enhancing additive called methylcyclopentadienyl manganese tricarbonyl (MMT); ask the attendant where you buy gasoline whether the fuel contains MMT. We recommend against the use of such gasolines. Fuels containing MMT can reduce spark plug life and affect emission control system performance. The malfunction indicator lamp might turn on. If this occurs, return to your dealer for service.

### Fuel E85 (85% Ethanol)

Vehicles that have a yellow fuel cap can use either unleaded gasoline or ethanol fuel containing up to 85% ethanol (E85). For all other vehicles, use only the unleaded gasoline described under *Recommended Fuel* on page 9-66.

We encourage the use of E85 in vehicles that are designed to use it. The ethanol in E85 is a “renewable” fuel, meaning it is made from renewable sources such as corn and other crops.

Many service stations will not have an 85% ethanol fuel (E85) pump available. The U.S. Department of Energy has an alternative fuels website ([www.afdc.energy.gov/afdc/locator/stations/](http://www.afdc.energy.gov/afdc/locator/stations/)) that can help you find E85 fuel. Those stations that do have E85 should have a label indicating ethanol content. Do not use the fuel if the ethanol content is greater than 85%.

At a minimum, E85 should meet ASTM Specification D 5798 or CGSB Specification 3.512. Filling the tank with fuel mixtures that do not meet ASTM or CGSB specifications can affect driveability and could cause the malfunction indicator lamp to come on. As the outside temperature approaches freezing, ethanol fuel distributors should supply winter grade ethanol, the same as with unleaded gasoline.

It is best not to alternate repeatedly between gasoline and E85. If you do switch fuels, it is recommended that you add as much fuel as possible — do not add less than 11 L (3 gal) when refueling. You should drive the vehicle immediately after refueling for at least 11 km (7 mi) to allow the vehicle to adapt to the change in ethanol concentration.

E85 has less energy per liter (gallon) than gasoline, so you will need to refill the fuel tank more

often when using E85 than when you are using gasoline. See *Filling the Tank* on page 9-68.

**Notice:** Some additives are not compatible with E85 fuel and can harm the vehicle's fuel system. Do not add anything to E85. Damage caused by additives would not be covered by the vehicle warranty.

**Notice:** This vehicle was not designed for fuel that contains methanol. Do not use fuel containing methanol. It can corrode metal parts in the fuel system and also damage plastic and rubber parts. That damage would not be covered under the vehicle warranty.

### Filling the Tank

If the vehicle has a diesel engine, see the Duramax diesel supplement for more information.

 **WARNING**

Fuel vapors and fuel fires burn violently and can cause injury or death.

- To help avoid injuries to you and others, read and follow all the instructions on the fuel pump island.
- Turn off the engine when refueling.
- Keep sparks, flames, and smoking materials away from fuel.
- Do not leave the fuel pump unattended.
- Do not reenter the vehicle while pumping fuel.
- Keep children away from the fuel pump and never let children pump fuel.

(Continued)

**WARNING (Continued)**

- Fuel can spray out if the fuel cap is opened too quickly. This spray can happen if the tank is nearly full, and is more likely in hot weather. Open the fuel cap slowly and wait for any hiss noise to stop then unscrew the cap all the way

The tethered fuel cap is located behind a hinged fuel door on the driver side of the vehicle. Vehicles that have a FlexFuel badge and a yellow fuel cap can use either unleaded gasoline or ethanol fuel containing up to 85% ethanol (E85). See *Fuel E85 (85% Ethanol)* on page 9-68.

To remove the fuel cap, turn it slowly counterclockwise.

If the vehicle is a dual fuel tank chassis cab model, and it runs out of fuel, refuel the front fuel tank first to ensure a quick restart.

Be careful not to spill fuel. Do not top off or overfill the tank and wait a few seconds after you have finished pumping before removing the nozzle. Clean fuel from painted surfaces as soon as possible. See *Exterior Care* on page 10-91.

When replacing the fuel cap, turn it clockwise until it clicks. It will require more effort to turn the fuel cap on the last turn as you tighten it. Make sure the cap is fully installed. The diagnostic system can determine if the fuel cap has been left off or improperly installed. This would allow fuel to evaporate into the atmosphere. See *Malfunction Indicator Lamp* on page 5-21.

The TIGHTEN GAS CAP message displays on the Driver Information Center (DIC) if the fuel cap is not properly installed. See *Fuel System Messages* on page 5-41 for more information.

 **WARNING**

If a fire starts while you are refueling, do not remove the nozzle. Shut off the flow of fuel by shutting off the pump or by notifying the station attendant. Leave the area immediately.

**Notice:** If a new fuel cap is needed, be sure to get the right type of cap from your dealer. The wrong type of fuel cap might not fit properly, might cause the malfunction indicator lamp to light, and could damage the fuel tank and emissions system. See *Malfunction Indicator Lamp* on page 5-21.

## Filling a Portable Fuel Container

 **WARNING**

Filling a portable fuel container while it is in the vehicle can cause fuel vapors that can ignite either by static electricity or other means. You or others could be badly burned and the vehicle could be damaged. Always:

- Use approved fuel containers.
- Remove container from vehicle, trunk, or pickup bed before filling.

(Continued)

**WARNING (Continued)**

- Place container on the ground.
- Place the nozzle inside the fill opening of the container before dispensing fuel, and keep it in contact with the fill opening until filling is complete.
- Do not smoke while pumping fuel.



## Towing

### General Towing Information

Only use towing equipment that has been designed for the vehicle. Contact your dealer or trailering dealer for assistance with preparing the vehicle for towing a trailer. Read the entire section before towing a trailer.

For towing a disabled vehicle, see *Towing the Vehicle on page 10-87*. For towing the vehicle behind another vehicle such as a motor home, see *Recreational Vehicle Towing on page 10-87*.

### Driving Characteristics and Towing Tips

#### Driving with a Trailer

When towing a trailer:

- Become familiar with the state and local laws that apply to trailer towing.

- Do not tow a trailer during the first 800 km (500 mi) to prevent damage to the engine, axle, or other parts.
- Then during the first 800 km (500 mi) of trailer towing, do not drive over 80 km/h (50 mph) and do not make starts at full throttle.
- Vehicles can tow in D (Drive). Shift the transmission to a lower gear if the transmission shifts too often under heavy loads and/or hilly conditions.

#### WARNING

When towing a trailer, exhaust gases may collect at the rear of the vehicle and enter if the liftgate, trunk/hatch, or rear-most window is open.

When towing a trailer:

- Do not drive with the liftgate, trunk/hatch, or rear-most window open.

(Continued)

#### WARNING (Continued)

- Fully open the air outlets on or under the instrument panel.
- Also adjust the climate control system to a setting that brings in only outside air. See "Climate Control System" in the Index.

For more information about Carbon Monoxide, see *Engine Exhaust on page 9-31*.

Towing a trailer requires a certain amount of experience. The combination you are driving is longer and not as responsive as the vehicle itself. Get acquainted with the handling and braking of the rig before setting out for the open road.

Before starting, check all trailer hitch parts and attachments, safety chains, electrical connectors, lamps, tires, and mirrors. If the trailer has electric brakes, start the

combination moving and then apply the trailer brake controller by hand to be sure the brakes work.

During the trip, check occasionally to be sure that the load is secure and the lamps and any trailer brakes still work.

### Following Distance

Stay at least twice as far behind the vehicle ahead as you would when driving the vehicle without a trailer. This can help to avoid heavy braking and sudden turns.

### Passing

More passing distance is needed when towing a trailer. The combination will not accelerate as quickly and is longer so it is necessary to go much farther beyond the passed vehicle before returning to the lane.

### Backing Up

Hold the bottom of the steering wheel with one hand. To move the trailer to the left, move that hand to

the left. To move the trailer to the right, move your hand to the right. Always back up slowly and, if possible, have someone guide you.

### Making Turns

**Notice:** Making very sharp turns while trailering could cause the trailer to come in contact with the vehicle. The vehicle could be damaged. Avoid making very sharp turns while trailering.

When turning with a trailer, make wider turns than normal. Do this so the trailer will not strike soft shoulders, curbs, road signs, trees, or other objects. Avoid jerky or sudden maneuvers. Signal well in advance.

If the trailer turn signal bulbs burn out, the arrows on the instrument cluster will still flash for turns. It is important to check occasionally to be sure the trailer bulbs are still working.

### Driving on Grades

Reduce speed and shift to a lower gear *before* starting down a long or steep downgrade. If the transmission is not shifted down, the brakes might get hot and no longer work well.

Vehicles can tow in D (Drive). Shift the transmission to a lower gear if the transmission shifts too often under heavy loads and/or hilly conditions.

The Tow/Haul Mode may be used if the transmission shifts too often. See *Tow/Haul Mode on page 9-37*.

When towing at high altitude on steep uphill grades, consider the following: Engine coolant will boil at a lower temperature than at normal altitudes. If the engine is turned off immediately after towing at high altitude on steep uphill grades, the vehicle may show signs similar to engine overheating. To avoid this, let the engine run while parked, preferably on level ground, with the automatic transmission in P (Park)

for a few minutes before turning the engine off. If the overheat warning comes on, see *Engine Overheating on page 10-20*.

### Parking on Hills

 **WARNING**

Parking the vehicle on a hill with the trailer attached can be dangerous. If something goes wrong, the rig could start to move. People can be injured, and both the vehicle and the trailer can be damaged. When possible, always park the rig on a flat surface.

If parking the rig on a hill:

1. Press the brake pedal, but do not shift into P (Park) yet. Turn the wheels into the curb if facing downhill or into traffic if facing uphill.
2. Have someone place chocks under the trailer wheels.

3. When the wheel chocks are in place, release the regular brakes until the chocks absorb the load.
4. Reapply the brake pedal. Then apply the parking brake and shift into P (Park).
5. Release the brake pedal.

### Leaving After Parking on a Hill

1. Apply and hold the brake pedal.
2. Start the engine.
3. Shift into a gear.
4. Release the parking brake.
5. Let up on the brake pedal.
6. Drive slowly until the trailer is clear of the chocks.
7. Stop and have someone pick up and store the chocks.

### Maintenance when Trailer Towing

The vehicle needs service more often when pulling a trailer. See *Maintenance Schedule on page 11-3*. Things that are

especially important in trailer operation are automatic transmission fluid, engine oil, axle lubricant, belts, cooling system, and brake system. It is a good idea to inspect these before and during the trip.

Check periodically to see that all hitch nuts and bolts are tight.

### Trailer Towing

If the vehicle has a diesel engine, see the Duramax diesel supplement for more information.

If the vehicle is a hybrid, see the hybrid supplement for more information.

If the vehicle is bi-fuel, see the bi-fuel supplement for more information.

Do not tow a trailer during break-in. See *New Vehicle Break-In on page 9-23* for more information.

### **WARNING**

The driver can lose control when pulling a trailer if the correct equipment is not used or the vehicle is not driven properly. For example, if the trailer is too heavy, the brakes may not work well or even at all. The driver and passengers could be seriously injured. The vehicle may also be damaged; the resulting repairs would not be covered by the vehicle warranty. Pull a trailer only if all the steps in this section have been followed. Ask your dealer for advice and information about towing a trailer with the vehicle.

**Notice:** Pulling a trailer improperly can damage the vehicle and result in costly repairs not covered by the vehicle warranty. To pull a trailer correctly, follow the advice in this

**section and see your dealer for important information about towing a trailer with the vehicle.**

To identify the trailering capacity of the vehicle, read the information in “Weight of the Trailer” later in this section.

Trailering is different than just driving the vehicle by itself.

Trailering means changes in handling, acceleration, braking, durability, and fuel economy. Successful, safe trailering takes correct equipment, and it has to be used properly.

The following information has many time-tested, important trailering tips and safety rules. Many of these are important for your safety and that of your passengers. So please read this section carefully before pulling a trailer.

### **Weight of the Trailer**

How heavy can a trailer safely be?

It depends on how the rig is used. Speed, altitude, road grades, outside temperature, and how much the vehicle is used to pull a trailer are all important. It can depend on any special equipment on the vehicle, and the amount of tongue weight the vehicle can carry. See “Weight of the Trailer Tongue” later in this section for more information.

Trailer weight rating (TWR) is calculated assuming the tow vehicle has only the driver but all required trailering equipment. Weight of additional optional equipment, passengers, and cargo in the tow vehicle must be subtracted from the trailer weight rating.

For kingpin weight and trailer tongue weight information, see “Weight of the Trailer Tongue” later in this section.

Use the following chart to determine how much the vehicle can weigh, based upon the vehicle model and options.

Weights listed apply for conventional trailers and fifth-wheel trailers unless otherwise noted.

<b>Vehicle</b>	<b>Axle Ratio</b>	<b>Maximum Trailer Weight</b>	<b>GCWR (a)</b>
<b>1500 Series 2WD Regular Cab Standard Box</b>			
4.3L V6 (b)	3.23	2 177 kg (4,800 lbs)	4 309 kg (9,500 lbs)
4.3L V6 — With Automatic Transmission (b)	3.73	2 449 kg (5,400 lbs)	4 536 kg (10,000 lbs)
4.3L V6 — With Manual Transmission (b)	3.73	1 860 kg (4,100 lbs)	3 938 kg (8,683 lbs)
4.8L V8 (b)	3.23	2 132 kg (4,700 lbs)	4 309 kg (9,500 lbs)
4.8L V8 (b)	3.73	3 266 kg (7,200 lbs)	5 443 kg (12,000 lbs)
5.3L LMG V8 (b)	3.08	2 994 kg (6,600 lbs)	5 216 kg (11,500 lbs)
5.3L LMG V8, K5L HD Cooling Pkg	3.08	3 357 kg (7,400 lbs)	5 534 kg (12,200 lbs)
5.3L LMG V8 K5L HD Cooling Pkg	3.42	4 128 kg (9,100 lbs)	6 350 kg (14,000 lbs)
<b>1500 Series 2WD Extended Cab Standard Box</b>			
4.3L V6 (b)	3.23	1 996 kg (4,400 lbs)	4 309 kg (9,500 lbs)
4.8L V8 (b)	3.23	2 132 kg (4,700 lbs)	4 536 kg (10,000 lbs)
4.8L V8 (b)	3.73	3 039 kg (6,700 lbs)	5 443 kg (12,000 lbs)
5.3L V8 (b)	3.08	2 812 kg (6,200 lbs)	5 216 kg (11,500 lbs)

**9-76 Driving and Operating**

<b>Vehicle</b>	<b>Axle Ratio</b>	<b>Maximum Trailer Weight</b>	<b>GCWR (a)</b>
5.3L V8 K5L HD Cooling Pkg (b)	3.08	3 130 kg (6,900 lbs)	5 534 kg (12,200 lbs)
5.3L V8 K5L HD Cooling Pkg — Conventional Trailer	3.42	4 400 kg (9,700 lbs)	6 804 kg (15,000 lbs)
5.3L V8 K5L HD Cooling Pkg — Fifth-Wheel Trailer	3.42	4 264 kg (9,400 lbs)	6 804 kg (15,000 lbs)
6.2L V8 K5L HD Cooling Pkg — Conventional Trailer	3.42	4 400 kg (9,700 lbs)	6 804 kg (15,000 lbs)
6.2L V8 K5L HD Cooling Pkg — Fifth-Wheel Trailer	3.42	4 264 kg (9,400 lbs)	6 804 kg (15,000 lbs)
6.2L V8 NHT Max Trailering Pkg — Conventional Trailer	3.73	4 853 kg (10,700 lbs)	7 257 kg (16,000 lbs)
6.2L V8 NHT Max Trailering Pkg — Fifth-Wheel Trailer	3.73	4 808 kg (10,600 lbs)	7 257 kg (16,000 lbs)
<b>1500 Series 2WD Crew Cab Short Box (b)</b>			
4.8L V8	3.23	2 132 kg (4,700 lbs)	4 536 kg (10,000 lbs)
4.8L V8	3.73	3 039 kg (6,700 lbs)	5 443 kg (12,000 lbs)
5.3L V8 (LMG)	3.08	2 812 kg (6,200 lbs)	5 216 kg (11,500 lbs)
5.3L V8 (LMG) K5L HD Cooling Pkg	3.08	3 130 kg (6,900 lbs)	5 534 kg (12,200 lbs)

<b>Vehicle</b>	<b>Axle Ratio</b>	<b>Maximum Trailer Weight</b>	<b>GCWR (a)</b>
5.3LV8 (LC9) XFE	3.08	3 175 kg (7,000 lbs)	5 534 kg (12,200 lbs)
5.3LV8 (LMG) K5L HD Cooling Pkg	3.42	4 355 kg (9,600 lbs)	6 804 kg (15,000 lbs)
6.2LV8 K5L HD Cooling Pkg	3.42	4 400 kg (9,700 lbs)	6 804 kg (15,000 lbs)
6.2LV8 NHT Max Trailering Pkg	3.73	4 808 kg (10,600 lbs)	7 257 kg (16,000 lbs)
<b>1500 Series 2WD Regular Cab Long Box</b>			
4.3LV6 (b)	3.23	2 132 kg (4,700 lbs)	4 309 kg (9,500 lbs)
4.3LV6 (b)	3.73	2 359 kg (5,200 lbs)	4 536 kg (10,000 lbs)
4.8LV8 (b)	3.23	2 313 kg (5,100 lbs)	4 536 kg (10,000 lbs)
4.8LV8 (b)	3.73	3 221 kg (7,100 lbs)	5 443 kg (12,000 lbs)
5.3LV8	3.08	2 948 kg (6,500 lbs)	5 216 kg (11,500 lbs)
5.3LV8 K5L HD Cooling Pkg	3.08	3 266 kg (7,200 lbs)	5 534 kg (12,200 lbs)
5.3LV8 K5L HD Cooling Pkg — Conventional Trailer	3.42	4 536 kg (10,000 lbs)	6 804 kg (15,000 lbs)
5.3LV8 K5L HD Cooling Pkg — Fifth-Wheel Trailer	3.42	4 037 kg (8,900 lbs)	6 804 kg (15,000 lbs)

**9-78 Driving and Operating**

---

<b>Vehicle</b>	<b>Axle Ratio</b>	<b>Maximum Trailer Weight</b>	<b>GCWR (a)</b>
<b>1500 Series 2WD Extended Cab Long Box</b>			
5.3LV8 (b)	3.08	2 722 kg (6,000 lbs)	5 216 kg (11,500 lbs)
5.3LV8 K5L HD Cooling Pkg (b)	3.08	3 039 kg (6,700 lbs)	5 534 kg (12,200 lbs)
5.3LV8 K5L HD Cooling Pkg — Conventional Trailer	3.42	4 309 kg (9,500 lbs)	6 804 kg (15,000 lbs)
5.3LV8 K5L HD Cooling Pkg — Fifth-Wheel Trailer	3.42	4 082 kg (9,000 lbs)	6 804 kg (15,000 lbs)
<b>1500 Series 4WD Regular Cab Standard Box</b>			
4.3LV6 (b)	3.73	2 313 kg (5,100 lbs)	4 536 kg (10,000 lbs)
4.8LV8 (b)	3.42	2 722 kg (6,000 lbs)	4 990 kg (11,000 lbs)
5.3LV8 (b)	3.08	2 903 kg (6,400 lbs)	5 216 kg (11,500 lbs)
5.3LV8 K5L HD Cooling Pkg	3.08	3 221 kg (7,100 lbs)	5 534 kg (12,200 lbs)
5.3LV8 K5L HD Cooling Pkg — Conventional Trailer	3.42	4 037 kg (8,900 lbs)	6 350 kg (14,000 lbs)
5.3LV8 K5L HD Cooling Pkg — Fifth-Wheel Trailer	3.42	3 719 kg (8,200 lbs)	6 350 kg (14,000 lbs)



<b>Vehicle</b>	<b>Axle Ratio</b>	<b>Maximum Trailer Weight</b>	<b>GCWR (a)</b>
<b>1500 Series 4WD Extended Cab Standard Box</b>			
4.8L V8 (b)	3.42	2 495 kg (5,500 lbs)	4 990 kg (11,000 lbs)
5.3L V8 (b)	3.08	2 767 kg (6,100 lbs)	5 216 kg (11,500 lbs)
5.3L V8 K5L HD Cooling Pkg (b)	3.08	3 084 kg (6,800 lbs)	5 534 kg (12,200 lbs)
5.3L V8 K5L HD Cooling Pkg — Conventional Trailer	3.42	4 354 kg (9,600 lbs)	6 804 kg (15,000 lbs)
5.3L V8 K5L HD Cooling Pkg — Fifth-Wheel Trailer	3.42	4 354 kg (9,600 lbs)	6 804 kg (15,000 lbs)
6.2L V8 K5L HD Cooling Pkg — Conventional Trailer	3.42	4 264 kg (9,400 lbs)	6 804 kg (15,000 lbs)
6.2L V8 K5L HD Cooling Pkg — Fifth-Wheel Trailer	3.42	4 128 kg (9,100 lbs)	6 804 kg (15,000 lbs)
6.2L V8 NHT Max Trailering Pkg — Conventional Trailer	3.73	4 717 kg (10,400 lbs)	7 257 kg (16,000 lbs)
6.2L V8 NHT Max Trailering Pkg — Fifth-Wheel Trailer	3.73	4 672 kg (10,300 lbs)	7 257 kg (16,000 lbs)
<b>1500 Series 4WD Crew Cab Short Box (b)</b>			
4.8L V8	3.42	2 495 kg (5,500 lbs)	4 990 kg (11,000 lbs)
5.3L V8	3.08	2 722 kg (6,000 lbs)	5 216 kg (11,500 lbs)

**9-80 Driving and Operating**

<b>Vehicle</b>	<b>Axle Ratio</b>	<b>Maximum Trailer Weight</b>	<b>GCWR (a)</b>
5.3L V8 K5L HD Cooling Pkg	3.08	3 039 kg (6,700 lbs)	5 534 kg (12,200 lbs)
5.3L V8 K5L HD Cooling Pkg	3.42	4 309 kg (9,500 lbs)	6 804 kg (15,000 lbs)
6.2L V8 K5L HD Cooling Pkg	3.42	4 264 kg (9,400 lbs)	6 804 kg (15,000 lbs)
6.2L V8 NHT Max Trailering Pkg	3.73	4 717 kg (10,400 lbs)	7 257 kg (16,000 lbs)
<b>1500 Series 4WD Regular Cab Long Box</b>			
4.3L V6 (b)	3.73	2 223 kg (4,900 lbs)	4 536 kg (10,000 lbs)
4.8L V8 (b)	3.42	2 631 kg (5,800 lbs)	4 990 kg (11,000 lbs)
5.3L V8 (b)	3.08	2 858 kg (6,300 lbs)	5 216 kg (11,500 lbs)
5.3L V8 K5L HD Cooling Pkg	3.08	3 175 kg (7,000 lbs)	5 534 kg (12,200 lbs)
5.3L V8 K5L HD Cooling Pkg — Conventional Trailer	3.42	4 445 kg (9,800 lbs)	6 804 kg (15,000 lbs)
5.3L V8 K5L HD Cooling Pkg — Fifth-Wheel Trailer	3.42	4 400 kg (9,700 lbs)	6 804 kg (15,000 lbs)
<b>1500 Series 4WD Extended Cab Long Box</b>			
5.3L V8 (b)	3.08	2 631 kg (5,800 lbs)	5 216 kg (11,500 lbs)
5.3L V8 K5L HD Cooling Pkg (b)	3.08	2 948 kg (6,500 lbs)	5 534 kg (12,200 lbs)
5.3L V8 K5L HD Cooling Pkg — Conventional Trailer	3.42	4 218 kg (9,300 lbs)	6 804 kg (15,000 lbs)

<b>Vehicle</b>	<b>Axle Ratio</b>	<b>Maximum Trailer Weight</b>	<b>GCWR (a)</b>
5.3L V8 K5L HD Cooling Pkg — Fifth-Wheel Trailer	3.42	3 674 kg (8,100 lbs)	6 804 kg (15,000 lbs)
<b>2500 Series 2WD Extended Cab Standard Box HD</b>			
6.0L V8	3.73	4 445 kg (9,800 lbs)	7 257 kg (16,000 lbs)
6.0L V8 — Conventional Trailer	4.10	5 897 kg (13,000 lbs)	9 299 kg (20,500 lbs)
6.0L V8 — Fifth-Wheel Trailer	4.10	6 486 kg (14,300 lbs)	9 299 kg (20,500 lbs)
<b>2500 Series 2WD Crew Cab Standard Box HD</b>			
6.0L V8	3.73	4 400 kg (9,700 lbs)	7 257 kg (16,000 lbs)
6.0L V8 — Conventional Trailer	4.10	5 897 kg (13,000 lbs)	9 299 kg (20,500 lbs)
6.0L V8 — Fifth-Wheel Trailer	4.10	6 441 kg (14,200 lbs)	9 299 kg (20,500 lbs)
<b>2500 Series 2WD Regular Cab Long Box HD</b>			
6.0L V8	3.73	4 627 kg (10,200 lbs)	7 257 kg (16,000 lbs)
6.0L V8 — Payload Performance Pkg (UB7)	3.73	4 536 kg (10,000 lbs)	7 257 kg (16,000 lbs)
6.0L V8 — Conventional Trailer	4.10	5 897 kg (13,000 lbs)	9 299 kg (20,500 lbs)
6.0L V8 — Fifth-Wheel Trailer	4.10	6 668 kg (14,700 lbs)	9 299 kg (20,500 lbs)
<b>2500 Series 2WD Extended Cab Long Box HD</b>			
6.0L V8	3.73	4 400 kg (9,700 lbs)	7 257 kg (16,000 lbs)

## 9-82 Driving and Operating

Vehicle	Axle Ratio	Maximum Trailer Weight	GCWR (a)
6.0L V8 — Conventional Trailer	4.10	5 897 kg (13,000 lbs)	9 299 kg (20,500 lbs)
6.0L V8 — Fifth-Wheel Trailer	4.10	6 441 kg (14,200 lbs)	9 299 kg (20,500 lbs)
2500 Series 2WD Crew Cab Long Box HD			
6.0L V8	3.73	4 354 kg (9,600 lbs)	7 257 kg (16,000 lbs)
6.0L V8 — Conventional Trailer	4.10	5 897 kg (13,000 lbs)	9 299 kg (20,500 lbs)
6.0L V8 — Fifth-Wheel Trailer	4.10	6 396 kg (14,100 lbs)	9 299 kg (20,500 lbs)
2500 Series 4WD Extended Cab Standard Box HD			
6.0L V8	3.73	4 309 kg (9,500 lbs)	7 257 kg (16,000 lbs)
6.0L V8 — Conventional Trailer	4.10	5 897 kg (13,000 lbs)	9 299 kg (20,500 lbs)
6.0L V8 — Fifth-Wheel Trailer	4.10	6 350 kg (14,000 lbs)	9 299 kg (20,500 lbs)
2500 Series 4WD Crew Cab Standard Box HD			
6.0L V8	3.73	4 264 kg (9,400 lbs)	7 257 kg (16,000 lbs)
6.0L V8 — Conventional Trailer	4.10	5 897 kg (13,000 lbs)	9 299 kg (20,500 lbs)
6.0L V8 — Fifth-Wheel Trailer	4.10	6 305 kg (13,900 lbs)	9 299 kg (20,500 lbs)
2500 Series 4WD Regular Cab Long Box HD			
6.0L V8	3.73	4 491 kg (9,900 lbs)	7 257 kg (16,000 lbs)
6.0L V8 — Conventional Trailer	4.10	5 897 kg (13,000 lbs)	9 299 kg (20,500 lbs)

<b>Vehicle</b>	<b>Axle Ratio</b>	<b>Maximum Trailer Weight</b>	<b>GCWR (a)</b>
6.0L V8 — Fifth-Wheel Trailer	4.10	6 532 kg (14,400 lbs)	9 299 kg (20,500 lbs)
<b>2500 Series 4WD Extended Cab Long Box HD</b>			
6.0L V8	3.73	4 264 kg (9,400 lbs)	7 257 kg (16,000 lbs)
6.0L V8 — Conventional Trailer	4.10	5 897 kg (13,000 lbs)	9 299 kg (20,500 lbs)
6.0L V8 — Fifth-Wheel Trailer	4.10	6 305 kg (13,900 lbs)	9 299 kg (20,500 lbs)
<b>2500 Series 4WD Crew Cab Long Box HD</b>			
6.0L V8	3.73	4 218 kg (9,300 lbs)	7 257 kg (16,000 lbs)
6.0L V8 — Conventional Trailer	4.10	5 897 kg (13,000 lbs)	9 299 kg (20,500 lbs)
6.0L V8 — Fifth-Wheel Trailer	4.10	6 260 kg (13,800 lbs)	9 299 kg (20,500 lbs)
<b>3500 Series 2WD Regular Cab Long Box</b>			
6.0L V8 (Single Rear Wheels) Conventional Trailer	4.10	5 897 kg (13,000 lbs)	9 299 kg (20,500 lbs)
6.0L V8 (Single Rear Wheels) Fifth-Wheel Trailer	4.10	6 577 kg (14,500 lbs)	9 299 kg (20,500 lbs)
6.0L V8 (Dual Rear Wheels)	3.73	4 354 kg (9,600 lbs)	7 257 kg (16,000 lbs)
6.0L V8 (Dual Rear Wheels) Conventional Trailer	4.10	6 396 kg (14,100 lbs)	9 299 kg (20,500 lbs)

**9-84 Driving and Operating**

<b>Vehicle</b>	<b>Axle Ratio</b>	<b>Maximum Trailer Weight</b>	<b>GCWR (a)</b>
6.0L V8 (Dual Rear Wheels) Fifth-Wheel Trailer	4.10	6 441 kg (14,200 lbs)	9 299 kg (20,500 lbs)
<b>3500 Series 2WD Extended Cab Long Box</b>			
6.0L V8 (Single Rear Wheels)	3.73	4 309 kg (9,500 lbs)	7 257 kg (16,000 lbs)
6.0L V8 (Single Rear Wheels) Conventional Trailer	4.10	5 897 kg (13,000 lbs)	9 299 kg (20,500 lbs)
6.0L V8 (Single Rear Wheels) Fifth-Wheel Trailer	4.10	6 350 kg (14,000 lbs)	9 299 kg (20,500 lbs)
6.0L V8 (Dual Rear Wheels) Conventional Trailer	3.73	4 128kg (9,100 lbs)	7 257 kg (16,000 lbs)
6.0L V8 (Dual Rear Wheels) Fifth-Wheel Trailer	3.73	4 173kg (9,200 lbs)	7 257 kg (16,000 lbs)
6.0L V8 (Dual Rear Wheels) Conventional Trailer	4.10	6 169 kg (13,600 lbs)	9 299 kg (20,500 lbs)
6.0L V8 (Dual Rear Wheels) Fifth-Wheel Trailer	4.10	6 214 kg (13,700 lbs)	9 299 kg (20,500 lbs)
<b>3500 Series 2WD Crew Cab Standard Box</b>			
6.0L V8	3.73	4 309kg (9,500 lbs)	7 257 kg (16,000 lbs)
6.0L V8 — Conventional Trailer	4.10	5 897 kg (13,000 lbs)	9 299 kg (20,500 lbs)

<b>Vehicle</b>	<b>Axle Ratio</b>	<b>Maximum Trailer Weight</b>	<b>GCWR (a)</b>
6.0L V8 Fifth-Wheel Trailer	4.10	6 350 kg (14,000 lbs)	9 299 kg (20,500 lbs)
<b>3500 Series 2WD Crew Cab Long Box</b>			
6.0L V8 (Single Rear Wheels)	3.73	4 264 kg (9,400 lbs)	7 257 kg (16,000 lbs)
6.0L V8 (Single Rear Wheels) Conventional Trailer	4.10	5 897 kg (13,000 lbs)	9 299 kg (20,500 lbs)
6.0L V8 (Single Rear Wheels) Fifth-Wheel Trailer	4.10	6 305 kg (13,900 lbs)	9 299 kg (20,500 lbs)
6.0L V8 (Dual Rear Wheels)	3.73	4 082 kg (9,000 lbs)	7 257 kg (16,000 lbs)
6.0L V8 (Dual Rear Wheels)	4.10	6 123 kg (13,500 lbs)	9 299 kg (20,500 lbs)
<b>3500 Series 4WD Regular Cab Long Box</b>			
6.0L V8 (Single Rear Wheels)	3.73	4 400 kg (9,700 lbs)	7 257 kg (16,000 lbs)
6.0L V8 (Single Rear Wheels) Conventional Trailer	4.10	5 897 kg (13,000 lbs)	9 299 kg (20,500 lbs)
6.0L V8 (Single Rear Wheels) Fifth-Wheel Trailer	4.10	6 441 kg (14,200 lbs)	9 299 kg (20,500 lbs)
6.0L V8 (Dual Rear Wheels)	3.73	4 218 kg (9,300 lbs)	7 257 kg (16,000 lbs)
6.0L V8 (Dual Rear Wheels)	4.10	6 260 kg (13,800 lbs)	9 299 kg (20,500 lbs)

**9-86 Driving and Operating**

<b>Vehicle</b>	<b>Axle Ratio</b>	<b>Maximum Trailer Weight</b>	<b>GCWR (a)</b>
<b>3500 Series 4WD Extended Cab Long Box</b>			
6.0L V8 (Single Rear Wheels)	3.73	4 173 kg (9,200 lbs)	7 257 kg (16,000 lbs)
6.0L V8 (Single Rear Wheels) Conventional Trailer	4.10	5 897 kg (13,000 lbs)	9 299 kg (20,500 lbs)
6.0L V8 (Single Rear Wheels) Fifth-Wheel Trailer	4.10	6 214 kg (13,700 lbs)	9 299 kg (20,500 lbs)
6.0L V8 (Dual Rear Wheels)	3.73	4 037 kg (8,900 lbs)	7 257 kg (16,000 lbs)
6.0L V8 (Dual Rear Wheels)	4.10	6 078 kg (13,400 lbs)	9 299 kg (20,500 lbs)
<b>3500 Series 4WD Crew Cab Standard Box</b>			
6.0L V8	3.73	4 173 kg (9,200 lbs)	7 257 kg (16,000 lbs)
6.0L V8 — Conventional Trailer	4.10	5 897 kg (13,000 lbs)	9 299 kg (20,500 lbs)
6.0L V8 — Fifth-Wheel Trailer	4.10	6 214 kg (13,700 lbs)	9 299 kg (20,500 lbs)
<b>3500 Series 4WD Crew Cab Long Box</b>			
6.0L V8 (Single Rear Wheels)	3.73	4 128 kg (9,100 lbs)	7 257 kg (16,000 lbs)
6.0L V8 (Single Rear Wheels) Conventional Trailer	4.10	5 897 kg (13,000 lbs)	9 299 kg (20,500 lbs)
6.0L V8 (Single Rear Wheels) Fifth-Wheel Trailer	4.10	6 169 kg (13,600 lbs)	9 299 kg (20,500 lbs)



Vehicle	Axle Ratio	Maximum Trailer Weight	GCWR (a)
6.0L V8 (Dual Rear Wheels)	3.73	3 946 kg (8,700 lbs)	7 257 kg (16,000 lbs)
6.0L V8 (Dual Rear Wheels)	4.10	5 987 kg (13,200 lbs)	9 299 kg (20,500 lbs)

(a) The Gross Combination Weight Rating (GCWR) is the total allowable weight of the completely loaded vehicle and trailer including any passengers, cargo, equipment, and conversions. The GCWR for the vehicle should not be exceeded.

(b) This model is neither designed nor intended to tow fifth-wheel or gooseneck trailers.

Ask your dealer for trailering information or advice.

### Weight of the Trailer Tongue

The tongue load (A) of any trailer is very important because it is also part of the vehicle weight. The Gross Vehicle Weight (GVW) includes the curb weight of the vehicle, any cargo carried in it, and the people who will be riding in the vehicle as well as trailer tongue weight. Vehicle options, equipment, passengers and cargo in the vehicle reduce the amount of tongue weight the vehicle can carry, which will also reduce the trailer weight the vehicle

can tow. See "Vehicle Load Limits" for more information about the vehicle's maximum load capacity.

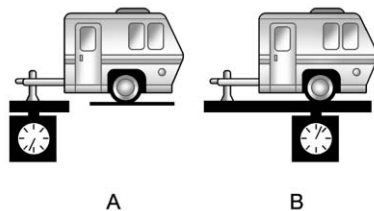

Trailer tongue weight (A) should be 10 to 15 percent and fifth-wheel or gooseneck kingpin weight should be 15 to 25 percent of the loaded trailer weight up to the maximums for vehicle series and hitch type.

## 9-88 Driving and Operating

Vehicle Series	Hitch Type	Maximum Tongue Weight
1500	Weight Carrying	363 kg (800 lb)
1500	Weight Distributing	499 kg (1,100 lb)
2500/3500 Standard Box	Weight Carrying or Weight Distributing	680 kg (1,500 lb)
2500/3500 Long Box	Weight Carrying or Weight Distributing	907 kg (2,000 lb)
2500	Fifth-Wheel Gooseneck	1 361 kg (3,000 lb)
3500 Single Rear Wheels	Fifth-Wheel Gooseneck	1 814 kg (4,000 lb)
3500 Dual Rear Wheels	Fifth-Wheel Gooseneck	2 495 kg (5,500 lb)

Do not exceed the maximum allowable tongue weight for the vehicle. Choose the shortest hitch extension that will position the hitch ball closest to the vehicle. This will help reduce the effect of trailer tongue weight on the rear axle.

Trailer rating may be limited by the vehicle's ability to carry tongue weight. Tongue or kingpin weight cannot cause the vehicle to exceed the GVWR (Gross Vehicle Weight Rating) or the RGAWR (Rear Gross Axle Weight Rating). See "Total Weight on the Vehicle's Tires" later in this section for more information.

After loading the trailer, weigh the trailer and then the tongue, separately, to see if the weights are proper. If they are not, adjustments might be made by moving some items around in the trailer.

### Total Weight on the Vehicle's Tires

Be sure the vehicle's tires are inflated to the inflation pressures found on the Certification Tire label on the drivers door or see *Vehicle Load Limits* on page 9-15 for more information. Make sure not to exceed the GVWR limit for the vehicle, or the RGAWR, with the tow vehicle and trailer fully loaded for the trip including the weight of the trailer tongue. If using a weight-distributing hitch, make sure not to exceed the RGAWR before applying the weight distribution spring bars.

## Weight of the Trailing Combination

It is important that the combination of the tow vehicle and trailer does not exceed any of its weight ratings — GCWR, GVWR, RGAWR, Trailer Weight Rating, or Tongue Weight. The only way to be sure it is not exceeding any of these ratings is to weigh the tow vehicle and trailer combination, fully loaded for the trip, getting individual weights for each of these items.

## Towing Equipment

### Hitches

The correct hitch equipment helps maintain combination control. Many trailers can be towed with a weight-carrying hitch which simply features a coupler latched to the hitch ball, or a tow eye latched to a pintle hook. Other trailers may require a weight-distributing hitch that uses spring bars to distribute the trailer tongue weight among the two vehicle and trailer axles. Fifth-wheel and gooseneck hitches may also be used. See “Weight of the Trailer Tongue” under *Trailer Towing on page 9-73* for rating limits with various hitch types.

If a step-bumper hitch will be used, the bumper could be damaged in sharp turns. Make sure there is ample room when turning to avoid contact between the trailer and the bumper.

Consider using sway controls with any trailer. Ask a trailering professional about sway controls or refer to the trailer manufacturer's recommendations and instructions.

### Weight-Distributing Hitch and Adjustment

A weight distributing hitch may be useful with some trailers. Use the following guidelines to determine if a weight distributing hitch should be used.

## 9-90 Driving and Operating

Vehicle Series	Trailer Weight	Weight Distributing Hitch Usage	Hitch Distribution
1500	Up to 7000 lbs	Optional	Refer to trailer manufacturer's recommendation
1500	7001 to 9900 lbs	Required	50%
1500	Over 9900 lbs	Required	100%
2500/3500	Up to 18000 lbs	Optional	Refer to trailer manufacturer's recommendation

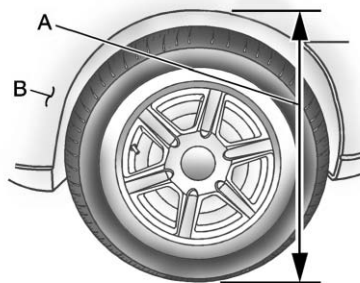

A. Body to Ground Distance

### B. Front of Vehicle

When using a weight-distributing hitch, measure distance (A) before coupling the trailer to the hitch ball. If the hitch requires 50% distribution, measure the height again after the trailer is coupled and adjust the spring bars so the distance (A) is as close as possible to halfway between the two measurements. When 100% distribution is required the spring bars should be adjusted so the distance (A) is the same as the

initial measurement after coupling the trailer to the tow vehicle and adjusting the hitch.

### Fifth-Wheel and Gooseneck Trailing

Fifth-wheel and gooseneck trailers can be used with many pickup models. These trailers place a larger percentage of the weight (kingpin weight) on the tow vehicle than conventional trailers. Make sure this weight does not cause the vehicle to exceed GAWR or GVWR.

Fifth-wheel or gooseneck kingpin weight should be 15 to 25 percent of the trailer weight up to the maximum amount specified in the trailering chart for the vehicle. See "Weight of the Trailer" under *Trailer Towing on page 9-73* for more information.

The hitch should be located in the pickup bed so that its centerline is over or slightly in front of the rear axle. Take care that it is not so far forward that it will contact the back of the cab in sharp turns. This is especially important for short box pickups. Trailer pin box extensions and sliding fifth-wheel hitch assemblies can help this condition. There should be at least six inches of clearance between the top of the pickup box and the bottom of the trailer shelf that extends over the box.

Make sure the hitch is attached to the tow vehicle frame rails. Do not use the pickup box for support.

### Safety Chains

Always attach chains between the vehicle and the trailer. Cross the safety chains under the tongue of the trailer to help prevent the tongue from contacting the road if it becomes separated from the hitch. Instructions about safety chains may be provided by the hitch manufacturer or by the trailer manufacturer. If the trailer being towed weighs up to 2 271 kg (5,000 lbs) with a factory-installed step bumper, safety chains may be attached to the attaching points on the bumper; otherwise, safety chains should be attached to holes on the trailer hitch platform. Always leave just enough slack so the combination can turn. Never allow safety chains to drag on the ground.

### Trailer Brakes

A loaded trailer that weighs more than 900 kg (2,000 lbs) needs to have its own brake system that is adequate for the weight of the trailer. Be sure to read and follow

the instructions for the trailer brakes so they are installed, adjusted, and maintained properly.

Do not tap into the vehicle's hydraulic brake system.

### Auxiliary Battery

The auxiliary battery provision can be used to supply electrical power to additional equipment that may be added, such as a slide-in camper. If the vehicle has this provision, this relay will be located on the driver side of the vehicle, next to the underhood electrical center.

Be sure to follow the proper installation instructions included with any electrical equipment that is installed.

**Notice: Leaving electrical equipment on for extended periods will drain the battery. Always turn off electrical equipment when not in use and do not use equipment that**

## 9-92 Driving and Operating

exceeds the maximum amperage rating of 40 amperes for the auxiliary battery provision.

### Trailer Wiring Harness

The vehicle is equipped with one of the following wiring harnesses for towing a trailer or hauling a slide-in camper.

#### Basic Trailer Wiring

All regular, extended cab and crew cab pickups have a seven-wire trailer towing harness.

For vehicles not equipped with heavy duty trailering, the harness is secured to the vehicle's frame behind the spare tire mount. The harness requires the installation of a trailer connector, which is available through your dealer.

If towing a light-duty trailer with a standard four-way round pin connector, an adapter is available from your dealer.

### Heavy-Duty Trailer Wiring Harness Package

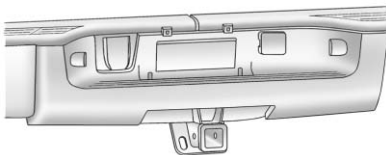

For vehicles equipped with heavy duty trailering, the harness connector is mounted in the bumper. The seven-wire harness contains the following trailer circuits:

- Yellow: Left Stop/Turn Signal
- Dark Green: Right Stop/Turn Signal
- Brown: Taillamps
- White: Ground
- Light Green: Back-up Lamps

- Red: Battery Feed\*
- Dark Blue: Trailer Brake\*

\*The fuses for these two circuits are installed in the underhood electrical center, but the wires are not connected. They should be connected by your dealer or a qualified service center. The fuse and wire for the ITBC is factory installed and connected if the vehicle is equipped with an ITBC. The fuse for the battery feed is not required if the vehicle has an auxiliary battery. If the vehicle does not have an auxiliary battery, have your dealer or authorized service center install the required fuse.

If charging a remote (non-vehicle) battery, press the Tow/Haul Mode button, if equipped, located at the end of the shift lever. This will boost the vehicle system voltage and properly charge the battery. If the trailer is too light for Tow/Haul Mode, or the vehicle is not equipped with Tow/Haul, turn on the

headlamps as a second way to boost the vehicle system and charge the battery.

### Camper/Fifth-Wheel Trailer Wiring Package

The seven-wire camper harness is located under the front edge of the pickup box on the driver side of the vehicle, attached to the frame bracket. A connector must be added to the wiring harness which connects to the camper.

The harness contains the following camper/trailer circuits:

- Yellow: Left Stop/Turn Signal
- Dark Green: Right Stop/Turn Signal
- Brown: Taillamps
- White: Ground
- Light Green: Back-up Lamps
- Red: Battery Feed
- Dark Blue: Trailer Brake

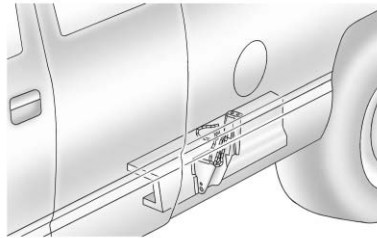

If the vehicle is equipped with the “Heavy-Duty Trailering” option, please refer to “Heavy-Duty Trailer Wiring Package” earlier in this section.

When the camper-wiring harness is ordered without the heavy-duty trailering package, a seven-wire harness with a seven-pin connector is located at the rear of the vehicle and is tied to the vehicle's frame.

### Electric Brake Control Wiring Provisions

These wiring provisions are included with the vehicle as part of the trailer wiring package. These provisions are for an electric brake controller. The instrument panel contains blunt cut wires behind the steering column for the trailer brake controller. The harness contains the following wires:

- Dark Blue: Brake Signal to Trailer Connector
- Red/Black: Battery
- Light Blue/White: Brake Switch
- White: Ground

The harness should be installed by your dealer or a qualified service center.

If the vehicle is equipped with an Integrated Trailer Brake Control (ITBC) System, the blunt cuts exist, but are not connected further in the harness. If an aftermarket trailer brake controller is installed, the

## 9-94 Driving and Operating

ITBC must be disconnected. Do not power both ITBC and aftermarket controllers to control the trailer brakes at the same time.

### Tow/Haul Mode

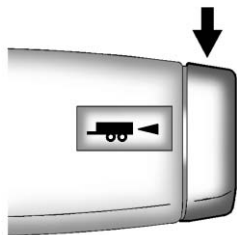

Pressing this button at the end of the shift lever turns on and off the Tow/Haul Mode.



This indicator light on the instrument panel cluster comes on when the Tow/Haul Mode is on.

Tow/Haul is a feature that assists when pulling a heavy trailer or a large or heavy load. See *Tow/Haul Mode on page 9-37* for more information.

Tow/Haul is designed to be most effective when the vehicle and trailer combined weight is at least 75 percent of the vehicle's Gross Combined Weight Rating (GCWR). See "Weight of the Trailer" under *Trailer Towing on page 9-73*. Tow/Haul is most useful under the following driving conditions:

- When pulling a heavy trailer or a large or heavy load through rolling terrain.

- When pulling a heavy trailer or a large or heavy load in stop-and-go traffic.
- When pulling a heavy trailer or a large or heavy load in busy parking lots where improved low speed control of the vehicle is desired.

Operating the vehicle in Tow/Haul when lightly loaded or with no trailer at all will not cause damage. However, there is no benefit to the selection of Tow/Haul when the vehicle is unloaded. Such a selection when unloaded may result in unpleasant engine and transmission driving characteristics and reduced fuel economy. Tow/Haul is recommended only when pulling a heavy trailer or a large or heavy load.



## Integrated Trailer Brake Control System



The vehicle may have an Integrated Trailer Brake Control (ITBC) system for electric trailer brakes.

This symbol is located on the Trailer Brake Control Panel on vehicles with an Integrated Trailer Brake Control system. The power output to the trailer brakes is based on the amount of brake pressure being applied by the vehicle's brake system. This available power output to the trailer brakes can be adjusted to a wide range of trailering situations.

The ITBC system is integrated with the vehicle's brake, antilock brake, and StabiliTrak (if equipped) systems. In trailering conditions that

cause the vehicle's antilock brake or StabiliTrak systems to activate, power sent to the trailer's brakes will be automatically adjusted to minimize trailer wheel lock-up. This does not imply that the trailer has StabiliTrak.

The vehicle may have a Trailer Sway Control (TSC) feature. See *Trailer Sway Control (TSC)* on page 9-100.

The vehicle may have a Hill Start Assist (HSA) feature. See *Hill Start Assist (HSA)* on page 9-52.

If the vehicle's brake, antilock brake, or StabiliTrak systems are not functioning properly, the ITBC system may not be fully functional or may not function at all. Make sure all of these systems are fully operational to ensure full functionality of the ITBC system.

The ITBC system is powered through the vehicle's electrical system. Turning the ignition off will also turn off the ITBC system. The

ITBC system is fully functional only when the ignition is in ON or in RUN.

The ITBC system can only be used with trailers with electric brakes.

### WARNING

Connecting a trailer that has a surge, air, or electric-over-hydraulic trailer brake system may result in reduced or complete loss of trailer braking. There may be an increase in stopping distance or trailer instability which could result in personal injury or damage to the vehicle, trailer, or other property. Use the ITBC system only with electric brakes.

### Trailer Brake Control Panel

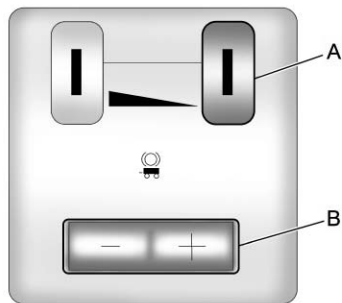

A. Manual Trailer Brake Apply Lever

B. Trailer Gain Adjustment Buttons

The ITBC system has a control panel located on the left of the instrument panel to the left of the steering column. See *Instrument Panel (Base/Uplevel Version)* on page 1-2 or *Instrument Panel (Premium Version)* on page 1-5 for more information. The control panel allows adjustment to the amount of output, referred to as trailer gain,

available to the electric trailer brakes and allows manual application of the trailer brakes. The Trailer Brake Control Panel is used along with the Trailer Brake Display Page on the DIC to adjust and display power output to the trailer brakes.

### Trailer Brake DIC Display Page

The ITBC system displays messages on the vehicle's Driver Information Center (DIC). See *Driver Information Center (DIC)* on page 5-28 for more information.

The display page indicates Trailer Gain setting, power output to the electric trailer brakes, trailer connection, and system operational status.

The Trailer Brake Display Page can be displayed by performing any of the following actions:

- Scrolling through the DIC menu pages using the odometer trip stem or the DIC Vehicle Information button (if equipped).

- Pressing a Trailer Gain button— If the Trailer Brake Display Page is not currently displayed, pressing a Trailer Gain button will first recall the current Trailer Gain setting. After the Trailer Brake Display Page is displayed, each press and release of the gain buttons will then cause the Trailer Gain setting to change.
- Activating the Manual Trailer Brake Apply lever.
- Connecting a trailer equipped with electric trailer brakes.

All DIC warning and service messages must first be acknowledged by the driver by pressing the odometer trip stem or the DIC Vehicle Information button (if equipped) before the Trailer Brake Display Page can be displayed and Trailer Gain can be adjusted.

**TRAILER GAIN:** This setting is displayed any time the Trailer Brake Display Page is active. This setting can be adjusted from 0.0 to

10.0 with either a trailer connected or disconnected. To adjust the Trailer Gain, press one of the Trailer Gain adjustment buttons located on the Trailer Brake Control Panel. Press and hold a gain button to cause the Trailer Gain to continuously adjust. To turn the output to the trailer off, adjust the Trailer Gain setting to 0.0 (zero).

0.0 (zero) gain is the factory default setting. To properly adjust trailer gain, see “Trailer Gain Adjustment Procedure” later in this section.

**TRAILER OUTPUT:** This is displayed any time a trailer with electric brakes is connected. Output to the electric brakes is based on the amount of vehicle braking present and relative to the Trailer Gain setting. Output is displayed from 0 to 10 bars for each gain setting.

Non-hybrid vehicles with Trailer Sway Control (TSC) or Hill Start Assist (HSA), output to the electric trailer brakes may be displayed

when the systems are active. See *Trailer Sway Control (TSC) on page 9-100* and *Hill Start Assist (HSA) on page 9-52*.

The Trailer Output will indicate “- - - - -” on the Trailer Brake Display Page whenever the following occur:

- No trailer is connected
- A trailer without electric brakes is connected (no DIC message is displayed)
- A trailer with electric brakes has become disconnected (a CHECK TRAILER WIRING message will also be displayed on the DIC)
- There is a fault present in the wiring to the electric trailer brakes (a CHECK TRAILER WIRING message will also be displayed on the DIC)
- There is a fault in the ITBC system (a SERVICE TRAILER BRAKE SYSTEM message will also be displayed in the DIC)

### Manual Trailer Brake Apply

The Manual Trailer Brake Apply Lever is located on the Trailer Brake Control Panel and is used to apply the trailer's electric brakes independent of the vehicle's brakes. This lever is used in the Trailer Gain Adjustment Procedure to properly adjust the power output to the trailer brakes. Sliding the lever to the left will apply only the trailer brakes. The power output to the trailer is indicated in the Trailer Brake Display Page on the DIC. If the vehicle's service brakes are applied while using the Manual Trailer Brake Apply Lever, the trailer output power will be the greater of the two.

The trailer's and the vehicle's brake lamps will come on when either vehicle braking or manual trailer brakes are applied.

## 9-98 Driving and Operating

---

### Trailer Gain Adjustment Procedure

Trailer Gain should be set for a specific trailering condition and must be adjusted any time vehicle loading, trailer loading, or road surface conditions change.

Setting the Trailer Gain properly is needed for the best trailer stopping performance. A trailer that is over-gained may result in locked trailer brakes. A trailer that is under-gained may result in not enough trailer braking. Both of these conditions may result in poorer stopping and stability of the vehicle and trailer.

Use the following procedure to correctly adjust Trailer Gain for each towing condition:

1. Make sure the trailer brakes are in proper working condition.
2. Connect a properly loaded trailer to the vehicle and make all necessary mechanical and

electrical connections. See *Vehicle Load Limits on page 9-15* for more information.

3. After the electrical connection is made to a trailer equipped with electric brakes:
  - A TRAILER CONNECTED message will be briefly displayed on the DIC.
  - The Trailer Brake Display Page will appear on the DIC showing TRAILER GAIN and TRAILER OUTPUT.
  - In the Trailer Output display on the DIC, “- - - - -” will disappear if there is no error present. Connecting a trailer without electric brakes will not clear the six dashed lines.
4. Adjust the Trailer Gain by using the gain adjustment (+ / -) buttons on the Trailer Brake Control Panel.

5. Drive the vehicle with the trailer attached on a level road surface representative of the towing condition and free of traffic at about 32 to 40 km/h (20 to 25 mph) and fully apply the Manual Trailer Brake Apply Lever.

Adjusting trailer gain at speeds lower than 32 to 40 km/h (20 to 25 mph) may result in an incorrect gain setting.

6. Adjust the Trailer Gain to just below the point of trailer wheel lock-up, indicated by trailer wheel squeal or tire smoke when a trailer wheel locks.

Trailer wheel lock-up may not occur if towing a heavily loaded trailer. In this case, adjust the Trailer Gain to the highest allowable setting for the towing condition.

7. Re-adjust Trailer Gain any time vehicle loading, trailer loading or road surface conditions change or if trailer wheel lock-up is noticed at any time while towing.

### Other ITBC-Related DIC Messages

In addition to displaying TRAILER GAIN and TRAILER OUTPUT through the DIC, trailer connection and ITBC system status are displayed on the DIC.

**TRAILER CONNECTED:** This message will be briefly displayed when a trailer with electric brakes is first connected to the vehicle. This message will automatically turn off in about 10 seconds. The driver can also acknowledge this message before it automatically turns off.

**CHECK TRAILER WIRING:** This message will be displayed if:

1. The ITBC system first determines connection to a trailer with electric brakes and then the trailer harness becomes disconnected from the vehicle.

If the disconnect occurs while the vehicle is stationary, this message will automatically turn off in about 30 seconds. This message will also turn off if the driver acknowledges this message or if the trailer harness is re-connected.

If the disconnect occurs while the vehicle is moving, this message will continue until the ignition is turned off. This message will also turn off if the driver acknowledges this message or if the trailer harness is re-connected.

2. There is an electrical fault in the wiring to the electric trailer brakes. This message will continue as long as there is an electrical fault in the trailer wiring. This message will also turn off if the driver acknowledges this message.

To determine if the electrical fault is on the vehicle side or trailer side of the trailer wiring harness connection, do the following:

1. Disconnect the trailer wiring harness from the vehicle.
2. Turn the ignition off.
3. Wait 10 seconds, then turn the ignition back to RUN.
4. If the CHECK TRAILER WIRING message re-appears, the electrical fault is on the vehicle side.

If the CHECK TRAILER WIRING message only re-appears when connecting the trailer wiring harness to the vehicle, the electrical fault is on the trailer side.

**SERVICE TRAILER BRAKE SYSTEM:** This message will be displayed when there is a problem with the ITBC system. If this message persists over multiple ignition cycles, there is a problem with the ITBC system. Take the vehicle to an authorized GM dealer to have the ITBC system diagnosed and repaired.

If either the CHECK TRAILER WIRING or SERVICE TRAILER BRAKE SYSTEM message is displayed while driving the vehicle,

power is no longer available to the trailer brakes. When traffic conditions allow, carefully pull the vehicle over to the side of the road and turn the ignition off. Check the wiring connection to the trailer and turn the ignition back on. If either of these messages continues, either the vehicle or trailer needs service.

An authorized GM dealer may be able to diagnose and repair problems with the trailer. However, any diagnosis and repair of the trailer is not covered under the vehicle warranty. Please contact your trailer dealer for assistance with trailer repairs and trailer warranty information.

### Trailer Sway Control (TSC)

Non-hybrid vehicles with StabiliTrak have a Trailer Sway Control (TSC) feature. If the vehicle is towing a trailer and the system detects that the trailer is swaying, the vehicle brakes are applied without the driver pressing the brake pedal. If the vehicle is equipped with the Integrated Trailer Brake Control (ITBC) system, StabiliTrak may also apply the trailer brakes. The TCS/StabiliTrak warning light will flash on the instrument panel cluster to notify the driver to reduce speed. If the trailer continues to sway, StabiliTrak will reduce engine torque to help slow the vehicle. See *StabiliTrak® System* on page 9-53 for more information.

Adding non-dealer accessories can affect the vehicle performance. See *Accessories and Modifications* on page 10-3 for more information.

## Conversions and Add-Ons

### Add-On Electrical Equipment

**Notice:** Some electrical equipment can damage the vehicle or cause components to not work and would not be covered by the warranty. Always check with your dealer before adding electrical equipment.

Add-on equipment can drain the vehicle's 12-volt battery, even if the vehicle is not operating.

The vehicle has an airbag system. Before attempting to add anything electrical to the vehicle, see *Servicing the Airbag-Equipped Vehicle on page 3-35* and *Adding Equipment to the Airbag-Equipped Vehicle on page 3-35*.

### Adding a Snow Plow or Similar Equipment

Before installing a snow plow on the vehicle, here are some things you need to know:

**Notice:** If the vehicle does not have the snow plow prep package, adding a plow can damage the vehicle, and the repairs would not be covered by warranty. Unless the vehicle was built to carry a snow plow, do not add one to the vehicle. If the vehicle has the snow plow prep package, called RPO VYU, then the payload the vehicle can carry will be reduced when a snow plow is installed. The vehicle can be damaged if either the front or rear axle ratings or the Gross Vehicle Weight Rating (GVWR) are exceeded.

Some vehicles are built with a special snow plow prep package, called RPO VYU. If the vehicle has this option, you can add a plow to it, provided certain weights, such as

the weights on the vehicle's axles and the Gross Vehicle Weight Rating (GVWR), are not exceeded.

The plow the vehicle can carry depends on many things, such as:

- The options the vehicle came with, and the weight of those options.
- The weight and number of passengers intended to be carried.
- The weight of items added to the vehicle, like a tool box or truck cap.
- The total weight of any additional cargo intended to be carried.

Say, for example, you have a 318 kg (700 lb) snow plow. The total weight of all occupants and cargo inside the cab should not exceed 135 kg (300 lb). This means that you may only be able to carry one passenger. But, even this may be too much if there is other equipment already adding to the weight of the vehicle.

## 9-102 Driving and Operating

Here are some guidelines for safely carrying a snow plow on the vehicle:

- Make sure the weight on the front and rear axles does not exceed the axle rating for each.
- For the front axle, if more cargo or passengers must be carried, appropriate counter ballast must be installed rear of the rear axle. Counter ballast must be properly secured so it will not move during driving.
- Follow the snow plow manufacturer's recommendations regarding rear ballast. Rear ballast may be required to ensure a proper front and rear weight distribution ratio, even though the actual weight at the front axle may be less than the front axle rating.

- The snow plow manufacturer or installer can assist you in determining the amount of rear ballast required, to help make sure the snowplow/vehicle combination does not exceed the GVW rating, the front and rear axle ratings, and the front and rear weight distribution ratio.
- The total vehicle must not exceed the GVW rating.

Front axle reserve capacity is the difference between the Gross Axle Weight Rating (GAWR) and the front axle weight of the vehicle with full fuel and passengers. Basically, it is the amount of weight that can be added to the front axle before reaching the front GAWR.

The front axle reserve capacity for the vehicle can be found in the lower right corner of the Certification/Tire label, as shown.

: TRUCK

COLD TIRE PRESSURE  
XXXKPA(XXPSI)  
XXXKPA(XXPSI)  
E INFORMATION → F XXX LB  
T XXXX LB

**United States**



COLD TIRE PRESSURE  
PRESSION A FROID  
XXXXXXXX(XXPSI)  
XXXXXXXX(XXPSI)  
→ AV / F XXX LB T XXX LB

**Canada**



In order to calculate the amount of weight any front accessory, such as a snow plow, is adding to the front axle, use the following formula:

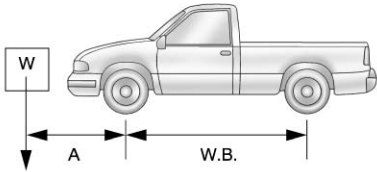

$(W \times (A + W.B.)) / W.B. =$  Weight the accessory is adding to the front axle.

Where:

- W = Weight of added accessory
- A = Distance that the accessory is in front of the front axle
- W.B. = Vehicle Wheelbase

For example, adding a 318 kg (700 lb) snow plow actually adds more than 318 kg (700 lb) to the front axle. Using the formula, if the snow plow is 122 cm (4 ft) in front of the front axle and the wheel base is 305 cm (10 ft), then:

- W = 318 kg (700 lb)
- A = 122 cm (4 ft)
- W.B. = 305 cm (10 ft)

$$(W \times (A + W.B.)) / W.B. =$$

$$(318 \times (122 + 305)) / 305 = 445 \text{ kg}$$

(980 lbs)

So, if the front axle reserve capacity is more than 445 kg (980 lbs), the snow plow could be added without exceeding the front GAWR.

Heavier equipment can be added on the front of the vehicle if it is compensated for by carrying fewer passengers, less cargo, or by positioning cargo toward the rear. This has the effect of reducing the load on the front. However, the front GAWR, rear GAWR, and the Gross Vehicle Weight Rating (GVWR) must never be exceeded.

**⚠ WARNING**

On some vehicles that have certain front mounted equipment, such as a snow plow, it may be possible to load the front axle to the front gross axle weight rating (GAWR) but not have enough weight on the rear axle to have proper braking performance. If the brakes cannot work properly, you could have a crash. To help the brakes work properly when a snow plow is installed, always follow the snow plow manufacturer or installer's recommendation for rear ballast to ensure a proper front and rear weight distribution ratio, even though the actual front weight may be less than the front GAWR, and the total vehicle weight is less than the gross vehicle weight rating (GVWR).

(Continued)

### WARNING (Continued)

Maintaining a proper front and rear weight distribution ratio is necessary to provide proper braking performance.

Total vehicle reserve capacity is the difference between the GVWR and the weight of the truck with full fuel and passengers. It is the amount of weight that can be added to the vehicle before reaching the GVWR. Keep in mind that reserve capacity numbers are intended as a guide when selecting the amount of equipment or cargo the truck can carry. If unsure of the vehicle's front, rear, or total weight, go to a weigh station and weigh the vehicle. Your dealer can also help with this.

The total vehicle reserve capacity for the vehicle can be found in the lower right corner of the Certification/Tire label as shown previously.

See your dealer for additional advice and information about using a snow plow on the vehicle. Also, see *Vehicle Load Limits on page 9-15*.

### Emergency Roof Lamp Provisions

Vehicles with the RPO VYU snow plow prep package also have an emergency roof lamp provision package, RPO TRW. Wiring for the emergency roof lamp is provided above the overhead console. See *Auxiliary Roof-Mounted Lamp on page 6-6* for switch location.

### Pickup Conversion to Chassis Cab

We are aware that some vehicle owners might consider having the pickup box removed and a commercial or recreational body installed. Owners should be aware that, as manufactured, there are differences between a chassis cab and a pickup with the box removed which could affect vehicle safety. The components necessary to adapt a pickup to permit its safe use with a specialized body should be installed by the body builder.

## Vehicle Care

### General Information

General Information .....	10-2
California Proposition 65 Warning .....	10-2
California Perchlorate Materials Requirements ....	10-3
Accessories and Modifications .....	10-3

### Vehicle Checks

Doing Your Own Service Work .....	10-3
Hood .....	10-4
Engine Compartment Overview .....	10-5
Engine Oil .....	10-6
Engine Oil Life System .....	10-9
Automatic Transmission Fluid (4-Speed Transmission) .....	10-10
Automatic Transmission Fluid (6-Speed Transmission) .....	10-12
Engine Air Cleaner/Filter ....	10-15
Cooling System .....	10-16
Engine Coolant .....	10-17

Engine Overheating .....	10-20
Overheated Engine Protection Operating Mode .....	10-22
Engine Fan .....	10-22
Power Steering Fluid .....	10-23
Washer Fluid .....	10-23
Brakes .....	10-24
Brake Fluid .....	10-25
Battery .....	10-27
Four-Wheel Drive .....	10-28
Front Axle .....	10-29
Rear Axle .....	10-30
Noise Control System .....	10-31
Starter Switch Check .....	10-32
Automatic Transmission Shift Lock Control Function Check .....	10-32
Ignition Transmission Lock Check .....	10-32
Park Brake and P (Park) Mechanism Check .....	10-33
Wiper Blade Replacement .....	10-33
Glass Replacement .....	10-34

### Headlamp Aiming

Headlamp Aiming .....	10-34
-----------------------	-------

### Bulb Replacement

Bulb Replacement .....	10-34
Halogen Bulbs .....	10-34
Headlamps, Front Turn Signal, Sidemarker, and Parking Lamps .....	10-35
Pick-Up Box Identification and Fender Marker Lamps .....	10-35
Taillamps (Chassis Cab Models) .....	10-36
Taillamps, Turn Signal, Stoplamps, and Back-Up Lamps .....	10-36
Center High-Mounted Stoplamp (CHMSL) and Cargo Lamp .....	10-37
License Plate Lamp .....	10-37
Replacement Bulbs .....	10-38

### Electrical System

Electrical System Overload .....	10-38
Fuses and Circuit Breakers .....	10-39
Engine Compartment Fuse Block .....	10-39
Instrument Panel Fuse Block .....	10-43

## 10-2 Vehicle Care

---

### Wheels and Tires

Tires .....	10-46
All-Season Tires .....	10-47
Winter Tires .....	10-48
Summer Tires .....	10-48
Tire Sidewall Labeling .....	10-48
Tire Designations .....	10-51
Tire Terminology and Definitions .....	10-52
Tire Pressure .....	10-55
Tire Pressure for High-Speed Operation .....	10-56
Tire Pressure Monitor System .....	10-57
Tire Pressure Monitor Operation .....	10-58
Tire Inspection .....	10-61
Tire Rotation .....	10-61
Dual Tire Rotation .....	10-63
When It Is Time for New Tires .....	10-64
Buying New Tires .....	10-65
Different Size Tires and Wheels .....	10-66

Uniform Tire Quality Grading .....	10-67
Wheel Alignment and Tire Balance .....	10-68
Wheel Replacement .....	10-69
Tire Chains .....	10-70
If a Tire Goes Flat .....	10-70
Tire Changing .....	10-72
Full-Size Spare Tire .....	10-82

### Jump Starting

Jump Starting .....	10-82
---------------------	-------

### Towing

Towing the Vehicle .....	10-87
Recreational Vehicle Towing .....	10-87

### Appearance Care

Exterior Care .....	10-91
Interior Care .....	10-94
Floor Mats .....	10-97

## General Information

For service and parts needs, visit your dealer. You will receive genuine GM parts and GM-trained and supported service people.

Genuine GM parts have one of these marks:

***ACDelco***<sup>®</sup>

---

Genuine  Parts

---

 **Accessories**

## California Proposition 65 Warning

Most motor vehicles, including this one, contain and/or emit chemicals known to the State of California to

cause cancer and birth defects or other reproductive harm. Engine exhaust, many parts and systems, many fluids, and some component wear by-products contain and/or emit these chemicals.

## California Perchlorate Materials Requirements

Certain types of automotive applications, such as airbag initiators, safety belt pretensioners, and lithium batteries contained in Remote Keyless Entry transmitters, may contain perchlorate materials. Special handling may be necessary. For additional information, see [www.dtsc.ca.gov/hazardouswaste/perchlorate](http://www.dtsc.ca.gov/hazardouswaste/perchlorate).

## Accessories and Modifications

Adding non-dealer accessories or making modifications to the vehicle can affect vehicle performance and safety, including such things as airbags, braking, stability, ride and

handling, emissions systems, aerodynamics, durability, and electronic systems like antilock brakes, traction control, and stability control. These accessories or modifications could even cause malfunction or damage not covered by the vehicle warranty.

Damage to vehicle components resulting from modifications or the installation or use of non-GM certified parts, including control module or software modifications, is not covered under the terms of the vehicle warranty and may affect remaining warranty coverage for affected parts.

GM Accessories are designed to complement and function with other systems on the vehicle. See your dealer to accessorize the vehicle using genuine GM Accessories installed by a dealer technician.

Also, see *Adding Equipment to the Airbag-Equipped Vehicle* on page 3-35.

## Vehicle Checks

### Doing Your Own Service Work

If the vehicle is a hybrid, see the hybrid supplement for more information.

#### **WARNING**

It can be dangerous to work on your vehicle if you do not have the proper knowledge, service manual, tools, or parts. Always follow owner manual procedures and consult the service manual for your vehicle before doing any service work.

## 10-4 Vehicle Care

If doing some of your own service work, use the proper service manual. It tells you much more about how to service the vehicle than this manual can. To order the proper service manual, see *Service Publications Ordering Information* on page 13-16.

This vehicle has an airbag system. Before attempting to do your own service work, see *Airbag System Check* on page 3-37.

Keep a record with all parts receipts and list the mileage and the date of any service work performed. See *Maintenance Records* on page 11-16.

**Notice:** Even small amounts of contamination can cause damage to vehicle systems. Do not allow contaminants to contact the fluids, reservoir caps, or dipsticks.

### Hood

To open the hood:



1. Pull the handle with this symbol on it. It is inside the vehicle to the lower left of the steering wheel.

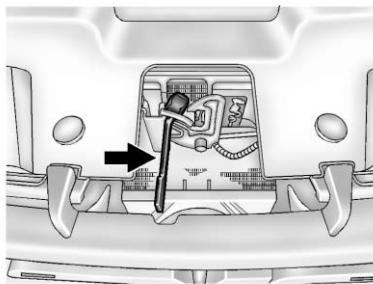

2. Then go to the front of the vehicle and locate the secondary hood release, near the center of the grille.
3. Push the secondary hood release to the right.
4. Lift the hood.

Before closing the hood, be sure all the filler caps are on properly. Then bring the hood from full open to within 152 mm (6 in) from the closed position, pause, then push the front center of the hood with a swift, firm motion to fully close the hood.

## Engine Compartment Overview

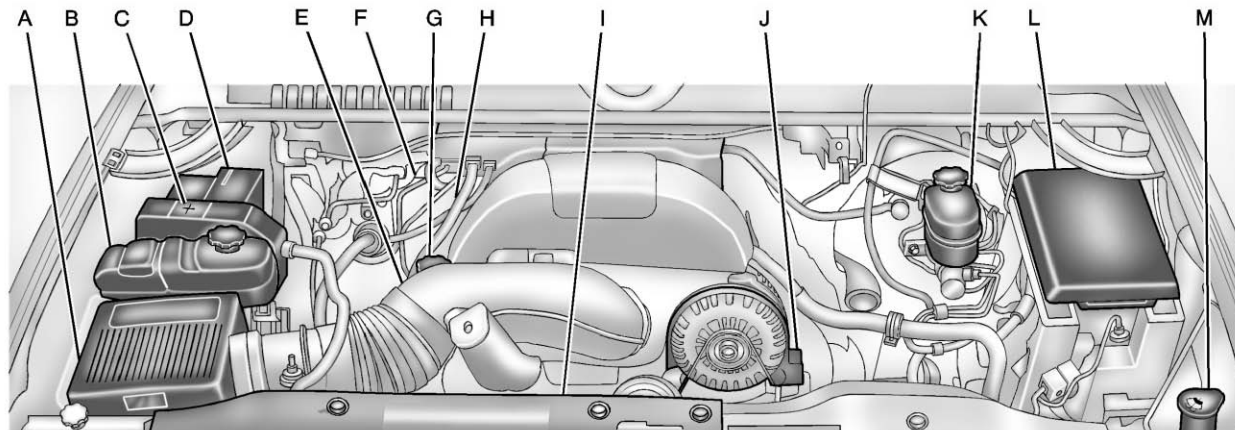

5.3 L V8 Engine Shown (4.3 L V6 Engine, 4.8 L V8 Engine, 6.0 L V8 Engine, and 6.2 L V8 Engine Similar)

## 10-6 Vehicle Care

---

- A. *Engine Air Cleaner/Filter* on page 10-15.
- B. *Coolant Surge Tank and Pressure Cap*. See *Cooling System* on page 10-16.
- C. *Positive (+) Terminal*. See *Jump Starting* on page 10-82.
- D. *Battery* on page 10-27.
- E. *Remote Negative (-) Terminal (Out of View)*. See *Jump Starting* on page 10-82.
- F. *Automatic Transmission Dipstick (Out of View)*. See “Checking the Fluid Level” under *Automatic Transmission Fluid (4-Speed Transmission)* on page 10-10 or *Automatic Transmission Fluid (6-Speed Transmission)* on page 10-12.
- G. *Engine Oil Fill Cap*. See “When to Add Engine Oil” under *Engine Oil* on page 10-6.
- H. *Engine Oil Dipstick (Out of View)*. See “Checking Engine Oil” under *Engine Oil* on page 10-6.
- I. *Engine Cooling Fan (Out of View)*. See *Cooling System* on page 10-16.
- J. *Power Steering Fluid Reservoir*. See *Power Steering Fluid* on page 10-23.
- K. *Brake Master Cylinder Reservoir*. See *Brake Fluid* on page 10-25.
- L. *Engine Compartment Fuse Block* on page 10-39.
- M. *Windshield Washer Fluid Reservoir*. See “Adding Washer Fluid” under *Washer Fluid* on page 10-23.
- If the vehicle has a diesel engine and/or an Allison Transmission, see the Duramax Diesel Supplement.

## Engine Oil

For diesel engine vehicles, see “Engine Oil” in the Duramax diesel supplement.

To ensure proper engine performance and long life, careful attention must be paid to engine oil. Following these simple, but important steps will help protect your investment:

- Always use engine oil approved to the proper specification and of the proper viscosity grade. See “Selecting the Right Engine Oil” in this section.
- Check the engine oil level regularly and maintain the proper oil level. See “Checking Engine Oil” and “When to Add Engine Oil” in this section.
- Change the engine oil at the appropriate time. See *Engine Oil Life System* on page 10-9.
- Always dispose of engine oil properly. See “What to Do with Used Oil” in this section.



## Checking Engine Oil

It is a good idea to check the engine oil level at each fuel fill. In order to get an accurate reading, the vehicle must be on level ground. The engine oil dipstick handle is a loop. See *Engine Compartment Overview* on page 10-5 for the location of the engine oil dipstick.

Obtaining an accurate oil level reading is essential:

1. If the engine has been running recently, turn off the engine and allow several minutes for the oil to drain back into the oil pan. Checking the oil level too soon after engine shutoff will not provide an accurate oil level reading.

### WARNING

The engine oil dipstick handle may be hot; it could burn you. Use a towel or glove to touch the dipstick handle.

2. Pull out the dipstick and clean it with a paper towel or cloth, then push it back in all the way. Remove it again, keeping the tip down, and check the level.

## When to Add Engine Oil



If the oil is below the cross-hatched area at the tip of the dipstick, add 1 L (1 qt) of the recommended oil and then recheck the level. See "Selecting the Right Engine Oil" in this section for an explanation of what kind of oil to use. For engine oil crankcase capacity, see *Capacities and Specifications* on page 12-2.

**Notice:** Do not add too much oil. Oil levels above or below the acceptable operating range shown on the dipstick are harmful

to the engine. If you find that you have an oil level above the operating range, i.e., the engine has so much oil that the oil level gets above the cross-hatched area that shows the proper operating range, the engine could be damaged. You should drain out the excess oil or limit driving of the vehicle and seek a service professional to remove the excess amount of oil.

See *Engine Compartment Overview* on page 10-5 for the location of the engine oil fill cap.

Add enough oil to put the level somewhere in the proper operating range. Push the dipstick all the way back in when through.

## Selecting the Right Engine Oil

Selecting the right engine oil depends on both the proper oil specification and viscosity grade. See *Recommended Fluids and Lubricants* on page 11-12.

### Specification

Use and ask for licensed engine oils with the dexos1<sup>®</sup> approved certification mark. Engine oils meeting the requirements for the vehicle should have the dexos™ 1 approved certification mark. This certification mark indicates that the oil has been approved to the dexos1 specification.



**Notice:** Failure to use the recommended engine oil or equivalent can result in engine damage not covered by the vehicle warranty. Check with your dealer or service provider on whether the oil is approved to the dexos1 specification.

### Viscosity Grade

SAE 5W-30 is the best viscosity grade for the vehicle. Do not use other viscosity grade oils such as SAE 10W-30, 10W-40, or 20W-50.

**Cold Temperature Operation:** In an area of extreme cold, where the temperature falls below  $-29^{\circ}\text{C}$  ( $-20^{\circ}\text{F}$ ), an SAE 0W-30 oil may be used. An oil of this viscosity grade will provide easier cold starting for the engine at extremely low temperatures. When selecting an oil of the appropriate viscosity grade, always select an oil of the correct specification. See "Specification" earlier in this section for more information.

### Engine Oil Additives/Engine Oil Flushes

Do not add anything to the oil. The recommended oils with the dexos specification and displaying the dexos certification mark are all that is needed for good performance and engine protection.

Engine oil system flushes are not recommended and could cause engine damage not covered by the vehicle warranty.

### What to Do with Used Oil

Used engine oil contains certain elements that can be unhealthy for your skin and could even cause cancer. Do not let used oil stay on your skin for very long. Clean your skin and nails with soap and water, or a good hand cleaner. Wash or properly dispose of clothing or rags containing used engine oil. See the manufacturer's warnings about the use and disposal of oil products.

Used oil can be a threat to the environment. If you change your own oil, be sure to drain all the oil from the filter before disposal. Never dispose of oil by putting it in the trash or pouring it on the ground, into sewers, or into streams or bodies of water. Recycle it by taking it to a place that collects used oil.

## Engine Oil Life System

### When to Change Engine Oil

This vehicle has a computer system that indicates when to change the engine oil and filter. This is based on a combination of factors which include engine revolutions, engine temperature, and miles driven. Based on driving conditions, the mileage at which an oil change is indicated can vary considerably. For the oil life system to work properly, the system must be reset every time the oil is changed.

On some vehicles, when the system has calculated that oil life has been diminished, a CHANGE ENGINE OIL SOON message comes on to indicate that an oil change is necessary. See *Engine Oil Messages on page 5-40*. Change the oil as soon as possible within the next 1 000 km (600 mi). It is possible that, if driving under the

best conditions, the oil life system might indicate that an oil change is not necessary for up to a year. The engine oil and filter must be changed at least once a year and, at this time, the system must be reset. For vehicles without the CHANGE ENGINE OIL SOON message, an oil change is needed when the OIL LIFE REMAINING percentage is near 0%. Your dealer has trained service people who will perform this work and reset the system. It is also important to check the oil regularly over the course of an oil drain interval and keep it at the proper level.

If the system is ever reset accidentally, the oil must be changed at 5 000 km (3,000 mi) since the last oil change. Remember to reset the oil life system whenever the oil is changed.

### How to Reset the Engine Oil Life System

Reset the system whenever the engine oil is changed so that the system can calculate the next engine oil change. Always reset the engine oil life to 100% after every oil change. It will not reset itself. To reset the system on most vehicles:

1. Display the OIL LIFE REMAINING on the DIC. If the vehicle does not have DIC buttons, the vehicle must be in P (Park) to access this display. See *Driver Information Center (DIC) on page 5-28*.
2. Press and hold the SET/RESET button on the DIC, or the trip odometer reset stem if the vehicle does not have DIC buttons, for more than five seconds. The oil life will change to 100%.

On all vehicles, the Engine Oil Life System can be reset as follows:

1. Turn the ignition to ON/RUN with the engine off.
2. Fully press the accelerator pedal slowly three times within five seconds.
3. Display the OIL LIFE REMAINING on the DIC. If the display shows 100%, the system is reset. See *Driver Information Center (DIC)* on page 5-28.

If the vehicle has a CHANGE ENGINE OIL SOON message and it comes back on when the vehicle is started and/or the OIL LIFE REMAINING is near 0%, the engine oil life system has not been reset. Repeat the procedure.

### Automatic Transmission Fluid (4-Speed Transmission)

#### When to Check and Change Automatic Transmission Fluid

A good time to check the automatic transmission fluid level is when the engine oil is changed.

Change the fluid and filter at the intervals listed in *Maintenance Schedule* on page 11-3 and be sure to use the transmission fluid listed in *Recommended Fluids and Lubricants* on page 11-12.

#### How to Check Automatic Transmission Fluid

Because this operation can be a little difficult, it may be best to have this done at the dealer service department.

If not taken to the dealer, be sure to follow all the instructions here or a false reading on the dipstick could result.

**Notice:** Too much or too little fluid can damage the transmission. Too much can mean that some of the fluid could come out and fall on hot engine parts or exhaust system parts, starting a fire. Too little fluid could cause the transmission to overheat. Be sure to get an accurate reading if checking the transmission fluid.

Wait at least 30 minutes before checking the transmission fluid level if you have been driving:

- When outside temperatures are above 32°C (90°F).
- At high speed for quite a while.
- In heavy traffic — especially in hot weather.
- While pulling a trailer.

To get the right reading, the fluid should be at normal operating temperature, which is 82°C to 93°C (180°F to 200°F).

Get the vehicle warmed up by driving about 24 km (15 miles) when outside temperatures are above 10°C (50°F). If it is colder than 10°C (50°F), drive the vehicle in 3 (Third) until the engine temperature gauge moves and then remains steady for 10 minutes.

A cold fluid check can be made after the vehicle has been sitting for eight hours or more with the engine off, but this is used only as a reference. Let the engine run at idle for five minutes if outside temperatures are 10°C (50°F) or more. If it is colder than 10°C (50°F), the engine may have to idle longer. Should the fluid level be low during this cold check, the fluid must be checked when hot before adding fluid. Checking the fluid hot will give you a more accurate reading of the fluid level.

### Checking the Fluid Level

Prepare the vehicle as follows:

1. Park the vehicle on a level place. Keep the engine running.

2. With the parking brake applied, place the shift lever in P (Park).
3. With your foot on the brake pedal, move the shift lever through each gear range, pausing for about three seconds in each range. Then, position the shift lever in P (Park).
4. Let the engine run at idle for three minutes or more.

Then, without shutting off the engine, follow these steps:



1. Locate the transmission dipstick handle with this graphic which is located at the rear of the engine compartment, on the passenger side of the vehicle.

See *Engine Compartment Overview* on page 10-5 for more information on location.

2. Flip the handle up, then pull out the dipstick and wipe it with a clean rag or paper towel.
3. Push it back in all the way, wait three seconds and then pull it back out again.



4. Check both sides of the dipstick, and read the lower level. The fluid level must be in the COLD area, below the cross-hatched area, for a cold check or in the HOT or cross-hatched area for a hot check. Be sure to keep the dipstick pointed down to get an accurate reading.
5. If the fluid level is in the acceptable range, push the dipstick back in all the way; then flip the handle down to lock the dipstick in place.

### Consistency of Readings

Always check the fluid level at least twice using the procedure described previously. Consistency (repeatable readings) is important to maintaining proper fluid level. If readings are still inconsistent, contact the dealer.

### How to Add Automatic Transmission Fluid

Refer to *Recommended Fluids and Lubricants on page 11-12* to determine what kind of transmission fluid to use.

Using a funnel, add fluid down the transmission dipstick tube only after checking the transmission fluid while it is hot. A cold check is used only as a reference. If the fluid level is low, add only enough of the proper fluid to bring the level up to the HOT area for a hot check.

It does not take much fluid, generally less than 0.5 Liter (1 Pint). Do not overfill.

**Notice:** Use of the incorrect automatic transmission fluid may damage the vehicle, and the damages may not be covered by the vehicle warranty. Always use the automatic transmission fluid listed in *Recommended Fluids and Lubricants on page 11-12*.

- After adding fluid, recheck the fluid level as described under “How to Check Automatic Transmission Fluid,” earlier in this section.
- When the correct fluid level is obtained, push the dipstick back in all the way; then flip the handle down to lock the dipstick in place.

### Automatic Transmission Fluid (6-Speed Transmission)

#### When to Check and Change Automatic Transmission Fluid

It is usually not necessary to check the transmission fluid level. The only reason for fluid loss is a transmission leak or overheated transmission. If a small leak is suspected, then use the following checking procedures to check the fluid level. However, if there is a large leak, then it may be necessary to have the vehicle towed to a dealer service department and have it repaired before driving the vehicle further.

**Notice:** Use of the incorrect automatic transmission fluid may damage the vehicle, and the damages may not be covered by the vehicle warranty. Always use the automatic transmission fluid listed in *Recommended Fluids and Lubricants on page 11-12*.

Change the fluid and filter at the scheduled maintenance intervals listed in *Maintenance Schedule* on page 11-3. Be sure to use the transmission fluid listed in *Recommended Fluids and Lubricants* on page 11-12.

### How to Check Automatic Transmission Fluid

**Notice:** Too much or too little fluid can damage the transmission. Too much can mean that some of the fluid could come out and fall on hot engine parts or exhaust system parts, starting a fire. Too little fluid could cause the transmission to overheat. Be sure to get an accurate reading if checking the transmission fluid.

Before checking the fluid level, prepare the vehicle as follows:

1. Start the engine and park the vehicle on a level surface. Keep the engine running.

2. Apply the parking brake and place the shift lever in P (Park).
3. With your foot on the brake pedal, move the shift lever through each gear range, pausing for about three seconds in each range. Then, move the shift lever back to P (Park).
4. Allow the engine to idle (500 – 800 rpm) for at least 1 minute. Slowly release the brake pedal.
5. Keep the engine running and press the Trip/Fuel button or trip odometer reset stem until TRANS TEMP (Transmission Temperature) displays on the Driver Information Center (DIC).
6. Using the TRANS TEMP reading, determine and perform the appropriate check procedure. If the TRANS TEMP reading is not within the required temperature ranges, allow the vehicle to cool, or operate the vehicle until the appropriate transmission fluid temperature is reached.

### Cold Check Procedure

Use this procedure only as a reference to determine if the transmission has enough fluid to be operated safely until a hot check procedure can be made. The hot check procedure is the most accurate method to check the fluid level. Perform the hot check procedure at the first opportunity. Use this cold check procedure to check fluid level when the transmission temperature is between 27°C and 32°C (80°F and 90°F).



## 10-14 Vehicle Care

1. Locate the transmission dipstick at the rear of the engine compartment, on the passenger side of the vehicle.

See *Engine Compartment Overview* on page 10-5 for more information.

2. Flip the handle up, then pull out the dipstick and wipe it with a clean rag or paper towel.
3. Install the dipstick by pushing it back in all the way; wait three seconds, and then pull it back out again.
4. Check both sides of the dipstick and read the lower level. Repeat the check procedure to verify the reading.



5. If the fluid level is below the COLD check band, add only enough fluid as necessary to bring the level into the COLD band. It does not take much fluid, generally less than 0.5 Liter (1 Pint). Do not overfill.
6. Perform a hot check at the first opportunity after the transmission reaches a normal operating temperature between 71°C to 93°C (160°F to 200°F).
7. If the fluid level is in the acceptable range, push the dipstick back in all the way, then flip the handle down to lock the dipstick in place.

### Hot Check Procedure

Use this procedure to check the transmission fluid level when the transmission fluid temperature is between 71°C and 93°C (160°F and 200°F).

The hot check is the most accurate method to check the fluid level. The hot check should be performed at

the first opportunity in order to verify the cold check. The fluid level rises as fluid temperature increases, so it is important to ensure the transmission temperature is within range.



1. Locate the transmission dipstick at the rear of the engine compartment, on the passenger side of the vehicle.

See *Engine Compartment Overview* on page 10-5 for more information.

2. Flip the handle up, then pull out the dipstick and wipe it with a clean rag or paper towel.
3. Install the dipstick by pushing it back in all the way; wait three seconds, and then pull it back out again.



4. Check both sides of the dipstick and read the lower level. Repeat the check procedure to verify the reading.



5. Safe operating level is within the HOT cross hatch band on the dipstick. If the fluid level is not within the HOT band, and the transmission temperature is between 71°C and 93°C (160°F and 200°F), add or drain fluid as necessary to bring the level into the HOT band. If the fluid level is low, add only enough fluid to bring the level into the HOT band. It does not take much fluid, generally less than 0.5 L (1 pint). Do not overfill.

6. If the fluid level is in the acceptable range, push the dipstick back in all the way, then flip the handle down to lock the dipstick in place.

### Consistency of Readings

Always check the fluid level at least twice using the procedure described previously. Consistency (repeatable readings) is important to maintaining proper fluid level. If readings are still inconsistent, contact the dealer.

### Engine Air Cleaner/Filter

If the vehicle has a diesel engine, see “Pickup Models” under “Engine Air Cleaner/Filter” in the Duramax® Diesel Supplement for the correct inspection and replacement procedures.

See *Engine Compartment Overview on page 10-5* for the location of the engine air cleaner/filter.

### When to Inspect the Engine Air Cleaner/Filter

Inspect the air cleaner/filter at the scheduled maintenance intervals and replace it at the first oil change after each 80 000 km (50,000 mi) interval. See *Maintenance Schedule on page 11-3* for more information. If driving on dusty/dirty conditions, inspect the filter at each engine oil change.

### How to Inspect the Engine Air Cleaner/Filter

To inspect the air cleaner/filter, remove the engine air cleaner/filter from the vehicle by following Steps 1 through 6. When the engine air cleaner/filter is removed, lightly shake it to release loose dust and dirt. If the engine air cleaner/filter remains covered with dirt, a new filter is required. Never use compressed air to clean the filter.

## 10-16 Vehicle Care

### Replacing the Engine Air Cleaner/ Filter



1. Locate the air cleaner/filter assembly. See *Engine Compartment Overview* on page 10-5.
2. Loosen the four screws on the cover of the housing and lift up the cover.

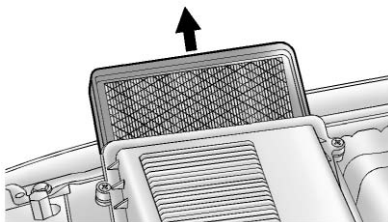

3. Remove the engine air cleaner/filter from the housing. Take care to dislodge as little dirt as possible.
4. Clean the engine air cleaner/filter sealing surfaces and the housing.
5. Inspect or replace the engine air cleaner/filter.
6. Reinstall the cover and tighten the screws.

### **WARNING**

Operating the engine with the air cleaner/filter off can cause you or others to be burned. The air cleaner not only cleans the air; it helps to stop flames if the engine backfires. Use caution when working on the engine and do not drive with the air cleaner/filter off.

### Cooling System

If the vehicle has the Duramax<sup>®</sup> Diesel engine, see the Duramax<sup>®</sup> Diesel Supplement for more information.

The cooling system allows the engine to maintain the correct working temperature.

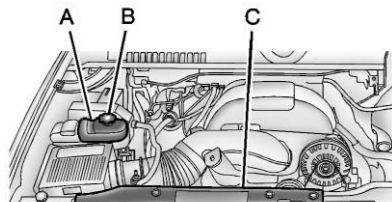

**5.3L Engine Shown (4.3L, 4.8L, 6.0L and, 6.2L Engines Similar)**

- A. Coolant Surge Tank
- B. Coolant Surge Tank Pressure Cap
- C. Engine Cooling Fan (Out of View)

**⚠ WARNING**

An electric engine cooling fan can start even when the engine is not running. To avoid injury, always keep hands, clothing, and tools away from any engine cooling fan.

**⚠ WARNING**

Heater and radiator hoses, and other engine parts, can be very hot. Do not touch them. If you do, you can be burned.

Do not run the engine if there is a leak. If you run the engine, it could lose all coolant. That could cause an engine fire, and you could be burned. Get any leak fixed before you drive the vehicle.

**Notice:** Using coolant other than DEX-COOL® can cause premature engine, heater core, or radiator corrosion. In addition, the engine coolant could require changing sooner, at 50 000 km (30,000 mi) or 24 months, whichever occurs first. Any repairs would not be covered by the vehicle warranty. Always use DEX-COOL (silicate-free) coolant in the vehicle.

**Engine Coolant**

The cooling system in the vehicle is filled with DEX-COOL® engine coolant. This coolant is designed to remain in the vehicle for 5 years or 240 000 km (150,000 mi), whichever occurs first.

The following explains the cooling system and how to check and add coolant when it is low. If there is a problem with engine overheating, see *Engine Overheating* on page 10-20.

**What to Use**

**⚠ WARNING**

Adding only plain water or some other liquid to the cooling system can be dangerous. Plain water and other liquids, can boil before the proper coolant mixture will. The coolant warning system is set for the proper coolant mixture. With plain water or the wrong

(Continued)

### WARNING (Continued)

mixture, the engine could get too hot but you would not get the overheat warning. The engine could catch fire and you or others could be burned. Use a 50/50 mixture of clean, drinkable water and DEX-COOL coolant.

Use a 50/50 mixture of clean, drinkable water and DEX-COOL coolant. If using this mixture, nothing else needs to be added. This mixture:

- Gives freezing protection down to  $-37^{\circ}\text{C}$  ( $-34^{\circ}\text{F}$ ), outside temperature
- Gives boiling protection up to  $129^{\circ}\text{C}$  ( $265^{\circ}\text{F}$ ), engine temperature
- Protects against rust and corrosion
- Will not damage aluminum parts

- Helps keep the proper engine temperature

**Notice:** If improper coolant mixture, inhibitors, or additives are used in the vehicle cooling system, the engine could overheat and be damaged. Too much water in the mixture can freeze and crack engine cooling parts. The repairs would not be covered by the warranty. Use only the proper mixture of engine coolant for the cooling system. See *Recommended Fluids and Lubricants on page 11-12*.

Never dispose of engine coolant by putting it in the trash, pouring it on the ground, or into sewers, streams, or bodies of water. Have the coolant changed by an authorized service center, familiar with legal requirements regarding used coolant disposal. This will help protect the environment and your health.

### Checking Coolant

The coolant surge tank is located in the engine compartment on the passenger side of the vehicle. See *Engine Compartment Overview on page 10-5* for more information on location.

The vehicle must be on a level surface when checking the coolant level.

Check to see if coolant is visible in the coolant surge tank. If the coolant inside the coolant surge tank is boiling, do not do anything else until it cools down. If coolant is visible but the coolant level is not at or above the FULL COLD mark, add a 50/50 mixture of clean, drinkable water and DEX-COOL coolant at the coolant surge tank, but be sure the cooling system is cool before this is done.

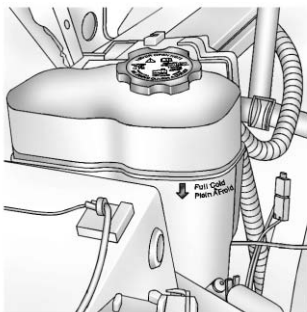

The coolant level should be at or above the FULL COLD mark. If it is not, there may be a leak in the cooling system.

### How to Add Coolant to the Coolant Surge Tank for Gasoline Engines

If the vehicle has a diesel engine, see “Cooling System” in the Duramax Diesel Supplement for the proper coolant fill procedure.

#### WARNING

You can be burned if you spill coolant on hot engine parts. Coolant contains ethylene glycol and it will burn if the engine parts are hot enough. Do not spill coolant on a hot engine.

**Notice:** This vehicle has a specific coolant fill procedure. Failure to follow this procedure could cause the engine to overheat and be severely damaged.

#### WARNING

Steam and scalding liquids from a hot cooling system can blow out and burn you badly. Never turn the cap when the cooling system, including the surge tank pressure cap, is hot. Wait for the cooling system and surge tank pressure cap to cool.

If no coolant is visible in the surge tank, add coolant as follows:



1. Remove the coolant surge tank pressure cap when the cooling system, including the coolant surge tank pressure cap and upper radiator hose, is no longer hot.

Turn the pressure cap slowly counterclockwise about one full turn. If a hiss is heard, wait for that to stop. A hiss means there is still some pressure left.

2. Keep turning the pressure cap slowly, and remove it.

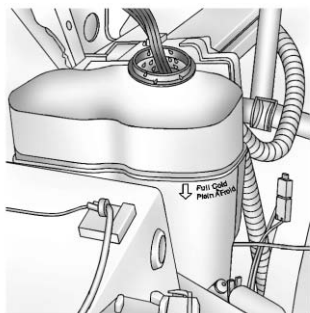

3. Fill the coolant surge tank with the proper mixture to the FULL COLD mark.
4. With the coolant surge tank pressure cap off, start the engine and let it run until the engine coolant temperature gauge indicates approximately 90°C (195°F).

By this time, the coolant level inside the coolant surge tank may be lower. If the level is lower, add more of the proper

mixture to the coolant surge tank until the level reaches the FULL COLD mark.

5. Replace the pressure cap tightly.
6. Verify coolant level after the engine is shut off and the coolant is cold. If necessary, repeat coolant fill procedure Steps 1 through 6.

**Notice:** If the pressure cap is not tightly installed, coolant loss and possible engine damage may occur. Be sure the cap is properly and tightly secured.

### Engine Overheating

If the vehicle has the Duramax<sup>®</sup> Diesel engine, see the Duramax Diesel Supplement for more information.

The vehicle has several indicators to warn of engine overheating.

There is a coolant temperature gauge on the vehicle's instrument panel. See *Engine Coolant Temperature Gauge* on page 5-15.

In addition, there are ENGINE OVERHEATED STOP ENGINE, ENGINE OVERHEATED IDLE ENGINE, and ENGINE POWER IS REDUCED messages in the Driver Information Center (DIC) on the instrument panel. See *Engine Cooling System Messages* on page 5-39 and *Engine Power Messages* on page 5-40.

If the decision is made not to lift the hood when this warning appears, get service help right away. See *Roadside Assistance Program (Mexico)* on page 13-7 or *Roadside Assistance Program (U.S. and Canada)* on page 13-11.

If the decision is made to lift the hood, make sure the vehicle is parked on a level surface.

Then check to see if the engine cooling fans are running. If the engine is overheating, both fans should be running. If they are not, do not continue to run the engine and have the vehicle serviced.

**Notice:** Running the engine without coolant may cause damage or a fire. Vehicle damage would not be covered by the warranty. See *Overheated Engine Protection Operating Mode on page 10-22* for information on driving to a safe place in an emergency.

**If Steam is Coming from the Engine Compartment**

 **WARNING**

Steam from an overheated engine can burn you badly, even if you just open the hood. Stay away from the engine if you see or hear steam coming from it. Turn it off and get everyone away from the vehicle until it cools down. Wait until there is no sign of steam or coolant before you open the hood.

(Continued)

**WARNING (Continued)**

If you keep driving when the vehicles engine is overheated, the liquids in it can catch fire. You or others could be badly burned. Stop the engine if it overheats, and get out of the vehicle until the engine is cool.

See *Overheated Engine Protection Operating Mode on page 10-22* for information on driving to a safe place in an emergency.

**If No Steam is Coming from the Engine Compartment**

The ENGINE OVERHEATED STOP ENGINE or the ENGINE OVERHEATED IDLE ENGINE message, along with a low coolant condition, can indicate a serious problem.

If there is an engine overheat warning, but no steam is seen or heard, the problem may not be too serious. Sometimes the engine can get a little too hot when the vehicle:

- Climbs a long hill on a hot day
- Stops after high-speed driving
- Idles for long periods in traffic
- Tows a trailer; see *Trailer Towing on page 9-73*.

If the ENGINE OVERHEATED STOP ENGINE or the ENGINE OVERHEATED IDLE ENGINE message appears with no sign of steam, try this for a minute or so:

1. Turn the air conditioning off.
2. Turn the heater on to the highest temperature and to the highest fan speed. Open the windows as necessary.
3. If stopped in a traffic jam, apply the brake, shift to N (Neutral); otherwise, shift to the highest gear while driving — D (Drive) or 3 (Third).

If the temperature overheat gauge is no longer in the overheat zone or an overheat warning no longer displays, the vehicle can be driven. Continue to drive the vehicle slowly for about 10 minutes. Keep a safe vehicle distance from the vehicle in front. If the warning does not come back on, continue to drive normally.

If the warning continues, pull over, stop, and park the vehicle right away.

If there is no sign of steam, idle the engine for five minutes while parked. If the warning is still displayed, turn off the engine until it cools down. Also, see "Overheated Engine Protection Operating Mode" later in this section.

### Overheated Engine Protection Operating Mode

If an overheated engine condition exists and the ENGINE POWER IS REDUCED message displays, an

overheat protection mode which alternates firing groups of cylinders helps to prevent engine damage. In this mode, a loss in power and engine performance will be noticed. This operating mode allows the vehicle to be driven to a safe place in an emergency. Driving extended km (mi) and/or towing a trailer in the overheat protection mode should be avoided.

**Notice:** After driving in the overheated engine protection operating mode, to avoid engine damage, allow the engine to cool before attempting any repair. The engine oil will be severely degraded. Repair the cause of coolant loss, change the oil and reset the oil life system. See *Engine Oil on page 10-6.*

### Engine Fan

If the vehicle has a clutched engine cooling fan, when the clutch is engaged, the fan spins faster to provide more air to cool the engine.

In most everyday driving conditions, the fan is spinning slower and the clutch is not fully engaged. This improves fuel economy and reduces fan noise. Under heavy vehicle loading, trailer towing, and/or high outside temperatures, the fan speed increases as the clutch more fully engages, so an increase in fan noise may be heard. This is normal and should not be mistaken as the transmission slipping or making extra shifts. It is merely the cooling system functioning properly. The fan will slow down when additional cooling is not required and the clutch disengages.

This fan noise may also be heard when starting the engine. It will go away as the fan clutch partially disengages.

If the vehicle has electric cooling fans, the fans may be heard spinning at low speed during most everyday driving. The fans may turn off if no cooling is required. Under heavy vehicle loading, trailer towing, high outside temperatures,



or operation of the air conditioning system, the fans may change to high speed and an increase in fan noise may be heard. This is normal and indicates that the cooling system is functioning properly. The fans will change to low speed when additional cooling is no longer required.

## Power Steering Fluid

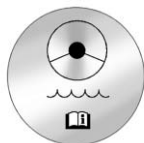

See *Engine Compartment Overview* on page 10-5 for reservoir location.

### When to Check Power Steering Fluid

It is not necessary to regularly check power steering fluid unless there is a leak suspected in the system or an unusual noise is

heard. A fluid loss in this system could indicate a problem. Have the system inspected and repaired.

### How to Check Power Steering Fluid

To check the power steering fluid:

1. Turn the key off and let the engine compartment cool down.
2. Wipe the cap and the top of the reservoir clean.
3. Unscrew the cap and wipe the dipstick with a clean rag.
4. Replace the cap and completely tighten it.
5. Remove the cap again and look at the fluid level on the dipstick.

The level should be at the FULL COLD mark. If necessary, add only enough fluid to bring the level up to the mark.

### What to Use

To determine what kind of fluid to use, see *Recommended Fluids and Lubricants* on page 11-12. Always use the proper fluid.

**Notice:** Use of the incorrect fluid may damage the vehicle and the damages may not be covered by the vehicle's warranty. Always use the correct fluid listed in *Recommended Fluids and Lubricants* on page 11-12.

### Washer Fluid

#### What to Use

When windshield washer fluid needs to be added, be sure to read the manufacturer's instructions before use. Use a fluid that has sufficient protection against freezing in an area where the temperature may fall below freezing.

### Adding Washer Fluid

The vehicle has a low washer fluid message on the DIC that comes on when the washer fluid is low. The message is displayed for 15 seconds at the start of each ignition cycle. When the WASHER FLUID LOW ADD FLUID message displays, washer fluid will need to be added to the windshield washer fluid reservoir.



Open the cap with the washer symbol on it. Add washer fluid until the tank is full. See *Engine Compartment Overview* on page 10-5 for reservoir location.

### Notice

- **When using concentrated washer fluid, follow the manufacturer instructions for adding water.**
- **Do not mix water with ready-to-use washer fluid. Water can cause the solution to freeze and damage the washer fluid tank and other parts of the washer system.**
- **Fill the washer fluid tank only three-quarters full when it is very cold. This allows for fluid expansion if freezing occurs, which could damage the tank if it is completely full.**
- **Do not use engine coolant (antifreeze) in the windshield washer. It can damage the windshield washer system and paint.**

### Brakes

This vehicle has front disc brakes and could have rear drum brakes or rear disc brakes.

Disc brake pads have built-in wear indicators that make a high-pitched warning sound when the brake pads are worn and new pads are needed. The sound can come and go or be heard all the time the vehicle is moving, except when applying the brake pedal firmly.

#### WARNING

The brake wear warning sound means that soon the brakes will not work well. That could lead to a crash. When the brake wear warning sound is heard, have the vehicle serviced.

**Notice:** Continuing to drive with worn-out brake pads could result in costly brake repair.

Some driving conditions or climates can cause a brake squeal when the brakes are first applied or lightly applied. This does not mean something is wrong with the brakes.

Properly torqued wheel nuts are necessary to help prevent brake pulsation. When tires are rotated, inspect brake pads for wear and evenly tighten wheel nuts in the proper sequence to torque specifications in *Capacities and Specifications on page 12-2*.

If the vehicle has rear drum brakes, they do not have wear indicators, but if a rear brake rubbing noise is heard, have the rear brake linings inspected immediately. Rear brake drums should be removed and inspected each time the tires are removed for rotation or changing. Drum brakes have an inspection hole to inspect lining wear during scheduled maintenance. When the front brake pads are replaced, have the rear brakes inspected, too.

Brake linings should always be replaced as complete axle sets.

### **Brake Pedal Travel**

See your dealer if the brake pedal does not return to normal height, or if there is a rapid increase in pedal travel. This could be a sign that brake service might be required.

### **Brake Adjustment**

Every time the brakes are applied, with or without the vehicle moving, the brakes adjust for wear.

### **Replacing Brake System Parts**

The braking system on a vehicle is complex. Its many parts have to be of top quality and work well together if the vehicle is to have really good braking. The vehicle was designed and tested with top-quality brake parts. When parts of the braking system are replaced, be sure to get new, approved replacement parts.

If this is not done, the brakes might not work properly. For example, installing disc brake pads that are wrong for the vehicle, can change the balance between the front and rear brakes — for the worse. The braking performance expected can change in many other ways if the wrong replacement brake parts are installed.

### **Brake Fluid**



The brake master cylinder reservoir is filled with DOT 3 brake fluid. See *Engine Compartment Overview on page 10-5* for the location of the reservoir.

There are only two reasons why the brake fluid level in the reservoir might go down:

- The brake fluid level goes down because of normal brake lining wear. When new linings are installed, the fluid level goes back up.
- A fluid leak in the brake hydraulic system can also cause a low fluid level. Have the brake hydraulic system fixed, since a leak means that sooner or later the brakes will not work well.

Do not top off the brake fluid. Adding fluid does not correct a leak. If fluid is added when the linings are worn, there will be too much fluid when new brake linings are installed. Add or remove brake fluid, as necessary, only when work is done on the brake hydraulic system.

### **WARNING**

If too much brake fluid is added, it can spill on the engine and burn, if the engine is hot enough. You or others could be burned, and the vehicle could be damaged. Add brake fluid only when work is done on the brake hydraulic system. See “Checking Brake Fluid” in this section.

When the brake fluid falls to a low level, the brake warning light comes on. See *Brake System Warning Light on page 5-23*.

Refer to the Maintenance Schedule to determine when to check the brake fluid. See *Maintenance Schedule on page 11-3*.

### **Checking Brake Fluid**

Check brake fluid by looking at the brake fluid reservoir. See *Engine Compartment Overview on page 10-5*.



The fluid level should be above MIN. If it is not, have the brake hydraulic system checked to see if there is a leak.

After work is done on the brake hydraulic system, make sure the level is above the MIN but not over the MAX mark.

### **What to Add**

Use only new DOT 3 brake fluid from a sealed container. See *Recommended Fluids and Lubricants on page 11-12*.

Always clean the brake fluid reservoir cap and the area around the cap before removing it. This helps keep dirt from entering the reservoir.

 **WARNING**

With the wrong kind of fluid in the brake hydraulic system, the brakes might not work well. This could cause a crash. Always use the proper brake fluid.

**Notice**

- **Using the wrong fluid can badly damage brake hydraulic system parts. For example, just a few drops of mineral-based oil, such as engine oil, in the brake hydraulic system can damage brake hydraulic system parts so badly that they will have to be replaced. Do not let someone put in the wrong kind of fluid.**

- **If brake fluid is spilled on the vehicle's painted surfaces, the paint finish can be damaged. Be careful not to spill brake fluid on the vehicle. If you do, wash it off immediately.**

**Battery**

If the vehicle is a Hybrid, see the Hybrid Supplement for more information.

This vehicle has a maintenance free battery (or batteries). Refer to the replacement number on the original battery label when a new battery is needed. See *Engine Compartment Overview on page 10-5* for battery location.

 **WARNING**

Battery posts, terminals, and related accessories contain lead and lead compounds, chemicals  
(Continued)

**WARNING (Continued)**

known to the State of California to cause cancer and reproductive harm. Wash hands after handling.

**Vehicle Storage**

 **WARNING**

Batteries have acid that can burn you and gas that can explode. You can be badly hurt if you are not careful. See *Jump Starting on page 10-82* for tips on working around a battery without getting hurt.

**Infrequent Usage:** Remove the black, negative (-) cable from the battery to keep the battery from running down.

**Extended Storage:** Remove the black, negative (-) cable from the battery or use a battery trickle charger.

## Four-Wheel Drive

### Transfer Case

#### When to Check Lubricant

Refer to *Maintenance Schedule on page 11-3* to determine when to check the lubricant.

#### How to Check Lubricant

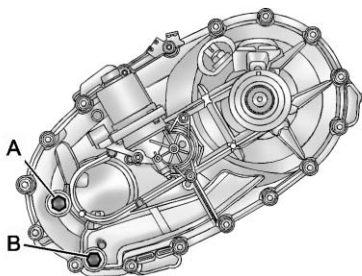

#### Electric Shift Transfer Case

- A. Fill Plug
- B. Drain Plug

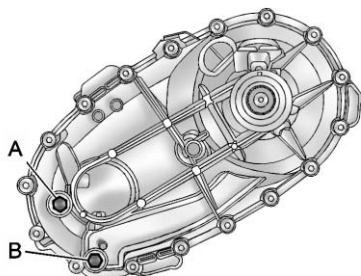

#### Manual Shift Transfer Case

- A. Fill Plug
- B. Drain Plug

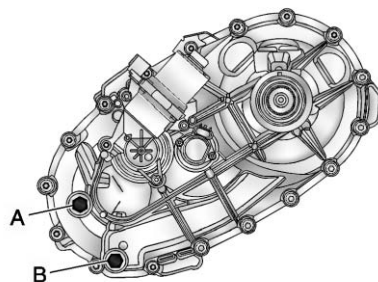

#### Active Transfer Case

- A. Fill Plug
- B. Drain Plug

To get an accurate reading, the vehicle should be on a level surface.

If the level is below the bottom of the fill plug (A) hole, located on the transfer case, some lubricant will need to be added. Add enough lubricant to raise the level to the bottom of the fill plug (A) hole. Use care not to overtighten the plug.

### When to Change Lubricant

Refer to *Maintenance Schedule* on page 11-3 to determine how often to change the lubricant.

### What to Use

Refer to *Recommended Fluids and Lubricants* on page 11-12 to determine what kind of lubricant to use.

## Front Axle

### When to Check and Change Lubricant

It is not necessary to regularly check front axle fluid unless a leak is suspected, or an unusual noise is heard. A fluid loss could indicate a problem. Have it inspected and repaired.

### How to Check Lubricant

To get an accurate reading, the vehicle should be on a level surface.

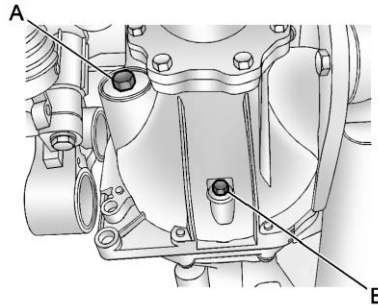

**1500 Series**

- A. Fill Plug
- B. Drain Plug

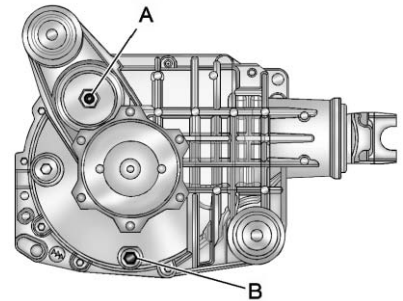

**All Except 1500 Series**

- A. Fill Plug
- B. Drain Plug
- When the differential is cold, add enough lubricant to raise the level from 0 mm (0 in) to 3.2 mm (1/8 in) below the fill plug (A) hole.
- When the differential is at operating temperature (warm), add enough lubricant to raise the level to the bottom of the fill plug (A) hole.

### What to Use

Refer to *Recommended Fluids and Lubricants* on page 11-12 to determine what kind of lubricant to use.

### Rear Axle

#### When to Check Lubricant

It is not necessary to regularly check rear axle fluid unless a leak is suspected or an unusual noise is heard. A fluid loss could indicate a problem. Have it inspected and repaired.

All axle assemblies are filled by volume of fluid during production. They are not filled to reach a certain level. When checking the fluid level on any axle, variations in the readings can be caused by factory fill differences between the minimum and the maximum fluid volume. Also, if a vehicle has just been driven before checking the fluid level, it may appear lower than normal because fluid has traveled

out along the axle tubes and has not drained back to the sump area. Therefore, a reading taken five minutes after the vehicle has been driven will appear to have a lower fluid level than a vehicle that has been stationary for an hour or two. Remember that the rear axle assembly must be supported to get a true reading.

#### How to Check Lubricant

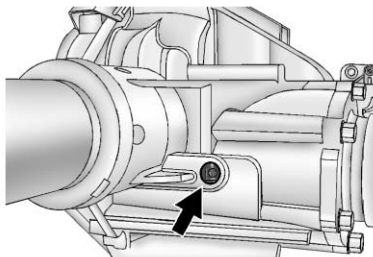

**2500HD with 6.0 L**

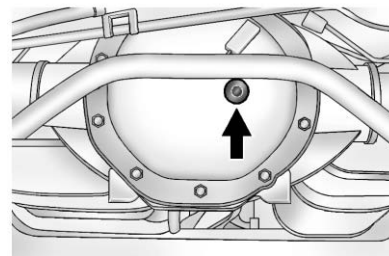

#### All Other Series and Engines

To get an accurate reading, the vehicle should be on a level surface.

- For all 4.3 L, 4.8 L and 5.3 L 1500 Series applications, the proper level is 1.0 mm to 19.0 mm (0.04 in to 0.7 in) below the bottom of the fill hole, located on the rear axle. Add only enough fluid to reach the proper level.



- For all 6.0 L and 6.2 L 1500 Series applications, the proper level is from 15 mm to 40 mm (0.6 in to 1.6 in) below the bottom of the fill plug hole, located on the rear axle. Add only enough fluid to reach the proper level.
- For all 6.0 L 2500HD Series applications, the proper level is from 0 mm to 13 mm (0 to 0.5 in) below the bottom of the fill plug hole, located on the rear axle. Add only enough fluid to reach the proper level.
- For all 6.6 L Duramax Diesel 2500HD Series applications and all 3500 Series applications, the proper level is from 17 mm to 21 mm (0.6 in to 0.8 in) below the bottom of the fill plug hole, located on the rear axle. Add only enough fluid to reach the proper level.

### What to Use

Refer to *Recommended Fluids and Lubricants* on page 11-12 to determine what kind of lubricant to use.

### Noise Control System

The following information relates to compliance with federal noise emission standards for vehicles with a Gross Vehicle Weight Rating (GVWR) of more than 4 536 kg (10,000 lbs). The noise control system warranty is given in your warranty booklet.

These standards apply only to vehicles sold in the United States.

Federal law prohibits the following acts or the causing thereof:

1. The removal or rendering inoperative by any person, other than for purposes of maintenance, repair or replacement, of any device or element of design incorporated into any new vehicle for the

purpose of noise control, prior to its sale or delivery to the ultimate purchaser or while it is in use; or

2. The use of the vehicle after such device or element of design has been removed or rendered inoperative by any person.

Among those acts presumed to constitute tampering are the acts listed below.

#### Insulation:

Removal of the noise shields or any underhood insulation.

#### Engine:

Removal or rendering engine speed governor, if the vehicle has one, inoperative so as to allow engine speed to exceed manufacturer specifications.

#### Fan and Drive:

- Removal of fan clutch, if the vehicle has one, or rendering clutch inoperative.

## 10-32 Vehicle Care

---

- Removal of the fan shroud, if the vehicle has one.

### Air Intake:

- Removal of the air cleaner silencer.
- Modification of the air cleaner.

### Exhaust:

- Removal of the muffler and/or resonator.
- Removal of the exhaust pipes and exhaust pipe clamps.

## Starter Switch Check

### WARNING

When you are doing this inspection, the vehicle could move suddenly. If the vehicle moves, you or others could be injured.

1. Before starting this check, be sure there is enough room around the vehicle.

2. Firmly apply both the parking brake and the regular brake. See *Parking Brake on page 9-51*.

Do not use the accelerator pedal, and be ready to turn off the engine immediately if it starts.

3. Try to start the engine in each gear. The vehicle should start only in P (Park) or N (Neutral). If the vehicle starts in any other position, contact your dealer for service.

## Automatic Transmission Shift Lock Control Function Check

### WARNING

When you are doing this inspection, the vehicle could move suddenly. If the vehicle moves, you or others could be injured.

1. Before starting this check, be sure there is enough room around the vehicle. It should be parked on a level surface.
2. Firmly apply the parking brake. See *Parking Brake on page 9-51*.

Be ready to apply the regular brake immediately if the vehicle begins to move.

3. With the engine off, turn the ignition on, but do not start the engine. Without applying the regular brake, try to move the shift lever out of P (Park) with normal effort. If the shift lever moves out of P (Park), contact your dealer for service.

## Ignition Transmission Lock Check

While parked, and with the parking brake set, try to turn the ignition to LOCK/OFF in each shift lever position.

- The ignition should turn to LOCK/OFF only when the shift lever is in P (Park).
- The ignition key should come out only in LOCK/OFF.

Contact your dealer if service is required.

## Park Brake and P (Park) Mechanism Check

### WARNING

When you are doing this check, the vehicle could begin to move. You or others could be injured and property could be damaged. Make sure there is room in front of the vehicle in case it begins to roll. Be ready to apply the regular brake at once should the vehicle begin to move.

Park on a fairly steep hill, with the vehicle facing downhill. Keeping your foot on the regular brake, set the parking brake.

- To check the parking brake's holding ability: With the engine running and the transmission in N (Neutral), slowly remove foot pressure from the regular brake pedal. Do this until the vehicle is held by the parking brake only.
- To check the P (Park) mechanism's holding ability: With the engine running, shift to P (Park). Then release the parking brake followed by the regular brake.

Contact your dealer if service is required.

## Wiper Blade Replacement

Windshield wiper blades should be inspected for wear or cracking. See *Maintenance Schedule* on page 11-3 for more information on wiper blade inspection.

Replacement blades come in different types and are removed in different ways. To remove the wiper blade:

1. Pull the windshield wiper arm connector away from the windshield.

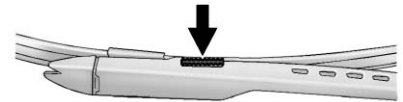

2. Squeeze the grooved areas on each side of the blade, and turn the blade assembly away from the arm connector.

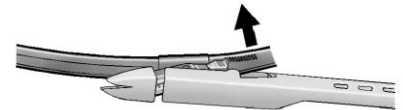

3. Install the new blade onto the arm connector and make sure the grooved areas are fully set in the locked position.

For the proper type and size, see *Maintenance Replacement Parts on page 11-14*.

### Glass Replacement

If the windshield or front side glass must be replaced, see your dealer to determine the correct replacement glass.

### Headlamp Aiming

Headlamp aim has been preset and should need no further adjustment.

If the vehicle is damaged in a crash, the headlamp aim may be affected. If adjustment to the headlamps is necessary, see your dealer.

### Bulb Replacement

For the proper type of replacement bulbs, see *Replacement Bulbs on page 10-38*.

For any bulb-changing procedure not listed in this section, contact your dealer.

### Halogen Bulbs

 **WARNING**

Halogen bulbs have pressurized gas inside and can burst if you drop or scratch the bulb. You or others could be injured. Be sure to read and follow the instructions on the bulb package.

## Headlamps, Front Turn Signal, Sidemarker, and Parking Lamps

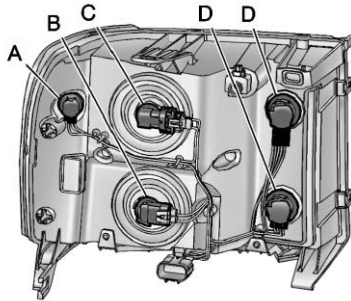

- A. Side Marker Lamp
- B. High-Beam Headlamp
- C. Low-Beam Headlamp
- D. Park/Turn Signal Lamp

To replace one of these bulbs:

1. Open the hood. See *Hood* on page 10-4

2. When replacing a driver side bulb on a vehicle with dual batteries, see your dealer.
3. When replacing a bulb on the passenger side, remove the Engine Air Cleaner cover. See *Engine Air Cleaner/Filter* on page 10-15.
4. Reach in and access the bulb sockets from inside the engine compartment.
5. Turn the bulb socket counterclockwise to remove it from the headlamp assembly and pull it straight out.
6. Unplug the electrical connector from the old bulb by releasing the clips on the bulb socket.
7. Replace it with a new bulb.
8. Plug in the electrical connector.
9. Reinstall the new bulb socket into the headlamp assembly and turn it clockwise to secure.

## Pick-Up Box Identification and Fender Marker Lamps

The pick-up box identification lamps are LEDs. For replacement of the LED lighting assembly contact your dealer.

To replace a pickup box fender marker lamp bulb:

1. Press the tab from the back to remove the lamp.
2. Turn the bulb socket counterclockwise to remove from the lamp assembly.
3. Gently pry the bulb from the socket.
4. Install the new bulb in socket.
5. Reinstall socket into lamp assembly.
6. Reinstall the lamp assembly.

## Taillamps (Chassis Cab Models)

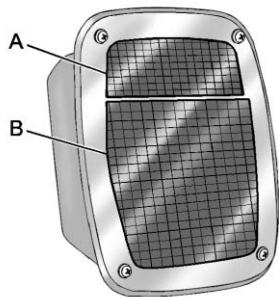

- A. Backup Lamp
- B. Stoplamp/Taillamp/Turn Signal Lamp

To replace one of these bulbs:

1. Remove the four screws.
2. Lift the lens off the lamp assembly.
3. Turn the old bulb counterclockwise and pull it straight out from the socket.

4. Install a new bulb into the socket, turn it clockwise, and press it in until it is tight.
5. Reinstall the lens and the four screws.

## Taillamps, Turn Signal, Stoplamps, and Back-Up Lamps

To replace a taillamp assembly bulb:

1. Open the tailgate. See *Tailgate* on page 2-9 for more information.

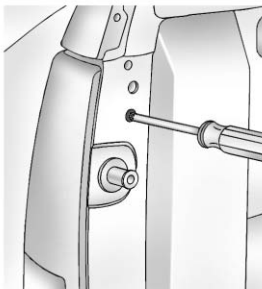

2. Remove the two taillamp assembly screws near the tailgate latch.
3. Pull the taillamp assembly rearward until the outer pins on the taillamp assembly disengage from the vehicle.

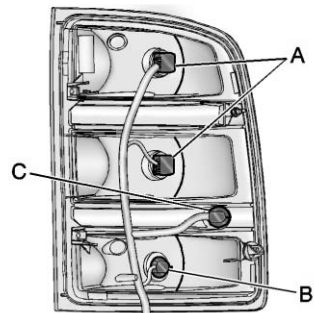

- A. Stoplamp/Turn Signal Lamp/Taillamp
  - B. Back-up Lamp
  - C. Sidemarker Lamp
4. Turn the bulb socket counterclockwise to remove it from the taillamp housing.

5. Pull the old bulb straight out from the socket.
6. Press a new bulb into the socket and turn the socket clockwise into the taillamp housing.
7. Reinstall the taillamp assembly.

### Center High-Mounted Stoplamp (CHMSL) and Cargo Lamp

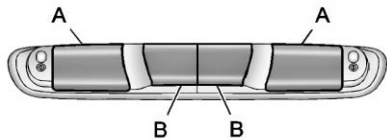

- A. Cargo Lamp
- B. Center High-Mounted Stoplamp (CHMSL) Bulb

To replace one of these bulbs:



1. Remove the two screws and lift off the lamp assembly.
2. On the reverse side of the lamp assembly, remove the bulb socket by turning it one quarter turn counterclockwise and pull it straight out.
3. Remove the bulb by pulling it straight out of the socket.
4. Install the bulb by pushing the bulb straight into the socket.
5. Install the bulb socket into the lamp assembly by turning it one quarter turn clockwise.
6. Reinstall the lamp assembly and tighten the screws.

### License Plate Lamp

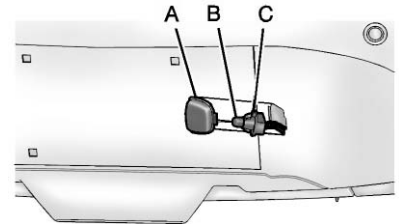

- A. License Plate Lamp Housing
- B. Bulb
- C. Bulb Socket

To replace one of these bulbs:

1. Using a small flat-bladed tool, insert the blade end at the back edge of the rear license plate lamp housing (A).
2. Gently push forward while lifting the back edge of the lamp housing from the bumper opening.

- Turn the bulb socket (C) one-quarter turn to release the bulb socket from the lamp housing (A).
- Pull the bulb (B) from the bulb socket (C).
- Reverse the steps to install.

### Replacement Bulbs

Exterior Lamp	Bulb Number
Back-up Lamp	3047K
Back-up Lamp*	1156
Cargo Lamp and Center High-Mounted Stoplamp (CHMSL)	912
Fender Marker	W5WLL
Front Turn Signal Lamp, Sidemarker Lamp, and Parking Lamp	3157A

Exterior Lamp	Bulb Number
High-Beam Headlamp	9005
Low-Beam Headlamp	H11
License Plate Lamp	168
Stoplamp/Taillamp/ Turn Signal Lamp	3047K
Sidemarker Lamp	194
Stoplamp/Turn Signal Lamp/ Taillamp*	1157
* Chassis Cab Models	

For replacement bulbs not listed here, contact your dealer.

## Electrical System

### Electrical System Overload

The vehicle has fuses and circuit breakers to protect against an electrical system overload.

When the current electrical load is too heavy, the circuit breaker opens and closes, protecting the circuit until the current load returns to normal or the problem is fixed. This greatly reduces the chance of circuit overload and fire caused by electrical problems.

Fuses and circuit breakers protect power devices in the vehicle.

Replace a bad fuse with a new one of the identical size and rating.

If there is a problem on the road and a fuse needs to be replaced, the same amperage fuse can be borrowed. Choose some feature of the vehicle that is not needed to use and replace it as soon as possible.



## Headlamp Wiring

An electrical overload may cause the lamps to go on and off, or in some cases to remain off. Have the headlamp wiring checked right away if the lamps go on and off or remain off.

## Windshield Wipers

If the wiper motor overheats due to heavy snow or ice, the windshield wipers will stop until the motor cools and will then restart.

Although the circuit is protected from electrical overload, overload due to heavy snow or ice may cause wiper linkage damage. Always clear ice and heavy snow from the windshield before using the windshield wipers.

If the overload is caused by an electrical problem and not snow or ice, be sure to get it fixed.

## Fuses and Circuit Breakers

If the vehicle is a hybrid, see the hybrid supplement for more information.

The wiring circuits in the vehicle are protected from short circuits by a combination of fuses, circuit breakers and fusible thermal links. This greatly reduces the chance of fires caused by electrical problems.

Look at the silver-colored band inside the fuse. If the band is broken or melted, replace the fuse. Be sure you replace a bad fuse with a new one of the identical size and rating.

If you ever have a problem on the road and don't have a spare fuse, you can borrow one that has the same amperage. Just pick some feature of your vehicle that you can get along without— like the radio or accessory power outlet— and use its fuse, if it is the correct amperage. Replace it as soon as you can.

## Engine Compartment Fuse Block

If the vehicle has a diesel engine, see the Duramax Diesel supplement for more information.

If the vehicle is a hybrid, see the hybrid supplement for more information.

The Engine Compartment Fuse Block is located in the engine compartment, on the driver side of the vehicle.

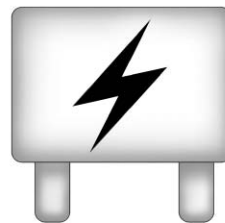

## 10-40 Vehicle Care

Lift the cover to access the fuse block.

**Notice:** Spilling liquid on any electrical component on the vehicle may damage it. Always keep the covers on any electrical component.

To remove fuses, hold the end of the fuse between your thumb and index finger and pull straight out.

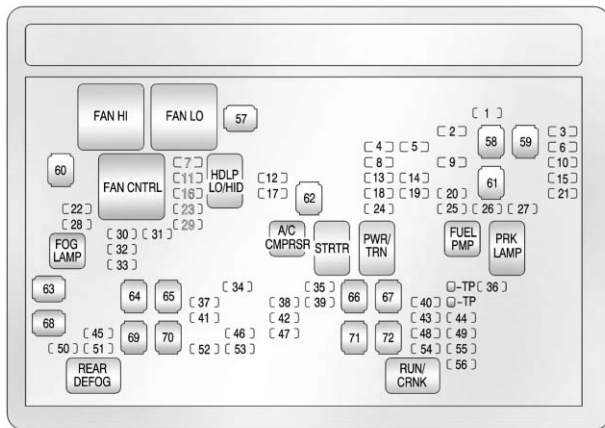

Fuses	Usage
1	Right Trailer Stop/ Turn Lamp

Fuses	Usage
2	Electronic Suspension Control, Automatic Level Control Exhaust
3	Left Trailer Stop/ Turn Lamp

<b>Fuses</b>	<b>Usage</b>
4	Engine Controls
5	Engine Control Module, Throttle Control
6	Trailer Brake Controller
7	Front Washer
8	Oxygen Sensor
9	Antilock Brakes System 2
10	Trailer Back-up Lamps
11	Driver Side Low-Beam Headlamp
12	Engine Control Module (Battery)
13	Fuel Injectors, Ignition Coils (Right Side)

<b>Fuses</b>	<b>Usage</b>
14	Transmission Control Module (Battery)
15	Vehicle Back-up Lamps
16	Passenger Side Low-Beam Headlamp
17	Air Conditioning Compressor
18	Oxygen Sensors
19	Transmission Controls (Ignition)
20	Fuel Pump
21	Fuel System Control Module
22	Not Used
23	Not Used
24	Fuel Injectors, Ignition Coils (Left Side)

<b>Fuses</b>	<b>Usage</b>
25	Trailer Park Lamps
26	Driver Side Park Lamps
27	Passenger Side Park Lamps
28	Fog Lamps
29	Horn
30	Passenger Side High-Beam Headlamp
31	Daytime Running Lamps (DRL)
32	Driver Side High-Beam Headlamp
33	Daytime Running Lamps 2
34	Sunroof
35	Key Ignition System, Theft Deterrent System

## 10-42 Vehicle Care

Fuses	Usage
36	Windshield Wiper
37	SEO B2 Upfitter Usage (Battery)
38	Electric Adjustable Pedals
39	Climate Controls (Battery)
40	Airbag System (Ignition)
41	Amplifier
42	Audio System
43	Miscellaneous (Ignition), Cruise Control
44	Not Used
45	Airbag System (Battery)
46	Instrument Panel Cluster
47	Power Take-Off

Fuses	Usage
48	Auxiliary Climate Control (Ignition)
49	Center High-Mounted Stoplamp (CHMSL)
50	Rear Defogger
51	Heated Mirrors
52	SEO B1 Upfitter Usage (Battery)
53	Accessory Power Outlet
54	SEO Upfitter Usage
55	Climate Controls (Ignition)
56	Engine Control Module, Secondary Fuel Pump (Ignition)

J-Case Fuses	Usage
57	Cooling Fan 1
58	Not Used
59	Heavy Duty Antilock Brake System
60	Cooling Fan 2
61	Antilock Brake System 1
62	Starter
63	Stud 2 (Trailer Brakes)
64	Left Bussed Electrical Center 1
65	Not Used
66	Not Used
67	Transfer Case

J-Case Fuses	Usage
68	Stud 1 (Trailer Connector Battery Power) (Optional - 40A Fuse Required)
69	Mid-Bussed Electrical Center 1
70	Climate Control Blower
71	Not Used
72	Left Bussed Electrical Center 2

Relays	Usage
FAN HI	Cooling Fan High Speed
FAN LO	Cooling Fan Low Speed
FAN CNTRL	Cooling Fan Control

Relays	Usage
HDLP LO/HID	Low-Beam Headlamp
FOG LAMP	Front Fog Lamps
A/C CMPSR	Air Conditioning Compressor
STRTR	Starter
PWR/TRN	Powertrain
FUEL PMP	Fuel Pump
PRK LAMP	Parking Lamps
REAR DEFOG	Rear Defogger
RUN/CRNK	Switched Power

### Instrument Panel Fuse Block

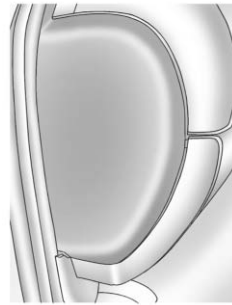

The instrument panel fuse block access door is located on the driver side edge of the instrument panel. Pull off the cover to access the fuse block.

## 10-44 Vehicle Care

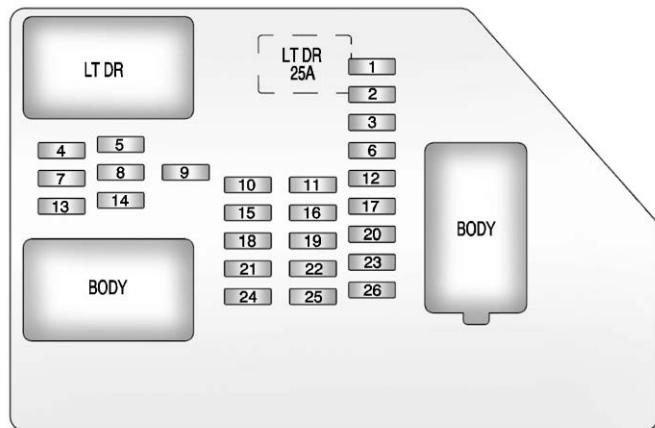

The vehicle may not be equipped with all of the fuses, relays, and features shown.

Fuses	Usage
1	Rear Seats
2	Rear Accessory Power Outlet

Fuses	Usage
3	Steering Wheel Controls Backlight
4	Driver Door Module
5	Dome Lamps, Driver Side Turn Signal

Fuses	Usage
6	Driver Side Turn Signal, Stoplamp
7	Instrument Panel Back Lighting
8	Passenger Side Turn Signal, Stoplamp
9	Passenger Door Module, Driver Unlock
10	Power Door Lock 2 (Unlock Feature)
11	Power Door Lock 2 (Lock Feature)
12	Stoplamps, Center High-Mounted Stoplamp
13	Rear Climate Controls
14	Power Mirror
15	Body Control Module (BCM)
16	Accessory Power Outlets

Fuses	Usage
17	Interior Lamps
18	Power Door Lock 1 (Unlock Feature)
19	Rear Seat Entertainment
20	Ultrasonic Rear Parking Assist, Power Liftgate
21	Power Door Lock 1 (Lock Feature)
22	Driver Information Center (DIC)
23	Rear Wiper
24	Cooled Seats
25	Driver Seat Module, Remote Keyless Entry System
26	Driver Power Door Lock (Unlock Feature)

Circuit Breaker	Usage
LT DR	Driver Side Power Window Circuit Breaker

Harness Connector	Usage
LT DR	Driver Door Harness Connection
BODY	Harness Connector
BODY	Harness Connector

### Center Instrument Panel Fuse Block

The center instrument panel fuse block is located underneath the instrument panel, to the left of the steering column.

### Top View

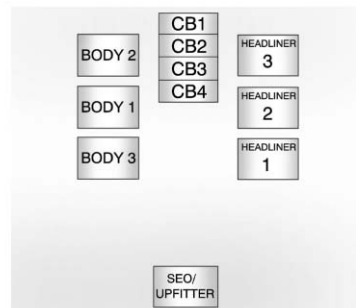

Harness Connector	Usage
BODY 2	Body Harness Connector 2
BODY 1	Body Harness Connector 1
BODY 3	Body Harness Connector 3
HEADLINER 3	Headliner Harness Connector 3

Harness Connector	Usage
HEADLINER 2	Headliner Harness Connector 2
HEADLINER 1	Headliner Harness Connector 1
SEO/ UPFITTER	Special Equipment Option Upfitter Harness Connector

Circuit Breaker	Usage
CB1	Passenger Side Power Window Circuit Breaker
CB2	Passenger Seat Circuit Breaker
CB3	Driver Seat Circuit Breaker
CB4	Rear Sliding Window

## Wheels and Tires

### Tires

Every new GM vehicle has high-quality tires made by a leading tire manufacturer. See the warranty manual for information regarding the tire warranty and where to get service. For additional information refer to the tire manufacturer.

#### WARNING

- Poorly maintained and improperly used tires are dangerous.
- Overloading the tires can cause overheating as a result of too much flexing. There could be a blowout

(Continued)

#### WARNING (Continued)

and a serious crash. See *Vehicle Load Limits on page 9-15*.

- Underinflated tires pose the same danger as overloaded tires. The resulting crash could cause serious injury. Check all tires frequently to maintain the recommended pressure. Tire pressure should be checked when the tires are cold.
- Overinflated tires are more likely to be cut, punctured, or broken by a sudden impact— such as when hitting a pothole. Keep tires at the recommended pressure.

(Continued)



**WARNING (Continued)**

- Worn or old tires can cause a crash. If the tread is badly worn, replace them.
- Replace any tires that have been damaged by impacts with potholes, curbs, etc.
- Improperly repaired tires can cause a crash. Only the dealer or an authorized tire service center should repair, replace, dismount, and mount the tires.
- Do not spin the tires in excess of 56 km/h (35 mph) on slippery surfaces such as snow, mud, ice, etc. Excessive spinning may cause the tires to explode.

See *Tire Pressure for High-Speed Operation on page 10-56* for inflation pressure adjustment for high speed driving.

**20-Inch Tires**

If the vehicle has 20-inch P275/55R20 size tires, they are classified as touring tires and are designed for on road use. The low-profile, wide tread design is not recommended for “off-road” driving or commercial uses such as snow plowing. See *Off-Road Driving on page 9-5* and *Adding a Snow Plow or Similar Equipment on page 9-101* for additional information.

**Notice: Low-profile tires are more susceptible to damage from road hazards or curb impact than standard profile tires. Tire and/or wheel assembly damage can occur**

**when coming into contact with road hazards like, potholes, or sharp edged objects, or when sliding into a curb. The warranty does not cover this type of damage. Keep tires set to the correct inflation pressure and, when possible, avoid contact with curbs, potholes, and other road hazards.**

**All-Season Tires**

This vehicle may come with all-season tires. These tires are designed to provide good overall performance on most road surfaces and weather conditions. Original equipment tires designed to GM's specific tire performance criteria have a TPC specification code molded onto the sidewall. Original equipment all-season tires can be identified by the last two characters of this TPC code, which will be “MS.”

Consider installing winter tires on the vehicle if frequent driving on snow or ice-covered roads is expected. All-season tires provide adequate performance for most winter driving conditions, but they may not offer the same level of traction or performance as winter tires on snow or ice-covered roads. See *Winter Tires on page 10-48*.

### Winter Tires

This vehicle was not, originally, equipped with winter tires. Winter tires are designed for increased traction on snow and ice-covered roads. Consider installing winter tires on the vehicle if frequent driving on snow or ice-covered roads is expected. See your dealer for details regarding winter tire availability and proper tire selection. Also, see *Buying New Tires on page 10-65*.

With winter tires, there may be decreased dry road traction, increased road noise, and shorter tread life. After changing to winter tires, be alert for changes in vehicle handling and braking.

If using winter tires:

- Use tires of the same brand and tread type on all four wheel positions.
- Use only radial ply tires of the same size, load range, and speed rating as the original equipment tires.

Winter tires with the same speed rating as the original equipment tires may not be available for H, V, W, Y, and ZR speed rated tires. If winter tires with a lower speed rating are chosen, never exceed the tire's maximum speed capability.

### Summer Tires

This vehicle may come with high performance summer tires. These tires have a special tread and compound that are optimized for maximum dry and wet road performance. This special tread and compound will decrease performance in cold climates, and on ice and snow. We recommend installing winter tires on the vehicle if frequent driving in cold temperatures or on snow or ice covered roads is expected. See *Winter Tires on page 10-48*.

### Tire Sidewall Labeling

Useful information about a tire is molded into the sidewall. The examples show a typical passenger and light truck tire sidewall.

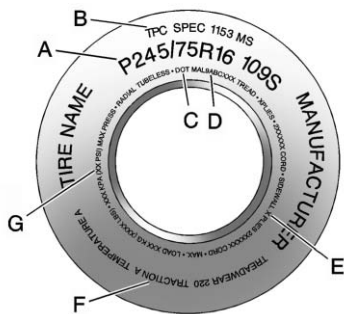

### Passenger (P-Metric) Tire

**(A) Tire Size:** The tire size code is a combination of letters and numbers used to define a particular tire's width, height, aspect ratio, construction type, and service description. See the "Tire Size" illustration later in this section for more detail.

**(B) TPC Spec (Tire Performance Criteria Specification):** Original equipment tires designed to GM's specific tire performance

criteria have a TPC specification code molded onto the sidewall. GM's TPC specifications meet or exceed all federal safety guidelines.

**(C) DOT (Department of Transportation):** The Department of Transportation (DOT) code indicates that the tire is in compliance with the U.S. Department of Transportation Motor Vehicle Safety Standards.

**DOT Tire Date of Manufacture:** The last four digits of the TIN indicate the tire manufactured date. The first two digits represent the week (01-52) and the last two digits, the year. For example, the third week of the year 2010 would have a four-digit DOT date of 0310.

**(D) Tire Identification Number (TIN):** The letters and numbers following the DOT code are the Tire Identification Number (TIN). The TIN shows the manufacturer and plant code, tire size, and date the tire was manufactured. The TIN is molded onto both sides of the tire, although only one side may have the date of manufacture.

**(E) Tire Ply Material:** The type of cord and number of plies in the sidewall and under the tread.

**(F) Uniform Tire Quality Grading (UTQG):** Tire manufacturers are required to grade tires based on three performance factors: treadwear, traction, and temperature resistance. For more information, see *Uniform Tire Quality Grading* on page 10-67.

**(G) Maximum Cold Inflation Load Limit:** Maximum load that can be carried and the maximum pressure needed to support that load. For information on recommended tire pressure see *Tire Pressure on page 10-55* and *Vehicle Load Limits on page 9-15*.

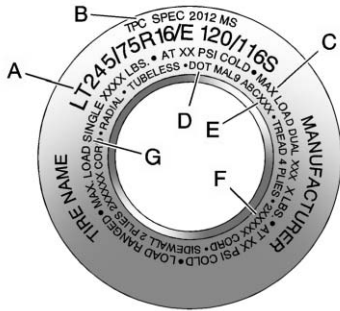

**Light Truck (LT-Metric) Tire**

**(A) Tire Size:** The tire size code is a combination of letters and numbers used to define a particular tire's width, height,

aspect ratio, construction type, and service description. See the "Tire Size" illustration later in this section for more detail.

**(B) TPC Spec (Tire Performance Criteria Specification):** Original equipment tires designed to GM's specific tire performance criteria have a TPC specification code molded onto the sidewall. GM's TPC specifications meet or exceed all federal safety guidelines.

**(C) Dual Tire Maximum Load:** Maximum load that can be carried and the maximum pressure needed to support that load when used in a dual configuration. For information on recommended tire pressure see *Tire Pressure on page 10-55* and *Vehicle Load Limits on page 9-15*.

**(D) DOT (Department of Transportation):** The Department of Transportation (DOT) code indicates that the tire is in compliance with the U.S. Department of Transportation Motor Vehicle Safety Standards.

**DOT Tire Date of Manufacture:** The last four digits of the TIN indicate the tire manufactured date. The first two digits represent the week (01-52) and the last two digits, the year. For example, the third week of the year 2010 would have a four-digit DOT date of 0310.

**(E) Tire Identification Number (TIN):** The letters and numbers following the DOT code are the Tire Identification Number (TIN). The TIN shows the manufacturer and plant code, tire size, and date the tire was

manufactured. The TIN is molded onto both sides of the tire, although only one side may have the date of manufacture.

**(F) Tire Ply Material:** The type of cord and number of plies in the sidewall and under the tread.

**(G) Single Tire Maximum Load:** Maximum load that can be carried and the maximum pressure needed to support that load when used as a single. For information on recommended tire pressure see *Tire Pressure* on page 10-55 and *Vehicle Load Limits* on page 9-15.

## Tire Designations

### Tire Size

The examples show a typical passenger vehicle and light truck tire size.



### Passenger (P-Metric) Tire

- (A) Passenger (P-Metric) Tire:** The United States version of a metric tire sizing system. The letter P as the first character in the tire size means a passenger vehicle tire engineered to standards set by the U.S. Tire and Rim Association.
- (B) Tire Width:** The three-digit number indicates the tire section width in millimeters from sidewall to sidewall.
- (C) Aspect Ratio:** A two-digit number that indicates the tire height-to-width measurements. For example, if the tire size aspect ratio is 75, as shown in item C of the tire illustration, it

would mean that the tire's sidewall is 75 percent as high as it is wide.

**(D) Construction Code:** A letter code is used to indicate the type of ply construction in the tire. The letter R means radial ply construction; the letter D means diagonal or bias ply construction; and the letter B means belted-bias ply construction.

**(E) Rim Diameter:** Diameter of the wheel in inches.

**(F) Service Description:** These characters represent the load index and speed rating of the tire. The load index represents the load carrying capacity a tire is certified to carry. The speed rating is the maximum speed a tire is certified to carry a load.



### Light Truck (LT-Metric) Tire

#### (A) Light Truck (LT-Metric)

**Tire:** The United States version of a metric tire sizing system. The letters LT as the first two characters in the tire size mean a light truck tire engineered to standards set by the U.S. Tire and Rim Association.

**(B) Tire Width:** The three-digit number indicates the tire section width in millimeters from sidewall to sidewall.

**(C) Aspect Ratio:** A two-digit number that indicates the tire height-to-width measurements. For example, if the tire size aspect ratio is 75, as shown in item C of the light truck

(LT-Metric) tire illustration, it would mean that the tire's sidewall is 75 percent as high as it is wide.

#### (D) Construction Code:

A letter code is used to indicate the type of ply construction in the tire. The letter R means radial ply construction; the letter D means diagonal or bias ply construction; and the letter B means belted-bias ply construction.

**(E) Rim Diameter:** Diameter of the wheel in inches.

**(F) Load Range:** Load Range.

**(G) Service Description:** The service description indicates the load index and speed rating of a tire. If two numbers are given as in the example, 120/116, then this represents the load index for single versus dual wheel usage

(single/dual). The speed rating is the maximum speed a tire is certified to carry a load.

### Tire Terminology and Definitions

**Air Pressure:** The amount of air inside the tire pressing outward on each square inch of the tire. Air pressure is expressed in kPa (kilopascal) or psi (pounds per square inch).

**Accessory Weight:** The combined weight of optional accessories. Some examples of optional accessories are automatic transmission, power steering, power brakes, power windows, power seats, and air conditioning.

**Aspect Ratio:** The relationship of a tire's height to its width.

**Belt:** A rubber coated layer of cords between the plies and the tread. Cords may be made from steel or other reinforcing materials.

**Bead:** The tire bead contains steel wires wrapped by steel cords that hold the tire onto the rim.

**Bias Ply Tire:** A pneumatic tire in which the plies are laid at alternate angles less than 90 degrees to the centerline of the tread.

**Cold Tire Pressure:** The amount of air pressure in a tire, measured in kPa (kilopascal) or psi (pounds per square inch) before a tire has built up heat from driving. See *Tire Pressure on page 10-55*.

**Curb Weight:** The weight of a motor vehicle with standard and optional equipment including the

maximum capacity of fuel, oil, and coolant, but without passengers and cargo.

**DOT Markings:** A code molded into the sidewall of a tire signifying that the tire is in compliance with the U.S. Department of Transportation (DOT) Motor Vehicle Safety Standards. The DOT code includes the Tire Identification Number (TIN), an alphanumeric designator which can also identify the tire manufacturer, production plant, brand, and date of production.

**GVWR:** Gross Vehicle Weight Rating. See *Vehicle Load Limits on page 9-15*.

**GAWR FRT:** Gross Axle Weight Rating for the front axle. See *Vehicle Load Limits on page 9-15*.

**GAWR RR:** Gross Axle Weight Rating for the rear axle. See *Vehicle Load Limits on page 9-15*.

**Intended Outboard Sidewall:** The side of an asymmetrical tire, that must always face outward when mounted on a vehicle.

**Kilopascal (kPa):** The metric unit for air pressure.

**Light Truck (LT-Metric) Tire:** A tire used on light duty trucks and some multipurpose passenger vehicles.

**Load Index:** An assigned number ranging from 1 to 279 that corresponds to the load carrying capacity of a tire.

**Maximum Inflation Pressure:** The maximum air pressure to which a cold tire can be inflated. The maximum air pressure is molded onto the sidewall.

**Maximum Load Rating:** The load rating for a tire at the maximum permissible inflation pressure for that tire.

**Maximum Loaded Vehicle Weight:** The sum of curb weight, accessory weight, vehicle capacity weight, and production options weight.

**Normal Occupant Weight:** The number of occupants a vehicle is designed to seat multiplied by 68 kg (150 lbs). See *Vehicle Load Limits* on page 9-15.

**Occupant Distribution:** Designated seating positions.

**Outward Facing Sidewall:** The side of an asymmetrical tire that has a particular side that faces outward when mounted on a vehicle. The side of the tire that contains a whitewall, bears white lettering, or bears manufacturer, brand, and/or

model name molding that is higher or deeper than the same moldings on the other sidewall of the tire.

**Passenger (P-Metric) Tire:** A tire used on passenger cars and some light duty trucks and multipurpose vehicles.

**Recommended Inflation Pressure:** Vehicle manufacturer's recommended tire inflation pressure as shown on the tire placard. See *Tire Pressure* on page 10-55 and *Vehicle Load Limits* on page 9-15.

**Radial Ply Tire:** A pneumatic tire in which the ply cords that extend to the beads are laid at 90 degrees to the centerline of the tread.

**Rim:** A metal support for a tire and upon which the tire beads are seated.

**Sidewall:** The portion of a tire between the tread and the bead.

**Speed Rating:** An alphanumeric code assigned to a tire indicating the maximum speed at which a tire can operate.

**Traction:** The friction between the tire and the road surface. The amount of grip provided.

**Tread:** The portion of a tire that comes into contact with the road.

**Treadwear Indicators:** Narrow bands, sometimes called wear bars, that show across the tread of a tire when only 1.6 mm (1/16 in) of tread remains. See *When It Is Time for New Tires* on page 10-64.

**UTQGS (Uniform Tire Quality Grading Standards):** A tire information system that provides consumers with ratings for a



tire's traction, temperature, and treadwear. Ratings are determined by tire manufacturers using government testing procedures. The ratings are molded into the sidewall of the tire. See *Uniform Tire Quality Grading* on page 10-67.

**Vehicle Capacity Weight:** The number of designated seating positions multiplied by 68 kg (150 lbs) plus the rated cargo load. See *Vehicle Load Limits* on page 9-15.

**Vehicle Maximum Load on the Tire:** Load on an individual tire due to curb weight, accessory weight, occupant weight, and cargo weight.

**Vehicle Placard:** A label permanently attached to a vehicle showing the vehicle capacity weight and the original equipment tire size and

recommended inflation pressure. See "Tire and Loading Information Label" under *Vehicle Load Limits* on page 9-15.

## Tire Pressure

Tires need the correct amount of air pressure to operate effectively.

**Notice: Neither tire underinflation nor overinflation is good. Underinflated tires, or tires that do not have enough air, can result in:**

- **Tire overloading and overheating which could lead to a blowout.**
- **Premature or irregular wear.**
- **Poor handling.**
- **Reduced fuel economy.**

**Overinflated tires, or tires that have too much air, can result in:**

- **Unusual wear.**
- **Poor handling.**
- **Rough ride.**
- **Needless damage from road hazards.**

The Tire and Loading Information label on the vehicle indicates the original equipment tires and the correct cold tire inflation pressures. The recommended pressure is the minimum air pressure needed to support the vehicle's maximum load carrying capacity.

For additional information regarding how much weight the vehicle can carry, and an example of the Tire and Loading Information label, see *Vehicle Load Limits* on page 9-15. How the vehicle is loaded affects

vehicle handling and ride comfort. Never load the vehicle with more weight than it was designed to carry.

### When to Check

Check the tires once a month or more.

Do not forget the spare tire, if the vehicle has one. See *Full-Size Spare Tire on page 10-82* for additional information.

### How to Check

Use a good quality pocket-type gauge to check tire pressure. Proper tire inflation cannot be determined by looking at the tire. Check the tire inflation pressure when the tires are cold, meaning the vehicle has not been driven for at least three hours or no more than 1.6 km (1 mi).

Remove the valve cap from the tire valve stem. Press the tire gauge firmly onto the valve to get a pressure measurement. If the cold tire inflation pressure matches the recommended pressure on the Tire and Loading Information label, no further adjustment is necessary. If the inflation pressure is low, add air until the recommended pressure is reached. If the inflation pressure is high, press on the metal stem in the center of the tire valve to release air.

Re-check the tire pressure with the tire gauge.

Return the valve caps on the valve stems to prevent leaks and keep out dirt and moisture.

## Tire Pressure for High-Speed Operation

### WARNING

Driving at high speeds, 160 km/h (100 mph) or higher, puts an additional strain on tires. Sustained high-speed driving causes excessive heat buildup and can cause sudden tire failure. You could have a crash and you or others could be killed. Some high-speed rated tires require inflation pressure adjustment for high-speed operation. When speed limits and road conditions are such that a vehicle can be driven at high speeds, make sure the tires are rated for high-speed operation, in excellent condition, and set to the correct cold tire inflation pressure for the vehicle load.

Vehicles with P265/70R17 or P275/55R20 size tires require inflation pressure adjustment when driving the vehicle at speeds of 160 km/h (100 mph) or higher. Set the cold tire inflation pressure to 20 kPa (3 psi) above the recommended cold tire pressure shown on the Tire and Loading Information label.

Return the tires to the recommended cold tire inflation pressure when high-speed driving has ended. See *Vehicle Load Limits* on page 9-15 and *Tire Pressure* on page 10-55.

## Tire Pressure Monitor System

The Tire Pressure Monitor System (TPMS) uses radio and sensor technology to check tire pressure levels. The TPMS sensors monitor the air pressure in your tires and transmit tire pressure readings to a receiver located in the vehicle.

Each tire, including the spare (if provided), should be checked monthly when cold and inflated to the inflation pressure recommended by the vehicle manufacturer on the vehicle placard or tire inflation pressure label. (If your vehicle has tires of a different size than the size indicated on the vehicle placard or tire inflation pressure label, you should determine the proper tire inflation pressure for those tires.)

As an added safety feature, your vehicle has been equipped with a tire pressure monitoring system (TPMS) that illuminates a low tire pressure telltale when one or more of your tires is significantly under-inflated.

Accordingly, when the low tire pressure telltale illuminates, you should stop and check your tires as soon as possible, and inflate them to the proper pressure. Driving on a significantly under-inflated tire causes the tire to overheat and can lead to tire failure. Under-inflation also reduces fuel efficiency and tire

tread life, and may affect the vehicle's handling and stopping ability.

Please note that the TPMS is not a substitute for proper tire maintenance, and it is the driver's responsibility to maintain correct tire pressure, even if under-inflation has not reached the level to trigger illumination of the TPMS low tire pressure telltale.

Your vehicle has also been equipped with a TPMS malfunction indicator to indicate when the system is not operating properly. The TPMS malfunction indicator is combined with the low tire pressure telltale. When the system detects a malfunction, the telltale will flash for approximately one minute and then remain continuously illuminated. This sequence will continue upon subsequent vehicle start-ups as long as the malfunction exists.

When the malfunction indicator is illuminated, the system may not be able to detect or signal low tire

pressure as intended. TPMS malfunctions may occur for a variety of reasons, including the installation of replacement or alternate tires or wheels on the vehicle that prevent the TPMS from functioning properly. Always check the TPMS malfunction telltale after replacing one or more tires or wheels on your vehicle to ensure that the replacement or alternate tires and wheels allow the TPMS to continue to function properly.

See *Tire Pressure Monitor Operation* on page 10-58.

### **Federal Communications Commission (FCC) Rules and with Industry Canada Standards**

See *Radio Frequency Statement* on page 13-20 for information regarding Part 15 of the Federal Communications Commission (FCC) Rules and with Industry Canada Standards RSS-GEN/210/220/310.

### **Tire Pressure Monitor Operation**

This vehicle may have a Tire Pressure Monitor System (TPMS). The TPMS is designed to warn the driver when a low tire pressure condition exists. TPMS sensors are mounted onto each tire and wheel assembly, excluding the spare tire and wheel assembly. The TPMS sensors monitor the air pressure in the tires and transmit the tire pressure readings to a receiver located in the vehicle.



When a low tire pressure condition is detected, the TPMS illuminates the low tire pressure warning light located on the instrument cluster. If the warning light comes on, stop as soon as possible and inflate the

tires to the recommended pressure shown on the Tire and Loading Information label. See *Vehicle Load Limits* on page 9-15.

A message to check the pressure in a specific tire displays in the Driver Information Center (DIC). The low tire pressure warning light and the DIC warning message come on at each ignition cycle until the tires are inflated to the correct inflation pressure. If the vehicle has DIC buttons, tire pressure levels can be viewed. For additional information and details about the DIC operation and displays, see *Driver Information Center (DIC)* on page 5-28 and *Tire Messages* on page 5-43.

The low tire pressure warning light may come on in cool weather when the vehicle is first started, and then turn off as the vehicle is driven. This could be an early indicator that the air pressure is getting low and needs to be inflated to the proper pressure.

A Tire and Loading Information label shows the size of the original equipment tires and the correct inflation pressure for the tires when they are cold. See *Vehicle Load Limits* on page 9-15, for an example of the Tire and Loading Information label and its location. Also see *Tire Pressure* on page 10-55.

The TPMS can warn about a low tire pressure condition but it does not replace normal tire maintenance. See *Tire Inspection* on page 10-61, *Tire Rotation* on page 10-61 and *Tires* on page 10-46.

**Notice:** Tire sealant materials are not all the same. A non-approved tire sealant could damage the TPMS sensors. TPMS sensor damage caused by using an incorrect tire sealant is not covered by the vehicle warranty. Always use only the GM-approved tire sealant available through your dealer or included in the vehicle.

### TPMS Malfunction Light and Message

The TPMS will not function properly if one or more of the TPMS sensors are missing or inoperable. When the system detects a malfunction, the low tire pressure warning light flashes for about one minute and then stays on for the remainder of the ignition cycle. A DIC warning message also displays. The malfunction light and DIC warning message come on at each ignition cycle until the problem is corrected. Some of the conditions that can cause these to come on are:

- One of the road tires has been replaced with the spare tire. The spare tire does not have a TPMS sensor. The malfunction light and the DIC message should go off after the road tire is replaced and the sensor matching process is performed successfully. See "TPMS Sensor Matching Process" later in this section.
- The TPMS sensor matching process was not done or not completed successfully after rotating the tires. The malfunction light and the DIC message should go off after successfully completing the sensor matching process. See "TPMS Sensor Matching Process" later in this section.
- One or more TPMS sensors are missing or damaged. The malfunction light and the DIC message should go off when the TPMS sensors are installed and the sensor matching process is performed successfully. See your dealer for service.
- Replacement tires or wheels do not match the original equipment tires or wheels. Tires and wheels other than those recommended could prevent the TPMS from functioning properly. See *Buying New Tires* on page 10-65.

## 10-60 Vehicle Care

---

- Operating electronic devices or being near facilities using radio wave frequencies similar to the TPMS could cause the TPMS sensors to malfunction.

If the TPMS is not functioning properly, it cannot detect or signal a low tire condition. See your dealer for service if the TPMS malfunction light and DIC message come on and stay on.



### TPMS Sensor Matching Process

Each TPMS sensor has a unique identification code. The identification code needs to be matched to a new tire/wheel position after rotating the vehicle's tires or replacing one or more of the TPMS sensors. Also, the TPMS sensor matching process should be performed after replacing a spare tire with a road tire containing the TPMS sensor. The malfunction light and the DIC message should go off at the next ignition cycle. The sensors are matched to the tire/wheel positions,

using a TPMS relearn tool, in the following order: driver side front tire, passenger side front tire, passenger side rear tire, and driver side rear. See your dealer for service or to purchase a relearn tool.

There are two minutes to match the first tire/wheel position, and five minutes overall to match all four tire/wheel positions. If it takes longer, the matching process stops and must be restarted.

The TPMS sensor matching process is:

- Set the parking brake.
- Turn the ignition to ON/RUN with the engine off.
- Press the Remote Keyless Entry (RKE) transmitter's  and  buttons at the same time for approximately five seconds. The horn sounds twice to signal the

receiver is in relearn mode and the TIRE LEARNING ACTIVE message displays on the DIC screen.

If the vehicle does not have RKE, press the Driver Information Center (DIC) vehicle information button until the **PRESS ✓ TO RELEARN TIRE POSITIONS** message displays. The horn sounds twice to signal the receiver is in relearn mode and TIRE LEARNING ACTIVE message displays on the DIC screen.

If the vehicle does not have RKE or DIC buttons, press the trip odometer reset stem on the instrument cluster until the **PRESS ✓ TO RELEARN TIRE POSITIONS** message displays. The horn sounds twice to signal the receiver is in relearn mode and TIRE LEARNING ACTIVE message displays on the DIC screen.

4. Start with the driver side front tire.
5. Place the relearn tool against the tire sidewall, near the valve stem. Then press the button to activate the TPMS sensor. A horn chirp confirms that the sensor identification code has been matched to this tire and wheel position.
6. Proceed to the passenger side front tire, and repeat the procedure in Step 5.
7. Proceed to the passenger side rear tire, and repeat the procedure in Step 5.
8. Proceed to the driver side rear tire, and repeat the procedure in Step 5. The horn sounds two times to indicate the sensor identification code has been matched to the driver side rear tire, and the TPMS sensor matching process is no longer active. The TIRE LEARNING ACTIVE message on the DIC display screen goes off.

9. Turn the ignition switch to LOCK/OFF.
10. Set all four tires to the recommended air pressure level as indicated on the Tire and Loading Information label.

### Tire Inspection

We recommend that the tires, including the spare tire, if the vehicle has one, be inspected for signs of wear or damage at least once a month.

Replace the tire if:

- The indicators at three or more places around the tire can be seen.
- There is cord or fabric showing through the tire's rubber.
- The tread or sidewall is cracked, cut, or snagged deep enough to show cord or fabric.

- The tire has a bump, bulge, or split.
- The tire has a puncture, cut, or other damage that cannot be repaired well because of the size or location of the damage.

### Tire Rotation

Tires should be rotated every 12 000 km (7,500 mi). See *Maintenance Schedule on page 11-3*.

Tires are rotated to achieve a uniform wear for all tires. The first rotation is the most important.

Anytime unusual wear is noticed, rotate the tires as soon as possible, check for proper tire inflation pressure, and check for damaged tires or wheels. If the unusual wear continues after the

## 10-62 Vehicle Care

rotation, check the wheel alignment. See *When It Is Time for New Tires on page 10-64* and *Wheel Replacement on page 10-69*.

If your vehicle has dual rear wheels, also see *Dual Tire Rotation on page 10-63*.

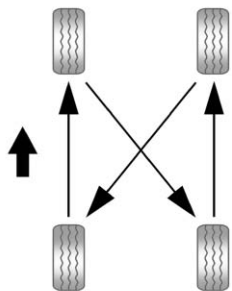

Use this rotation pattern when rotating the tires if the vehicle has single rear wheels.

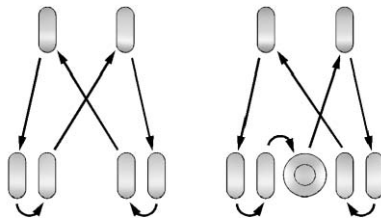

Use this rotation pattern when rotating the tires if the vehicle has dual rear wheels (except polished forged aluminum wheels).

Vehicles with polished forged aluminum dual wheels have three unique wheels; a front, a rear outer and a rear inner. These wheels cannot be rotated to another position, however, they can be rotated from left to right to the same position.

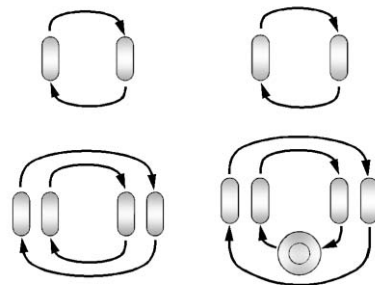

Use this rotation pattern when rotating the tires if the vehicle has polished forged aluminum dual rear wheels. The spare wheel can be used in any position and can be rotated with the rear inner wheels.

When installing dual wheels, check that the vent holes in the inner and outer wheels on each side are lined up.

Adjust the front and rear tires to the recommended inflation pressure on the Tire and



Loading Information label after the tires have been rotated. See *Tire Pressure on page 10-55* and *Vehicle Load Limits on page 9-15*.

Check that all wheel nuts are properly tightened. See “Wheel Nut Torque” under *Capacities and Specifications on page 12-2*.

 **WARNING**

Rust or dirt on a wheel, or on the parts to which it is fastened, can make wheel nuts become loose after time. The wheel could come off and cause an accident. When changing a wheel, remove any rust or dirt from places where the wheel attaches to the vehicle. In an emergency, a cloth or a paper towel can be used; however, use a scraper or wire brush later to remove all rust or dirt.

Lightly coat the center of the wheel hub with wheel bearing grease after a wheel change or tire rotation to prevent corrosion or rust build-up. Do not get grease on the flat wheel mounting surface or on the wheel nuts or bolts.

Reset the Tire Pressure Monitor System (TPMS), if the vehicle has one. See *Tire Pressure Monitor Operation on page 10-58*.

Check that the spare tire, if the vehicle has one, is stored properly. Push, pull, and then try to rotate or turn the tire. If it moves, tighten the cable. See “Storing a Flat or Spare Tire and Tools” under *Tire Changing on page 10-72*.

## Dual Tire Rotation

When the vehicle is new, or whenever a wheel, wheel bolt, or wheel nut is replaced, check the wheel nut torque after 160, 1 600, and 10 000 km (100, 1,000, and 6,000 mi) of driving. For proper torque and wheel nut tightening information, see “Removing the Flat Tire and Installing the Spare Tire” under *Tire Changing on page 10-72*.

The outer tire on a dual wheel setup generally wears faster than the inner tire. Tires last longer and wear more evenly if they are rotated. See *Tire Inspection on page 10-61* and *Tire Rotation on page 10-61*. Also see *Maintenance Schedule on page 11-3*.

### **WARNING**

If the vehicle is operated with a tire that is underinflated, the tire can overheat. An overheated tire can lose air suddenly or catch fire. You or others could be injured. Properly inflate all tires, including the spare.

See *Tire Pressure* on page 10-55, for information on proper tire inflation.

### **When It Is Time for New Tires**

Factors, such as maintenance, temperatures, driving speeds, vehicle loading, and road conditions affect the wear rate of the tires.

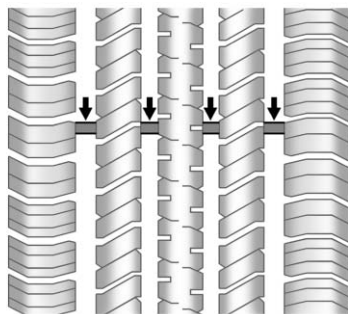

Treadwear indicators are one way to tell when it is time for new tires. Treadwear indicators appear when the tires have only 1.6 mm (1/16 in) or less of tread remaining. Some commercial truck tires may not have treadwear indicators. See *Tire Inspection* on page 10-61 and *Tire Rotation* on page 10-61 for additional information.

The rubber in tires ages over time. This also applies to the spare tire, if the vehicle has one, even if it is never used. Multiple factors including temperatures, loading conditions, and inflation pressure

maintenance affect how fast aging takes place. GM recommends that tires, including the spare if equipped, be replaced after six years, regardless of tread wear. The tire manufacturer date is the last four digits of the DOT Tire Identification Number (TIN) which is molded into one side of the tire sidewall. The first two digits represent the week (01-52) and the last two digits, the year. For example, the third week of the year 2010 would have a four-digit DOT date of 0310.

### **Vehicle Storage**

Tires age when stored normally mounted on a parked vehicle. Park a vehicle that will be stored for at least a month in a cool, dry, clean area away from direct sunlight to slow aging. This area should be free of grease, gasoline or other substances that can deteriorate rubber.

Parking for an extended period can cause flat spots on the tires that may result in vibrations while driving. When storing a vehicle for at least a month, remove the tires or raise the vehicle to reduce the weight from the tires.

## Buying New Tires

GM has developed and matched specific tires for the vehicle. The original equipment tires installed were designed to meet General Motors Tire Performance Criteria Specification (TPC Spec) system rating. When replacement tires are needed, GM strongly recommends buying tires with the same TPC Spec rating.

GM's exclusive TPC Spec system considers over a dozen critical specifications that impact the overall performance of the

vehicle, including brake system performance, ride and handling, traction control, and tire pressure monitoring performance. GM's TPC Spec number is molded onto the tire's sidewall near the tire size. If the tires have an all-season tread design, the TPC Spec number will be followed by MS for mud and snow. See *Tire Sidewall Labeling on page 10-48* for additional information.

GM recommends replacing worn tires in complete sets of four (six for dual rear wheels). Uniform tread depth on all tires will help to maintain the performance of the vehicle. Braking and handling performance may be adversely affected if all the tires are not replaced at the same time. If proper rotation and maintenance have been done,

all four tires (six for dual rear wheels) should wear out at about the same time. See *Tire Rotation on page 10-61* for information on proper tire rotation. However, if it is necessary to replace only one axle set of worn tires, place the new tires on the rear axle (two for single rear wheels, four for dual rear wheels).

### WARNING

Tires could explode during improper service. Attempting to mount or dismount a tire could cause injury or death. Only your dealer or authorized tire service center should mount or dismount the tires.

 **WARNING**

Mixing tires of different sizes, brands, or types may cause loss of control of the vehicle, resulting in a crash or other vehicle damage. Use the correct size, brand, and type of tires on all wheels.

This vehicle may have a different size spare than the road tires originally installed on the vehicle. When new, the vehicle included a spare tire and wheel assembly with a similar overall diameter as the road tires and wheels, so it is all right to drive on it. The spare tire was developed for use on this vehicle and will not affect vehicle handling.

 **WARNING**

Using bias-ply tires on the vehicle may cause the wheel rim flanges to develop cracks after many miles of driving. A tire and/or wheel could fail suddenly and cause a crash. Use only radial-ply tires with the wheels on the vehicle.

If the vehicle tires must be replaced with a tire that does not have a TPC Spec number, make sure they are the same size, load range, speed rating, and construction (radial) as the original tires.

Vehicles that have a tire pressure monitoring system could give an inaccurate low-pressure warning if non-TPC Spec rated tires are installed. See *Tire Pressure Monitor System on page 10-57*.

The Tire and Loading Information label indicates the original equipment tires on the vehicle. See *Vehicle Load Limits on page 9-15* for the label location and more information about the Tire and Loading Information label.

### **Different Size Tires and Wheels**

If wheels or tires are installed that are a different size than the original equipment wheels and tires, vehicle performance, including its braking, ride and handling characteristics, stability, and resistance to rollover may be affected. If the vehicle has electronic systems such as antilock brakes, rollover airbags, traction control, electronic stability control, or All-Wheel Drive, the performance of these systems can also be affected.

 **WARNING**

If different sized wheels are used, there may not be an acceptable level of performance and safety if tires not recommended for those wheels are selected. This increases the chance of a crash and serious injury. Only use GM specific wheel and tire systems developed for the vehicle, and have them properly installed by a GM certified technician.

See *Buying New Tires on page 10-65* and *Accessories and Modifications on page 10-3*.

## Uniform Tire Quality Grading

Quality grades can be found where applicable on the tire sidewall between tread shoulder and maximum section width. For example:

### **Treadwear 200 Traction AA Temperature A**

The following information relates to the system developed by the United States National Highway Traffic Safety Administration (NHTSA), which grades tires by treadwear, traction, and temperature performance. This applies only to vehicles sold in the United States. The grades are molded on the sidewalls of most passenger car tires. The Uniform Tire Quality Grading (UTQG) system does not apply to deep tread, winter tires, compact spare tires, tires with

nominal rim diameters of 10 to 12 inches (25 to 30 cm), or to some limited-production tires.

While the tires available on General Motors passenger cars and light trucks may vary with respect to these grades, they must also conform to federal safety requirements and additional General Motors Tire Performance Criteria (TPC) standards.

All Passenger Car Tires Must Conform to Federal Safety Requirements In Addition To These Grades.

### **Treadwear**

The treadwear grade is a comparative rating based on the wear rate of the tire when tested under controlled conditions on a specified government test course. For example, a tire

graded 150 would wear one and one-half (1½) times as well on the government course as a tire graded 100. The relative performance of tires depends upon the actual conditions of their use, however, and may depart significantly from the norm due to variations in driving habits, service practices and differences in road characteristics and climate.

### **Traction – AA, A, B, C**

The traction grades, from highest to lowest, are AA, A, B, and C. Those grades represent the tire's ability to stop on wet pavement as measured under controlled conditions on specified government test surfaces of asphalt and concrete. A tire marked C may have poor traction performance. **Warning:** The traction grade assigned to this tire is based on

straight-ahead braking traction tests, and does not include acceleration, cornering, hydroplaning, or peak traction characteristics.

### **Temperature – A, B, C**

The temperature grades are A (the highest), B, and C, representing the tire's resistance to the generation of heat and its ability to dissipate heat when tested under controlled conditions on a specified indoor laboratory test wheel. Sustained high temperature can cause the material of the tire to degenerate and reduce tire life, and excessive temperature can lead to sudden tire failure. The grade C corresponds to a level of performance which all passenger car tires must meet under the Federal Motor Safety Standard No. 109. Grades B and A represent higher levels of

performance on the laboratory test wheel than the minimum required by law. **Warning:** The temperature grade for this tire is established for a tire that is properly inflated and not overloaded. Excessive speed, underinflation, or excessive loading, either separately or in combination, can cause heat buildup and possible tire failure.

### **Wheel Alignment and Tire Balance**

The tires and wheels were aligned and balanced at the factory to provide the longest tire life and best overall performance. Adjustments to wheel alignment and tire balancing will not be necessary on a regular basis. However, check the alignment if there is unusual tire wear or if the vehicle is pulling to one side or the other. If the vehicle vibrates when driving on a smooth

road, the tires and wheels might need to be rebalanced. See your dealer for proper diagnosis.

## Wheel Replacement

Replace any wheel that is bent, cracked, or badly rusted or corroded. If wheel nuts keep coming loose, the wheel, wheel bolts and wheel nuts should be replaced. If the wheel leaks air, replace it. Some aluminum wheels can be repaired. See your dealer if any of these conditions exist.

Your dealer will know the kind of wheel that is needed.

Each new wheel should have the same load-carrying capacity, diameter, width, offset and be mounted the same way as the one it replaces.

Replace wheels, wheel bolts, wheel nuts, or Tire Pressure Monitor System (TPMS) sensors with new GM original equipment parts.

### WARNING

Using the wrong replacement wheels, wheel bolts, or wheel nuts can be dangerous. It could affect the braking and handling of the vehicle. Tires can lose air, and cause loss of control, causing a crash. Always use the correct wheel, wheel bolts, and wheel nuts for replacement.

**Notice:** The wrong wheel can also cause problems with bearing life, brake cooling, speedometer or odometer calibration, headlamp aim, bumper height, vehicle ground clearance, and tire or tire chain clearance to the body and chassis.

Whenever a wheel, wheel bolt, or wheel nut is replaced on a dual wheel setup, check the wheel nut torque after 160, 1 600 and 10 000 km (100, 1,000 and 6,000 mi) of driving. For proper torque, see “Wheel Nut Torque” under *Capacities and Specifications on page 12-2*.

See *If a Tire Goes Flat on page 10-70* for more information.

### Used Replacement Wheels

### WARNING

Replacing a wheel with a used one is dangerous. How it has been used or how far it has been driven may be unknown. It could fail suddenly and cause a crash. When replacing wheels, use a new GM original equipment wheel.

### Tire Chains

#### WARNING

If the vehicle has dual wheels or P265/65R18, P275/55R20, LT265/70R17, LT265/70R18, LT265/60R20, P285/50R20, P285/45R22 or 285/45R22 size tires, do not use tire chains. They can damage the vehicle because there is not enough clearance. Tire chains used on a vehicle without the proper amount of clearance can cause damage to the brakes, suspension, or other vehicle parts. The area damaged by the tire chains could cause you to lose control of the vehicle and you or others may be injured in a crash.

Use another type of traction device only if its manufacturer recommends it for use on the vehicle and tire size combination

(Continued)

#### WARNING (Continued)

and road conditions. Follow that manufacturer's instructions. To help avoid damage to the vehicle, drive slowly, readjust, or remove the device if it is contacting the vehicle, and do not spin the vehicle's wheels.

If you do find traction devices that will fit, install them on the rear tires.

**Notice:** If the vehicle does not have dual wheels and has a tire size other than P265/65R18, P275/55R20, LT265/70R17, LT265/70R18, LT265/60R20, P285/50R20, P285/45R22, or 285/45R22, use tire chains only where legal and only when you must. Use chains that are the proper size for the tires. Install them on the tires of the rear axle. Do not use chains on the tires of the front axle. Tighten them as tightly as possible with the ends securely

fastened. Drive slowly and follow the chain manufacturer's instructions. If you can hear the chains contacting the vehicle, stop and retighten them. If the contact continues, slow down until it stops. Driving too fast or spinning the wheels with chains on will damage the vehicle.

#### If a Tire Goes Flat

It is unusual for a tire to blowout while driving, especially if the tires are maintained properly. If air goes out of a tire, it is much more likely to leak out slowly. But if there ever is a blowout, here are a few tips about what to expect and what to do:

If a front tire fails, the flat tire creates a drag that pulls the vehicle toward that side. Take your foot off the accelerator pedal and grip the steering wheel firmly. Steer to maintain lane position, and then gently brake to a stop, well off the road, if possible.



A rear blowout, particularly on a curve, acts much like a skid and may require the same correction as used in a skid. Stop pressing the accelerator pedal and steer to straighten the vehicle. It may be very bumpy and noisy. Gently brake to a stop, well off the road, if possible.

 **WARNING**

Driving on a flat tire will cause permanent damage to the tire. Re-inflating a tire after it has been driven on while severely underinflated or flat may cause a blowout and a serious crash. Never attempt to re-inflate a tire that has been driven on while severely underinflated or flat. Have your dealer or an authorized tire service center repair or replace the flat tire as soon as possible.

 **WARNING**

Lifting a vehicle and getting under it to do maintenance or repairs is dangerous without the appropriate safety equipment and training. If a jack is provided with the vehicle, it is designed only for changing a flat tire. If it is used for anything else, you or others could be badly injured or killed if the vehicle slips off the jack. If a jack is provided with the vehicle, only use it for changing a flat tire.

If a tire goes flat, avoid further tire and wheel damage by driving slowly to a level place, well off the road, if possible. Turn on the hazard warning flashers. See *Hazard Warning Flashers on page 6-5*.

 **WARNING**

Changing a tire can be dangerous. The vehicle can slip off the jack and roll over or fall causing injury or death. Find a level place to change the tire. To help prevent the vehicle from moving:

1. Set the parking brake firmly.
2. Put an automatic transmission in P (Park) or a manual transmission in 1 (First) or R (Reverse).
3. For four-wheel-drive vehicles, be sure the transfer case is in a drive gear— not in N (Neutral).
4. Turn off the engine and do not restart while the vehicle is raised.
5. Do not allow passengers to remain in the vehicle.

(Continued)

## WARNING (Continued)

- Place wheel blocks on both sides of the tire at the opposite corner of the tire being changed.

When the vehicle has a flat tire (B), use the following example as a guide to assist in the placement of the wheel blocks (A).

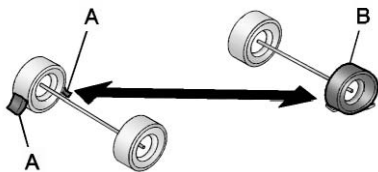

- A. Wheel Block
- B. Flat Tire

The following information explains how to use the jack and change a tire.

## Tire Changing

### Removing the Spare Tire and Tools

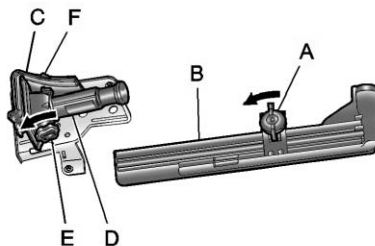

#### Crew Cab

- A. Wing Nut Retaining Tool Kit
- B. Tool Kit
- C. Wheel Blocks
- D. Jack
- E. Jack Knob
- F. Wing Nut Retaining Wheel Blocks

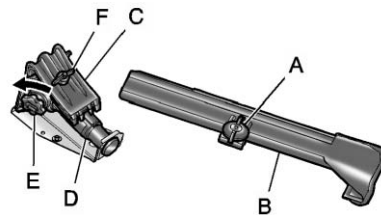

#### Regular Cab

- A. Wing Nut Retaining Tool Kit
- B. Tool Kit
- C. Wheel Blocks
- D. Jack
- E. Jack Knob
- F. Wing Nut Retaining Wheel Blocks

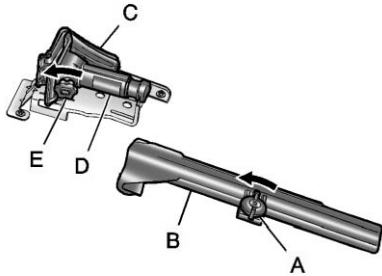

**Extended Cab**

- A. Wing Nut Retaining Tool Kit
- B. Tool Kit
- C. Wheel Blocks
- D. Jack
- E. Jack Knob

For regular cab models, the equipment you will need is behind the passenger seat. For extended and crew cab models, the equipment is on the shelf behind the passenger side second row seat.

1. Turn the knob on the jack counterclockwise to lower the jack head to release the jack from its holder.
2. Turn the wing nut counterclockwise to remove the wheel blocks and the wheel block retainer.
3. Turn the wing nut used to retain the storage bag and tools counterclockwise to remove it.

Use the jack handle extensions and the wheel wrench to remove the underbody-mounted spare tire.

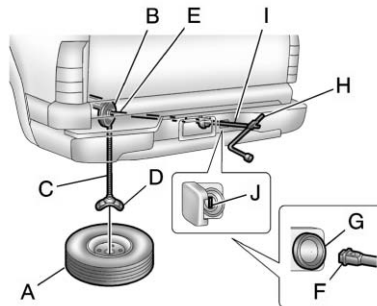

- A. Spare Tire (Valve Stem Pointed Down)
- B. Hoist Assembly
- C. Hoist Cable
- D. Tire/Wheel Retainer
- E. Hoist Shaft
- F. Hoist End of Extension Tool
- G. Hoist Shaft Access Hole
- H. Wheel Wrench
- I. Jack Handle Extensions
- J. Spare Tire Lock (If equipped)

1. Open the spare tire lock cover on the bumper and use the ignition key to remove the spare tire lock (J). To remove the spare tire lock, insert the ignition key turn and pull straight out.

## 10-74 Vehicle Care

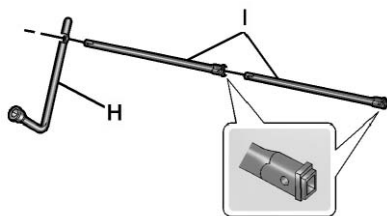

2. Assemble the wheel wrench (H) and the two jack handle extensions (I), as shown.

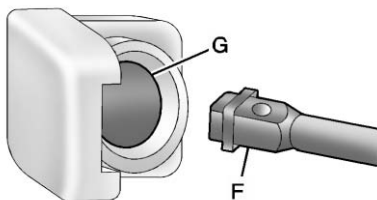

3. Insert the hoist end (open end) (F) of the extension through the hole (G) in the rear bumper.

Do not use the chiseled end of the wheel wrench.

Be sure the hoist end of the extension (F) connects to the hoist shaft. The ribbed square end of the extension is used to lower the spare tire.

4. Turn the wheel wrench counterclockwise to lower the spare tire to the ground. Continue to turn the wheel wrench until the spare tire can be pulled out from under the vehicle.
5. Pull the spare tire out from under the vehicle.

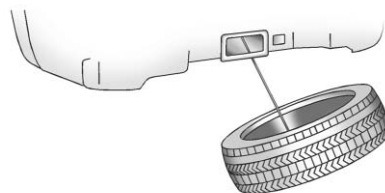

6. Tilt the tire toward the vehicle with some slack in the cable to access the tire/wheel retainer. Tilt the retainer and pull it through the center of the wheel along with the cable and spring.
7. Put the spare tire near the flat tire.

### Removing the Flat Tire and Installing the Spare Tire

Use the following pictures and instructions to remove the flat tire and raise the vehicle.

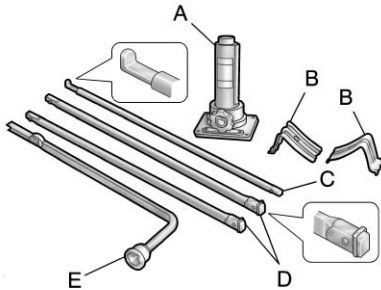

- A. Jack
- B. Wheel Blocks
- C. Jack Handle
- D. Jack Handle Extension
- E. Wheel Wrench

The tools you will be using include the jack (A), the wheel blocks (B), the jack handle (C), the jack handle extensions (D), and the wheel wrench (E).

1. Do a safety check before proceeding. See *If a Tire Goes Flat* on page 10-70 for more information.

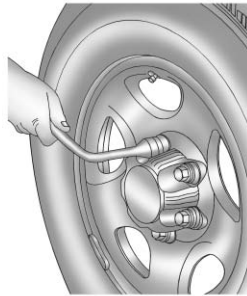

2. If the vehicle has wheel nut caps, loosen them by turning the wheel wrench counterclockwise.

If the vehicle has a center cap with wheel nut caps, the wheel nut caps are designed to stay with the center cap after they are loosened. Remove the entire center cap.

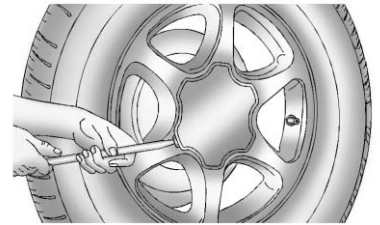

If the wheel has a smooth center cap, place the chisel end of the wheel wrench in the slot on the wheel, and gently pry it out.

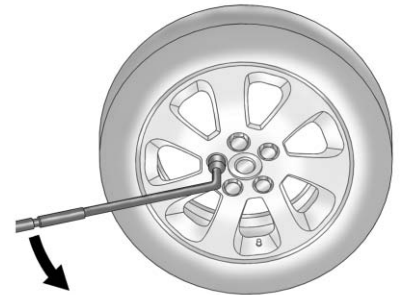

## 10-76 Vehicle Care

- Use the wheel wrench and turn it counterclockwise to loosen the wheel nuts. Do not remove the wheel nuts yet.

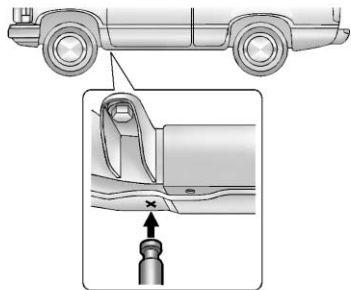

### Front Position - 1500 Models

- Position the jack under the vehicle, as shown. If the flat tire is on the front of the vehicle (1500 Model vehicles), position the jack under the bracket attached to the vehicle's frame, behind the flat tire.

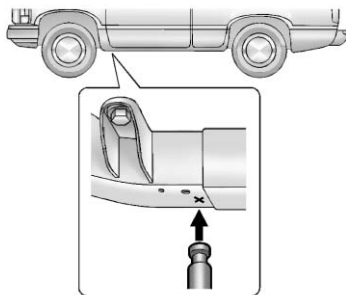

### Front Position - All Other Models

Position the jack under the vehicle, as shown. If the flat tire is on the front of the vehicle (all other models), position the jack on the frame behind the flat tire.

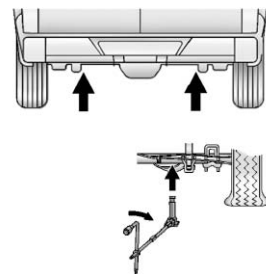

### Rear Position – 1500 Models

- If the flat tire is on the rear, for 1500 models position the jack under the rear axle about 5 cm (2 in) inboard of the shock absorber bracket.

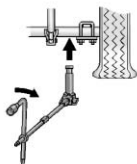
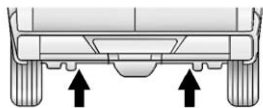

### Rear Position – All Other Models

For all other models, position the jack under the rear axle between the spring anchor and the shock absorber bracket.

If a snow plow has been added to the front of the vehicle, lower the snow plow fully before raising the vehicle.

Make sure that the jack head is positioned so that the rear axle is resting securely between the grooves that are on the jack head.

#### **WARNING**

Getting under a vehicle when it is lifted on a jack is dangerous. If the vehicle slips off the jack, you could be badly injured or killed. Never get under a vehicle when it is supported only by a jack.

#### **WARNING**

Raising the vehicle with the jack improperly positioned can damage the vehicle and even make the vehicle fall. To help avoid personal injury and vehicle damage, be sure to fit the jack lift head into the proper location before raising the vehicle.

6. Turn the wheel wrench clockwise to raise the vehicle. Raise the vehicle far enough off

the ground so there is enough room for the spare tire to fit under the wheel well.

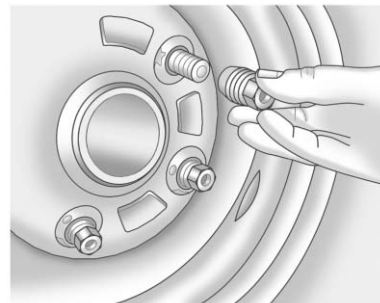

7. Remove all the wheel nuts and take off the flat tire.

#### **WARNING**

Rust or dirt on a wheel, or on the parts to which it is fastened, can make wheel nuts become loose after time. The wheel could come off and cause an accident. When

(Continued)

**WARNING (Continued)**

changing a wheel, remove any rust or dirt from places where the wheel attaches to the vehicle. In an emergency, a cloth or a paper towel can be used; however, use a scraper or wire brush later to remove all rust or dirt.

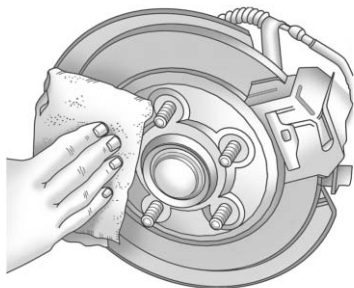

8. Remove any rust or dirt from the wheel bolts, mounting surfaces, and spare wheel.
9. Install the spare tire.

**⚠ WARNING**

Never use oil or grease on bolts or nuts because the nuts might come loose. The vehicle's wheel could fall off, causing a crash.

10. Put the wheel nuts back on with the rounded end of the nuts toward the wheel.
11. Tighten each wheel nut by hand. Then use the wheel wrench to tighten the nuts until the wheel is held against the hub.
12. Turn the wheel wrench counterclockwise to lower the vehicle. Lower the jack completely.

**⚠ WARNING**

If wheel studs are damaged, they can break. If all the studs on a wheel broke, the wheel could

(Continued)

**WARNING (Continued)**

come off and cause a crash. If any stud is damaged because of a loose-running wheel, it could be that all of the studs are damaged. To be sure, replace all studs on the wheel. If the stud holes in a wheel have become larger, the wheel could collapse in operation. Replace any wheel if its stud holes have become larger or distorted in any way. Inspect hubs and hub-piloted wheels for damage. Because of loose running wheels, piloting pad damage may occur and require replacement of the entire hub, for proper centering of the wheels. When replacing studs, hubs, wheel nuts or wheels, be sure to use GM original equipment parts.



**⚠ WARNING**

Wheel nuts that are improperly or incorrectly tightened can cause the wheels to become loose or come off. The wheel nuts should be tightened with a torque wrench to the proper torque specification after replacing. Follow the torque specification supplied by the aftermarket manufacturer when using accessory locking wheel nuts. See *Capacities and Specifications* on page 12-2 for original equipment wheel nut torque specifications.

**Notice:** Improperly tightened wheel nuts can lead to brake pulsation and rotor damage. To avoid expensive brake repairs, evenly tighten the wheel nuts in the proper sequence and to the proper torque specification. See *Capacities and Specifications* on page 12-2 for the wheel nut torque specification.

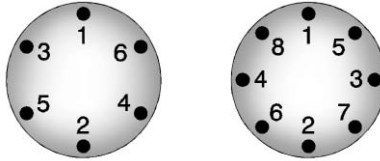

13. Tighten the nuts firmly in a crisscross sequence, as shown, by turning the wheel wrench clockwise.

For vehicles with dual wheels, have a technician check the wheel nut tightness of all wheels with a torque wrench after the first 160 km (100 mi) and then 1600 km (1,000 mi) after that. Repeat this service whenever you have a tire removed or serviced. See *Capacities and Specifications* on page 12-2 for more information.

When reinstalling the regular wheel and tire, also reinstall either the center cap, or bolt-on hub cap, depending on what the vehicle is equipped with. For center caps, place the cap on the wheel and tap it into place until it seats flush with the wheel. The cap only goes on one way. Be sure to line up the tab on the center cap with the indentation on the wheel. For bolt-on hub caps, align the plastic nut caps with the wheel nuts and then tighten by hand. Then use the wheel wrench to tighten.

**Storing a Flat or Spare Tire and Tools**

**⚠ WARNING**

Storing a jack, a tire, or other equipment in the passenger compartment of the vehicle could cause injury. In a sudden stop or collision, loose equipment could strike someone. Store all these in the proper place.

## 10-80 Vehicle Care

**Notice:** Storing an aluminum wheel with a flat tire under your vehicle for an extended period of time or with the valve stem pointing up can damage the wheel. Always stow the wheel with the valve stem pointing down and have the wheel/tire repaired as soon as possible.

Store the tire under the rear of the vehicle in the spare tire carrier.

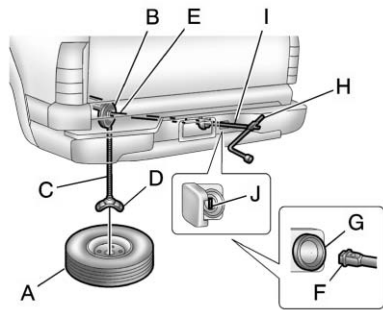

- A. Flat or Spare Tire (Valve Stem Pointed Down)
- B. Hoist Assembly
- C. Hoist Cable
- D. Tire/Wheel Retainer
- E. Hoist Shaft
- F. Hoist End of Extension Tool
- G. Hoist Shaft Access Hole
- H. Wheel Wrench
- I. Jack Handle Extensions
- J. Spare Tire Lock (If Equipped)

1. Put the tire on the ground at the rear of the vehicle with the valve stem pointed down, and to the rear.
2. Pull the cable and spring through the center of the wheel. Tilt the wheel retainer plate down and through the center wheel.

Make sure the retainer is fully seated across the underside of the wheel.

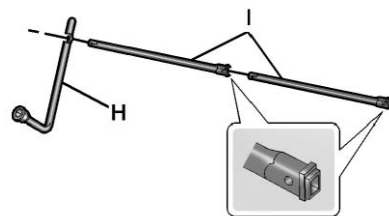

3. Attach the wheel wrench (H) and extensions (I) together, as shown.

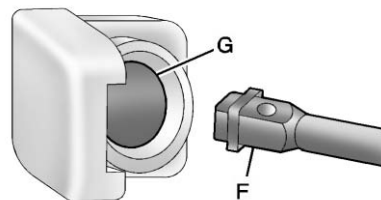

4. Insert the hoist end (F) through the hole (G) in the rear bumper and onto the hoist shaft.

Do not use the chiseled end of the wheel wrench.

- 5. Raise the tire part way upward. Make sure the retainer is seated in the wheel opening.
- 6. Raise the tire fully against the underside of the vehicle by turning the wheel wrench clockwise until you hear two clicks or feel it skip twice. You cannot overtighten the cable.

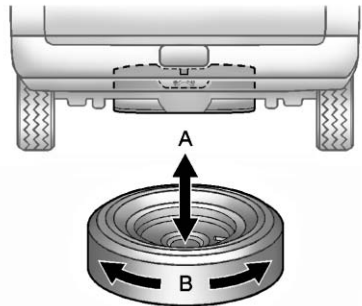

- 7. Make sure the tire is stored securely. Push, pull (A), and then try to turn (B) the tire. If the tire moves, use the wheel wrench to tighten the cable.

- 8. Reinstall the spare tire lock, if the vehicle has one.

To store the jack and jack tools:

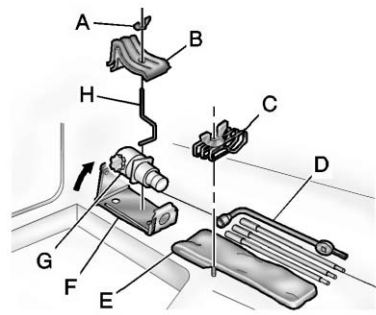

- A. Wing Nut Retaining Wheel Blocks
- B. Wheel Blocks
- C. Wing Nut Retaining Tool Kit
- D. Wheel Wrench and Extensions
- E. Tool Bag
- F. Jack Mounting Bracket

- G. Jack
- H. Bolt Retaining Wheel Blocks
- 1. Put the tools (D) in the tool bag (E) and place them in the retaining bracket (C).
- 2. Tighten down the wing nut (C).
- 3. Assemble the wheel blocks (B) and jack (G) together with the wing nut (A) and retaining bolt (H).
- 4. Position the jack (G) in the mounting bracket (F). Position the holes in the base of the jack (G) onto the pin in the mounting bracket (F).
- 5. Return them to their original location in the vehicle. For more information, refer to "Removing the Spare Tire and Tools" for more information.

## Full-Size Spare Tire

Your vehicle, when new, had a fully-inflated spare tire. A spare tire may lose air over time, so check its inflation pressure regularly. See *Tire Pressure on page 10-55* and *Vehicle Load Limits on page 9-15* for information regarding proper tire inflation and loading your vehicle. For instruction on how to remove, install or store a spare tire, see “Removing the Flat Tire and Installing the Spare” and “Storing a Flat or Spare Tire and Tools” under *Tire Changing on page 10-72*.

**Notice:** If the vehicle has four-wheel drive and a different size spare tire is installed, do not drive in four-wheel drive until the flat tire is repaired and/or replaced. The vehicle could be damaged and the repairs would not be covered by the warranty. Never use four-wheel drive when a different size spare tire is installed on the vehicle.

Your vehicle may have a different size spare tire than the road tires originally installed on your vehicle. This spare tire was developed for use on your vehicle, so it is all right to drive on it. If your vehicle has four-wheel drive and the different size spare tire is installed, keep the vehicle in two-wheel drive.

After installing the spare tire on your vehicle, you should stop as soon as possible and make sure the spare tire is correctly inflated. Have the damaged or flat road tire repaired or replaced as soon as you can and installed back onto your vehicle. This way, the spare tire will be available in case you need it again.

Do not mix tires and wheels of different sizes, because they will not fit. Keep your spare tire and its wheel together. If your vehicle has a spare tire that does not match your vehicle's original road tires and wheels in size and type, do not include the spare in the tire rotation.

## Jump Starting

For more information about the vehicle battery, see *Battery on page 10-27*.

If the vehicle is a hybrid, see the hybrid supplement for more information.

If the vehicle's battery (or batteries) has run down, you may want to use another vehicle and some jumper cables to start your vehicle. Be sure to use the following steps to do it safely.

### WARNING

Batteries can hurt you. They can be dangerous because:

- They contain acid that can burn you.
- They contain gas that can explode or ignite.
- They contain enough electricity to burn you.

(Continued)

**WARNING (Continued)**

If you do not follow these steps exactly, some or all of these things can hurt you.

**Notice:** Ignoring these steps could result in costly damage to the vehicle that would not be covered by the warranty.

**Trying to start the vehicle by pushing or pulling it will not work, and it could damage the vehicle.**

1. Check the other vehicle. It must have a 12-volt battery with a negative ground system.

**Notice:** Only use a vehicle that has a 12-volt system with a negative ground for jump starting. If the other vehicle does not have a 12-volt system with a negative ground, both vehicles can be damaged.

2. If you have a vehicle with a diesel engine with two batteries, you should know before you begin that, especially in cold weather, you may not be able to get enough power from a single battery in another vehicle to start your diesel engine. If your vehicle has more than one battery, using the battery that is closer to the starter will reduce electrical resistance. This is located on the passenger side, in the rear of the engine compartment.
3. Get the vehicles close enough so the jumper cables can reach, but be sure the vehicles are not touching each other. If they are, it could cause an unwanted ground connection. You would not be able to start your vehicle, and the bad grounding could damage the electrical systems.

To avoid the possibility of the vehicles rolling, set the parking brake firmly on both vehicles involved in the jump start

procedure. Put the automatic transmission in P (Park) or a manual transmission in Neutral before setting the parking brake. If you have a four-wheel-drive vehicle, be sure the transfer case is in a drive gear, not in Neutral.

**Notice:** If any accessories are left on or plugged in during the jump starting procedure, they could be damaged. The repairs would not be covered by the vehicle warranty. Whenever possible, turn off or unplug all accessories on either vehicle when jump starting the vehicle.

4. Turn off the ignition on both vehicles. Unplug unnecessary accessories plugged into the accessory power outlets. Turn off the radio and all the lamps that are not needed. This will avoid sparks and help save both batteries. And it could save the radio!

## 10-84 Vehicle Care

5. Open the hood on the other vehicle and locate the positive (+) and negative (-) terminal locations on that vehicle.

The positive (+) terminal, is located under a red plastic cover at the positive battery post. To uncover the positive (+) terminal, open the red plastic cover.

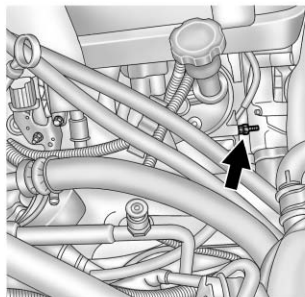

If your vehicle has a gasoline engine, the remote negative (-) terminal is a stud located on the right front of the engine, where the negative battery cable attaches.

If your vehicle has a diesel engine, the remote negative (-) terminal is the negative (-) post on the auxiliary battery on the driver side of the engine compartment.

For more information on the location of the remote positive (+) and remote negative (-) terminals, see *Engine Compartment Overview* on page 10-5

### **WARNING**

An electric fan can start up even when the engine is not running and can injure you. Keep hands, clothing and tools away from any underhood electric fan.

### **WARNING**

Using an open flame near a battery can cause battery gas to explode. People have been hurt doing this, and some have been blinded. Use a flashlight if you need more light.

Be sure the battery has enough water. You do not need to add water to the battery installed in your new vehicle. But if a battery has filler caps, be sure the right amount of fluid is there. If it is low, add water to take care of that first. If you do not, explosive gas could be present.

Battery fluid contains acid that can burn you. Do not get it on you. If you accidentally get it in your eyes or on your skin, flush the place with water and get medical help immediately.

**⚠ WARNING**

Fans or other moving engine parts can injure you badly. Keep your hands away from moving parts once the engine is running.

6. Check that the jumper cables do not have loose or missing insulation. If they do, you could get a shock. The vehicles could be damaged too.

Before you connect the cables, here are some basic things you should know. Positive (+) will go to positive (+) or to a remote positive (+) terminal if the vehicle has one. Negative (-) will go to a heavy, unpainted metal engine part or to a remote negative (-) terminal if the vehicle has one.

Do not connect positive (+) to negative (-) or you will get a short that would damage the battery and maybe other parts too. And do not connect the negative (-) cable to the negative (-) terminal on the dead battery because this can cause sparks.

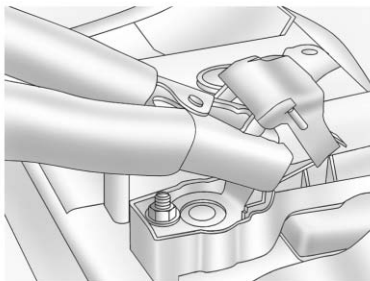

**5.3L Engine (4.3L, 4.8L, 6.0L, 6.2L and 6.6L Similar)**

7. Connect the red positive (+) cable to the positive (+) terminal of the vehicle with the dead battery.

8. Do not let the other end touch metal. Connect it to the positive (+) terminal of the good battery. Use a remote positive (+) terminal if the vehicle has one.
9. Now connect the black negative (-) cable to the negative (-) terminal of the good battery. Use a remote negative (-) terminal if the vehicle has one.

Do not let the other end touch anything until the next step.

10. Connect the other end of the negative (-) cable to a heavy, unpainted metal engine part or to the remote negative (-) terminal, on the vehicle with the dead battery.
11. Start the vehicle with the good battery and run the engine for a while.

12. Try to start the vehicle that had the dead battery. If it will not start after a few tries, it probably needs service.

**Notice:** If the jumper cables are connected or removed in the wrong order, electrical shorting may occur and damage the vehicle. The repairs would not be covered by the vehicle warranty. Always connect and remove the jumper cables in the correct order, making sure that the cables do not touch each other or other metal.

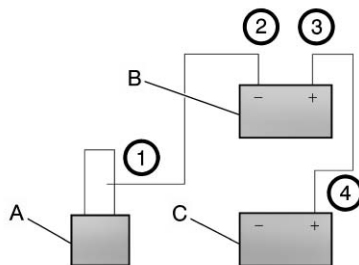

### Jumper Cable Removal

- Heavy, Unpainted Metal Engine Part or Remote Negative (-) Terminal
- Good Battery or Remote Positive (+) and Remote Negative (-) Terminals
- Dead Battery or Remote Positive (+) Terminal

To disconnect the jumper cables from both vehicles do the following:

- Disconnect the black negative (-) cable from the vehicle that had the bad battery.
- Disconnect the black negative (-) cable from the vehicle with the good battery.
- Disconnect the red positive (+) cable from the vehicle with the good battery.
- Disconnect the red positive (+) cable from the other vehicle.
- Return the positive (+) terminal cover, to its original position.



## Towing

### Towing the Vehicle

**Notice:** Incorrectly towing a disabled vehicle may cause damage. The damage would not be covered by the vehicle warranty.

Have the vehicle towed on a flatbed car carrier or a wheel lift tow truck. If a wheel lift tow truck is used, the drive wheels cannot contact the road while the vehicle is being towed. A wheel dolly must be used to lift all drive wheels off the ground.

Consult your dealer or a professional towing service if the disabled vehicle must be towed.

To tow the vehicle behind another vehicle for recreational purposes, such as behind a motor home, see "Recreational Vehicle Towing" in this section.

### Recreational Vehicle Towing

Recreational vehicle towing means towing the vehicle behind another vehicle, such as a motor home. The two most common types of recreational vehicle towing are known as dinghy towing and dolly towing. Dinghy towing is towing the vehicle with all four wheels on the ground. Dolly towing is towing the vehicle with two wheels on the ground and two wheels up on a device known as a dolly.

Here are some important things to consider before recreational vehicle towing:

- What is the towing capacity of the towing vehicle? Be sure to read the tow vehicle manufacturer's recommendations.
- What is the distance that will be travelled? Some vehicles have restrictions on how far and how long they can tow.

- Is the proper towing equipment going to be used? See your dealer or trailering professional for additional advice and equipment recommendations.
- Is the vehicle ready to be towed? Just as preparing the vehicle for a long trip, make sure the vehicle is prepared to be towed.

### Dinghy Towing

#### Two-Wheel-Drive Vehicles

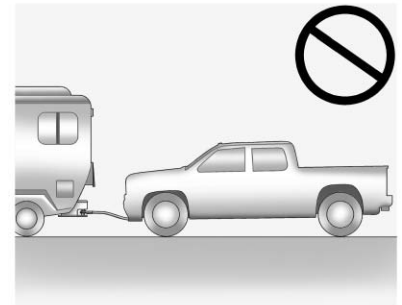

**Notice:** If the vehicle is towed with all four wheels on the ground, the drivetrain components could be damaged. The repairs would not be covered by the vehicle warranty. Do not tow the vehicle with all four wheels on the ground.

Two-wheel-drive vehicles should not be towed with all four wheels on the ground. Two-wheel-drive transmissions have no provisions for internal lubrication while being towed.

### Four-Wheel-Drive Vehicles

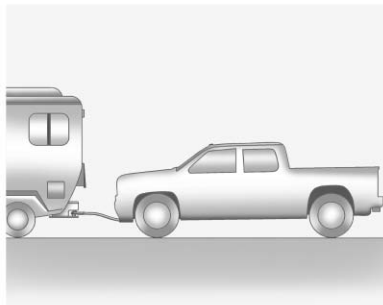

Use the following procedure to dinghy tow a four-wheel-drive vehicle:

1. Position the vehicle being towed behind the tow vehicle and shift the transmission to P (Park).
2. Turn the engine off and firmly set the parking brake.
3. Securely attach the vehicle being towed to the tow vehicle.

### WARNING

Shifting a four-wheel-drive vehicle's transfer case into N (Neutral) can cause the vehicle to roll even if the transmission is in P (Park). The driver or others could be injured. Make sure the parking brake is firmly set before the transfer case is shifted to N (Neutral).

4. Shift the transfer case to N (Neutral). See "Shifting into Neutral" under *Four-Wheel Drive on page 9-38* for the proper procedure to select the Neutral position for the vehicle.
5. Release the parking brake only after the vehicle being towed is firmly attached to the towing vehicle.
6. Turn the ignition to LOCK/OFF and remove the key — the steering wheel will still turn.

After towing, see “Shifting Out of Neutral” under *Four-Wheel Drive on page 9-38* for the proper procedure to take the vehicle out of the Neutral position.

### Dolly Towing

#### Front Towing (Front Wheels Off the Ground) – Two-Wheel-Drive Vehicles

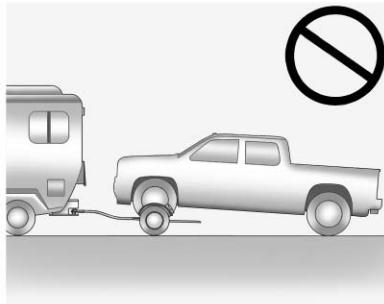

**Notice:** If a two-wheel drive vehicle is towed with the rear wheels on the ground, the transmission could be damaged.

**The repairs would not be covered by the vehicle warranty. Never tow the vehicle with the rear wheels on the ground.**

Two-wheel-drive vehicles should not be towed with the rear wheels on the ground. Two-wheel-drive transmissions have no provisions for internal lubrication while being towed.

To dolly tow a two-wheel-drive vehicle, the vehicle must be towed with the rear wheels on the dolly. See “Rear Towing (Rear Wheels Off the Ground)” later in this section for more information.

#### Front Towing (Front Wheels Off the Ground) – Four-Wheel-Drive Vehicles

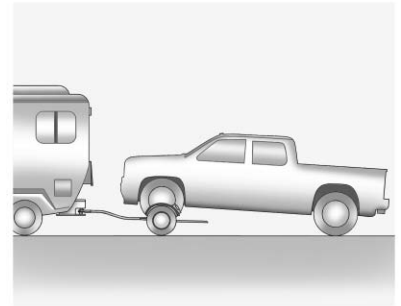

Use the following procedure to dolly tow a four-wheel-drive vehicle from the front:

1. Attach the dolly to the tow vehicle following the dolly manufacturer's instructions.
2. Drive the front wheels onto the dolly.
3. Shift the transmission to P (Park).
4. Firmly set the parking brake.

### WARNING

Shifting a four-wheel-drive vehicle's transfer case into N (Neutral) can cause the vehicle to roll even if the transmission is in P (Park). The driver or others could be injured. Make sure the parking brake is firmly set before the transfer case is shifted to N (Neutral).

5. Use an adequate clamping device designed for towing to ensure that the front wheels are locked into the straight position.
6. Secure the vehicle to the dolly following the manufacturer's instructions.
7. Shift the transfer case to N (Neutral). See "Shifting into Neutral" under *Four-Wheel Drive* on page 9-38 for the proper procedure to select the neutral position for the vehicle.

8. Release the parking brake only after the vehicle being towed is firmly attached to the towing vehicle.

9. Turn the ignition to LOCK/OFF.

After towing, see "Shifting Out of Neutral" under *Four-Wheel Drive* on page 9-38.

### Rear Towing (Rear Wheels Off the Ground)

#### Two-Wheel-Drive Vehicles

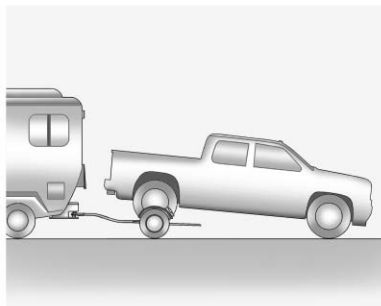

Use the following procedure to dolly tow a two-wheel-drive vehicle from the rear:

1. Attach the dolly to the tow vehicle following the dolly manufacturer's instructions.
2. Drive the rear wheels onto the dolly.
3. Firmly set the parking brake. See *Parking Brake* on page 9-51.
4. Put the transmission in P (Park).
5. Secure the vehicle to the dolly following the manufacturer's instructions.
6. Use an adequate clamping device designed for towing to ensure that the front wheels are locked into the straight position.
7. Turn the ignition to LOCK/OFF.

### Four-Wheel-Drive Vehicles

Use the following procedure to dolly tow a four-wheel-drive vehicle from the rear:

1. Attach the dolly to the tow vehicle following the dolly manufacturer's instructions.
2. Drive the rear wheels onto the dolly.
3. Firmly set the parking brake. See *Parking Brake on page 9-51*.
4. Put the transmission in P (Park).
5. Secure the vehicle to the dolly following the manufacturer's instructions.
6. Use an adequate clamping device designed for towing to ensure that the front wheels are locked into the straight position.

### WARNING

Shifting a four-wheel-drive vehicle's transfer case into N (Neutral) can cause the vehicle to roll even if the transmission is in P (Park). The driver or others could be injured. Make sure the parking brake is firmly set before the transfer case is shifted to N (Neutral).

7. Shift the transfer case to N (Neutral). See "Shifting into Neutral" under *Four-Wheel Drive on page 9-38* for the proper procedure to select the neutral position for the vehicle.
8. Turn the ignition to LOCK/OFF.

After towing, see "Shifting Out of Neutral" under *Four-Wheel Drive on page 9-38*.

## Appearance Care

### Exterior Care

#### Washing the Vehicle

To preserve the vehicle's finish, wash it often and out of direct sunlight.

**Notice:** Do not use petroleum-based, acidic, or abrasive cleaning agents as they can damage the vehicle's paint, metal, or plastic parts. If damage occurs, it would not be covered by the vehicle's warranty. Approved cleaning products can be obtained from your dealer. Follow all manufacturer directions regarding correct product usage, necessary safety precautions, and appropriate disposal of any vehicle care product.

**Notice:** Avoid using high-pressure washes closer than 30 cm (12 in) to the surface of the vehicle. Use of power washers exceeding 8,274 kPa (1,200 psi) can result in damage or removal of paint and decals.

Rinse the vehicle well, before washing and after, to remove all cleaning agents completely. If they are allowed to dry on the surface, they could stain.

Dry the finish with a soft, clean chamois or an all-cotton towel to avoid surface scratches and water spotting.

### Finish Care

Application of aftermarket clearcoat sealant/wax materials is not recommended. If painted surfaces are damaged, see your dealer to have the damage assessed and repaired. Foreign materials such as calcium chloride and other salts, ice melting agents, road oil and tar, tree sap, bird droppings, chemicals from industrial chimneys, etc., can

damage the vehicle's finish if they remain on painted surfaces. Wash the vehicle as soon as possible. If necessary, use non-abrasive cleaners that are marked safe for painted surfaces to remove foreign matter.

Occasional hand waxing or mild polishing should be done to remove residue from the paint finish. See your dealer for approved cleaning products.

Do not apply waxes or polishes to uncoated plastic, vinyl, rubber, decals, simulated wood, or flat paint as damage can occur.

**Notice:** Machine compounding or aggressive polishing on a basecoat/clearcoat paint finish may damage it. Use only non-abrasive waxes and polishes that are made for a basecoat/clearcoat paint finish on the vehicle.

To keep the paint finish looking new, keep the vehicle garaged or covered whenever possible.

### Protecting Exterior Bright Metal Parts

Regularly clean bright metal parts with water or chrome polish on chrome or stainless steel trim, if necessary.

For aluminum, never use auto or chrome polish, steam, or caustic soap to clean. A coating of wax, rubbed to a high polish, is recommended for all bright metal parts.

### Cleaning Exterior Lamps/Lenses and Emblems

Use only lukewarm or cold water, a soft cloth, and a car washing soap to clean exterior lamps, lenses and emblems. Follow instructions under "Washing the Vehicle" in this section.

### Windshield and Wiper Blades

Clean the outside of the windshield with glass cleaner.

Clean rubber blades using a lint-free cloth or paper towel soaked with windshield washer fluid or a mild detergent. Wash the windshield thoroughly when cleaning the blades. Bugs, road grime, sap, and a buildup of vehicle wash/wax treatments may cause wiper streaking.

Replace the wiper blades if they are worn or damaged. Damage can be caused by extreme dusty conditions, sand, salt, heat, sun, snow, and ice.

### Weatherstrips

Apply silicone grease on weatherstrips to make them last longer, seal better, and not stick or squeak. Lubricate weatherstrips once a year. Black marks from rubber material on painted surfaces can be removed by rubbing with a clean cloth. See *Recommended Fluids and Lubricants on page 11-12*.

### Tires

Use a stiff brush with tire cleaner to clean the tires.

**Notice:** Using petroleum-based tire dressing products on the vehicle may damage the paint finish and/or tires. When applying a tire dressing, always wipe off any overspray from all painted surfaces on the vehicle.

### Wheels and Trim — Aluminum or Chrome

Use a soft, clean cloth with mild soap and water to clean the wheels. After rinsing thoroughly with clean water, dry with a soft, clean towel. A wax may then be applied.

**Notice:** Chrome wheels and other chrome trim may be damaged if the vehicle is not washed after driving on roads that have been sprayed with magnesium, calcium, or sodium chloride.

These chlorides are used on roads for conditions such as ice and dust. Always wash the chrome with soap and water after exposure.

**Notice:** To avoid surface damage, do not use strong soaps, chemicals, abrasive polishes, cleaners, brushes, or cleaners that contain acid on aluminum or chrome-plated wheels. Use only approved cleaners. Also, never drive a vehicle with aluminum or chrome-plated wheels through an automatic car wash that uses silicone carbide tire cleaning brushes. Damage could occur and the repairs would not be covered by the vehicle warranty.

### Steering, Suspension, and Chassis Components

Visually inspect the front and rear suspension and steering system for damaged, loose, or missing parts or signs of wear. Inspect the power steering for proper hook-up, binding, leaks, cracks, chafing, etc. Visually

check constant velocity joints, rubber boots, and axle seals for leaks.

### **Body Component Lubrication**

Lubricate all key lock cylinders, hood hinges, liftgate hinges, and the steel fuel door hinge unless the components are plastic. Applying silicone grease on weatherstrips with a clean cloth will make them last longer, seal better, and not stick or squeak.

### **Underbody Maintenance**

Use plain water to flush dirt and debris from the vehicle's underbody. Your dealer or an underbody car washing system can do this. If not removed, rust and corrosion can develop.

### **Sheet Metal Damage**

If the vehicle is damaged and requires sheet metal repair or replacement, make sure the body repair shop applies anti-corrosion

material to parts repaired or replaced to restore corrosion protection.

Original manufacturer replacement parts will provide the corrosion protection while maintaining the vehicle warranty.

### **Finish Damage**

Quickly repair minor chips and scratches with touch-up materials available from your dealer to avoid corrosion. Larger areas of finish damage can be corrected in your dealer's body and paint shop.

### **Chemical Paint Spotting**

Airborne pollutants can fall upon and attack painted vehicle surfaces causing blotchy, ring-shaped discolorations, and small, irregular dark spots etched into the paint surface.

## **Interior Care**

To prevent dirt particle abrasions, regularly clean the vehicle's interior. Immediately remove any soils. Note that newspapers or dark garments that can transfer color to home furnishings can also permanently transfer color to the vehicle's interior.

Use a soft bristle brush to remove dust from knobs and crevices on the instrument cluster. Using a mild soap solution, immediately remove hand lotions, sunscreen, and insect repellent from all interior surfaces or permanent damage may result.

Your dealer may have products for cleaning the interior. Use cleaners specifically designed for the surfaces being cleaned to prevent permanent damage. Apply all cleaners directly to the cleaning cloth. Do not spray cleaners directly on any switches or controls. Cleaners should be removed quickly. Never allow cleaners to



remain on the surface being cleaned for extended periods of time.

Cleaners may contain solvents that can become concentrated in the interior. Before using cleaners, read and adhere to all safety instructions on the label. While cleaning the interior, maintain adequate ventilation by opening the doors and windows.

To prevent damage, do not clean the interior using the following cleaners or techniques:

- Never use a razor or any other sharp object to remove a soil from any interior surface.
- Never use a brush with stiff bristles.
- Never rub any surface aggressively or with excessive pressure.
- Do not use laundry detergents or dishwashing soaps with degreasers. For liquid cleaners,

use approximately 20 drops per 3.78 L (1 gal) of water.

A concentrated soap solution will leave a residue that creates streaks and attracts dirt. Do not use solutions that contain strong or caustic soap.

- Do not heavily saturate the upholstery when cleaning.
- Do not use solvents or cleaners containing solvents.

### Interior Glass

To clean, use a terry cloth fabric dampened with water. Wipe droplets left behind with a clean dry cloth. Commercial glass cleaners may be used, if necessary, after cleaning the interior glass with plain water.

**Notice: To prevent scratching, never use abrasive cleaners on automotive glass. Abrasive cleaners or aggressive cleaning may damage the rear window defogger.**

**Notice: Cleaning the windshield with water during the first three to six months of ownership will reduce tendency to fog.**

### Speaker Covers

Vacuum around a speaker cover gently, so that the speaker will not be damaged. Clean spots with just water and mild soap.

### Coated Moldings

Coated moldings should be cleaned.

- When lightly soiled, wipe with a sponge or soft lint-free cloth dampened with water.
- When heavily soiled, use warm soapy water.

### Fabric/Carpet/Suede

Start by vacuuming the surface using a soft brush attachment. If a rotating brush attachment is being used during vacuuming, only use it on the floor carpet. Before cleaning, gently remove as much of the soil as possible using one of the following techniques:

- Gently blot liquids with a paper towel. Continue blotting until no more soil can be removed.
- For solid soils, remove as much as possible prior to vacuuming.

To clean:

1. Saturate a clean lint-free colorfast cloth with water or club soda. Microfiber cloth is recommended to prevent lint transfer to the fabric or carpet.
2. Remove excess moisture by gently wringing until water does not drip from the cleaning cloth.

3. Start on the outside edge of the soil and gently rub toward the center. Rotate the cleaning cloth to a clean area frequently to prevent forcing the soil in to the fabric.
4. Continue gently rubbing the soiled area until there is no longer any color transfer from the soil to the cleaning cloth.
5. If the soil is not completely removed, use a mild soap solution followed only by club soda or plain water.

If the soil is not completely removed, it may be necessary to use a commercial upholstery cleaner or spot lifter. Test a small hidden area for colorfastness before using a commercial upholstery cleaner or spot lifter. If ring formation occurs, clean the entire fabric or carpet.

Following the cleaning process, a paper towel can be used to blot excess moisture.

### Cleaning High Gloss Surfaces and Vehicle Information and Radio Displays

For vehicles with high gloss surfaces or vehicle displays, use a microfiber cloth to wipe surfaces. Before wiping the surface with the microfiber cloth, use a soft bristle brush to remove dirt that could scratch the surface. Then use the microfiber cloth by gently rubbing to clean. Never use window cleaners or solvents. Periodically hand wash the microfiber cloth separately, using mild soap. Do not use bleach or fabric softener. Rinse thoroughly and air dry before next use.

**Notice:** Do not attach a device with a suction cup to the display. This may cause damage and would not be covered by the warranty.

## Instrument Panel, Leather, Vinyl, & Other Plastic Surfaces

Use a soft microfiber cloth dampened with water to remove dust and loose dirt. For a more thorough cleaning, use a soft microfiber cloth dampened with a mild soap solution.

**Notice:** Soaking or saturating leather, especially perforated leather, as well as other interior surfaces, may cause permanent damage. Wipe excess moisture from these surfaces after cleaning and allow them to dry naturally. Never use heat, steam, spot lifters, or spot removers. Do not use cleaners that contain silicone or wax-based products. Cleaners containing these solvents can permanently change the appearance and feel of leather or soft trim and are not recommended.

Do not use cleaners that increase gloss, especially on the instrument panel. Reflected glare can decrease visibility through the windshield under certain conditions.

**Notice:** Use of air fresheners may cause permanent damage to plastics and painted surfaces. If an air freshener comes in contact with any plastic or painted surface in the vehicle, blot immediately and clean with a soft cloth dampened with a mild soap solution. Damage caused by air fresheners would not be covered by the vehicle warranty.

### Care of Safety Belts

Keep belts clean and dry.

#### WARNING

Do not bleach or dye safety belts. It may severely weaken them. In a crash, they might not be able to  
(Continued)

#### WARNING (Continued)

provide adequate protection. Clean safety belts only with mild soap and lukewarm water.

## Floor Mats

#### WARNING

If a floor mat is the wrong size or is not properly installed, it can interfere with the pedals. Interference with the pedals can cause unintended acceleration and/or increased stopping distance which can cause a crash and injury. Make sure the floor mat does not interfere with the pedals.

## 10-98 Vehicle Care

---

Use the following guidelines for proper floor mat usage.

- The original equipment floor mats were designed for the vehicle. If the floor mats need replacing, it is recommended that GM certified floor mats be purchased. Non-GM floor mats may not fit properly and may interfere with the pedals. Always check that the floor mats do not interfere with the pedals.
- Use the floor mat with the correct side up. Do not turn it over.
- Do not place anything on top of the driver side floor mat.
- Use only a single floor mat on the driver side.
- Do not place one floor mat on top of another.

## Service and Maintenance

### General Information

General Information ..... 11-1

### Maintenance Schedule

Maintenance Schedule ..... 11-3

### Special Application Services

Special Application  
Services ..... 11-8

### Additional Maintenance and Care

Additional Maintenance  
and Care ..... 11-9

### Recommended Fluids, Lubricants, and Parts

Recommended Fluids and  
Lubricants ..... 11-12  
Maintenance Replacement  
Parts ..... 11-14

### Maintenance Records

Maintenance Records ..... 11-16

## General Information

This maintenance section applies to vehicles with a gasoline engine. For diesel engine vehicles, see the maintenance schedule section in the Duramax diesel supplement.

Your vehicle is an important investment. This section describes the required maintenance for the vehicle. Follow this schedule to help protect against major repair expenses resulting from neglect or inadequate maintenance. It may also help to maintain the value of the vehicle if it is sold. It is the responsibility of the owner to have all required maintenance performed.

Your dealer has trained technicians who can perform required maintenance using genuine replacement parts. They have up-to-date tools and equipment for fast and accurate diagnostics. Many dealers have extended evening and Saturday hours, courtesy

transportation, and online scheduling to assist with service needs.

Your dealer recognizes the importance of providing competitively priced maintenance and repair services. With trained technicians, the dealer is the place for routine maintenance such as oil changes and tire rotations and additional maintenance items like tires, brakes, batteries, and wiper blades.

**Notice: Damage caused by improper maintenance can lead to costly repairs and may not be covered by the vehicle warranty. Maintenance intervals, checks, inspections, recommended fluids, and lubricants are important to keep the vehicle in good working condition.**

The Tire Rotation and Required Services are the responsibility of the vehicle owner. It is recommended to have your dealer perform these services every 12 000 km/7,500 mi.

## 11-2 Service and Maintenance

---

Proper vehicle maintenance helps to keep the vehicle in good working condition, improves fuel economy, and reduces vehicle emissions.

Because of the way people use vehicles, maintenance needs vary. There may need to be more frequent checks and services. The Additional Required Services - Normal are for vehicles that:

- Carry passengers and cargo within recommended limits on the Tire and Loading Information label. See *Vehicle Load Limits on page 9-15*.
- Are driven on reasonable road surfaces within legal driving limits.
- Use the recommended fuel. See *Recommended Fuel on page 9-66*.

Refer to the information in the Maintenance Schedule Additional Required Services - Normal chart.

The Additional Required Services - Severe are for vehicles that are:

- Mainly driven in heavy city traffic in hot weather.
- Mainly driven in hilly or mountainous terrain.
- Frequently towing a trailer.
- Used for high speed or competitive driving.
- Used for taxi, police, or delivery service.

Refer to the information in the Maintenance Schedule Additional Required Services - Severe chart.

### **WARNING**

Performing maintenance work can be dangerous and can cause serious injury. Perform maintenance work only if the required information, proper tools, and equipment are available. If they are not, see your dealer to have a trained technician do the work. See *Doing Your Own Service Work on page 10-3*.

## Maintenance Schedule

### Owner Checks and Services

#### At Each Fuel Stop

- Check the engine oil level. See *Engine Oil on page 10-6*.

#### Once a Month

- Check the tire inflation pressures. See *Tire Pressure on page 10-55*.
- Inspect the tires for wear. See *Tire Inspection on page 10-61*.
- Check the windshield washer fluid level. See *Washer Fluid on page 10-23*.

### Engine Oil Change

When the CHANGE ENGINE OIL SOON message displays, have the engine oil and filter changed within the next 1 000 km/600 mi. If driven under the best conditions, the engine oil life system might not indicate the need for vehicle service

for more than a year. The engine oil and filter must be changed at least once a year and the oil life system must be reset. Your trained dealer technician can perform this work. If the engine oil life system is reset accidentally, service the vehicle within 5 000 km/3,000 mi since the last service. Reset the oil life system when the oil is changed. See *Engine Oil Life System on page 10-9*.

### Tire Rotation and Required Services Every 12 000 km/ 7,500 mi

Rotate the tires, if recommended for the vehicle, and perform the following services. See *Tire Rotation on page 10-61*.

- Check engine oil level and oil life percentage. If needed, change engine oil and filter, and reset oil life system. See *Engine Oil on page 10-6* and *Engine Oil Life System on page 10-9*.

- Check engine coolant level. See *Engine Coolant on page 10-17*.
- Check windshield washer fluid level. See *Washer Fluid on page 10-23*.
- Visually inspect windshield wiper blades for wear, cracking, or contamination. See *Exterior Care on page 10-91*. Replace worn or damaged wiper blades. See *Wiper Blade Replacement on page 10-33*.
- Check tire inflation pressures. See *Tire Pressure on page 10-55*.
- Inspect tire wear. See *Tire Inspection on page 10-61*.
- Visually check for fluid leaks.
- Inspect engine air cleaner filter. See *Engine Air Cleaner/Filter on page 10-15*.
- Inspect brake system.

## 11-4 Service and Maintenance

---

- Visually inspect steering, suspension, and chassis components for damaged, loose, or missing parts or signs of wear. See *Exterior Care* on page 10-91.
- Check restraint system components. See *Safety System Check* on page 3-19.
- Visually inspect fuel system for damage or leaks.
- Visually inspect exhaust system and nearby heat shields for loose or damaged parts.
- Lubricate body components. See *Exterior Care* on page 10-91.
- Check starter switch. See *Starter Switch Check* on page 10-32.
- Check automatic transmission shift lock control function. See *Automatic Transmission Shift Lock Control Function Check* on page 10-32.
- Check ignition transmission lock. See *Ignition Transmission Lock Check* on page 10-32.
- Check parking brake and automatic transmission park mechanism. See *Park Brake and P (Park) Mechanism Check* on page 10-33.
- Check accelerator pedal for damage, high effort, or binding. Replace if needed.
- Visually inspect gas strut for signs of wear, cracks, or other damage. Check the hold open ability of the strut. See your dealer if service is required.
- Inspect sunroof track and seal, if equipped. See *Sunroof (Crew Cab)* on page 2-21 or *Sunroof (Extended Cab)* on page 2-20.
- Check hybrid low pressure coolant level, if equipped.
- Verify spare tire key lock operation and lubricate as needed. See *Tire Changing* on page 10-72.





## 11-6 Service and Maintenance

---

### Footnotes — Maintenance Schedule Additional Required Services — Normal

(1) Check all fuel and vapor lines and hoses for proper hook-up, routing, and condition. Check that the purge valve, if the vehicle has one, works properly. Replace as needed.

(2) Or every four years, whichever comes first.

(3) Do not directly power wash the transfer case output seals. High pressure water can overcome the seals and contaminate the transfer case fluid. Contaminated fluid will decrease the life of the transfer case and should be replaced.

(4) Or every five years, whichever comes first. See *Cooling System* on page 10-16.

(5) Or every 10 years, whichever comes first.

(6) Inspect for fraying, excessive cracking, or damage; replace, if needed.



## 11-8 Service and Maintenance

---

### Footnotes — Maintenance Schedule Additional Required Services — Severe

(1) Extreme service. For vehicles mainly driven off-road in four-wheel drive or used in farming, mining, forestry, Department of Natural Resources (DNR), or snow plowing.

(2) Check all fuel and vapor lines and hoses for proper hook-up, routing, and condition. Check that the purge valve, if the vehicle has one, works properly. Replace as needed.

(3) Or every four years, whichever comes first.

(4) Do not directly power wash the transfer case output seals. High pressure water can overcome the seals and contaminate the transfer case fluid. Contaminated fluid will decrease the life of the transfer case and should be replaced.

(5) Or every five years, whichever comes first. See *Cooling System on page 10-16*.

(6) Or every 10 years, whichever comes first.

(7) Inspect for fraying, excessive cracking, or damage; replace, if needed.

### Special Application Services

- Vehicles with Dual Wheels: Check dual wheel nut torque at 160 km/100 mi, 1 600 km/1,000 mi and 9 700 km/6,000 mi.
- Severe Commercial Use Vehicles Only: Lubricate chassis components every 5 000 km/3,000 mi.
- Have underbody flushing service performed once a year.

## Additional Maintenance and Care

Your vehicle is an important investment and caring for it properly may help to avoid future costly repairs. To maintain vehicle performance, additional maintenance services may be required. It is recommended that your dealer perform these services — their trained dealer technicians know your vehicle best. Your dealer can also perform a thorough assessment with a multi-point inspection to recommend when your vehicle may need attention. The following list is intended to explain the services and conditions to look for that may indicate services are required.

### Battery

The battery supplies power to start the engine and operate any additional electrical accessories.

- To avoid break-down or failure to start the vehicle, maintain a battery with full cranking power.
- Trained dealer technicians have the diagnostic equipment to test the battery and ensure that the connections and cables are corrosion-free.

### Belts

- Belts may need replacing if they squeak or show signs of cracking or splitting.
- Trained dealer technicians can inspect the belts and recommend replacement when necessary.

### Brakes

Brakes stop the vehicle and are crucial to safe driving.

- Signs of brake wear may include chirping, grinding, or squealing noises, or difficulty stopping.
- Trained dealer technicians have access to tools and equipment to inspect the brakes and recommend quality parts engineered for the vehicle.

### Fluids

Proper fluid levels and approved fluids protect the vehicle's systems and components. See *Recommended Fluids and Lubricants on page 11-12* for GM approved fluids.

- Engine oil and windshield washer fluid levels should be checked at every fuel fill.
- Instrument cluster lights may come on to indicate that fluids may be low and need to be filled.

## 11-10 Service and Maintenance

---

### Hoses

Hoses transport fluids and should be regularly inspected to ensure that there are no cracks or leaks. With a multi-point inspection, your dealer can inspect the hoses and advise if replacement is needed.

### Lamps

Properly working headlamps, taillamps, and brake lamps are important to see and be seen on the road.

- Signs that the headlamps need attention include dimming, failure to light, cracking, or damage. The brake lamps need to be checked periodically to ensure that they light when braking.
- With a multi-point inspection, your dealer can check the lamps and note any concerns.

### Shocks and Struts

Shocks and struts help aid in control for a smoother ride.

- Signs of wear may include steering wheel vibration, bounce/sway while braking, longer stopping distance, or uneven tire wear.
- As part of the multi-point inspection, trained dealer technicians can visually inspect the shocks and struts for signs of leaking, blown seals, or damage, and can advise when service is needed.

### Tires

Tires need to be properly inflated, rotated, and balanced. Maintaining the tires can save money, fuel, and can reduce the risk of tire failure.

- Signs that the tires need to be replaced include three or more visible treadwear indicators; cord or fabric showing through the

rubber; cracks or cuts in the tread or sidewall; or a bulge or split in the tire.

- Trained dealer technicians can inspect and recommend the right tires. Your dealer can also provide tire/wheel balancing services to ensure smooth vehicle operation at all speeds. Your dealer sells and services name brand tires.

### Vehicle Care

To help keep the vehicle looking like new, vehicle care products are available from your dealer. For information on how to clean and protect the vehicle's interior and exterior, see *Interior Care on page 10-94* and *Exterior Care on page 10-91*.

### Wheel Alignment

Wheel alignment is critical for ensuring that the tires deliver optimal wear and performance.

- Signs that the alignment may need to be adjusted include pulling, improper vehicle handling, or unusual tire wear.
- Your dealer has the required equipment to ensure proper wheel alignment.

### **Windshield**

For safety, appearance, and the best viewing, keep the windshield clean and clear.

- Signs of damage include scratches, cracks, and chips.
- Trained dealer technicians can inspect the windshield and recommend proper replacement if needed.

### **Wiper Blades**

Wiper blades need to be cleaned and kept in good condition to provide a clear view.

- Signs of wear include streaking, skipping across the windshield, and worn or split rubber.
- Trained dealer technicians can check the wiper blades and replace them when needed.

## Recommended Fluids, Lubricants, and Parts

### Recommended Fluids and Lubricants

This maintenance section applies to vehicles with a gasoline engine. If the vehicle has a diesel engine and/or an Allison Transmission, see the maintenance schedule section in the Duramax diesel supplement.

Fluids and lubricants identified below by name, part number, or specification can be obtained from your dealer.

<b>Usage</b>	<b>Fluid/Lubricant</b>
Engine Oil	Use only engine oil licensed to the dexos1 specification, or equivalent, of the proper SAE viscosity grade. ACDelco dexos1 Synthetic Blend is recommended. See <i>Engine Oil on page 10-6</i> .
Engine Coolant	50/50 mixture of clean, drinkable water and use only DEX-COOL coolant. See <i>Engine Coolant on page 10-17</i> .
Hydraulic Brake System	DOT 3 Hydraulic Brake Fluid (GM Part No. 12377967, in Canada 89021320).
Windshield Washer	Automotive windshield washer fluid that meets regional freeze protection requirements.
Power Steering System	GM Power Steering Fluid (GM Part No. 89021184, in Canada 89021186).
Automatic Transmission	DEXRON®-VI Automatic Transmission Fluid.
Key Lock Cylinders	Multi-Purpose Lubricant, Superlube (GM Part No. 12346241, in Canada 10953474).



<b>Usage</b>	<b>Fluid/Lubricant</b>
Floor Shift Linkage	Lubriplate Lubricant Aerosol (GM Part No. 89021668, in Canada 89021674) or lubricant meeting requirements of NLGI #2 Category LB or GC-LB.
Chassis Lubrication	Chassis Lubricant (GM Part No. 12377985, in Canada 88901242) or lubricant meeting requirements of NLGI #2, Category LB or GC-LB.
Front Axle (1500 Series) - Four-Wheel Drive	SAE 80W-90 Axle Lubricant (GM Part No. 89021671, in Canada 89021672).
Front Axle (1500, 2500 HD, and 3500 HD Series)	SAE 75W-90 Synthetic Axle Lubricant (GM Part No. 89021677, in Canada 89021678).
Rear Axle	SAE 75W-90 Synthetic Axle Lubricant (GM Part No. 89021677, in Canada 89021678).
Transfer Case (Four-Wheel Drive)	DEXRON <sup>®</sup> -VI Automatic Transmission Fluid.
Front Axle Propshaft Spline or One-Piece Propshaft Spline (Two-Wheel Drive with 4-Speed Auto. Trans.)	Spline Lubricant, Special Lubricant (GM Part No. 12345879, in Canada 10953511).
Rear Driveline Center Spline	Chassis Lubricant (GM Part No. 12377985, in Canada 88901242) or lubricant meeting requirements of NLGI #2, Category LB or GC-LB.
Hood Hinges	Multi-Purpose Lubricant, Superlube (GM Part No. 12346241, in Canada 10953474).

## 11-14 Service and Maintenance

---

Usage	Fluid/Lubricant
Body Door Hinge Pins, Tailgate Hinge and Linkage, and Fuel Door Hinge	Multi-Purpose Lubricant, Superlube (GM Part No. 12346241, in Canada 10953474).
Tailgate Handle Pivot Points, Hinges, Latch Bolt, and Linkage	Multi-Purpose Lubricant, Superlube (GM Part No. 12346241, in Canada 10953474).
Weatherstrip Conditioning	Weatherstrip Lubricant (GM Part No. 3634770, in Canada 10953518) or Dielectric Silicone Grease (GM Part No. 12345579, in Canada 10953481).
Weatherstrip Squeaks	Synthetic Grease with Teflon, Superlube (GM Part No. 12371287, in Canada 10953437).

## Maintenance Replacement Parts

Replacement parts identified below by name, part number, or specification can be obtained from your dealer.

If your vehicle has a diesel engine, see the Duramax diesel supplement for more information.

Part	GM Part Number	ACDelco Part Number
Engine Air Cleaner/Filter		
Standard Filter	15908916*	A3086C*
High Capacity Filter	15908915	A3085C

Part	GM Part Number	ACDelco Part Number
Oil Filter		
4.3L V6	25010792	PF47
4.8L V8; 5.3L V8; 6.0L V8; 6.2L V8	89017524	PF48
Spark Plugs		
4.3L V6	12568387	41-101
4.8L V8; 5.3L V8; 6.0L V8; 6.2L V8	12621258	41-110
Wiper Blades – 55.0 cm (21.6 in)	25877402	—
*15908915 (A3085C) high-capacity air cleaner filter may be substituted.		







## Technical Data

### Vehicle Identification

Vehicle Identification Number (VIN) .....	12-1
Service Parts Identification Label .....	12-1

### Vehicle Data

Capacities and Specifications .....	12-2
Engine Drive Belt Routing ...	12-6

## Vehicle Identification

### Vehicle Identification Number (VIN)



This legal identifier is in the front corner of the instrument panel, on the left side of the vehicle. It can be seen through the windshield from outside. The VIN also appears on the Vehicle Certification and Service Parts labels and certificates of title and registration.

### Engine Identification

The eighth character in the VIN is the engine code. This code identifies the vehicle's engine, specifications, and replacement parts. See "Engine Specifications" under *Capacities and Specifications* on page 12-2 for the vehicle's engine code.

### Service Parts Identification Label

This label, on the inside of the glove box, has the following information:

- Vehicle Identification Number (VIN).
- Model designation.
- Paint information.
- Production options and special equipment.

Do not remove this label from the vehicle.

## Vehicle Data

### Capacities and Specifications

The following approximate capacities are given in metric and English conversions. See *Recommended Fluids and Lubricants on page 11-12* for more information.

If the vehicle has a diesel engine, see the Duramax diesel supplement for more information.

Application	Capacities	
	Metric	English
Air Conditioning Refrigerant R134a	For the air conditioning system refrigerant charge amount, see the refrigerant label located under the hood. See your dealer for more information.	
Cooling System		
4.3L V6 1500 Series	15.6 L	16.5 qt
4.8L V8 1500 Series	16.0 L	16.9 qt
5.3L V8 1500 Series	16.0 L	16.9 qt
6.0L V8 2500 Series and 3500 Series	15.5 L	16.4 qt
6.2L V8 1500 Series	15.9 L	16.8 qt
Engine Oil with Filter		
4.3L V6	4.3 L	4.5 qt



<b>Application</b>	<b>Capacities</b>	
	<b>Metric</b>	<b>English</b>
4.8L V8; 5.3L V8; 6.0L V8; 6.2L V8	5.7 L	6.0 qt
<b>Fuel Tank</b>		
1500 Series Standard and Short Box	98.4 L	26.0 gal
1500 Series Long Box	128.7 L	34.0 gal
2500 Series and 3500 Series Standard Box	136.3 L	36.0 gal
2500 Series and 3500 Series Long Box	136.3 L	36.0 gal
3500 Series Chassis Cab	240.4 L	63.5 gal
3500 Chassis Cab – Front Tank	89.0 L	23.5 gal
3500 Chassis Cab – Rear Tank (if equipped)	151.4 L	40.0 gal
Transfer Case Fluid	1.5 L	1.6 qt
<b>Transmission Fluid - Automatic (Pan Removal and Filter Replacement)</b>		
4-Speed Transmission 4L60-E Electronic Transmission	4.7 L	5.0 qt
6-Speed Transmission 6L80-E	5.7 L	6.0 qt
6-Speed Transmission 6L90-E	6.0 L	6.3 qt
6-Speed Transmission Allison	7.0 L	7.4 qt

## 12-4 Technical Data

---

Application	Capacities	
	Metric	English
Transmission Fluid - Manual (Drain and Refill)		
1500 Series	4.4 L	4.6 qt
3500 Series	3.5 L	3.7 qt
Wheel Nut Torque	190 N•m	140 ft lb
All capacities are approximate. When adding, be sure to fill to the approximate level, as recommended in this manual. Recheck fluid level after filling.		

### Engine Specifications

Engine	VIN Code	Spark Plug Gap
4.3L V6 (LU3)	X	1.52 mm (0.060 in)
4.8L V8 (L20)	A	1.02 mm (0.040 in)
5.3L V8 FlexFuel with Active Fuel Management™ (Iron Block) (LMG)	0	1.02 mm (0.040 in)
5.3L V8 FlexFuel with Active Fuel Management™ (Aluminum Block) (LC9)	7	1.02 mm (0.040 in)

**Engine Specifications (cont'd)**

<b>Engine</b>	<b>VIN Code</b>	<b>Spark Plug Gap</b>
6.0L V8 FlexFuel with Active Fuel Management™(Aluminum Block)(LZ1)	J	1.02 mm (0.040 in)
6.0L V8 (Iron Block) (L96)	G	1.02 mm (0.040 in)
6.2L V8 FlexFuel (Aluminum Block) (L9H)	2	1.02 mm (0.040 in)

## Engine Drive Belt Routing

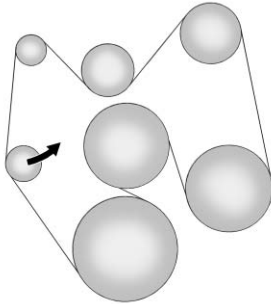

**V6 Engines**

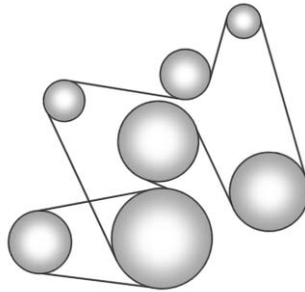

**V8 Engines**

If the vehicle has a diesel engine, see the Duramax diesel supplement for more information.

If the vehicle is a hybrid, see the hybrid supplement for more information.

# Customer Information

## Customer Information

- Customer Satisfaction Procedure (U.S. and Canada) ..... 13-2
- Customer Satisfaction Procedure (Mexico) ..... 13-4
- Customer Assistance Offices (U.S. and Canada) ..... 13-5
- Customer Assistance Offices (Mexico) ..... 13-5
- Customer Assistance for Text Telephone (TTY) Users (U.S. and Canada) ..... 13-6
- Online Owner Center ..... 13-6
- GM Mobility Reimbursement Program (U.S. and Canada) ..... 13-7

- Roadside Assistance Program (Mexico) ..... 13-7
- Roadside Assistance Program (U.S. and Canada) ..... 13-11
- Scheduling Service Appointments (U.S. and Canada) ..... 13-12
- Courtesy Transportation Program (U.S. and Canada) ..... 13-13
- Collision Damage Repair (U.S. and Canada) ..... 13-14
- Service Publications Ordering Information ..... 13-16

## Reporting Safety Defects

- Reporting Safety Defects to the United States Government ..... 13-17
- Reporting Safety Defects to the Canadian Government ..... 13-18
- Reporting Safety Defects to General Motors ..... 13-18

## Vehicle Data Recording and Privacy

- Vehicle Data Recording and Privacy ..... 13-19
- Event Data Recorders ..... 13-19
- OnStar® ..... 13-20
- Navigation System ..... 13-20
- Radio Frequency Identification (RFID) ..... 13-20
- Radio Frequency Statement ..... 13-20

### Customer Information

#### Customer Satisfaction Procedure (U.S. and Canada)

Your satisfaction and goodwill are important to your dealer and to GMC. Normally, any concerns with the sales transaction or the operation of the vehicle will be resolved by your dealer's sales or service departments. Sometimes, however, despite the best intentions of all concerned, misunderstandings can occur. If your concern has not been resolved to your satisfaction, the following steps should be taken:

**STEP ONE:** Discuss your concern with a member of dealership management. Normally, concerns can be quickly resolved at that level. If the matter has already been reviewed with the sales, service, or parts manager, contact the owner of your dealership or the general manager.

**STEP TWO:** If after contacting a member of dealership management, it appears your concern cannot be resolved by your dealership without further help, in the U.S., call 1-800-462-8782. In Canada, call General Motors of Canada Customer Care Centre at 1-800-263-3777 (English) or 1-800-263-7854 (French).

We encourage you to call the toll-free number in order to give your inquiry prompt attention. Have the following information available to give the Customer Assistance representative:

- Vehicle Identification Number (VIN). This is available from the vehicle registration or title, or the plate at the top left of the instrument panel and visible through the windshield.
- Dealership name and location.
- Vehicle delivery date and present mileage.

When contacting GMC, remember that your concern will likely be resolved at a dealer's facility. That is why we suggest following Step One first.

#### **STEP THREE — U.S. Owners:**

Both General Motors and your dealer are committed to making sure you are completely satisfied with the new vehicle. However, if you continue to remain unsatisfied after following the procedure outlined in Steps One and Two, you can file with the Better Business Bureau (BBB) Auto Line<sup>®</sup> Program to enforce your rights.

The BBB Auto Line Program is an out-of-court program administered by the Council of Better Business Bureaus to settle automotive disputes regarding vehicle repairs or the interpretation of the New Vehicle Limited Warranty. Although you may be required to resort to this informal dispute resolution program prior to filling out a court action, use of the program is free of charge and your case will generally be heard within

40 days. If you do not agree with the decision given in your case, you may reject it and proceed with any other venue for relief available to you.

You may contact the BBB Auto Line Program using the toll-free telephone number or write them at the following address:

BBB Auto Line Program  
Council of Better Business Bureaus,  
Inc.

4200 Wilson Boulevard  
Suite 800  
Arlington, VA 22203-1838

Telephone: 1-800-955-5100  
[www.dr.bbb.org/goauto](http://www.dr.bbb.org/goauto)

This program is available in all 50 states and the District of Columbia. Eligibility is limited by vehicle age, mileage, and other factors. General Motors reserves the right to change eligibility limitations and/or discontinue its participation in this program.

### **STEP THREE — Canadian**

**Owners:** In the event that you do not feel your concerns have been addressed after following the procedure outlined in Steps One and Two, General Motors of Canada Limited wants you to be aware of its participation in a no-charge Mediation/Arbitration Program. General Motors of Canada Limited has committed to binding arbitration of owner disputes involving factory-related vehicle service claims. The program provides for the review of the facts involved by an impartial third party arbiter, and may include an informal hearing before the arbiter. The program is designed so that the entire dispute settlement process, from the time you file your complaint to the final decision, should be completed in approximately 70 days. We believe our impartial program offers advantages over courts in most jurisdictions because it is informal, quick, and free of charge.

For further information concerning eligibility in the Canadian Motor Vehicle Arbitration Plan (CAMVAP), call toll-free 1-800-207-0685, or call the General Motors Customer Care Centre, 1-800-263-3777 (English), 1-800-263-7854 (French), or write to:

Mediation/Arbitration Program  
c/o Customer Care Centre  
General Motors of Canada Limited  
Mail Code: CA1-163-005  
1908 Colonel Sam Drive  
Oshawa, Ontario L1H 8P7

The inquiry should be accompanied by the Vehicle Identification Number (VIN).

### Customer Satisfaction Procedure (Mexico)



Did you get the Warranty Extension Plan? This plan is recommended by General Motors to supplement the warranty included with the new vehicle purchase.

See your dealer for details.

### Customer Assistance Procedure

Owner satisfaction and goodwill are very important to your dealer and General Motors.

Normally, any problem with the transaction, sale, or usage of the vehicle must be handled by your dealer sales or service departments.

However, we recognize that despite the good intentions of all parties involved, sometimes a misunderstanding may occur.

If you have a problem that has not been satisfactorily handled through the normal means, we suggest the following steps:

#### STEP ONE

Explain your case to your dealer service agent, service manager, dealer sales agent, or sales manager, depending on your case.

Make sure that they have all necessary information. They are interested in your continual satisfaction.

#### STEP TWO

If you are not satisfied, please contact the general manager or your dealership owner to ask for their help. If they are not able to resolve your case, ask them to contact the right people at General Motors for support, if needed.

#### STEP THREE

If your case is not resolved in a reasonable amount of time by your dealer, please call the General Motors Customer Assistance Center (CAC) and provide the following information:

- Name
- Address
- Phone number
- Model year
- Brand
- Vehicle Identification Number (VIN)
- Mileage
- Delivery date
- Description of the problem
- Dealership name
- Dealership address

See *Customer Assistance Offices (U.S. and Canada)* on page 13-5 or *Customer Assistance Offices (Mexico)* on page 13-5.



## Customer Assistance Offices (U.S. and Canada)

GMC encourages customers to call the toll-free number for assistance. However, if a customer wishes to write or e-mail GMC, the letter should be addressed to:

### United States and Puerto Rico

GMC Customer Assistance Center  
P.O. Box 33172  
Detroit, MI 48232-5172

[www.GMC.com](http://www.GMC.com)

1-800-GMC-8782 (1-800-462-8782)  
1-800-462-8583 (For Text Telephone Devices (TTYs))  
Roadside Assistance:  
1-888-881-3302

From U.S. Virgin Islands:  
1-800-496-9994

### Canada

General Motors of Canada Limited  
Customer Care Centre, Mail Code:  
CA1-163-005  
1908 Colonel Sam Drive  
Oshawa, Ontario L1H 8P7  
[www.gmc.ca](http://www.gmc.ca)

1-800-263-3777 (English)  
1-800-263-7854 (French)  
1-800-263-3830 (For Text Telephone Devices (TTYs))  
Roadside Assistance:  
1-800-268-6800

### All Overseas Locations

Please contact the local General Motors Business Unit.

## Customer Assistance Offices (Mexico)

To contact the Customer Assistance Center (CAC), use the phone numbers listed in this section. Customer assistance is available Monday through Friday, 08:00 to 20:00 hours, and Saturdays from 08:00 to 15:00 hours.

All e-mail inquiries to the Customer Assistance Center (CAC) should be sent to: [cac.gmc@gm.com](mailto:cac.gmc@gm.com).

### Mexico

#### From Mexico City

5329-0812

#### From Other Mexico Locations

01-800-466-0812

## 13-6 Customer Information

---

### United States and Canada

1-866-466-8191

### Costa Rica

00-800-052-1005

### Guatemala

1-800-999-5252

### Panama

00-800-052-0001

### Dominican Republic

1-888-751-5301

### El Salvador

800-6273

### Honduras

800-0122-6101

### Customer Assistance for Text Telephone (TTY) Users (U.S. and Canada)

To assist customers who are deaf, hard of hearing, or speech impaired and who use Text Telephones (TTYs), GMC has TTY equipment available at its Customer Assistance Center. Any TTY user can communicate with GMC by dialing: 1-800-462-8583. TTY users in Canada can dial 1-800-263-3830.

### Online Owner Center

#### Online Owner Experience (U.S.) [my.gmc.com](http://my.gmc.com)

The GMC online owner experience is a one-stop resource that allows interaction with GMC and keeps important vehicle-specific information in one place.

#### Membership Benefits

 **(Vehicle Information):** Download owner manuals and view vehicle-specific how-to videos.

 **(Maintenance Information):** View maintenance schedules, required alerts, OnStar onboard vehicle diagnostic information, and schedule service appointments.

 **(Service History):** View printable dealer-recorded service records and self-recorded service records.

 **(Preferred Dealer Information):** Select a preferred dealer and view dealer location, maps, phone numbers, and hours.

 **(Warranty Tracking Information):** Track the vehicle's warranty information.

 **(Recall Information):** View active recalls or search by Vehicle Identification Number (VIN). See *Vehicle Identification Number (VIN) on page 12-1*.

 **(Other Account Information):** View GM Card, SiriusXM Satellite radio, and OnStar account information.

**■ (Live Chat Support):** Chat live with online help representatives.

Visit [my.gmc.com](http://my.gmc.com) to register your vehicle.

### **GMC Owner Centre (Canada)** **gmcowner.ca**

Take a trip to the GMC Owner Centre:

- Chat live with online help representatives.
- Use the Vehicle Tools section.
- Access third party enthusiast sites and social media networks.
- Locate owner resources such as lease-end, financing, and warranty information.
- Retrieve your favorite articles, quizzes, tips and multimedia galleries organized into the Features and Auto Care Sections.
- Download the owner manual for your vehicle, quickly and easily.

- Find the GMC-recommended maintenance services for your vehicle.

### **GM Mobility Reimbursement Program (U.S. and Canada)**



This program is available to qualified applicants for cost reimbursement of eligible aftermarket adaptive equipment required for the vehicle, such as hand controls or a wheelchair/scooter lift for the vehicle.

For more information on the limited offer, visit [www.gmmobility.com](http://www.gmmobility.com) or call the GM Mobility Assistance Center at 1-800-323-9935. Text Telephone (TTY) users, call 1-800-833-9935.

General Motors of Canada also has a Mobility Program. Call 1-800-GM-DRIVE (463-7483) for details. TTY users call 1-800-263-3830.

### **Roadside Assistance Program (Mexico)**

As a new owner, your vehicle is automatically enrolled in the Roadside Assistance program. The services are available at no cost under the terms and conditions of the program. The Roadside Assistance program is not part of, or included, in the coverage provided by the new vehicle limited warranty.

Roadside Assistance provides assistance to the driver and passengers while driving the vehicle within your city of residence or on any passable road in Mexico, the United States, and Canada.

## 13-8 Customer Information

---

Services are subject to the limitations described in the following pages. Program coverage varies by country.

Roadside Assistance is available 24 hours a day, 365 days of the year.

This program expires two years from the date of the invoice for the vehicle, regardless of vehicle mileage and changes in vehicle ownership.

For more information about the renewal of this program at the end of its term, contact the GMC Customer Assistance Center at 01-800-466-0801.

### Services Provided

- **Flat Tire Change:** If unable to change a flat tire, Roadside Assistance will provide towing service to the nearest authorized GMC dealership. It is the owner's responsibility for the repair or replacement of the tire.

This service is limited to the transfer of the vehicle to the repair facility.

- **Emergency Fuel Delivery:** Delivery of enough fuel for the vehicle to get to the nearest service station.
- **Lock-Out Service:** Service to unlock the vehicle if you are locked out.
- **Battery Jump Start:** Service to jump start a dead battery.
- **\*Emergency Messages:** Transmission of urgent phone messages.
- **\*Emergency Calls:** Call for emergency services.
- **\*Dealership Location Assistance:** Information regarding addresses and telephone numbers for GMC dealers.

- **Emergency Towing:** Tow to the nearest dealer for warranty service if the vehicle cannot be driven.

If the vehicle is involved in an accident during the commission of a crime, administrative violation, or breach of traffic regulations, Roadside Assistance will not provide service. When the vehicle is not accessible to be towed, all maneuvers required to access it will be at the owner's expense.

If the vehicle is in another city outside of your residence, Roadside Assistance is limited to moving the vehicle to the nearest dealer. If you would like the vehicle moved to a different dealer, you will be asked to cover the difference in cost at the time of the move.

If the vehicle cannot be received by the nearest GMC dealer due to scheduling conflicts, the vehicle will be taken to a safe place where it will remain for up to 48 hours until it can be taken to the dealer. If the storage costs exceed the amount authorized, the owner is responsible to pay the difference at the time of service. Contact Roadside Assistance for more information on authorized amounts.

- **\*Trip Interruption:** This service is provided if you are prevented from further usage of your vehicle while traveling and it is not possible for the nearest GMC dealership to repair the vehicle the same day, requiring the vehicle to stay at the dealership for a night or more. If this happens, in addition to the previously listed services and prior to confirmation by the dealership, you are entitled to choose one of the following

alternatives, within the limits of existing Roadside Assistance program guidelines. If the costs exceed the amount authorized for these services, you must pay the difference at the time of service.

Roadside Assistance will coordinate hotel accommodations for all vehicle travelers for up to two nights.

A rental car will be provided for up to two days and the vehicle must be returned to its original destination, excluding vehicles with a carrying capacity greater than 3.5 tons.

Complimentary Transportation: If you prefer to continue your trip to the intended destination or return to your place of residence, and the trip requires more than eight hours driving on the road, transportation for the driver and passengers by first class bus or coach commercial airline will be provided to a

location chosen by Roadside Assistance, depending on availability at the chosen destination. Restrictions apply based on vehicle specifications.

If you are on the road, taxi service to the nearest bus station or airport will be provided.

- **\*Complimentary Transportation for Vehicle Pick Up:** Transportation to pick up your vehicle after repairs are complete. Once the dealer has reported that the vehicle has been repaired, Roadside Assistance will provide bus or commercial airline one-way service (subject to availability) for the person designated by you to collect your vehicle at the dealership's location if you or the designated person are not in the same town or city as the dealership.

## 13-10 Customer Information

---

\*These services are not provided for U.S. or Canada residents. All services provided in the U.S. and Canada are at the owner's expense and will be reimbursed by Roadside Assistance.

### Services Not Included in Roadside Assistance

Roadside Assistance does not cover or reimburse services for the following:

- Events caused by fraud or bad faith by the driver.
- Vehicle immobilization situations due to a major force or unforeseen circumstances, such as natural phenomena of an extraordinary nature, earthquakes, volcanic eruptions, and other cyclonic storms.
- Vehicle immobilization situations arising from car accidents caused by the driver of the vehicle or third parties. This means any occurrence that

causes physical injury to the occupants and/or the vehicle caused by external forces.

- Acts of terrorism, riot or uproar, armed forces or police actions which prevent timely delivery of assistance services.
- Food service, beverages, telephone calls, or other extra costs. Accommodation costs apply only to Mexico per the terms and conditions of the Roadside Assistance program.
- Any damage to the vehicle without intent, derived from the services provided.
- Cost of towing a trailer when choosing a GMC dealer that is nearest to the temporary storage facility for the disabled vehicle.
- Cost of all maneuvers required to access the vehicle when it is not available to be towed.
- Cost of fuel provided.

Routine vehicle repair costs are not covered by the Roadside Assistance program. For more information, see your new vehicle warranty.

### Contacting Roadside Assistance

Roadside Assistance services are of no cost to you and available 24 hours a day, 365 days a year. Costs are only incurred in situations that exceed the limits of the program, some of which are listed previously in this section.

To contact Roadside Assistance by phone, use the following numbers:

#### Mexico

01-800-466-0801

#### United States

1-866-466-8902

#### Canada

1-800-268-6800

#### E-mail

asistencia.GMC@gm.com

*GMC reserves the right to make any changes or discontinue the Roadside Assistance program at any time without notification.*

## Roadside Assistance Program (U.S. and Canada)

For U.S.-purchased vehicles, call 1-888-881-3302; (Text Telephone (TTY): 1-888-889-2438).

For Canadian-purchased vehicles, call 1-800-268-6800.

Service is available 24 hours a day, 365 days a year.

### Calling for Assistance

When calling Roadside Assistance, have the following information ready:

- Your name, home address, and home telephone number
- Telephone number of your location
- Location of the vehicle

- Model, year, color, and license plate number of the vehicle
- Odometer reading, Vehicle Identification Number (VIN), and delivery date of the vehicle
- Description of the problem

### Coverage

Services are provided up to 5 years/160 000 km (100,000 mi), whichever comes first.

In the U.S., anyone driving the vehicle is covered. In Canada, a person driving the vehicle without permission from the owner is not covered.

Roadside Assistance is not a part of the New Vehicle Limited Warranty. GMC and General Motors of Canada Limited reserve the right to make any changes or discontinue the Roadside Assistance program at any time without notification.

GMC and General Motors of Canada Limited reserve the right to limit services or payment to an owner or driver if they decide the

claims are made too often, or the same type of claim is made many times.

### Services Provided

- **Emergency Fuel Delivery:** Delivery of enough fuel for the vehicle to get to the nearest service station.
- **Lock-Out Service:** Service to unlock the vehicle if you are locked out. A remote unlock may be available if you have OnStar<sup>®</sup>. For security reasons, the driver must present identification before this service is given.
- **Emergency Tow From a Public Road or Highway:** Tow to the nearest GMC dealer for warranty service, or if the vehicle was in a crash and cannot be driven. Assistance is also given when the vehicle is stuck in the sand, mud, or snow.

## 13-12 Customer Information

---

- **Flat Tire Change:** Service to change a flat tire with the spare tire. The spare tire, if equipped, must be in good condition and properly inflated. It is the owner's responsibility for the repair or replacement of the tire if it is not covered by the warranty.
- **Battery Jump Start:** Service to jump start a dead battery.
- **Trip Interruption Benefits and Assistance:** If your trip is interrupted due to a warranty failure, incidental expenses may be reimbursed during the 5 years/(160 000 km) 100,000 mi Powertrain warranty period. Items considered are hotel, meals, and rental car.

### Services Not Included in Roadside Assistance

- Impound towing caused by violation of any laws.
- Legal fines.

- Mounting, dismounting, or changing of snow tires, chains, or other traction devices.
- Towing or services for vehicles driven on a non-public road or highway.

### Services Specific to Canadian-Purchased Vehicles

- **Fuel Delivery:** Reimbursement is approximately \$5 Canadian. Diesel fuel delivery may be restricted. Propane and other fuels are not provided through this service.
- **Lock-Out Service:** Vehicle registration is required.
- **Trip Interruption Benefits and Assistance:** Must be over 250 kilometres from where your trip was started to qualify. General Motors of Canada Limited requires pre-authorization, original detailed receipts, and a copy of the repair orders. Once authorization has been received,

the Roadside Assistance advisor will help to make arrangements and explain how to receive payment.

- **Alternative Service:** If assistance cannot be provided right away, the Roadside Assistance advisor may give permission to get local emergency road service. You will receive payment, up to \$100, after sending the original receipt to Roadside Assistance. Mechanical failures may be covered, however any cost for parts and labor for repairs not covered by the warranty are the owner responsibility.

### Scheduling Service Appointments (U.S. and Canada)

When the vehicle requires warranty service, contact your dealer and request an appointment. By scheduling a service appointment and advising the service consultant



of your transportation needs, your dealer can help minimize your inconvenience.

If the vehicle cannot be scheduled into the service department immediately, keep driving it until it can be scheduled for service, unless, of course, the problem is safety related. If it is, please call your dealership, let them know this, and ask for instructions.

If your dealer requests you to bring the vehicle for service, you are urged to do so as early in the work day as possible to allow for same-day repair.

## **Courtesy Transportation Program (U.S. and Canada)**

To enhance your ownership experience, we and our participating dealers are proud to offer Courtesy Transportation, a customer support program for vehicles with the Bumper-to-Bumper (Base Warranty

Coverage period in Canada), extended powertrain, and/or hybrid-specific warranties in both the U.S. and Canada.

Several Courtesy Transportation options are available to assist in reducing inconvenience when warranty repairs are required.

Courtesy Transportation is not a part of the New Vehicle Limited Warranty. A separate booklet entitled "Limited Warranty and Owner Assistance Information" furnished with each new vehicle provides detailed warranty coverage information.

### **Transportation Options**

Warranty service can generally be completed while you wait. However, if you are unable to wait, GM helps to minimize inconvenience by providing several transportation options. Depending on the circumstances, your dealer can offer one of the following:

### **Shuttle Service**

Shuttle service is the preferred means of offering Courtesy Transportation. Dealers may provide shuttle service to get you to your destination with minimal interruption of your daily schedule. This includes one-way or round-trip shuttle service within reasonable time and distance parameters of your dealer's area.

### **Public Transportation or Fuel Reimbursement**

If the vehicle requires overnight warranty repairs, and public transportation is used instead of your dealer's shuttle service, the expense must be supported by original receipts and can only be up to the maximum amount allowed by GM for shuttle service. In addition, for U.S. customers, should you arrange transportation through a friend or relative, limited reimbursement for reasonable fuel expenses may be available. Claim amounts should reflect actual costs and be supported by original

## 13-14 Customer Information

---

receipts. See your dealer for information regarding the allowance amounts for reimbursement of fuel or other transportation costs.

### **Courtesy Rental Vehicle**

Your dealer may arrange to provide you with a courtesy rental vehicle or reimburse you for a rental vehicle that you obtain if the vehicle is kept for an overnight warranty repair. Rental reimbursement will be limited and must be supported by original receipts. This requires that you sign and complete a rental agreement and meet state/provincial, local, and rental vehicle provider requirements. Requirements vary and may include minimum age requirements, insurance coverage, credit card, etc. You are responsible for fuel usage charges and may also be responsible for taxes, levies, usage fees, excessive mileage, or rental usage beyond the completion of the repair.

It may not be possible to provide a like vehicle as a courtesy rental.

### **Additional Program Information**

All program options, such as shuttle service, may not be available at every dealer. Please contact your dealer for specific information about availability. All Courtesy Transportation arrangements will be administered by appropriate dealer personnel.

*General Motors reserves the right to unilaterally modify, change, or discontinue Courtesy Transportation at any time and to resolve all questions of claim eligibility pursuant to the terms and conditions described herein at its sole discretion.*

### **Collision Damage Repair (U.S. and Canada)**

If the vehicle is involved in a collision and it is damaged, have the damage repaired by a qualified technician using the proper equipment and quality replacement parts. Poorly performed collision

repairs diminish the vehicle resale value, and safety performance can be compromised in subsequent collisions.

### **Collision Parts**

Genuine GM Collision parts are new parts made with the same materials and construction methods as the parts with which the vehicle was originally built. Genuine GM Collision parts are the best choice to ensure that the vehicle's designed appearance, durability, and safety are preserved. The use of Genuine GM parts can help maintain the GM New Vehicle Limited Warranty.

Recycled original equipment parts may also be used for repair. These parts are typically removed from vehicles that were total losses in prior crashes. In most cases, the parts being recycled are from undamaged sections of the vehicle. A recycled original equipment GM part may be an acceptable choice to maintain the vehicle's originally designed appearance and safety

performance; however, the history of these parts is not known. Such parts are not covered by the GM New Vehicle Limited Warranty, and any related failures are not covered by that warranty.

Aftermarket collision parts are also available. These are made by companies other than GM and may not have been tested for the vehicle. As a result, these parts may fit poorly, exhibit premature durability/corrosion problems, and may not perform properly in subsequent collisions. Aftermarket parts are not covered by the GM New Vehicle Limited Warranty, and any vehicle failure related to such parts is not covered by that warranty.

### Repair Facility

GM also recommends that you choose a collision repair facility that meets your needs before you ever need collision repairs. Your dealer may have a collision repair center with GM-trained technicians and state-of-the-art equipment, or be

able to recommend a collision repair center that has GM-trained technicians and comparable equipment.

### Insuring the Vehicle

Protect your investment in the GM vehicle with comprehensive and collision insurance coverage. There are significant differences in the quality of coverage afforded by various insurance policy terms. Many insurance policies provide reduced protection to the GM vehicle by limiting compensation for damage repairs through the use of aftermarket collision parts. Some insurance companies will not specify aftermarket collision parts. When purchasing insurance, we recommend that you ensure that the vehicle will be repaired with GM original equipment collision parts. If such insurance coverage is not available from your current insurance carrier, consider switching to another insurance carrier.

If the vehicle is leased, the leasing company may require you to have insurance that ensures repairs with Genuine GM Original Equipment Manufacturer (OEM) parts or Genuine Manufacturer replacement parts. Read the lease carefully, as you may be charged at the end of the lease for poor quality repairs.

### If a Crash Occurs

If there has been an injury, call emergency services for help. Do not leave the scene of a crash until all matters have been taken care of. Move the vehicle only if its position puts you in danger, or you are instructed to move it by a police officer.

Give only the necessary information to police and other parties involved in the crash.

For emergency towing see *Roadside Assistance Program (Mexico)* on page 13-7 or *Roadside Assistance Program (U.S. and Canada)* on page 13-11.

## 13-16 Customer Information

---

Gather the following information:

- Driver name, address, and telephone number.
- Driver license number.
- Owner name, address, and telephone number.
- Vehicle license plate number.
- Vehicle make, model, and model year.
- Vehicle Identification Number (VIN).
- Insurance company and policy number.
- General description of the damage to the other vehicle.

Choose a reputable repair facility that uses quality replacement parts. See “Collision Parts” earlier in this section.

If the airbag has inflated, see *What Will You See after an Airbag Inflates?* on page 3-26.

### **Managing the Vehicle Damage Repair Process**

In the event that the vehicle requires damage repairs, GM recommends that you take an active role in its repair. If you have a pre-determined repair facility of choice, take the vehicle there, or have it towed there. Specify to the facility that any required replacement collision parts be original equipment parts, either new Genuine GM parts or recycled original GM parts. Remember, recycled parts will not be covered by the GM vehicle warranty.

Insurance pays the bill for the repair, but you must live with the repair. Depending on your policy limits, your insurance company may initially value the repair using aftermarket parts. Discuss this with the repair professional, and insist on Genuine GM parts. Remember, if the vehicle is leased, you may be obligated to have the vehicle repaired with Genuine GM parts, even if your insurance coverage does not pay the full cost.

If another party's insurance company is paying for the repairs, you are not obligated to accept a repair valuation based on that insurance company's collision policy repair limits, as you have no contractual limits with that company. In such cases, you can have control of the repair and parts choices as long as the cost stays within reasonable limits.

### **Service Publications Ordering Information**

#### **Service Manuals**

Service Manuals have the diagnosis and repair information on the engines, transmission, axle, suspension, brakes, electrical, steering, body, etc.

#### **Service Bulletins**

Service Bulletins give additional technical service information needed to knowledgeably service General Motors cars and trucks.

Each bulletin contains instructions to assist in the diagnosis and service of the vehicle.

### **Owner Information**

Owner publications are written specifically for owners and intended to provide basic operational information about the vehicle. The Owner Manual includes the Maintenance Schedule for all models.

In-Portfolio: Includes a Portfolio, Owner Manual, and Warranty Booklet.

**RETAIL SELL PRICE:**  
\$35.00 (U.S.) plus handling and shipping fees.

Without Portfolio: Owner Manual only.

**RETAIL SELL PRICE:**  
\$25.00 (U.S.) plus handling and shipping fees.

### **Current and Past Models**

Technical Service Bulletins and Manuals are available for current and past model GM vehicles.

**ORDER TOLL FREE:**  
1-800-551-4123 Monday – Friday  
8:00 AM – 6:00 PM Eastern Time

For Credit Card Orders Only (VISA-MasterCard-Discover), visit Helm, Inc. at: [www.helminc.com](http://www.helminc.com).

Or write to:

Helm, Incorporated  
Attention: Customer Service  
47911 Halyard Drive  
Plymouth, MI 48170

Prices are subject to change without notice and without incurring obligation. Allow ample time for delivery.

All listed prices are quoted in U.S. funds. Make checks payable in U.S. funds.

## **Reporting Safety Defects**

### **Reporting Safety Defects to the United States Government**

If you believe that your vehicle has a defect which could cause a crash or could cause injury or death, you should immediately inform the National Highway Traffic Safety Administration (NHTSA) in addition to notifying General Motors.

If NHTSA receives similar complaints, it may open an investigation, and if it finds that a safety defect exists in a group of vehicles, it may order a recall and remedy campaign. However, NHTSA cannot become involved in individual problems between you, your dealer, or General Motors.

## 13-18 Customer Information

---

To contact NHTSA, you may call the Vehicle Safety Hotline toll-free at 1-888-327-4236 (TTY: 1-800-424-9153); go to <http://www.safercar.gov>; or write to:

Administrator, NHTSA  
1200 New Jersey Avenue, S.E.  
Washington, D.C. 20590

You can also obtain other information about motor vehicle safety from  
<http://www.safercar.gov>.

### **Reporting Safety Defects to the Canadian Government**

If you live in Canada, and you believe that the vehicle has a safety defect, notify Transport Canada immediately, and notify General Motors of Canada Limited. Call Transport Canada at 1-800-333-0510 or write to:

Transport Canada  
Road Safety Branch  
80 rue Noel  
Gatineau, QC J8Z 0A1

### **Reporting Safety Defects to General Motors**

In addition to notifying NHTSA (or Transport Canada) in a situation like this, please notify General Motors.

Call 1-800-GMC-8782  
(1-800-462-8782), or write:

GMC Customer Assistance Center  
P.O. Box 33172  
Detroit, MI 48232-5172

In Canada, call 1-800-263-3777  
(English) or 1-800-263-7854  
(French), or write:

General Motors of Canada Limited  
Customer Care Centre, Mail Code:  
CA1-163-005  
1908 Colonel Sam Drive  
Oshawa, Ontario L1H 8P7

## Vehicle Data Recording and Privacy

The vehicle has a number of computers that record information about the vehicle's performance and how it is driven. For example, the vehicle uses computer modules to monitor and control engine and transmission performance, to monitor the conditions for airbag deployment and deploy them in a crash, and, if equipped, to provide antilock braking to help the driver control the vehicle. These modules may store data to help the dealer technician service the vehicle. Some modules may also store data about how the vehicle is operated, such as rate of fuel consumption or average speed. These modules may retain personal preferences, such as radio presets, seat positions, and temperature settings.

## Event Data Recorders

This vehicle is equipped with an event data recorder (EDR). The main purpose of an EDR is to record, in certain crash or near crash-like situations, such as an air bag deployment or hitting a road obstacle, data that will assist in understanding how a vehicle's systems performed. The EDR is designed to record data related to vehicle dynamics and safety systems for a short period of time, typically 30 seconds or less. The EDR in this vehicle is designed to record such data as:

- How various systems in your vehicle were operating;
- Whether or not the driver and passenger safety belts were buckled/fastened;
- How far (if at all) the driver was depressing the accelerator and/or brake pedal; and,
- How fast the vehicle was traveling.

These data can help provide a better understanding of the circumstances in which crashes and injuries occur. NOTE: EDR data are recorded by your vehicle only if a non-trivial crash situation occurs; no data are recorded by the EDR under normal driving conditions and no personal data (e.g., name, gender, age, and crash location) are recorded. However, other parties, such as law enforcement, could combine the EDR data with the type of personally identifying data routinely acquired during a crash investigation.

To read data recorded by an EDR, special equipment is required, and access to the vehicle or the EDR is needed. In addition to the vehicle manufacturer, other parties, such as law enforcement, that have the special equipment, can read the information if they have access to the vehicle or the EDR.

GM will not access this data or share it with others except: with the consent of the vehicle owner or,

if the vehicle is leased, with the consent of the lessee; in response to an official request by police or similar government office; as part of GM's defense of litigation through the discovery process; or, as required by law. Data that GM collects or receives may also be used for GM research needs or may be made available to others for research purposes, where a need is shown and the data is not tied to a specific vehicle or vehicle owner.

### **OnStar®**

If the vehicle is equipped with OnStar® and has an active subscription, additional data may be collected through the OnStar system. This includes information about the vehicle's operation; about collisions involving the vehicle; the use of the vehicle and its features; and, in certain situations, the location and approximate GPS speed of the vehicle. Refer to the

OnStar Terms and Conditions and Privacy Statement on the OnStar website.

### **Navigation System**

If the vehicle is equipped with a navigation system, use of the system may result in the storage of destinations, addresses, telephone numbers, and other trip information. See the navigation manual for information on stored data and for deletion instructions.

### **Radio Frequency Identification (RFID)**

RFID technology is used in some vehicles for functions such as tire pressure monitoring and ignition system security, as well as in connection with conveniences such as Remote Keyless Entry (RKE) transmitters for remote door locking/unlocking and starting, and in-vehicle transmitters for garage door openers. RFID technology in GM vehicles does not use or record

personal information or link with any other GM system containing personal information.

### **Radio Frequency Statement**

This vehicle has systems that operate on a radio frequency that comply with Part 15 of the Federal Communications Commission (FCC) rules and with Industry Canada Standards RSS-GEN/210/220/310.

Operation is subject to the following two conditions:

1. The device may not cause harmful interference.
2. The device must accept any interference received, including interference that may cause undesired operation of the device.

Changes or modifications to any of these systems by other than an authorized service facility could void authorization to use this equipment.



# OnStar

## OnStar Overview

OnStar Overview ..... 14-1

## OnStar Services

Emergency ..... 14-2  
 Security ..... 14-2  
 Navigation ..... 14-2  
 Connections ..... 14-3  
 Diagnostics ..... 14-5

## OnStar Additional Information

OnStar Additional Information ..... 14-5

## OnStar Overview



If equipped, this vehicle has a comprehensive, in-vehicle system that can connect to a live Advisor for Emergency, Security, Navigation, Connection, and Diagnostic Services.

The OnStar system status light is next to the OnStar buttons. If the status light is:

- Solid Green: System is ready.
- Flashing Green: On a call.
- Red: Indicates a problem.

Press  or call 1-888-4ONSTAR (1-888-466-7827) to speak to an Advisor.

Press  to:

- Make a call, end a call, or answer an incoming call.
- Give OnStar Hands-Free Calling voice commands.
- Give OnStar Turn-by-Turn Navigation voice commands. Requires the available Directions and Connections service plan.

Press  to connect to a live Advisor to:

- Verify account information or update contact information.
- Get driving directions. Requires the available Directions and Connections service plan.
- Receive On-Demand Diagnostics for a check of the vehicle's key operating systems.
- Receive Roadside Assistance.

Press the OnStar Emergency button  to get a priority connection to an Emergency Advisor available 24/7 to:

- Get help for an emergency.
- Be a Good Samaritan or respond to an AMBER Alert.
- Get crisis assistance and evacuation routes.

## OnStar Services

### Emergency

With Automatic Crash Response, the built-in system can automatically connect to help in most crashes, even if help cannot be requested.

Press  to connect to an Emergency Advisor. GPS technology is used to identify the vehicle location and can provide critical information to emergency personnel. The Advisor is also trained to offer critical assistance in emergency situations before first responders arrive.

### Security

OnStar provides services like Stolen Vehicle Assistance, Remote Ignition Block, and Roadside Assistance, if the vehicle is equipped with these services. OnStar can unlock the vehicle doors remotely, if it is

equipped with automatic door locks, and can help police locate the vehicle if it is stolen.

### Navigation

OnStar navigation requires the Directions and Connections service plan.

Press  to receive directions or have them sent to the vehicle navigation screen, if equipped. Destinations can also be forwarded to the vehicle from MapQuest.com. The OnStar mapping database is continuously updated. Visit [www.onstar.com](http://www.onstar.com) for coverage maps.

### Turn-by-Turn Navigation

1. Press  to connect to a live Advisor.
2. Request directions.
3. Directions are downloaded to the vehicle.
4. Follow the voice-guided commands.

## Using Voice Commands During a Planned Route

### Cancel Route

1. Press . System responds: "OnStar ready," then a tone. Say "Cancel route." System responds: "Do you want to cancel directions?"
2. Say "Yes." System responds: "OK, request completed, thank you, goodbye."

### Route Preview

1. Press . System responds: "OnStar ready," then a tone.
2. Say "Route preview." System responds with the next three maneuvers.
3. Say "Goodbye." Exits voice commands.

### Repeat

1. Press . System responds: "OnStar ready," then a tone.

2. Say "Repeat." System responds with the last direction given, then responds with "OnStar ready," then a tone.
3. Say "Goodbye." Exits voice commands.

### Get My Destination

1. Press . System responds: "OnStar ready," then a tone.
2. Say "Get my destination." System responds with address and the distance to the destination, then responds with "OnStar ready," then a tone.
3. Say "Goodbye." Exits voice commands.

### Other Navigation Services Available from OnStar

**OnStar eNav:** Allows subscribers to send destinations from MapQuest.com to their Turn-by-Turn Navigation or screen-based navigation system. When ready, the directions will be downloaded to the vehicle.

**Destination Download:** Press , then request the Advisor to download directions to the navigation system in the vehicle. After the call ends, press the "Go" button on the navigation screen to begin driving directions.

Destinations can also be downloaded on the go. For information about eNav, Destination Download, and coverage maps visit [www.onstar.com](http://www.onstar.com).

### Connections

OnStar Hands-Free Calling allows calls to be made and received from the vehicle. The vehicle can also be controlled from a cell phone through the OnStar RemoteLink mobile app. See [www.onstar.com](http://www.onstar.com) for coverage maps.

### Hands-Free Calling

1. Press . System responds: "OnStar ready."

## 14-4 OnStar

---

2. Say "Call." System responds: "Please say the name or number to call."
3. Say the entire number without pausing, including a "1" and the area code. System responds: "OK calling."

### Calling 911 Emergency

1. Press . The system responds "OnStar Ready," followed by a tone.
2. Say "Call." The system responds "Please say the name or number to call."
3. Say "911" without pausing. The system responds "911."
4. Say "Call." The system responds "OK, dialing 911."

### Retrieve My Number

1. Press . System responds: "OnStar ready."
2. Say "My number." System responds: "Your OnStar Hands-Free Calling number is."

### End a Call

Press . System responds: "Call ended."

### Store a Name Tag for Speed Dialing

1. Press . System responds: "OnStar ready."
2. Say "Store." System responds: "Please say the number you would like to store."
3. Say the entire number without pausing. System responds: "Please say the name tag."
4. Pick a name tag. System responds: "About to store <name tag>. Does that sound OK?"
5. Say "Yes" or say "No" to try again. System responds: "OK, storing <name tag>."

### Place a Call Using a Stored Number

1. Press . System responds: "OnStar ready."
2. Say "Call <name tag>." System responds: "OK, calling <name tag>."

### Verify Minutes and Expiration

Press  and say "Minutes" then "Verify" to check how many minutes remain and their expiration date.

### OnStar Mobile App

Download the OnStar RemoteLink mobile app to your iPhone, Android, or BlackBerry smartphone to check vehicle fuel level, oil life, or tire pressure; to start the vehicle (if equipped) or unlock it; or to connect to an OnStar Advisor. For OnStar RemoteLink information and compatibility, see [www.onstar.com](http://www.onstar.com).

## Diagnostics

OnStar Vehicle Diagnostics will perform a vehicle check every month. It will check the engine, transmission, antilock brakes, and major vehicle systems. It also checks the tire pressures, if the vehicle is equipped with the Tire Pressure Monitoring System. If a diagnostics check is needed between e-mails, press **On**, and an Advisor can run a check.

## OnStar Additional Information

### Transferring Service

Press **On** to request account transfer eligibility information. The Advisor can assist in canceling or removing account information. If OnStar receives information that vehicle ownership has changed, OnStar may send a voice message to the vehicle, requesting updated account information.

### Reactivation for Subsequent Owners

Press **On** and follow the prompts to speak to an Advisor as soon as possible after acquiring the vehicle. The Advisor will update vehicle records and will explain the OnStar service offers and options available.

### How OnStar Service Works

Automatic Crash Response, Emergency Services, Crisis Assist, Stolen Vehicle Assistance, Vehicle

Diagnostics, Remote Door Unlock, Roadside Assistance, Turn-by-Turn Navigation, and Hands-Free Calling are available on most vehicles. Not all OnStar services are available everywhere or on all vehicles. For more information, a full description of OnStar services, system limitations, and OnStar terms and conditions, see [www.onstar.com](http://www.onstar.com) (U.S.) or [www.onstar.ca](http://www.onstar.ca) (Canada); contact OnStar at 1-888-4ONSTAR (1-888-466-7827) or TTY 1-877-248-2080; or press **On** to speak with an Advisor. OnStar services require a vehicle electrical system, wireless service, and GPS satellite technologies to be available and operating for features to function properly. These systems may not operate if the battery is discharged or disconnected.

OnStar service cannot work unless your vehicle is in a place where OnStar has an agreement with a wireless service provider for service in that area, and the wireless service provider has coverage,

network capacity, reception, and technology compatible with OnStar service. Service involving location information about the vehicle cannot work unless GPS signals are available, unobstructed, and compatible with the OnStar hardware. OnStar service may not work if the OnStar equipment is not properly installed or it has not been properly maintained. If equipment or software is added, connected, or modified, OnStar service may not work. Other problems beyond the control of OnStar may prevent service such as hills, tall buildings, tunnels, weather, electrical system design and architecture of the vehicle, damage to the vehicle in a crash, or wireless phone network congestion or jamming.

See *Radio Frequency Statement on page 13-20* for information regarding Part 15 of the Federal Communications Commission (FCC) rules and Industry Canada Standards RSS-GEN/210/220/310.

### Services for People with Disabilities

Advisors provide services to help subscribers with physical disabilities and medical conditions.

Press  for help with:

- Locating a gas station with an attendant to pump gas.
- Finding a hotel, restaurant, etc., that meets accessibility needs.
- Providing directions to the closest hospital or pharmacy in urgent situations.

### TTY Users

OnStar has the ability to communicate to the deaf, hard-of-hearing, or speech-impaired customers while in the vehicle. The available dealer-installed TTY system can provide in-vehicle access to all of the OnStar services, except Virtual Advisor and OnStar Turn-by-Turn Navigation.

### OnStar.com

The website provides access to account information, manages the OnStar subscription, and allows viewing of videos of each service. Get subscription plan pricing and sign up for OnStar Vehicle Diagnostics. Click on the “My Account” tab on the home page.

### OnStar Personal Identification Number (PIN)

A PIN is needed to access some of the OnStar services, like Remote Door Unlock and Stolen Vehicle Assistance. You will be prompted to change the PIN the first time when speaking with an Advisor. To change the OnStar PIN, call OnStar and provide the Advisor with the current number.

### Warranty

OnStar equipment may be warranted as part of the New Vehicle Limited Warranty. The

manufacturer of the vehicle furnishes detailed warranty information.

### Languages

The vehicle can be programmed to respond in French or Spanish. Press  and ask an Advisor. Advisors can speak French or Spanish.

### Potential Issues

Some OnStar services are disabled after five days. OnStar cannot perform Remote Door Unlock or Stolen Vehicle Assistance after the vehicle has been off continuously for five days. After five days, OnStar can contact Roadside Assistance and a locksmith to help gain access to the vehicle.

### Global Positioning System (GPS)

- Obstruction of the GPS can occur in a large city with tall buildings; in parking garages; around airports; in tunnels,

underpasses, or parking garages; or in an area with very dense trees. If GPS signals are not available, the OnStar system should still operate to call OnStar. However, OnStar could have difficulty identifying the exact location.

- In emergency situations, OnStar can use the last stored GPS location to send to emergency responders.
- A temporary loss of GPS can cause loss of the ability to send a Turn-by-Turn Navigation route. The Advisor may give a verbal route or may ask for a call back after the vehicle is driven into an open area.

### Cellular and GPS Antennas

Avoid placing items over or near the antenna to prevent blocking cellular and GPS signal reception. Cellular reception is required for OnStar to send remote signals to the vehicle.

### Unable to Connect to OnStar Message

If there is limited cellular coverage or the cellular network has reached maximum capacity, this message may come on. Press  to try the call again or try again after driving a few miles into another cellular area.

### Vehicle and Power Issues

OnStar services require a vehicle electrical system, wireless service, and GPS satellite technologies to be available and operating for features to function properly. These systems may not operate if the battery is discharged or disconnected.

### Add-on Electrical Equipment

The OnStar system is integrated into the electrical architecture of the vehicle. Do not add any electrical equipment. See *Add-On Electrical Equipment on page 9-101*. Added electrical equipment may interfere with the operation of the OnStar system and cause it to not operate.

**Privacy**

The complete OnStar Privacy Statement may be found at [www.onstar.com](http://www.onstar.com). Privacy-sensitive users of wireless communications are cautioned that the privacy of any information sent via wireless cellular communications cannot be assured. Third parties may unlawfully intercept or access transmissions and private communications without consent.



**A**

Accessories and  
Modifications ..... 10-3

Accessory Power ..... 9-27

Active Fuel Management® ..... 9-30

Add-On Electrical  
Equipment ..... 9-101

Adding a Snow Plow or  
Similar Equipment ..... 9-101

Additional Information  
OnStar® ..... 14-5

Adjustable Throttle and  
Brake Pedal ..... 9-23

Adjustments  
Lumbar, Front Seats ..... 3-4

Air Cleaner/Filter, Engine ..... 10-15

Air Vents ..... 8-10

Airbag System  
Check ..... 3-37  
How Does an Airbag  
Restrain? ..... 3-26  
Passenger Sensing  
System ..... 3-31  
What Makes an Airbag  
Inflate? ..... 3-26

Airbag System (cont'd)  
What Will You See after an  
Airbag Inflates? ..... 3-26  
When Should an Airbag  
Inflate? ..... 3-24  
Where Are the Airbags? ..... 3-22

Airbags  
Adding Equipment to the  
Vehicle ..... 3-35  
Light On-Off ..... 5-18  
On-Off Light ..... 5-18  
On-Off Switch ..... 3-28  
Passenger Status Indicator ..... 5-19  
Readiness Light ..... 5-17  
Servicing Airbag-Equipped  
Vehicles ..... 3-35  
System Check ..... 3-20

Alarm  
Vehicle Security ..... 2-10

AM-FM Radio ..... 7-10

Antenna  
Satellite Radio ..... 7-16

Antilock Brake  
System (ABS) ..... 9-50  
Warning Light ..... 5-24

Appearance Care  
Exterior ..... 10-91  
Interior ..... 10-94

Armrest Storage ..... 4-1

Ashtrays ..... 5-10

Assistance Program,  
Roadside ..... 13-7, 13-11

Audio Players ..... 7-17  
CD ..... 7-17  
CD/DVD ..... 7-23

Audio System  
Fixed Mast Antenna ..... 7-16  
Radio Reception ..... 7-15  
Rear Seat (RSA) ..... 7-47  
Theft-Deterrent Feature ..... 7-2

Automatic  
Door Locks ..... 2-7  
Headlamp System ..... 6-3  
Transmission ..... 9-32  
Transmission Fluid .. 10-10, 10-12

Automatic Transmission  
Manual Mode ..... 9-36  
Shift Lock Control  
Function Check ..... 10-32

Auxiliary	
Devices .....	7-33
Roof Mounted Lamp .....	6-6
Axle, Front .....	10-29
Axle, Rear .....	10-30

**B**

Battery .....	10-27
Jump Starting .....	10-82
Load Management .....	6-9
Power Protection .....	6-9
Voltage and Charging	
Messages .....	5-37
Blade Replacement, Wiper ...	10-33
Bluetooth .....	7-49
Brake	
Pedal and Adjustable	
Throttle .....	9-23
System Warning Light .....	5-23
Brakes .....	10-24
Antilock .....	9-50
Assist .....	9-52
Fluid .....	10-25
Parking .....	9-51
System Messages .....	5-38

Braking .....	9-3
Break-In, New Vehicle .....	9-23
Bulb Replacement .....	10-38
Center High-Mounted	
Stoplamp (CHMSL) and	
Cargo Lamp .....	10-37
Fog Lamps .....	6-6
Halogen Bulbs .....	10-34
Headlamp Aiming .....	10-34
Headlamps .....	10-34
Headlamps, Front Turn	
Signal, Sidemarker, and	
Parking Lamps .....	10-35
License Plate Lamps .....	10-37
Pick-up Box Identification	
and Fender Marker	
Lamps .....	10-35
Taillamps .....	10-36
Taillamps, Turn Signal,	
Stoplamps, and	
Back-up Lamps .....	10-36
Buying New Tires .....	10-65

**C**

Calibration .....	5-5
California	
Fuel Requirements .....	9-66
Perchlorate Materials	
Requirements .....	10-3
Warning .....	10-2
Camera, Rear Vision .....	9-60
Canadian Vehicle Owners .....	iii
Capacities and	
Specifications .....	12-2
Carbon Monoxide	
Engine Exhaust .....	9-31
Tailgate .....	2-9
Winter Driving .....	9-12
Cargo Lamp .....	6-7
Cautions, Danger, and	
Warnings .....	iv
CD Player .....	7-17
CD/DVD Player .....	7-23
Center Console Storage .....	4-2
Center High-Mounted	
Stoplamp (CHMSL) and	
Cargo Lamp .....	10-37
Center Seat .....	3-3
Chains, Tire .....	10-70

Charging System Light ..... 5-20

Check

  Engine Light ..... 5-21

  Ignition

    Transmission Lock ..... 10-32

Child Restraints

  Infants and Young

    Children ..... 3-40

  Lower Anchors and

    Tethers for Children ..... 3-45

  Older Children ..... 3-38

  Securing ..... 3-54, 3-56, 3-57

  Systems ..... 3-42

Cigarette Lighter ..... 5-9

Circuit Breakers ..... 10-39

Cleaning

  Exterior Care ..... 10-91

  Interior Care ..... 10-94

Climate Control Systems ... 8-1, 8-4

  Air Conditioning ..... 8-1, 8-4

  Dual Automatic ..... 8-5

  Heating ..... 8-1, 8-4

Clock ..... 5-7

Cluster, Instrument ..... 5-11

Collision Damage Repair ..... 13-14

Compass ..... 5-5

Connections

  OnStar® ..... 14-3

Control of a Vehicle ..... 9-3

Convex Mirrors ..... 2-13

Coolant

  Engine ..... 10-17

  Engine Temperature

    Gauge ..... 5-15

Cooling System ..... 10-16

  Engine Messages ..... 5-39

Courtesy Transportation

  Program ..... 13-13

Cruise Control ..... 9-56

  Light ..... 5-28

Cupholders ..... 4-1

Customer Assistance ..... 13-6

  Offices ..... 13-5

  Text Telephone (TTY)

    Users ..... 13-6

Customer Information

  Service Publications

    Ordering Information ..... 13-16

Customer Satisfaction

  Procedure ..... 13-2, 13-4

**D**

Damage Repair, Collision ..... 13-14

Danger, Warnings, and

  Cautions ..... iv

Data Recorders, Event ..... 13-19

Daytime Running

  Lamps (DRL) ..... 6-3

Defensive Driving ..... 9-3

Delayed Locking ..... 2-7

Devices

  Auxiliary ..... 7-33

Diagnostics

  OnStar® ..... 14-5

Distracted Driving ..... 9-2

Dome Lamps ..... 6-7

Door

  Ajar Messages ..... 5-38

  Delayed Locking ..... 2-7

  Locks ..... 2-6

  Power Locks ..... 2-7

  Rear Doors ..... 2-8

Drive Belt Routing, Engine ..... 12-6

Driver Information

  Center (DIC) ..... 5-28

## Driving

Characteristics and	
Towing Tips .....	9-71
Defensive .....	9-3
Drunk .....	9-3
For Better Fuel Economy .....	1-33
Highway Hypnosis .....	9-11
Hill and Mountain Roads .....	9-11
If the Vehicle is Stuck .....	9-14
Loss of Control .....	9-5
Off-Road .....	9-5
Off-Road Recovery .....	9-4
Vehicle Load Limits .....	9-15
Wet Roads .....	9-10
Winter .....	9-12
Dual Automatic Climate	
Control System .....	8-5
Dual Tire	
Rotation .....	10-63
DVD	
Rear Seat Entertainment	
System .....	7-38
DVD/CD Player .....	7-23

**E**

E85 Fuel .....	9-68
Electrical Equipment,	
Add-On .....	9-101
Electrical System	
Engine Compartment	
Fuse Block .....	10-39
Fuses and Circuit	
Breakers .....	10-39
Instrument Panel Fuse	
Block .....	10-43
Overload .....	10-38
Emergency	
OnStar® .....	14-2
Engine	
Air Cleaner/Filter .....	10-15
Check and Service Engine	
Soon Light .....	5-21
Compartment Overview .....	10-5
Coolant .....	10-17
Coolant Heater .....	9-28
Coolant Temperature	
Gauge .....	5-15

## Engine (cont'd)

Cooling System .....	10-16
Cooling System Messages .....	5-39
Drive Belt Routing .....	12-6
Exhaust .....	9-31
Fan .....	10-22
Oil Life System .....	10-9
Oil Messages .....	5-40
Oil Pressure Gauge .....	5-14
Overheated Protection	
Operating Mode .....	10-22
Overheating .....	10-20
Power Messages .....	5-40
Pressure Light .....	5-26
Running While Parked .....	9-32
Starting .....	9-25
Entry Lighting .....	6-8
Equipment, Towing .....	9-89
Event Data Recorders .....	13-19
Exit Lighting .....	6-8
Extender, Safety Belt .....	3-19
Exterior Lamp Controls .....	6-1
Exterior Lamps Off Reminder .....	6-2

**F**

Fan  
 Engine ..... 10-22  
 Fast Idle System ..... 9-27  
 Features  
 Memory ..... 1-12  
 Filter,  
 Engine Air Cleaner ..... 10-15  
 Flash-to-Pass ..... 6-3  
 Flashers, Hazard Warning ..... 6-5  
 Flat Tire ..... 10-70  
 Changing ..... 10-72  
 Floor Mats ..... 10-97  
 Fluid  
 Automatic  
 Transmission ..... 10-10, 10-12  
 Brakes ..... 10-25  
 Four-Wheel Drive  
 Transfer Case ..... 9-38  
 Power Steering ..... 10-23  
 Washer ..... 10-23  
 Fog Lamps  
 Bulb Replacement ..... 6-6  
 Folding Mirrors ..... 2-15

Four-Wheel Drive ..... 10-28, 9-38  
 Four-Wheel-Drive Light ..... 5-25  
 Front Axle ..... 10-29  
 Front Fog Lamp  
 Light ..... 5-28  
 Front Seats  
 Adjustment ..... 3-3  
 Heated and Ventilated ..... 3-8  
 Fuel ..... 9-65  
 Additives ..... 9-67  
 E85 (85% Ethanol) ..... 9-68  
 Economy Driving ..... 1-33  
 Filling a Portable Fuel  
 Container ..... 9-70  
 Filling the Tank ..... 9-68  
 Foreign Countries ..... 9-66  
 Gasoline Specifications ..... 9-66  
 Gauge ..... 5-13  
 Low Fuel Warning Light ..... 5-27  
 Management, Active ..... 9-30  
 Recommended ..... 9-66  
 Requirements, California ..... 9-66  
 System Messages ..... 5-41  
 Full-Size Spare Tire ..... 10-82

Fuses

Engine Compartment  
 Fuse Block ..... 10-39  
 Fuses and Circuit  
 Breakers ..... 10-39  
 Instrument Panel Fuse  
 Block ..... 10-43

**G**

Garage Door Opener ..... 5-54  
 Programming ..... 5-54  
 Gasoline  
 Specifications ..... 9-66  
 Gauges  
 Engine Coolant  
 Temperature ..... 5-15  
 Engine Oil Pressure ..... 5-14  
 Fuel ..... 5-13  
 Odometer ..... 5-12  
 Speedometer ..... 5-12  
 Tachometer ..... 5-12  
 Trip Odometer ..... 5-12  
 Voltmeter ..... 5-15  
 Warning Lights and  
 Indicators ..... 5-10

General Information	
Service and Maintenance	11-1
Towing	9-71
Vehicle Care	10-2
Glass Replacement	10-34
Glove Box	4-1
GM Mobility Reimbursement Program	13-7

## H

Halogen Bulbs	10-34
Hazard Warning Flashers	6-5
Head Restraints	3-2
Headlamps	
Aiming	10-34
Automatic	6-3
Bulb Replacement	10-34
Daytime Running Lamps (DRL)	6-3
Flash-to-Pass	6-3
Headlamps, Front Turn Signal, Sidemarkers, and Parking Lamps	10-35
High-Beam On Light	5-28
High/Low Beam Changer	6-2

Heated and Ventilated Front Seats	3-8
Heated Mirrors	2-16
Heater	
Engine Coolant	9-28
Heating and Air Conditioning	8-1, 8-4
High-Beam On Light	5-28
High-Speed Operation	10-56
Highway Hypnosis	9-11
Hill and Mountain Roads	9-11
Hill Start Assist (HSA)	9-52
Hood	10-4
Horn	5-4
How to Wear Safety Belts Properly	3-12

## I

Idle System	
Fast	9-27
Ignition Positions	9-24
Ignition Transmission Lock Check	10-32
Immobilizer	2-11
Infants and Young Children, Restraints	3-40

Infotainment	7-1
Instrument Cluster	5-11
Instrument Panel Storage Area	4-1
Introduction	iii

## J

Jump Starting	10-82
---------------	-------

## K

Key and Lock Messages	5-41
Keyless Entry Remote (RKE) System	2-2
Keys	2-1

## L

Labeling, Tire Sidewall	10-48
Lamps	
Auxiliary Roof Mounted Lamp	6-6
Cargo	6-7
Daytime Running (DRL)	6-3
Dome	6-7
Exterior Controls	6-1

Lamps (cont'd)	Lights (cont'd)	Low Fuel Warning Light . . . . .	5-27
Exterior Lamps Off	Brake System Warning . . . . .	Lower Anchors and Tethers	
Reminder . . . . .	Charging System . . . . .	for Children (LATCH	
License Plate . . . . .	Cruise Control . . . . .	System) . . . . .	3-45
Malfunction Indicator . . . . .	Engine Oil Pressure . . . . .	Lumbar Adjustment . . . . .	3-4
Messages . . . . .	Flash-to-Pass . . . . .	Front Seats . . . . .	3-4
Pick-up Box Identification	Four-Wheel-Drive . . . . .		
and Fender Marker . . . . .	Front Fog Lamp . . . . .		
Reading . . . . .	High-Beam On . . . . .		
Taillamps . . . . .	High/Low Beam Changer . . . . .		
Lap Belt . . . . .	Low Fuel Warning . . . . .		
Lap-Shoulder Belt . . . . .	Safety Belt Reminders . . . . .		
LATCH System	Security . . . . .		
Replacing Parts after a	StabiliTrak <sup>®</sup> OFF . . . . .		
Crash . . . . .	Tire Pressure . . . . .		
LATCH, Lower Anchors and	Tow/Haul Mode . . . . .		
Tethers for Children . . . . .	Traction Control System		
Lighter, Cigarette . . . . .	(TCS)/StabiliTrak <sup>®</sup> . . . . .		
Lighting	Locking Rear Axle . . . . .		
Entry . . . . .	Locks		
Exit . . . . .	Automatic Door . . . . .		
Illumination Control . . . . .	Delayed Locking . . . . .		
Lights	Door . . . . .		
Airbag On-Off . . . . .	Lockout Protection . . . . .		
Airbag Readiness . . . . .	Power Door . . . . .		
Antilock Brake System	Safety . . . . .		
(ABS) Warning . . . . .	Loss of Control . . . . .		

## M

Maintenance	
Records . . . . .	11-16
Maintenance Schedule	
Recommended Fluids	
and Lubricants . . . . .	11-12
Transfer Case . . . . .	9-38
Malfunction Indicator Lamp . . . . .	5-21
Manual Mirrors . . . . .	2-13
Manual Mode . . . . .	9-36
Manual Windows . . . . .	2-18
Memory Features . . . . .	1-12
Memory Seats . . . . .	3-6
Messages	
Airbag System . . . . .	5-43
Battery Voltage and	
Charging . . . . .	5-37
Brake System . . . . .	5-38
Door Ajar . . . . .	5-38

**Messages (cont'd)**

Engine Cooling System .....	5-39
Engine Oil .....	5-40
Engine Power .....	5-40
Fuel System .....	5-41
Key and Lock .....	5-41
Lamp .....	5-41
Object Detection System .....	5-41
Ride Control System .....	5-42
Security .....	5-43
Starting the Vehicle .....	5-43
Tire .....	5-43
Transmission .....	5-44
Vehicle .....	5-37
Vehicle Reminder .....	5-45
Washer Fluid .....	5-46

**Mirrors**

Automatic Dimming	
Rearview .....	2-17
Convex .....	2-13
Folding .....	2-15
Heated .....	2-16
Manual .....	2-13

**Mirrors (cont'd)**

Manual Rearview .....	2-16
Park Tilt .....	2-16
Power .....	2-14
Trailer Tow .....	2-13
Monitor System, Tire	
Pressure .....	10-57

**N****Navigation**

OnStar® .....	14-2
Vehicle Data Recording	
and Privacy .....	13-20
New Vehicle Break-In .....	9-23
Noise Control System .....	10-31

**O****Object Detection System**

Messages .....	5-41
Odometer .....	5-12
Trip .....	5-12
Off-Road .....	9-5
Driving .....	9-5
Recovery .....	9-4

**Oil**

Engine .....	10-6
Engine Oil Life System .....	10-9
Engine Oil Pressure	
Gauge .....	5-14
Messages .....	5-40
Pressure Light .....	5-26
Older Children, Restraints .....	3-38
Online Owner Center .....	13-6
OnStar®	
System, In Brief .....	1-33
OnStar® Additional	
Information .....	14-5
OnStar® Connections .....	14-3
OnStar® Diagnostics .....	14-5
OnStar® Emergency .....	14-2
OnStar® Navigation .....	14-2
OnStar® Overview .....	14-1
OnStar® Security .....	14-2
Operation, Infotainment	
System .....	7-7
Ordering	
Service Publications .....	13-16
Outlets	
Power .....	5-9



Overheated Engine  
 Protection  
 Operating Mode ..... 10-22  
 Overheating, Engine ..... 10-20  
 Overview,  
 Infotainment  
 System ..... 7-3, 7-4, 7-6

**P**

Park  
 Shifting Into ..... 9-28  
 Shifting Out of ..... 9-30  
 Tilt Mirrors ..... 2-16  
 Parking  
 Assist, Ultrasonic ..... 9-59  
 Brake ..... 9-51  
 Brake and P (Park)  
 Mechanism Check ..... 10-33  
 Over Things That Burn ..... 9-30  
 Passenger Airbag Status  
 Indicator ..... 5-19  
 Passenger Sensing System ... 3-31  
 Perchlorate Materials  
 Requirements, California ..... 10-3  
 Personalization  
 Vehicle ..... 5-46

Phone  
 Bluetooth ..... 7-49  
 Pick-up Box Identification  
 and Fender Marker  
 Lamps ..... 10-35  
 Pickup Conversion to  
 Chassis Cab ..... 9-104  
 Power  
 Door Locks ..... 2-7  
 Mirrors ..... 2-14  
 Outlets ..... 5-9  
 Protection, Battery ..... 6-9  
 Retained Accessory (RAP) ... 9-27  
 Seat Adjustment ..... 3-4  
 Steering Fluid ..... 10-23  
 Windows ..... 2-18  
 Pregnancy, Using Safety  
 Belts ..... 3-18  
 Privacy  
 Radio Frequency  
 Identification (RFID) ..... 13-20  
 Program  
 Courtesy Transportation .... 13-13  
 Proposition 65 Warning,  
 California ..... 10-2

**R**

Radio Frequency  
 Identification (RFID) ..... 13-20  
 Statement ..... 13-20  
 Radios  
 AM-FM Radio ..... 7-10  
 CD/DVD Player ..... 7-23  
 Reception ..... 7-15  
 Satellite ..... 7-12  
 Reading Lamps ..... 6-8  
 Rear Axle ..... 10-30  
 Locking ..... 9-55  
 Rear Doors ..... 2-8  
 Rear Seat Audio (RSA)  
 System ..... 7-47  
 Rear Seat Entertainment  
 System ..... 7-38  
 Rear Seat Audio (RSA) ..... 7-47  
 Rear Seats ..... 3-9, 3-10  
 Rear Vision Camera (RVC) .... 9-60  
 Rear Windows ..... 2-19  
 Rearview Mirrors ..... 2-16  
 Automatic Dimming ..... 2-17  
 Reclining Seatbacks ..... 3-5  
 Recommended  
 Fuel ..... 9-66

Recommended Fluids and  
Lubricants ..... 11-12

Records  
Maintenance ..... 11-16

Recreational Vehicle  
Towing ..... 10-87

Reimbursement Program,  
GM Mobility ..... 13-7

Remote Keyless Entry (RKE)  
System ..... 2-2

Remote Vehicle Start ..... 2-4

Replacement  
Glass ..... 10-34

Replacement Bulbs ..... 10-38

Replacement Parts  
Airbags ..... 3-37  
Maintenance ..... 11-14

Replacing Airbag System ..... 3-37

Replacing LATCH System  
Parts after a Crash ..... 3-54

Replacing Safety Belt  
System Parts after a Crash ... 3-20

Reporting Safety Defects  
Canadian Government ..... 13-18  
General Motors ..... 13-18  
U.S. Government ..... 13-17

Restraints  
Where to Put ..... 3-44

Retained Accessory  
Power (RAP) ..... 9-27

Ride Control Systems  
Messages ..... 5-42

Roads  
Driving, Wet ..... 9-10

Roadside Assistance  
Program ..... 13-7, 13-11

Roof  
Sunroof ..... 2-20, 2-21

Rotation, Tires ..... 10-61

Routing, Engine Drive Belt ..... 12-6

Running the Vehicle While  
Parked ..... 9-32

## **S**

Safety Belts ..... 3-11  
Care ..... 3-19  
Extender ..... 3-19  
How to Wear Safety Belts  
Properly ..... 3-12  
Lap Belt ..... 3-18  
Lap-Shoulder Belt ..... 3-13

Safety Belts (cont'd)  
Reminders ..... 5-16  
Replacing after a Crash ..... 3-20  
Use During Pregnancy ..... 3-18

Safety Defects Reporting  
Canadian Government ..... 13-18  
General Motors ..... 13-18  
U.S. Government ..... 13-17

Safety Locks ..... 2-8

Safety System Check ..... 3-19

Satellite Radio ..... 7-12

Scheduling Appointments ..... 13-12

Seats  
Adjustment, Front ..... 3-3  
Center Seat ..... 3-3  
Head Restraints ..... 3-2  
Heated and Ventilated Front ... 3-8  
Lumbar Adjustment, Front ..... 3-4  
Memory ..... 3-6  
Power Adjustment, Front ..... 3-4  
Rear ..... 3-9, 3-10  
Reclining Seatbacks ..... 3-5

Securing Child  
Restraints ..... 3-54, 3-56, 3-57

Security  
 Light ..... 5-27  
 Messages ..... 5-43  
 OnStar® ..... 14-2  
 Vehicle ..... 2-10  
 Vehicle Alarm ..... 2-10

Service  
 Accessories and  
     Modifications ..... 10-3  
 Doing Your Own Work ..... 10-3  
 Engine Soon Light ..... 5-21  
 Maintenance Records ..... 11-16  
 Maintenance, General  
     Information ..... 11-1  
 Parts Identification Label ..... 12-1  
 Publications Ordering  
     Information ..... 13-16  
 Scheduling Appointments ... 13-12

Servicing the Airbag ..... 3-35

Shift Lock Control Function  
 Check, Automatic  
     Transmission ..... 10-32

Shifting  
 Into Park ..... 9-28  
 Out of Park ..... 9-30

Signals, Turn and  
     Lane-Change ..... 6-5

Snow Plow ..... 9-101

Specifications and  
     Capacities ..... 12-2

Speedometer ..... 5-12

StabiliTrak  
     OFF Light ..... 5-25  
     System ..... 9-53

Start Assist, Hills ..... 9-52

Start Vehicle, Remote ..... 2-4

Starter Switch Check ..... 10-32

Starting the Engine ..... 9-25

Starting the Vehicle  
     Messages ..... 5-43

Steering ..... 9-4  
     Fluid, Power ..... 10-23  
     Wheel Adjustment ..... 5-2  
     Wheel Controls ..... 5-2

Stoplamps and Back-up Lamps  
     Bulb Replacement ..... 10-36

Storage Areas  
     Armrest ..... 4-1  
     Center Console ..... 4-2  
     Glove Box ..... 4-1  
     Instrument Panel ..... 4-1

Stuck Vehicle ..... 9-14

Sun Visors ..... 2-19

Sunroof ..... 2-20, 2-21

Switches  
     Airbag On-Off ..... 3-28

Symbols ..... iv

System  
     Infotainment ..... 7-1  
     Noise Control ..... 10-31

**T**

Tachometer ..... 5-12

Tailgate ..... 2-9

Taillamps ..... 10-36  
     Bulb Replacement ..... 10-36

Text Telephone (TTY) Users ... 13-6

Theft-Deterrent Systems ..... 2-11  
     Immobilizer ..... 2-11

Throttle, Adjustable ..... 9-23

Time ..... 5-7

Tires  
     Buying New Tires ..... 10-65  
     Chains ..... 10-70  
     Changing ..... 10-72  
     Designations ..... 10-51  
     Different Size ..... 10-66

Tires (cont'd)			
Dual Rotation .....	10-63	Towing	
Full-Size Spare .....	10-82	Driving Characteristics .....	9-71
If a Tire Goes Flat .....	10-70	Equipment .....	9-89
Inflation Monitor System ...	10-58	General Information .....	9-71
Inspection .....	10-61	Recreational Vehicle .....	10-87
Messages .....	5-43	Trailer .....	9-73
Pressure .....	10-56	Trailer Sway	
Pressure Light .....	5-26	Control (TSC) .....	9-100
Pressure Monitor System ...	10-57	Vehicle .....	10-87
Rotation .....	10-61	Traction	
Sidewall Labeling .....	10-48	Control System (TCS)/	
Terminology and		StabiliTrak® Light .....	5-26
Definitions .....	10-52	Trailer	
Uniform Tire Quality		Sway Control (TSC) .....	9-100
Grading .....	10-67	Tow Mirrors .....	2-13
Wheel Alignment and Tire		Towing .....	9-73
Balance .....	10-68	Transfer Case .....	9-38
Wheel Replacement .....	10-69	Transmission	
When It Is Time for New		Automatic .....	9-32
Tires .....	10-64	Fluid, Automatic .....	10-10, 10-12
Winter .....	10-48	Messages .....	5-44
Tow/Haul Mode .....	9-37	Transportation Program,	
Tow/Haul Mode Light .....	5-25	Courtesy .....	13-13
		Trip Odometer .....	5-12
		Truck-Camper Loading	
		Information .....	9-21
		Turn and Lane-Change	
		Signals .....	6-5
		Turn Signal	
		Bulb Replacement .....	10-36
		<b>U</b>	
		Ultrasonic Parking Assist .....	9-59
		Uniform Tire Quality	
		Grading .....	10-67
		Universal Remote System ...	5-54
		Operation .....	5-58
		Programming .....	5-54
		Using This Manual .....	iii
		<b>V</b>	
		Vehicle	
		Alarm System .....	2-10
		Canadian Owners .....	iii
		Control .....	9-3
		Identification	
		Number (VIN) .....	12-1
		Load Limits .....	9-15
		Messages .....	5-37
		Personalization .....	5-46
		Reminder Messages .....	5-45

Vehicle (cont'd)  
 Remote Start ..... 2-4  
 Security ..... 2-10  
 Towing ..... 10-87  
 Vehicle Care  
 Tire Pressure ..... 10-55  
 Ventilation, Air ..... 8-10  
 Visors ..... 2-19  
 Voltmeter Gauge ..... 5-15

**W**

Warning  
 Brake System Light ..... 5-23  
 Warning Lights, Gauges,  
 and Indicators ..... 5-10  
 Warnings ..... iv  
 Cautions and Danger ..... iv  
 Hazard Flashers ..... 6-5

Washer Fluid ..... 10-23  
 Messages ..... 5-46  
 Wheels  
 Alignment and Tire  
 Balance ..... 10-68  
 Different Size ..... 10-66  
 Replacement ..... 10-69  
 When It Is Time for New  
 Tires ..... 10-64  
 Where to Put the Restraint .... 3-44  
 Windows ..... 2-17  
 Manual ..... 2-18  
 Power ..... 2-18  
 Rear ..... 2-19  
 Windshield  
 Wiper/Washer ..... 5-4  
 Winter  
 Driving ..... 9-12  
 Winter Tires ..... 10-48  
 Wiper Blade Replacement .... 10-33

