



fordowner.com



ford.ca



The information contained in this publication was correct at the time of going to print. In the interest of continuous development, we reserve the right to change specifications, design or equipment at any time without notice or obligation. No part of this publication may be reproduced, transmitted, stored in a retrieval system or translated into any language in any form by any means without our written permission. Errors and omissions excepted.

© Ford Motor Company 2013

All rights reserved.

Part Number: 20130604200151

Table of Contents

Introduction

About This Supplement.....3

Instrument Cluster

Gauges.....7

Warning Lamps and Indicators.....7

Starting and Stopping the Engine

Starting a Diesel Engine.....9

Switching Off the Engine.....12

Engine Idle Shutdown.....12

Engine Block Heater.....13

Fuel and Refueling

Fuel Quality.....14

Selective Catalytic Reduction System.....20

Refueling.....28

Emission Control System.....29

Fuel Tank Selector Switch.....35

Brakes

General Information.....36

Towing

Towing a Trailer.....37

Roadside Emergencies

Fuel Shutoff.....38

Jump-Starting the Vehicle.....38

Maintenance

Under Hood Overview.....41

Engine Oil Check.....42

Engine Coolant Check.....44

Changing the Engine Air Filter.....49

Vehicle Care

Cleaning the Engine.....53

Cleaning the Exhaust.....53

Capacities and Specifications

Engine Specifications.....54

Motorcraft Parts.....54

Technical Specifications.....56

Scheduled Maintenance

General Maintenance Information.....58

Normal Scheduled Maintenance.....61

Special Operating Conditions Scheduled Maintenance.....64

Scheduled Maintenance Record.....70

Introduction

ABOUT THIS SUPPLEMENT

This supplement will acquaint you with the Power Stroke diesel engine. It provides recommendations on engine care and operating procedures. For complete vehicle information, also refer to your Owner's Manual included with the vehicle. It also describes equipment and gives specifications for equipment that was in effect when this guide was approved for printing, and should be considered a permanent part of the vehicle.

Note: *Your vehicle's powertrain control systems can detect and store information about vehicle modifications that increase horsepower and torque output such as whether or not performance-enhancing powertrain components commonly referred to as performance chips have been used. This information will stay in the system's memory cannot be erased even if the modification is removed. Ford Motor Company, Ford of Canada, Ford of Mexico and service or repair facilities can retrieve this information when servicing your vehicle. Ford Motor Company may use this information to determine if your warranty covers any needed repairs.*

Note: *Some aftermarket products may cause severe engine/transmission and/or exhaust system damage; refer to your warranty information for more information.*

Your new diesel engine will feel, drive and function somewhat differently than a gasoline engine. Therefore it is very important that you read and thoroughly familiarize yourself and others operating the vehicle with this guide. A special procedure for turning off the diesel engine is in the Starting and Stopping the Engine chapter, See **Starting a Diesel Engine** (page 9). It is important to read and understand this material in order to maintain the best service life for your engine.

Ford may discontinue models or change specifications without any notice and without incurring obligations.

Warnings

WARNING



Throughout this guide, you will find warnings identified by the warning symbol. Warnings remind you to be especially careful to reduce the risk of personal injury.

Breaking-In Your Vehicle

Your vehicle does not need an extensive break-in. Try not to drive continuously at the same speed for the first 1000 miles (1600 kilometers) of new vehicle operation. Vary your speed to allow parts to adjust themselves to other parts.

Drive your new vehicle at least 500 miles (800 kilometers) before towing a trailer. Make sure you use the specified engine oil. See **Technical Specifications** (page 56).

Do not add friction modifier compounds or special break-in oils during the first few thousand miles (kilometers) of operation, since these additives may prevent piston ring seating. See **Engine Oil Check** (page 42).

Diesel Engine Information

The diesel engine fuel system is a pressurized two-stage filtration system and consists of:

- A frame-mounted Fuel and Water Separator primary filter with an electric fuel pump and water drain
- An engine-mounted secondary fuel filter
- A fuel injector for each cylinder (8 total)
- A high-pressure fuel pump

Introduction

- A high-pressure fuel rail for each cylinder bank (2 total)
- Numerous high-pressure pipes from the high-pressure pump to the rails, and rails to the injectors

The fuel and water separator removes both water and impurities from the fuel. The engine mounted filter filters finer impurities from the diesel fuel. The engine-mounted fuel filter and the fuel and water separator filter should be changed at the recommended service interval or when indicated by the information display LOW FUEL PRESSURE message. Refer to the scheduled maintenance information in this supplement for more information.

The fuel and water separator should be drained at regular intervals (recommended at every oil change) or when indicated by the information display and water in fuel indicator light. See **Fuel Quality** (page 14).

Proper fuel filter maintenance and prompt water draining when the water in fuel light illuminates is essential to prevent injection equipment damage. Ignoring the water in fuel light can cause your vehicle to go into a reduced power mode.

A frame-mounted electric fuel pump located inside the fuel and water separator draws fuel from the fuel tank to provide pressurized fuel to the engine. The fuel pump contains a pressure relief valve for overpressure protection in the event of restricted flow.

The fuel injection system is controlled through the powertrain control module.

Engine protection mode

Ford diesel engines are equipped with engine protection and emission control systems. These systems monitor critical temperatures and pressures, and modify engine operation accordingly. These modified engine performance characteristics are normal.

If these modified engine performance characteristics persist for an extended period and either the service engine soon or powertrain malfunction, reduced power, electronic throttle control light is illuminated, have the system checked by an authorized dealer.



Service engine soon



Powertrain malfunction, reduced power, electronic throttle control

Lubrication system

It is important to change the engine oil at the recommended service intervals to maintain oil viscosity. Extending the oil and filter change interval beyond the recommended interval can negatively affect engine performance, fuel economy and engine life. See **Engine Oil Check** (page 42).

Fast start glow plug system

The diesel engine glow system consists of:

- Eight glow plugs (one per cylinder)
- Glow Plug Control Module
- Engine Coolant Temperature sensor
- Barometric pressure sensor
- Environmental temperature sensor

Introduction

The powertrain and glow plug control modules electronically control the glow plug system. After you switch the ignition on the glow plug control module immediately energizes the glow plugs. The glow plug control module using the engine coolant temperature, barometric pressure sensor and environmental temperature sensor will determine how long the glow plugs stay energized. The required time for the glow plugs to be energized decreases as the coolant temperature, barometric pressure and environmental temperature increase.



Glow Plug

Engine and secondary cooling system

The cooling system contains a primary cooling loop to cool the engine and exhaust gases and a secondary cooling loop to cool the transmission, exhaust gases, charge air, and fuel. The coolant serves three primary purposes: to provide heat transfer, freeze point protection, and corrosion protection using additives.

Vehicles with diesel engines typically are used to carry heavy loads and accumulate mileage rapidly. These two factors may cause the additives in the coolant to wear out in a shorter time. For more information about coolant additives and coolant change intervals See **General Maintenance Information** (page 58). Operating the engine with insufficient coolant or coolant additive can cause severe engine damage

Selective catalytic reduction system

Your vehicle is equipped with a selective catalytic reduction system designed to reduce emission levels of nitrogen oxides from the exhaust of your diesel engine. This system relies on the use of diesel exhaust fluid that you must replenish at certain

intervals. Failure to maintain proper diesel exhaust fluid levels or if the diesel exhaust fluid becomes contaminated will result in vehicle speed limitations or result in your vehicle entering an idle-only mode. See **Selective Catalytic Reduction System** (page 20).

Speed control

If your vehicle speed goes outside a predetermined range from the set speed, the **RSM** (Resume) function will not reset your vehicle speed. You will need to reset your vehicle speed with the **SET+** or **SET-** button after reaching the desired speed using the accelerator pedal.

Minor Troubleshooting Guide

If the engine won't crank

WARNING



Battery posts, terminals and related accessories contain lead and lead compounds. Wash hands after handling.

Turn on the headlights. If the lights are dim, do not go on at all or when the ignition is turned to START the lights become dim or go out, the battery connections may be loose or corroded, or the battery may be discharged. If there is a clicking or stuttering sound coming from the engine compartment when you turn the key to START, this may also indicate a loose or corroded battery connection.

Check the battery connections at the battery posts, cable connection to the engine grounding point and at the starter connection.

If you suspect a discharged battery, have it checked and corrected.

Introduction

- The gearshift lever must be in **P** (Park) or **N** (Neutral) in order for the starter to operate.
- Try operating the starter switch several times. This operation may clean potentially corroded contacts or make the switch temporarily operable until you can reach the dealer.
- If all electrical connections are tight and you need assistance to start, refer to Jump Starting in the Roadside Emergencies chapter of your Owner's Manual.
- Plugged radiator fins, A/C condenser and/or oil cooler
- Malfunctioning fan drive
- Driving with frozen coolant
- Sticking thermostat
- Overloading or pulling heavy trailers during hot weather
- Grill or radiator air blockage
- Slipping or missing drive belt
- Plugged or very dirty air filter

If engine cranks but won't start

Prolonged starter cranking (in excess of 10 seconds) could cause damage to the starter motor or the high-pressure fuel pump.

- Check the fuel gauge. You may be out of fuel. If the gauge shows that there is fuel in the tank, the trouble may be in the electrical system or the fuel system. If equipped with an auxiliary tank, be sure that the tank control switch is set for the tank with fuel and not on an empty tank.
- Leaving your ignition key turned to on for over two minutes without starting may make starting difficult because the glow plugs will cease activation. Reset the system by turning the ignition key to off and then back to on again.

Note: *If the system is out of fuel and the engine will not start, do not continue cranking the engine. Continued cranking can damage the high-pressure fuel pump.*

If the engine runs hot

The following could cause the engine to overheat:

- Lack of coolant
- Dirty cooling system.

If fuses burn out

WARNING



Replacement fuses and circuit breakers must always be the same rating as the original equipment shown. Never replace a fuse or circuit breaker with one of a higher rating. Higher rated fuses or circuit breakers could allow circuit overloading in the event of a circuit malfunction, resulting in severe vehicle damage or personal injury due to fire.

Burned-out or blown fuses usually indicate an electrical short-circuit, although a fuse may occasionally burn out from vibration. Insert a second fuse. If this fuse immediately burns out and you cannot locate the cause, return your vehicle to your dealer for a circuit check.

Refer to the Owner's Manual for replacement of fuses.

Selective catalytic reduction system speed limit and Idle-only modes

If the vehicle's speed is limited or in an idle-only mode, the selective catalytic reduction system may be limiting the vehicle's functions due to low or contaminated diesel exhaust fluid. Check the diesel exhaust fluid. See **Selective Catalytic Reduction System** (page 20).

Instrument Cluster

GAUGES

Cluster shown in standard measure. Metric similar.

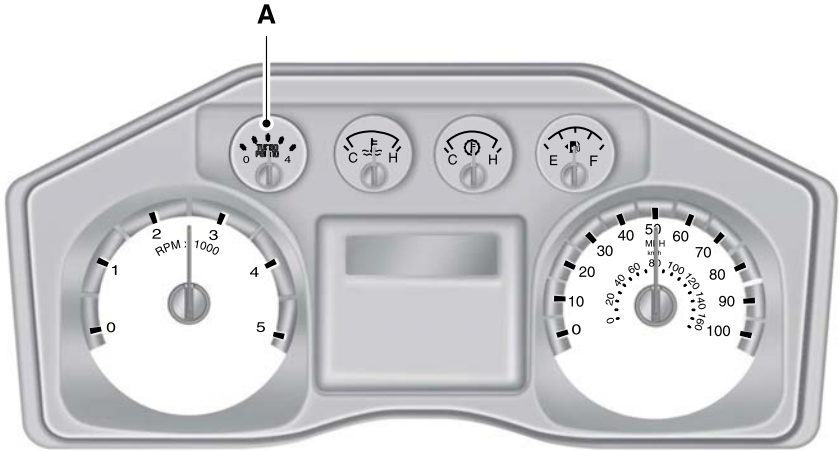

E163169

A Engine boost gauge

Engine Boost Gauge

Indicates the amount of manifold air pressure in the engine

WARNING LAMPS AND INDICATORS

The following warning lamps and indicators will alert you to a vehicle condition that may become serious. Some lamps will illuminate when you start your vehicle to make sure they work. If any lamps remain on after starting your vehicle, refer to the respective system warning lamp for further information.

Note: Some warning indicators appear in the information display and function the same as a warning lamp but do not display when you start your vehicle.

Diesel Exhaust Fluid



With the key in the on position, this light illuminates if the exhaust fluid is contaminated or low. See **Selective Catalytic Reduction System** (page 20).

Instrument Cluster

Glow Plug Pre-Heat



With the key in the on position, this light illuminates if glow plug heat is necessary as a starting aid. Wait until the light goes off before starting. See **Starting a Diesel Engine** (page 9).

After the engine starts, the light should turn off. The light should always momentarily illuminate when the engine is cold and you turn the ignition to on.

Water In Fuel



During refueling, it is possible for water-contaminated diesel fuel to be pumped into your tank.

Your vehicle's fuel system is equipped with a fuel filter/water separator to remove water from the fuel. The Water In Fuel (WIF) light will illuminate when the Fuel and Water Separator has a significant quantity of water in it and requires immediate draining.

If the water in fuel light illuminates when the engine is running, stop your vehicle as soon as safely possible, shut off the engine, then drain the fuel and water separator. See **Fuel Quality** (page 14). Allowing water to stay in the fuel system, after the water in fuel light has illuminated, could result in extensive damage or failure of the fuel injection system.

WARNING



Do not drain the fuel and water separator while the engine is running. Fuel may ignite if the separator is drained while the engine is running or the vehicle is moving.

Note: *If you drain the fuel and water separator while the system is running air will enter into the fuel system. The engine will not operate properly if air enters the system.*

Starting and Stopping the Engine

STARTING A DIESEL ENGINE

Read all starting instructions carefully before you start your vehicle.

For temperatures below 32°F (0°C), the use of the correct grade engine oil is essential for proper operation. Refer to Engine oil specifications for more information. See **Technical Specifications** (page 56).

Your vehicle may be equipped with a cold weather starting strategy that prevents severe engine damage by assisting in engine lubrication warm-up. In extremely cold ambient temperatures, this strategy activates and prevents the accelerator pedal from being used for 30 seconds after starting your vehicle. A message will appear in the information display as your vehicle warms up. By not allowing the accelerator pedal to be used, the engine oil is allowed to properly lubricate the bearings preventing engine damage due to lack of proper lubrication. After the 30 second warm-up period, the accelerator pedal will be operational again and a message will appear informing you the vehicle is ok to drive.

When starting the engine in extremely cold temperatures (-15°F [-26°C]), it is recommended to allow the engine to idle for several minutes before driving the vehicle.

Make sure the gearshift lever is in **P** (Park) and the parking brake is fully set before you turn the key. Do not press the accelerator during starting.

Cold Weather Starting

WARNINGS



Do not use starting fluid, such as ether, in the air intake system (see air filter decal). Such fluid could cause immediate explosive damage to the engine and possible personal injury

WARNINGS



Do not add gasoline, gasohol, alcohol or Kerosene to diesel fuel. This practice creates a serious fire hazard and causes engine performance problems.

It is recommended that the engine block heater be used for starting when the temperature is -10°F (-23°C) or colder. Refer to Engine block heater later in this chapter for more information.

When operating in cold weather, Motorcraft® cetane improvers or non-alcohol-based cetane improvers from a reputable manufacturer may be used as needed.

Do not crank the engine for more than 10 seconds as starter damage may occur. If the engine fails to start, turn the key to position 3 (off) and wait 30 seconds before trying again.



1. Turn the key to on without turning the key to start. Do not start the engine until the glow-plug indicator turns off.
2. When the glow plug pre-heat indicator turns off, turn the key to start and release the key as soon as the engine starts. After starting the engine, the glow plugs may remain on for a period. If you do not start the engine before the glow plug activation time ends, you will need to reset the glow plugs by turning the key to off.
3. After the engine starts, allow it to idle for about 15 seconds. This is to protect the engine. Do not increase engine speed until the oil pressure gauge indicates normal pressure.

Starting and Stopping the Engine

Cold Weather Operation

Note: *Idling in cold weather does not heat the engine to its normal operating temperature. Long periods of idling, especially in cold weather, can cause a buildup of deposits which can cause engine damage.*

Changing to a lighter grade engine oil also makes starting easier under these conditions. Refer to Engine oil specifications. See **Technical Specifications** (page 56).

Diesel fuel is adjusted seasonally for cold temperatures. Diesel fuel which has not been properly formulated for the ambient conditions may gel which can clog the fuel filters. One indication that the fuel filter(s) may be clogged is if the engine starts, stalls after a short time, and then does not restart. If you have been using biodiesel, you may need to use a fuel with lower biodiesel content, try another brand, or discontinue using biodiesel. Do not use alcohol based additives to correct fuel gelling. This may result in damage to the fuel injectors and system. Use the proper anti-gel and performance improvement product. See **Technical Specifications** (page 56).

Your vehicle is equipped with a fuel and water separator that recirculates fuel from the engine to help prevent fuel filter clogging. To avoid engine fuel starvation during cold weather operation of 32°F (0°C) or below, we recommended that the fuel level in your tank should not drop below 1/4 full. This helps prevent air from entering the fuel system and stalling the engine.

Your vehicle is equipped with a selective catalyst reduction system that uses diesel exhaust fluid to operate properly. You need to replenish your diesel exhaust fluid at certain intervals. When filling your vehicle's diesel exhaust fluid tank in cold weather, you must take special care to prevent damage to the tank. See **Selective Catalytic Reduction System** (page 20).

In cold weather below 32°F (0°C), the engine may slowly increase to a higher idle speed if left idling in P (Park). As the engine warms-up, the engine sound level decreases due to the activation of PCM-controlled sound reduction features.

If you operate your vehicle in a heavy snowstorm or blowing snow conditions, snow and ice can clog the engine air induction. If this occurs, the engine may experience a significant reduction in power output. At the earliest opportunity, clear all the snow and/or ice away from inside the air filter assembly. Remove the air cleaner cover and the pleated paper filter, leaving the foam filter in and remove any snow or ice. Make sure you install the foam filter correctly in place. Remove any debris, snow or ice on the foam filter by brushing the surface with soft brush. Once you have cleared all of the debris, reinstall the air filter and assembly.

Do not use water, solvents, or a hard brush for cleaning the foam filter.

WARNING



To reduce the risk of vehicle damage and/or personal burn injuries do not start your engine with the air filter removed and do not remove it while the engine is running.

Starting and Stopping the Engine

In order to operate the engine in temperatures of 32°F (0°C) or lower, read the following instructions:

- Make sure that the batteries are of sufficient size and are fully charged. Check other electrical components to make sure they are in optimum condition
- Use the proper coolant solution at the concentration recommended protecting the engine against damage from freezing
- Try to keep the fuel tank full as much as possible at the end of operation to prevent condensation in the fuel system
- Make sure you use proper cold weather engine oil and that it is at its proper level. Also, if necessary, make sure to follow the engine oil and filter change schedule found under the Special operating conditions section listed in the scheduled maintenance information
- At temperatures of -10°F (-23°C) or below, it is recommended that you use an engine block heater to improve cold engine starting
- If operating in arctic temperatures of -20°F (-29°C) or lower, consult your truck dealer for information about special cold weather equipment and precautions

The following cold weather idling guidelines are recommended:

- You can use Motorcraft® cetane improvers or non-alcohol-based cetane improvers from a reputable manufacturer as needed.
- Maintain the engine cooling system properly.

- Avoid shutting the engine down after an extensive idling period. Drive your vehicle for several miles with the engine at normal operating temperatures under a moderate load.
- Consider using an engine block heater.
- For extended idle times use an approved idle speed increase device.

Winter Operating Tips for Arctic Operation -20°F (-29°C) and Below

The following information is a guideline only and is no to be the only source of possible solutions in resolving extreme cold temperature issues.

Starting Aids

WARNING



Do not use starting fluid, such as ether, in the air intake system (see air filter decal). Such fluid could cause immediate explosive damage to the engine and possible personal injury.

The use of the factory engine block heater assists in engine starting in extreme cold ambient temperatures. Refer to Engine block heater in the Starting and Stopping the Engine chapter of your Owner's Manual.

Idle Control

Your vehicle may have a factory option for a stationary elevated idle control through dash-mounted upfitter switches that allows the operator to elevate the idle rpm for extended idle periods, as well as aftermarket equipment such as PTO operation. You must configure this feature even if ordered from the factory. See your authorized dealer for required upfitting.

Starting and Stopping the Engine

Operation in Snow and Rain

Vehicle operation in heavy snowfall or extreme rain conditions may feed excessive amounts of snow or water into the air intake system. This could plug the air filter with snow and may cause the engine to lose power and possibly shut down.

We recommend the following actions after operating your vehicle up to 200 miles (320 kilometers) in snowfall or extreme rain:

- Snow: At the earliest opportunity, open the hood and clear all the snow and ice from the air filter housing inlet (do not remove the foam filter) and reset the air filter restriction gauge.

Note: *Removal of the foam filter degrades your vehicle performance during snow and hot weather conditions.*

- Extreme rain: The air filter dries after about 15–30 minutes at highway speeds. At the earliest opportunity, open the hood and reset the air filter restriction gauge.

Refer to Air filter and restriction gauge in the Maintenance chapter for more information. See **Changing the Engine Air Filter** (page 49).

Operation in Standing Water

Ingestion of water into the diesel engine can result in immediate and severe damage to the engine. If driving through water, slow down to avoid splashing water into the intake. If the engine stalls, and you suspect ingestion of water into the engine, do not try to restart the engine. Consult your dealer for service immediately.

Your fuel tank vents to the atmosphere by valves on top of the tank and through the fuel cap. If water reaches the top of the tank, the valves may pull water into the fuel tank. Water in the fuel can cause performance issues and damage the fuel injection system.

SWITCHING OFF THE ENGINE

Turn the ignition to the off position.

To prolong engine life (especially after extended high speed, high ambient temperature, or high GVW/GCW operation, such as heavy loads or heavy trailers), it is recommended that a hot engine be idled for 3-5 minutes. This allows the turbocharged engine to cool down. For more information on GVW/GCW, see the Load Carrying chapter in your Owner's Manual.

ENGINE IDLE SHUTDOWN

Your vehicle may be equipped with an engine idle shutdown system. This system automatically shuts down your engine when it has been idling in **P** (Park) or **N** (Neutral) for five minutes (parking brake set) or 15 minutes (parking brake not set). When the engine idle shutdown process has started:

- A chime sounds and the information display will show ENGINE TURNS OFF IN 30 (seconds) and start counting down
- You can restart the five or 15-minute timer by changing the position of the accelerator pedal, brake pedal or the park brake within the final 30 seconds
- When the timer reaches zero, the engine shuts down and this message will appear in your information display ENGINE TURNED OFF

Starting and Stopping the Engine

- One minute after the engine has shut down, the electrical system simulates key off, even though the ignition is still in the on position, initiating normal accessory delay period
- You must move the ignition to the off position to reset the system before restarting your vehicle.

The engine idle shutdown idle timer does not start if:

- The engine is operating in power take-off mode.
- The engine coolant temperature is below 60°F (16°C).
- The exhaust emission control device is regenerating.

ENGINE BLOCK HEATER (IF EQUIPPED)

Refer to the Starting and Stopping the Engine chapter in your Owner's Manual.

Rapid Heat Supplemental Heating System

Note: *Additional aftermarket electrical loads operated during engine warm up may affect the performance of the rapid heat supplemental heater.*

The optional rapid heat feature is an electrically powered device that provides supplemental heat during engine warm up. During initial warm up, you should use a mid to low blower speed for maximum effectiveness. When operating in automatic mode (when equipped) the climate control unit determines the appropriate blower speed for existing conditions.

Fuel and Refueling

FUEL QUALITY

Fuel Requirements - Choosing The Right Fuel: Vehicles Operated Where Ultra Low Sulfur Diesel Fuel Is Required (United States/Canada/Puerto Rico/U.S. Virgin Islands And Other Locales)

Note: *Your warranty will not cover damage caused by using an improper type of fuel or fuel additive.*

Note: *Do not blend used engine oil with diesel fuel under any circumstances. Blending used oil with the fuel will significantly increase your vehicle's exhaust emissions and reduce engine life due to increased internal wear.*

You should use Ultra-Low Sulfur Diesel fuel (also known as ULSD) designated as number 1-D or 2-D with a maximum of 15-ppm sulfur in your diesel vehicle. You may operate your vehicle on diesel fuels containing up to 20% biodiesel, also known as B20. These fuels should meet the ASTM D975 diesel or the ASTM D7467 B6-B20 biodiesel industry specifications. Outside of North America, use fuels meeting EN590 or equivalent local market standard.



Using low sulfur diesel fuel (16-500 ppm) or high sulfur diesel fuel (greater than 500 ppm) in your diesel engine will cause certain emission components to malfunction which may also cause the service engine soon light to illuminate indicating an emissions-related concern.

Diesel fuel is adjusted seasonally for cold temperature. For best results at temperatures below 20°F (-7°C), it is recommended to use a diesel fuel which has been seasonally adjusted for the ambient conditions.

Fuel Requirements - Choosing The Right Fuel: Vehicles Operated Where Ultra Low Sulfur Diesel Fuel Is Not Required

For the engine to operate reliably on low-sulfur or high-sulfur diesel fuel, the engine must be a factory built high-sulfur engine (available as a dealer order option for select markets) or an ultra low sulfur diesel fuel configured engine that has been retrofitted for high-sulfur diesel fuel using Ford Motor Company dealer service parts. Failure to use retrofit components other than those available through your authorized dealer will result in coolant system damage, engine overheating, selective catalyst reduction system or diesel particulate filter damage and possible base engine damage.

Use only a diesel engine configured for use with high sulfur diesel fuel in markets with diesel fuel that has sulfur content greater than 15 ppm. Using low sulfur diesel fuel (16-500 ppm) or high sulfur diesel fuel (greater than 500 ppm) in a diesel engine designed to use only Ultra Low Sulfur Diesel fuel may result in damage to engine emission control devices and the aftertreatment system, potentially rendering the vehicle inoperable.

Vehicles with engines configured for use with high sulfur diesel fuel are only available for sale in countries where ultra low sulfur diesel fuel is generally not available or mandated by the government. Vehicles originally sold in a ultra low sulfur diesel fuel market that are subsequently exported to non- ultra low sulfur diesel fuel markets will need to be retrofitted (at the customer's expense using Ford authorized dealer service parts) in order to be reliably operated on non- ultra low sulfur diesel fuel.

Fuel and Refueling

Biodiesel

WARNING



Do not use home heating oil, agricultural fuel, raw fats and oils, waste cooking greases, biodiesel fuels greater than 20% or any diesel fuel not intended for highway use. Damage to the fuel injection system, engine and exhaust catalyst can occur if an improper fuel is used. Do not add gasoline, gasohol or alcohol to diesel fuel. This practice creates a serious fire hazard and engine performance problems.

You may operate your vehicle on diesel fuels containing up to 20% biodiesel, also known as B20.

Biodiesel fuel is a chemically converted product from renewable fuel sources, such as vegetable oils, animal fats and waste cooking greases.

To help achieve acceptable engine performance and durability when using biodiesel in your vehicle:

- Confirm the biodiesel content of the fuel to be B20 (20% biodiesel) or less
- Only use biodiesel fuel of good quality that complies with industry standards
- Follow the recommended service maintenance intervals. See **General Maintenance Information** (page 58).
- Do not store biodiesel fuel in the fuel tank for more than 1 month
- Consider changing brands or reducing biodiesel content if you have cold temperature fuel gelling issues or a frequent LOW FUEL PRESSURE message appearing
- Do NOT use raw oils, fats or waste cooking greases

Use of biodiesel in concentrations greater than 20% may cause damage to your vehicle, including engine and/or exhaust after-treatment hardware (exhaust catalyst and particulate filter) failures. Concentrations greater than 20% can also cause fuel filter restrictions that may result in a lack of power or damage to fuel system components, including fuel pump and fuel injector failures.

SAE 5W-40 or SAE 15W-40 oil is recommended for fuels with greater than 5% biodiesel (B5). Refer to the Special operating conditions section under the Schedule Maintenance chapter for more information about oil change intervals and other maintenance when operating on biodiesel.

Look for a label on the fuel pump to confirm the amount of biodiesel contained in a diesel fuel. Biodiesel content is often indicated with the letter B followed by the percent of biodiesel in the fuel. For example, B20 indicates a fuel containing 20% biodiesel. Ask the service station attendant to confirm the biodiesel content of a diesel fuel if you do not see a label on the fuel pump.

Biodiesel fuels degrade more easily than diesel fuels not containing biodiesel and should not be stored in the fuel tank for more than 1 month. If you plan to park or store your vehicle for more than 1 month, then you should empty your vehicle fuel tank of biodiesel fuel. You should fill the tank with a pure petroleum-based diesel fuel and run your vehicle for a minimum of 30 minutes.

Note: *Degraded or oxidized biodiesel can damage fuel system seals and plastics and corrode steel parts.*

During cold weather, if you have problems operating on biodiesel, you may need to use a diesel fuel with lower biodiesel content, try another brand, or discontinue the use of biodiesel.

Fuel and Refueling

Diesel Fuel Additives

It should not be necessary to add any aftermarket additives to your fuel if you use a high quality diesel fuel that conforms to ASTM industry specifications. Aftermarket additives can damage the fuel injector system or engine.

Use Motorcraft® cetane booster or an equivalent cetane booster additive if you suspect fuel has low cetane. Use Motorcraft® anti-gel & performance improver or an equivalent additive if there is fuel gelling.

Do not use alcohol-based additives to improve cetane quality, to prevent fuel gelling or any other use. The use of alcohol additives may result in damage to the fuel injectors and system. See **Technical Specifications** (page 56).

Your warranty may not cover repairs needed to correct the effects of using an aftermarket product that does not meet Ford specifications in your fuel.

Note: *Ultra Low Sulfur Diesel fuel is designed to meet the emissions standards for the 6.7L engine and is backward compatible as well (for example, it can be used in the 7.3L, 6.9L, 6.4L and 6.0L diesel engines in Ford vehicles.*

Fuel And Water Separator

Your vehicle is equipped with a diesel fuel conditioner module located on the frame-rail under the driver-side floorboard near the transmission.



You should drain water from the module assembly whenever the warning light comes on and the message center directs you to drain the water separator. This will occur when approximately 0.32 pints (150 ml) of water accumulates in the module. If you allow the water level to exceed this level, the water may pass through to the engine and may cause fuel injection equipment damage.

Draining the Diesel Fuel Conditioner Module (DFCM)

WARNING



Your vehicle must be stopped with the engine off when draining the Diesel Fuel Conditioner Module. Fuel may ignite if the separator is drained while the engine is running or vehicle is moving.

Note: *If you drain the diesel fuel conditioner module while the system is running air will enter into the fuel system. The engine will not operate properly if air enters the system.*

Note: *With fuel tank levels above 3/4 tank it may be necessary to loosen the bowl 3 turns before opening the drain. This will actuate an anti-siphon valve at the fuel and water separator inlet and prevent the fuel from siphoning out of the tank.*

Note: *A loose drain valve can allow air to enter the fuel system and cause drivetrain issues. The engine will not operate properly. Be sure that you fully tighten the drain valve.*

1. Stop your vehicle and shut off the engine.
2. Locate the diesel fuel conditioner module and place an appropriate container under the drain port.

Fuel and Refueling

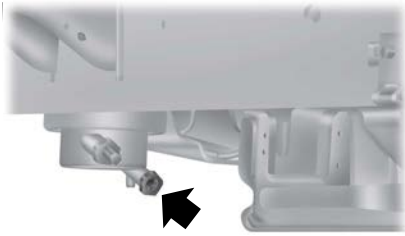

E163360

3. Rotate the drain counterclockwise until the O-ring is visible. Allow the diesel fuel conditioner module to drain for approximately 25 seconds or until clean fuel is observed. Rotate the drain clockwise to tighten it. If no liquid drains, there may be a clog in the drain. Have the conditioner module serviced by an authorized dealer.
4. Make sure that you fully tighten the drain valve and then remove the container from under your vehicle.
5. Restart the engine. If the WATER IN FUEL DRAIN FILTER or WATER IN FUEL DRAIN FILTER SEE MANUAL message and light continues to illuminate, have the fuel system checked and repaired.

Low Fuel Pressure

The engine is equipped with a low fuel pressure detection system. Here are some possible causes if a low fuel pressure message appears in the information display:

- Cold start or during cold operation (below 32°F (0°C)): If the low fuel pressure message appears during a cold start or up to 10 minutes after the initial cold start, monitor the information display. If the low fuel pressure message disappears and does not re-appear after the engine has fully warmed up, waxed or gelled fuel is

what most likely caused the message. Do not use alcohol based additives to correct fuel gelling. This may result in damage to the fuel injectors and systems. Use an anti-gel additive. See **Technical Specifications** (page 56).

Note: *Your customer warranty may be void from using additives that do not meet or exceed Ford specifications. If the low fuel pressure message persistently appears after re-fueling during the cold start and cold operation conditions defined previously and then disappear when the engine has fully warmed up, consider different fuel sources.*

- Low fuel operation: If the low fuel pressure message appears when your vehicle is warm and during low fuel tank level operation (near empty), refuel your vehicle. If the message reappears after fueling, see below. If the message does not come back, the low fuel pressure condition was due to low fuel levels in the fuel tank.
- Normal operation: If the low fuel pressure message appears during normal operation when the engine is fully warm, and fuel level is not low, you must change the fuel filters regardless of the maintenance schedule interval.
- If replacement of the fuel filter does not remedy the low fuel pressure message during normal operation as defined above, take the vehicle to an authorized dealer.

Changing the Engine-Mounted and Diesel Fuel Conditioner Module Fuel Filters

Your vehicle is equipped with two fuel filters. The first filter mounts on top of the engine on the driver's side. The second filter, inside the diesel fuel conditioner module, is mounted on the frame rail under the driver's side floorboard near the transmission. You should replace both

Fuel and Refueling

filters at the same time. Regular fuel filter changes are an important part of engine maintenance; failing to keep with the scheduled maintenance could lead to engine performance issues and fuel injection system damage. Refer to the scheduled maintenance information of this supplement for more information. See **General Maintenance Information** (page 58).

Refer to Motorcraft part numbers in the Capacities and Specifications chapter for the fuel filter replacement part number. See **Motorcraft Parts** (page 54). This part number includes filters and seals for both the engine-mounted and frame-mounted filters.

Removal - Diesel Fuel Conditioner Module filter

The diesel fuel conditioner module filter is located in the lower portion of the housing.

1. Drain the diesel fuel conditioner module. See Draining the Fuel and Water Separator earlier in this chapter.
2. Remove the lower portion of the diesel fuel conditioner module housing (filter bowl) by turning it counterclockwise using a 32 mm socket.



Note: Depending on the amount of seal swelling, removal of the filter bowl may be noisy and require some effort. Replace the seal prior to reinstalling the filter bowl to improve assembly.

3. Remove and discard the old fuel filter element.
4. Carefully clean the mating surfaces using a lint-free rag.

Installation – Diesel Fuel Conditioner Module filter

1. Install the new filter into the filter bowl tabs and replace the seal on the diesel fuel conditioner module header (top portion of separator). Refer to Motorcraft part numbers in the Capacities and Specifications chapter for the fuel filter kit part number. See **Motorcraft Parts** (page 54).
2. Lube O-ring with lubricant packet in the filter kit. This will assist in making sure the filter is properly tightened.

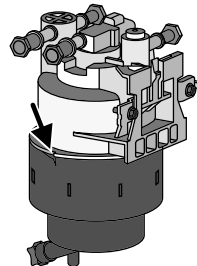

3. Reinstall the lower portion of the housing by slowly turning it clockwise onto diesel fuel conditioner module housing, allowing fuel to soak into the fuel filter element. Tighten the lower housing until it contacts the mechanical stop.

Fuel and Refueling

Note: The engine will not run properly if you do not install the diesel fuel conditioner module fuel filter in the housing or if the filter bowl is not tightened to the mechanical stop.

Note: You will need to purge the system of air after removal or changing of the filter. See purging air from the fuel system later in this chapter.

Removal - Engine-mounted fuel filter

The engine-mounted fuel filter is a plastic disposable cartridge. To remove it, do the following:

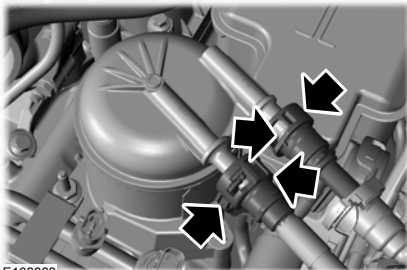

E163363

1. Disconnect both fuel lines by squeezing the connector tabs and pulling the lines straight off.



E163364

Note: Although the fuel system is not fully pressurized when the vehicle is off, some residual pressure may remain in the fuel system since it can take some time for the pressure to completely bleed off. Therefore, we recommend you place a shop rag below the filter connectors to absorb the small amount of fuel that will drain.

2. Rotate the filter fully counterclockwise until the peg is at the far end of the slot.
3. Pull the filter straight up from the bracket and discard the filter.

Installation – Engine-mounted fuel filter

1. Install the new filter into the filter bracket. Turn the filter clockwise to lock it in place.
2. Reconnect both fuel lines.

Note: Using a fuel that has more than average impurities may require you to replace the fuel filter more frequently than the service interval specifies.

Note: You will need to purge the system of air after removal or changing of the filter. See purging air from the fuel system later in this chapter.

Purging air from the fuel system

Turn the ignition key to on for 30 seconds, then turn it to off. Do this six times in a row to purge any trapped air from the fuel system.

After filter service, a no start or rough running engine may indicate that air is entering the system through the filter bowl seal or drain. Make sure the drain is tight and you tightened the filter bowl to the mechanical stop.

Fuel and Refueling

SELECTIVE CATALYTIC REDUCTION SYSTEM

Your vehicle is equipped with a selective catalytic reduction system to help reduce emission levels of oxides of nitrogen from the exhaust of the diesel engine. The system automatically injects diesel exhaust fluid into the exhaust system to enable proper selective catalytic reduction function.

Importance of maintaining the Diesel Exhaust Fluid level

In order for the selective catalytic reduction system to operate properly, the diesel exhaust fluid level must be maintained. Generally, the diesel exhaust fluid tank should be filled during the oil change service interval. See **General Maintenance Information** (page 58). However, certain conditions or driving styles, such as trailer towing or fast rates of acceleration, will require the refilling of the diesel exhaust fluid tank more often.

The engine control unit will monitor the amount of fluid available in the diesel exhaust fluid tank. Running a system check in the message center will indicate whether the diesel exhaust fluid level is ok or if it is less than 1/2 full. A message will display in the message center when the diesel exhaust fluid level is low and needs to be refilled. When you see this message, you should refill your tank. See the Information displays chapter of your Owner's Manual for information display functions. For instructions on refilling your diesel exhaust fluid tank, see filling the diesel exhaust fluid tank in this supplement.

Diesel Exhaust Fluid warning messages and vehicle operations

WARNINGS



Diesel exhaust fluid must be refilled when low or replaced when contaminated or the vehicle speed will be speed limited to 50 mph (80 km/h). In these conditions, drive with caution and refill diesel exhaust fluid immediately. If the diesel exhaust fluid becomes empty or contaminated and fluid is not replaced, your vehicle will become limited to idle speed only once stopped. In these conditions, be cautious where you stop your vehicle because you may not be able to drive long distances and will not be able to maintain highway speeds until diesel exhaust fluid is refilled or replaced.



Tampering or disabling your vehicle's exhaust aftertreatment system will result in severe vehicle performance limitation including eventual speed limiting to 5 mph.

Your vehicle's information display will display a series of messages regarding the amount of diesel exhaust fluid available. A systems check will display messages indicating the amount of diesel exhaust fluid available (OK or under 1/2 full) or will produce a warning message that displays the mileage (kilometers) remaining as the fluid in the diesel exhaust fluid tank nears empty. For more information on warning messages, see the Information Displays chapter of your Owner's Manual.



As the diesel exhaust fluid level nears empty, the diesel exhaust fluid warning symbol will be displayed and chimes will sound with the messages starting at 500 miles (805 km) remaining before diesel exhaust fluid is depleted. The warning symbol and messages will continue until you refill the diesel exhaust fluid tank.

Fuel and Refueling

Continued driving without refilling will result in the following actions as required by the California Air Resources Board (CARB) and the U.S. Environmental Protection Agency (EPA):

- Within a certain number of miles (kilometers) to empty, speed will be limited upon vehicle restart. Prior to this occurring a message will appear in the information display.
- Further vehicle operation without refilling your diesel exhaust fluid tank will cause the engine to enter an idle-only condition. This will only occur upon vehicle refueling or at an extended idle. A message will indicate the required actions to resume normal operation. It is required to add a minimum of 0.5 gallons (1.9L) of diesel exhaust fluid to the tank to exit the idle-only condition, but your vehicle will still be in the speed-limiting mode until you refill the tank completely.

For either vehicle speed limiting or idle-only condition, normal vehicle operation will resume when you refill the diesel exhaust fluid tank.

Note: *When filling the diesel exhaust fluid tank from empty, there may be a short delay before detecting the increased level of fluid. The increased level detection must occur before your vehicle returns to full power.*

Low DEF Warnings and Actions — Instrument Cluster Messages (Optional message center messages shown, base message center messages similar)			
Cluster Message	Distance/Exhaust Fluid Level or Action	Customer Requested Actions	Vehicle Actions
Exhaust Fluid Level OK	Full exhaust fluid tank	Drive normally	None
Exhaust Fluid Under 1/2 Full	Exhaust fluid tank below 1/2 full	Drive normally	None
Exhaust Fluid Range 500 miles (805 km)	Approximately 500 miles (805 km) left before exhaust fluid tank is empty	Refill exhaust fluid	None
In 99 Miles (159 km) Speed Limited to 50 MPH (80 km/h) Exhaust Fluid Empty	Approximately 99 Miles (159 km) left before exhaust fluid tank is empty	Refill exhaust fluid	None

Fuel and Refueling

Low DEF Warnings and Actions — Instrument Cluster Messages (Optional message center messages shown, base message center messages similar)			
Speed Limited to 50 MPH (80 km/h) Upon Restart Exhaust Fluid Empty	0 Miles (0 km) – exhaust fluid tank is empty	Refill exhaust fluid	None
Speed Limited To 50 MPH (80 km/h) Exhaust Fluid Empty	Vehicle restarted with exhaust fluid tank empty	Refill exhaust fluid	Speed is limited to 50 MPH. (80 km/h)
Engine Idled Soon Exhaust Fluid Empty	This occurs 200 Miles (322 km) after the vehicle reaches the 0 mile (0 km) exhaust fluid range	Refill exhaust fluid	-
Engine Idled-See Owner's Manual Exhaust Fluid Empty	This occurs when the exhaust fluid is empty and: The vehicle's diesel fuel tank is refueled or, the engine is shut off for 10 minutes or, the engine is idling with the parking brake engaged for 60 minutes.	Refill exhaust fluid	Engine is limited to idle ONLY

Filling the Diesel Exhaust Fluid tank

WARNINGS

 Make sure that diesel exhaust fluid does not come into contact with eyes, skin or clothing. Should diesel exhaust fluid contact your eyes, flush them with plenty of water and contact a physician. Clean affected skin with soap and water. If diesel exhaust fluid is swallowed, drink plenty of water and contact a physician immediately

WARNINGS

 Refill diesel exhaust fluid in a well-ventilated area. When opening the cap on the diesel exhaust fluid tank or bottle containing diesel exhaust fluid, ammonia vapors may escape. The vapors can be irritating to skin, eyes and mucous membranes. Inhaling ammonia vapors can cause burning to the eyes, throat and nose and cause coughing and watery eyes.

Note: Do not put diesel exhaust fluid in the fuel tank. This can cause engine damage not covered by your vehicle's warranty.

Fuel and Refueling

Note: *Immediately wipe away any diesel exhaust fluid that has spilled on painted surfaces with water and a damp cloth to prevent damage to the paint.*

Your vehicle is equipped with a diesel exhaust fluid tank with a blue-capped filler port located next to the diesel fuel fill inlet. The tank can be filled using a nozzle at a diesel exhaust fluid filling station (similar to fuel fill) or using a diesel exhaust fluid bottle with a spout. We recommend Motorcraft® diesel exhaust fluid bottles since they are designed to be spill proof and will stop the flow of diesel exhaust fluid when the tank is full. You can use other aftermarket bottles, but they should have a seal on the spout and an internal vent tube to achieve best fill performance and prevent overfilling. Overfilling your diesel exhaust fluid tank can cause damage to the tank. For diesel exhaust fluid capacity. See **Technical**

Specifications (page 56).

You can purchase diesel exhaust fluid at your authorized dealer, most highway truck stops or you can contact roadside assistance for help in finding a retailer that sells diesel exhaust fluid. See the Customer Assistance chapter in the Owner's Manual for more information. In addition, there is a government website locator for diesel exhaust fluid at the following web address to find the nearest location to purchase diesel exhaust fluid:

<http://www.afdc.energy.gov/afdc/locator/def>.

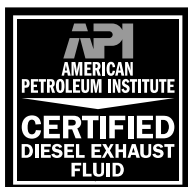

E163354

Use only diesel exhaust fluid certified by the American Petroleum Institute (API) such as Motorcraft® diesel exhaust fluid or equivalent meeting Ford specification WSS-M99C130-A and/or ISO 22241. Look for API certification trademark shown here. Your vehicle's warranty will not cover repairs resulting from the use of non-certified diesel exhaust fluid products.

Maintaining the purity of diesel exhaust fluid is important to avoid malfunctions in the selective catalytic reduction system.

If you remove the diesel exhaust fluid for tank repair, you cannot use the same fluid to refill the tank. You can no longer guarantee the purity of the diesel exhaust fluid.

To fill the diesel exhaust fluid tank in cold climates, see filling the diesel exhaust fluid tank in cold climates later in this section or see an authorized dealer.

Diesel Exhaust Fluid bottle fill with spout

The following procedure applies to Motorcraft® diesel exhaust fluid or similar diesel exhaust fluid bottles; for other brands or bottle types, refer to the instructions on the bottle label.

1. Remove the cap from the diesel exhaust fluid container. Remove the spout from the bottle and insert the straw end into the bottle. Ensure you align the arrow above the nut with the bottle handle and the small tube end extends into the far corner of the bottle. Twist the spout nut on the container until it is tight.

Fuel and Refueling

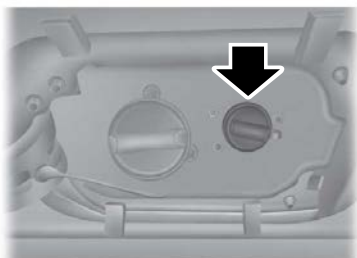

E163355

2. Open the diesel exhaust fluid filler port on your vehicle by turning the blue cap counterclockwise. Do not put diesel exhaust fluid in the fuel tank. This can cause engine damage not covered by your vehicle's warranty.

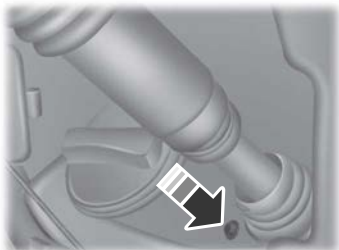

E163356

3. Lift and hold the diesel exhaust fluid container, without tipping, and insert the spout into the diesel exhaust fluid filler port until the small black seal on the spout completely seats into the filler port.



E163357

4. While filling, the fluid level in the bottle will continually drop.



E163358

5. When the diesel exhaust fluid tank is full, the fluid level in the bottle will stop dropping, indicating the fluid has stopped flowing.

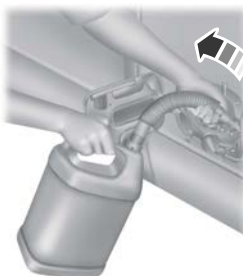

E163359

Fuel and Refueling

- Once the level in the diesel exhaust fluid bottle has stopped dropping, return the container to the vertical position slightly below the diesel exhaust fluid filler port and let any diesel exhaust fluid drain out of the spout. DO NOT try to continue to add diesel exhaust fluid to the tank by shaking or repositioning the container to induce flow. This may cause spilling and overfill the tank. Overfilling the diesel exhaust fluid tank can cause damage to the tank.
- Once the spout has drained, remove the spout from the diesel exhaust fluid filler port and install the blue cap on the diesel exhaust fluid filler port.
- Remove the spout from the diesel exhaust fluid container and install the cap back on the bottle.
- If the container is empty, discard the empty container, or recycle if possible. If there is diesel exhaust fluid left in the container, retain it for later use. The spout is re-useable; after use, rinse it with clean water and store the spout to keep it clean. Do not use the diesel exhaust fluid spout with any other chemicals.
- Wipe away any diesel exhaust fluid that has spilled on painted surfaces with water and a damp cloth.

Diesel Exhaust Fluid filling station nozzle fill

Filling the diesel exhaust fluid tank using a nozzle is similar to a normal fuel fill. The nozzle will shut off automatically when the tank is full. Do not continue to fill the tank as this may cause spilling and overfill can cause damage to the tank.

Note: *Some filling station nozzles may prevent filling of your diesel exhaust fluid tank due to a magnetic mechanism in the nozzle. This is not a problem with your vehicle. To refill your tank either locate another filling station or use a bottle to refill the tank.*

Filling the Diesel Exhaust Fluid tank in cold climates

Diesel exhaust fluid will freeze below 12°F (-11°C); however, your vehicle is equipped with an automatic preheating system which allows the diesel exhaust fluid system to operate below 12°F (-11°C). When your vehicle is not in operation for an extended period with temperatures at or below 12°F (-11°C), the diesel exhaust fluid tank could freeze. If the tank is OVERFILLED and freezes, it could be damaged, therefore DO NOT OVERFILL.

To prevent overfilling of the diesel exhaust fluid tank when filling with a bottle, Ford recommends using Motorcraft® diesel exhaust fluid. Additionally, if the information display indicates EXHAUST FLUID UNDER 1/2 FULL, you should only add a MAXIMUM of 2 gallons (6.7L) of diesel exhaust fluid to the tank to prevent freeze damage due to overfilling. If the information display indicates EXHAUST FLUID LEVEL OK, do not add diesel exhaust fluid.

Contaminated Diesel Exhaust Fluid or inoperative Selective Catalytic Reduction system



Selective catalytic reduction systems are sensitive to contamination of the diesel exhaust fluid. USE ONLY API or ISO 22241 CERTIFIED DIESEL EXHAUST FLUID. If the selective catalytic reduction system becomes contaminated or inoperative, the diesel exhaust fluid light will illuminate and exhaust fluid system fault messages will appear in the information display.

Fuel and Refueling

Continued driving without replacing diesel exhaust fluid or having the selective catalytic reduction system repaired will result in the following actions as required by the California Air Resources Board (CARB) and U.S. Environmental Protection Agency (EPA):

- Within a certain number of miles (kilometers) to empty, speed will be limited upon restart. Prior to this occurring a message will appear in the information display.
- Further vehicle operation without replacing contaminated diesel exhaust fluid will cause the engine to enter an idle-only condition. This will only occur upon vehicle refueling, vehicle idling in park for 1 hour, or engine shutdown for 10 minutes or more and will be indicated by a message in the information display indicating required actions to resume normal operation.

For either vehicle speed limiting or idle-only condition, normal vehicle operation will resume when you repair the contaminated system. To service a contaminated or inoperative system, see an authorized dealer.

Diesel Exhaust Fluid guidelines and information

- Use only diesel exhaust fluid that carries the trademark: American Petroleum Institute (API) certified DEF or ISO 22241.
- Do not put diesel exhaust fluid in the diesel fuel tank.
- Do not overfill the diesel exhaust fluid tank.

- Do not re-use the diesel exhaust fluid container once it is emptied.
- Avoid spilling diesel exhaust fluid on painted surfaces, carpeting or plastic components. Immediately wipe away any diesel exhaust fluid that has spilled with a damp cloth and water. If it has already crystallized, use warm water and a sponge.
- Store diesel exhaust fluid out of direct sunlight and in temperatures between 23°F (-5°C) — 68°F (20°C).
- Diesel exhaust fluid will freeze below 12°F (-11°C).
- Do not store the diesel exhaust fluid bottle in your vehicle. If it leaks it could cause damage to interior components or release an ammonia odor inside your vehicle.
- Diesel exhaust fluid is non-flammable, non-toxic, colorless and water-soluble liquid.
- Do not dilute diesel exhaust fluid with water or any other liquid.
- An ammonia odor may be smelled when the cap is removed or during refill. Refill diesel exhaust fluid in a well ventilated area.

Typical Diesel Exhaust Fluid Usage

The charts below illustrate approximate diesel exhaust fluid usage for the given distances traveled under various driving conditions and when using the power take off. Your usage may vary depending on: driving style, trailer towing, loaded vehicle weight, weather, idle time, PTO usage.

Fuel and Refueling

Pick-up (3.31 axle ratio)

Pick-up (3.31 axle ratio)			
Driving style	Trailer towing / aggressive or city driving	Normal driving	Steady highway driving
Diesel Exhaust Fluid usage	4100 miles (6598 km) – 7100 miles (11426 km)	7100 miles (11426 km) – 9600 miles (15450 km)	9600 miles (15450 km) – 10000 miles (16093 km) +

Pick-up (3.55 axle ratio)

Pick-up (3.55 axle ratio)			
Driving style	Trailer towing / aggressive or city driving	Normal driving	Steady highway driving
Diesel Exhaust Fluid usage	2800 miles (4506 km) – 5800 miles (9334 km)	5800 miles (9334 km) – 8100 miles (13036 km)	8100 miles (13036 km) – 9700 miles (15611 km)

Pick-up (3.73 axle ratio)

Pick-up (3.73 axle ratio)			
Driving style	Trailer towing / aggressive or city driving	Normal driving	Steady highway driving
Diesel Exhaust Fluid usage	2050 miles (3299 km) – 5050 miles (8127 km)	5050 miles (8127 km) – 7300 miles (11748 km)	7300 miles (11748 km) – 8900 miles (14323 km)

Pick-up (4.30 axle ratio)

Pick-up (4.30 axle ratio)			
Driving style	Trailer towing / aggressive or city driving	Normal driving	Steady highway driving
Diesel Exhaust Fluid usage	1100 miles (1770 km) – 4100 miles (6598 km)	4100 miles (6598 km) – 6300 miles (10139 km)	6300 miles (10139 km) – 7900 miles (12714 km)

Fuel and Refueling

Chassis cab (non–Power Take Off)			
Driving style	Trailer towing / aggressive or city driving	Normal driving	Steady highway driving
Diesel Exhaust Fluid usage	1700 miles (2736 km) – 4700 miles (7564 km)	4700 miles (7564 km) – 7800 miles (12553 km)	7800 miles (12553 km) – 9300 miles (14967 km)

Chassis cab (with Power Take Off)	
PTO usage	Cont. PTO usage — Min. PTO usage
Diesel Exhaust Fluid usage	0 miles (0 km) – 7800 miles (12553 km)

REFUELING

Fueling Tips

WARNING



Do not use starting fluid such as ether or gasoline in the diesel air intake system. Such fluids can cause immediate explosive damage to the engine and possible personal injury.

Truck stops have pumps and nozzles designed for larger, heavy-duty trucks. When refueling at truck stops: if the nozzle shuts off repeatedly when refueling, wait 5–10 seconds; then use a slower rate of flow (don't depress the nozzle trigger as far).

If air is allowed to enter the fuel system (during fuel filter change or if you run out of fuel) the engine will purge the trapped air as it runs. To purge the air sooner: prior to engine start, prime the system by turning the key to on for 30 seconds then to off. Repeat this several times. The engine may run rough and produce white smoke while air is in the system. This is normal.

An engine that suddenly becomes noisy or operates poorly after a fuel fill could be using substandard fuel (for example, high water content, low cetane rating or gasoline in the fuel). You should purchase diesel fuel from a reputable station that sells a large amount of diesel fuel.

Use only clean, approved containers that will prevent the entry of dirt or water whenever you store diesel fuel.

Diesel fuel must not be stored in a galvanized container. The fuel will dissolve the zinc in the galvanized container. The zinc will then remain in the fuel. If you run the contaminated fuel through the engine, the zinc will deposit in the fuel injectors causing expensive-to-repair damage.

Fuel and Refueling

Diesel fuel dispensing nozzle fill rate

Your truck is equipped with a fuel fill pipe that is able to accept fuel up to 20 gallons per minute from an 1 1/8 fuel-dispensing nozzle. Pumping fuel at greater flow rates may result in premature nozzle shut-off or spit back.

Fuel filler cap

WARNINGS



The fuel system may be under pressure. If the fuel filler cap is venting vapor or if you hear a hissing sound, wait until it stops before completely removing the fuel filler cap. Otherwise, fuel may spray out and injure you or others.



If you do not use the proper fuel filler cap, excessive pressure or vacuum in the fuel tank may damage the fuel system or cause the fuel cap to disengage in a collision, which may result in possible personal injury.

Note: *If you must replace the fuel filler cap, replace it with a fuel filler cap designed for your vehicle. The vehicle warranty may be void for any damage to the fuel tank or fuel system if the correct genuine Ford or Motorcraft® fuel filler cap is not used.*

Your fuel tank filler cap has an indexed design with a 1/4 turn on/off feature.

When fueling your vehicle:

1. Turn the engine off.
2. Carefully turn the filler cap counterclockwise until it spins off.
3. Pull to remove the cap from the fuel filler pipe.
4. To install the cap, align the tabs on the cap with the notches on the filler pipe.
5. Turn the filler cap clockwise 1/4 of a turn until it clicks at least once.

EMISSION CONTROL SYSTEM

Diesel Exhaust System: Oxidation Catalyst And Diesel Particulate Filter System (If Equipped)

Your vehicle is equipped with a diesel particulate filter. The diesel particulate filter is an inline filter in the exhaust system that reduces carbon emissions by trapping exhaust particles before they reach the tailpipe. The diesel particulate filter looks similar to a traditional exhaust catalyst, except larger, and is part of the exhaust system under the vehicle. The filter couples to a diesel oxidation catalyst that reduces the amount of harmful exhaust emitted from the tailpipe. As soot gathers in the system, it begins to restrict the filter. You need to periodically clean the soot that gathers inside the. You can clean the soot in two different ways, passive regeneration and active regeneration. Both methods occur automatically and require no actions from the driver. During either one of these regeneration methods, you may notice a change in exhaust tone. At certain times, the information display will display various messages related to the diesel particulate filter. See the Information Displays chapter in the Owner Guide for more information.

Passive regeneration

In passive regeneration, the high temperature of the exhaust system automatically cleans the filter, or reduces the soot level, by burning (oxidizing) the soot. This high exhaust temperature occurs naturally because of normal engine operating conditions (at varying levels, due to driving patterns).

Fuel and Refueling

Diesel particulate filter maintenance

You must properly maintain your diesel particulate filter in order for it to function properly. Do not disregard the **EXHAUST OVERLOADED DRIVE TO CLEAN** and **EXHAUST AT LIMIT DRIVE TO CLEAN NOW** maintenance messages otherwise system damage could result that your warranty may not cover.

Failure to perform active or operator commanded regeneration when instructed might result in a clogged diesel particulate filter that your dealer cannot clean. If your diesel particulate filter fills beyond what can safely be regenerated, active regeneration and operator commanded regeneration will be disabled. This could result in irreversible damage to the filter requiring replacement that your warranty may not cover. If your vehicle is not equipped with operator commanded regeneration, check with your dealer for availability.

Once the diesel particulate filter is full of exhaust particles, the engine control module will command the exhaust system to clean the filter through a process called active regeneration. Active regeneration requires the engine computer to raise the exhaust temperature to eliminate the particles. During cleaning, the particles convert to harmless gasses. Once cleaned the diesel particulate filter will then be ready to continue trapping exhaust particles.

The regeneration process operates more efficiently when you safely operate your vehicle at least 30 mph (48 km/h) with a steady pedal for approximately 20 minutes to complete the process. The frequency and duration of regeneration will fluctuate by how you drive your vehicle, outside air temperature, and altitude. For most driving, regeneration frequency will vary from 100

- 500 miles (161 - 805 km) between occurrences and each occurrence will last from 9 - 20 minutes. You can usually reduce the duration of regeneration if you maintain a constant speed above 30 mph (48 km/h).

When the engine control module detects that the diesel particulate filter is nearly full of particulates and you are not operating your in a manner to allow effective automatic cleaning, the information display will display **EXH OVERLOADED DRIVE TO CLEAN** for base information display and **Exhaust Overloaded Drive to Clean** for the optional information display. These messages appear as a reminder for you to drive in order to clean the diesel particulate filter. If you operate your vehicle in a manner to allow effective automatic cleaning, the information display will display a cleaning exhaust filter message, which is the normal regeneration process. See the Information Displays chapter of the Owner Guide for more information.

You can also choose operator commanded regeneration to clean the exhaust system at this point. See How to start operator commanded regeneration later in this chapter.

If you are not able to drive in a manner that allows effective automatic cleaning (active regeneration) or you choose to perform regeneration of the diesel particulate filter (cleaning) while at idle (stationary), then operator commanded regeneration would need to be performed. See operator commanded regeneration later in this chapter.

Fuel and Refueling

Operator Commanded Regeneration

If your vehicle is operated with significant stationary operation, low speed drive cycles less than 25 mph, short drive cycles, a drive time is less than 10 - 15 minutes or the vehicle does not fully warm up, passive and active regeneration may not sufficiently clean the diesel particulate filter system. Operator commanded regeneration allows you to manually start regeneration of the diesel particulate filter at idle (while stationary) to clean the filter. If you are not sure whether your vehicle is equipped with this feature, contact an authorized dealer.

When to perform Operator Commanded Regeneration

Use the Operator Commanded Regeneration feature when the **EXH OVERLOADED DRIVE TO CLEAN** message appears in the information display and:

- the operator is not able to drive in manner that allows effective automatic cleaning (active regeneration),
- or the operator instead wishes to manually start regeneration (cleaning) of the diesel particulate filter while the vehicle is idle (stationary).

Operator Commanded Regeneration precautions and safe exhaust position

WARNING



Failure to comply with the following instructions for operator commanded regeneration may result in fire, serious injury, death and/or property damage.

Before you start operator commanded regeneration, do the following:

- Place your vehicle in **P** (Park) with the parking brake set on stable, level ground
- You must park your vehicle outside of any structure
- Your vehicle must be 10 – 15 feet (3 – 5 meters) away from any obstructions and must be away from materials that can easily combust or melt (for example, paper, leaves, petroleum products, fuels, plastics and other dry organic material)
- Make sure there is a minimum of 1/8 tank of fuel
- Make sure all fluids are at proper levels

Make sure that the louvers (holes) located at the tip of the exhaust are also clear of any obstructions as they are used to introduce fresh air into the tailpipe to cool the exhaust gas as it leaves. See **Cleaning the Exhaust** (page 53).

How to start Operator Commanded Regeneration

WARNING



Stay clear of exhaust tip during regeneration. You or others can be burned.

Note: *You cannot use the operator commanded regeneration until the diesel particulate filter load percentage has reached 100% (Full). The diesel particulate filter load percentage will fluctuate up and down when driving your vehicle due to active and passive regenerations.*

Note: *During the use of operator commanded regeneration, you may observe a light amount of white smoke. This is normal.*



You cannot use the operator commanded if the service engine soon light is illuminated.

Fuel and Refueling

Information display procedure

Start with your vehicle engine fully warmed and then press the Info button on the steering wheel until the information display reads one of the following choices:

If you have warmed your vehicle up and the diesel particulate filter needs cleaning, a message requesting permission to initiate filter cleaning will be displayed **EXHST XX% FULL CLEAN? Y/N** or **EXHAUST FULL CLEAN? Y/N**. Answer yes to this prompt and then follow the prompts regarding exhaust position as needed to initiate Operator Commanded Regeneration. Be sure to understand each prompt. If you are not sure what is being asked by each prompt, contact an authorized dealer. The display will confirm the operation has started and when it has finished.



If you have warmed your vehicle up and the diesel particulate filter is near or at saturation, the powertrain fault indicator will illuminate and message requesting permission to initiate filter cleaning will be displayed **EXH AT LIMIT CLEAN? Y/N**. Answer yes to this prompt and then follow the prompts regarding exhaust position as needed to initiate Operator Commanded Regeneration. Be sure to understand each prompt. If you are not sure what is being asked by each prompt, contact an authorized dealer. The display will confirm the operation has started and when it has finished. You can also drive to clean the filter. See Active regeneration earlier in this chapter.



The service engine soon light will illuminate and the following message **EXH OVER LIMIT SERVICE NOW** will appear when the system is at the point of oversaturation. You will not be able to allow cleaning. You must have your vehicle serviced by an authorized dealer.

Once operator commanded regeneration starts, the engine's rpm will rise to approximately 2,000 - 2,400 rpm and the cooling fan will increase speed; you will hear a change in audible sound due to the fan and engine speed increase.

It is not necessary to open the hood on the engine compartment. Once operator commanded regeneration is complete, the engine rpm and fan will return to normal idling. The exhaust system will remain very hot for several minutes even after regeneration is complete. Do not reposition the vehicle over materials that could burn until the exhaust system has had sufficient time to cool. Depending on the amount of soot collected by the diesel particulate filter, ambient temperature, and altitude, operator commanded regeneration may last from 10 to 25 minutes.

How to interrupt or cancel Operator Commanded Regeneration

If you need to cancel the operator commanded regeneration, pressing the brake, accelerator, or shutting off the vehicle will stop the procedure. Depending on the amount of time you allowed the operator commanded regeneration to operate, soot may not have had sufficient time to be eliminated, but the exhaust system and exhaust gas may still be hot. If you shut your vehicle off during operator commanded regeneration, you will notice turbo flutter. This is a normal consequence caused by shutting off a diesel engine during boosted operation and is considered normal.

Filter service and maintenance

Over time, a slight amount of ash will build up in the diesel particulate filter, which is not removed during the regeneration process. The filter may need to be removed for ash cleaning at approximately 120,000 miles (193,000 km) or greater (actual mileage can vary greatly depending upon

Fuel and Refueling

engine/vehicle operating conditions) and replaced with a new or remanufactured (ash cleaned) part. The filter may need to be replaced at approximately 250,000 miles (400,000 km) depending upon vehicle operating conditions.



In both cases, the engine control system will set a service light to inform you to bring the vehicle to the dealer for service.

If there are any issues with the diesel particulate filter system a service light will be set by the engine control system to inform you to bring your vehicle into an authorized dealer for service.



Powertrain fault indicator or



Service engine soon

Resonator and Tailpipe assembly maintenance

WARNINGS



Failure to maintain the functional holes, in the tailpipe section of the exhaust, clean and free of debris or foreign material may result in the holes becoming blocked or plugged. Do not modify or remove the tail-pipe section. Blocked or plugged holes or removal/modification of the system could result in elevated exhaust gas temperatures which may result in vehicle/property damage or personal injury.



The normal operating temperature of the exhaust system is very high. Never work around or attempt to repair any part of the exhaust system until it has cooled. Use special care when working around the diesel oxidation catalytic converter and/or the diesel particulate filter (DPF). The diesel

WARNINGS

oxidation catalytic converter and/or the DPF heats up to a high temperature after only a short period of engine operation and can stay hot even after the engine is turned off. Failure to follow these instructions may result in personal injury.

Note: Additions of aftermarket devices or modifications to the exhaust system can reduce the effectiveness of the exhaust system as well as cause damage to the exhaust system or engine. These actions may also affect your vehicle's warranty. See the Warranty Guide for more information.

The diesel resonator tail-pipe assembly is a uniquely functioning device that accompanies the diesel particulate filter assembly. The tail-pipe assembly serves multiple functions. First, it serves as an acoustic device to attenuate exhaust noise. Second, it provides an exit path for the exhaust from your vehicle. It also helps control the temperature of the exhaust during diesel particulate filter regeneration events. The visible holes in each leg of the twin tip and the holes under the shield just inboard of the right rear tire(s) are functional. You need to keep the holes clear of mud, debris or foreign material to maintain proper function of the exhaust system. Clean and remove debris or foreign material if present as needed. Spraying with a hose during regular washing of your vehicle should help keep holes clean and clear of debris or foreign material.

Fuel and Refueling

Emission Control System(s) Laws

WARNING



Do not remove or alter the original equipment floor covering or insulation between it and the metal floor of the vehicle. The floor covering and insulation protect occupants of the vehicle from the engine and exhaust system heat and noise. On vehicles with no original equipment floor covering insulation, do not carry passengers in a manner that permits prolonged skin contact with the metal floor. Provide adequate insulation. Failure to follow these instructions may result in fire or personal injury.

In the U.S. federal law and certain state laws prohibit removing or rendering inoperative emission control system(s). Similar federal or provincial laws may apply in Canada. Ford recommends against any vehicle modification without determining applicable law.



Tampering with emissions control systems (including related sensors and the diesel exhaust fluid injection system) can result in reduced engine power and the illumination of the service engine soon light.

Tampering with a Noise Control System

Federal law prohibits the following acts or the causing thereof: (1) The removal or rendering inoperative by any person other than for purposes of maintenance, repair or replacement of any device or element of design incorporated into any new vehicle for the purpose of noise control prior to its sale or delivery to the ultimate purchaser or while it is in use, or (2) the use of the vehicle after such device or element of design has been removed or rendered inoperative by any person.

Among those acts, which the U.S. Environmental Protection Agency may presume to constitute tampering are the acts listed below:

- Removal of hood blanket, fender apron absorbers, fender apron barriers, underbody noise shields or acoustically absorptive material.
- Tampering or rendering inoperative the engine speed governor, to allow engine speed to exceed manufacturer's specifications.

The complexity of the diesel engine makes it so the owner is discouraged from attempting to perform maintenance other than the services described in this supplement.

If you experience difficult starting the engine, rough idling, excessive exhaust smoke, a decrease in engine performance or excess fuel consumption, perform the following checks:

- A plugged or disconnected air inlet system or engine air filter element
- Water in the fuel filter and water separator
- A clogged fuel filter
- Contaminated fuel
- Air in the fuel system, due to loose connections
- An open or pinched sensor hose
- Check engine oil level
- Wrong fuel or oil viscosity for climactic conditions

If these checks do not help you correct the engine performance problem you are experiencing, consult an authorized dealer.

Fuel and Refueling

Noise Emissions Warranty, Prohibited Tampering Acts and Maintenance

On January 1, 1978, Federal regulation became effective governing the noise emission on trucks over 10,000 lbs. (4,536 kg) GVWR (Gross Vehicle Weight Rating). The preceding statements concerning prohibited tampering acts and maintenance, and the noise warranty found in the Warranty Guide, are applicable to complete chassis cabs over 10,000 lbs. (4,536 kg) GVWR.

FUEL TANK SELECTOR SWITCH



E163365

If your vehicle is equipped with dual fuel tanks, you will have a selector control, located to the right of the steering wheel, which allows you to draw fuel from either tank. Your fuel gauge and the DTE (distance to empty) will display the amount of fuel in the currently selected tank.

GENERAL INFORMATION

Integrated Engine Braking

This feature increases engine braking at higher engine speeds to provide better grade descent control with less brake and transmission wear and tear.

This feature is integrated with the tow/haul mode feature. When tow/haul mode is switched on, the integrated engine braking feature will also be active. For more information on tow/haul, see Automatic transmission operation in the Owner Manual.

Towing

TOWING A TRAILER

Refer to your Owner's Manual for full details on towing a trailer.

Vehicle Type	Rear Axle Ratio	Maximum GCWR - lb (kg)
F-250/F-350 Single Rear Wheel (SRW)	3.31/3.55/ 3.73	23500 (10659)
F-350 Dual Rear Wheel (DRW) Chassis Cab	3.73/4.10	24500 (11113)
F-350 Dual Rear Wheel (DRW) Pick-up	3.73	30500 (13835)
F-450 Chassis Cab	4.10	26000 (11793)
	4.30	30000 (13608)*
F-450 Pick-up	4.30	33000 (14969)
F-550 (17500/18000 lb GVWR)	4.10	26000 (11793)
	4.30	35000 (15875)*
F-550 (19000/19500 lb GVWR)	4.88	26000 (11793)
	4.88	35000 (15875)*

*Requires optional GCWR package

Roadside Emergencies

FUEL SHUTOFF

In the event of a moderate to severe collision, this vehicle is equipped with a fuel pump shut-off feature that stops the flow of fuel to the engine. Not every impact will cause a shut-off.

After an accident, if the engine cranks but does not start, this switch may have been activated.



E163366

This switch is located on the passenger's side of the instrument panel. Open the front passenger door and remove the small access panel



E163367

The switch has a red button on top of it.

To reset the switch:

1. Turn the ignition off.
2. Check the fuel system for leaks.

3. If no leaks are apparent, reset the switch by pushing in on the reset button.
4. Turn the ignition on.
5. Wait a few seconds and return the key to off.
6. Make another check for leaks.



Running Out Of DEF (Diesel Exhaust Fluid)

If your vehicle runs out of DEF, it will enter into a speed limited mode and can also enter into an idle-only mode. Normal vehicle operation will not resume until DEF is refilled. See **Selective Catalytic Reduction System** (page 20).

Contact roadside assistance for help in finding a retailer that sells DEF. See the Customer Assistance chapter in the Owner's Manual for more information.

JUMP-STARTING THE VEHICLE

WARNINGS

-  The gases around the battery can explode if exposed to flames, sparks, or lit cigarettes. An explosion could result in injury or vehicle damage.
-  Batteries contain sulfuric acid which can burn skin, eyes and clothing, if contacted.
-  Use only an adequate-sized cable with insulated clamps.

Preparing Your Vehicle

Note: Do not attempt to push-start your automatic transmission vehicle. Automatic transmissions do not have push-start capability. Attempting to push-start a vehicle with an automatic transmission may cause transmission damage.

Roadside Emergencies

Note: Use only a 12-volt supply to start your vehicle.

Note: Do not disconnect the battery of the disabled vehicle as this could damage the vehicle's electrical system.

Park the booster vehicle close to the hood of the disabled vehicle, making sure the two vehicles do not touch. Turn all accessories off.

Connecting the Jumper Cables

WARNING



Do not attach the cables to fuel lines, engine rocker covers, the intake manifold or electrical components as grounding points. Stay clear of moving parts. To avoid reverse polarity connections, make sure that you correctly identify the positive (+) and negative (-) terminals on both the disabled and booster vehicles before connecting the cables.

Note: In the illustration, the bottom vehicle represents the booster vehicle.

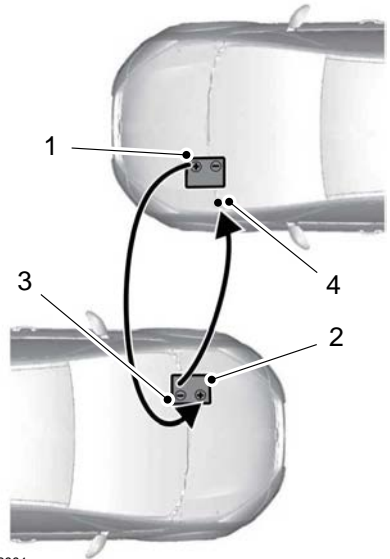

E142664

1. Connect the positive (+) jumper cable to the positive (+) terminal of the discharged battery.
2. Connect the other end of the positive (+) cable to the positive (+) terminal of the assisting battery.
3. Connect the negative (-) cable to the negative (-) terminal of the assisting battery.
4. Make the final connection of the negative (-) cable to an exposed metal part of the stalled vehicle's engine, or connect the negative (-) cable to a ground connection point if available.

WARNING



Do not connect the end of the second cable to the negative (-) terminal of the battery to be jumped. A spark may cause an explosion of the gases that surround the battery.

Roadside Emergencies

Jump Starting

1. Start the engine of the booster vehicle and rev the engine moderately, or press the accelerator gently to keep your engine speed between 2000 and 3000 rpms, as shown in your tachometer.
2. Start the engine of the disabled vehicle.
3. Once the disabled vehicle has been started, run both vehicle engines for an additional three minutes before disconnecting the jumper cables.

Removing the Jumper Cables

Remove the jumper cables in the reverse order that they were connected.

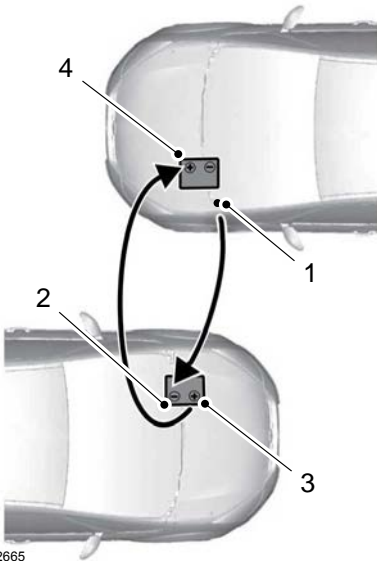

E142665

1. Remove the jumper cable from the ground metal surface or connecting point, if available.

2. Remove the jumper cable on the negative (-) terminal of the booster vehicle's battery.
3. Remove the jumper cable from the positive (+) terminal of the booster vehicle's battery.
4. Remove the jumper cable from the positive (+) terminal of the disabled vehicle's battery.

After the disabled vehicle has been started and the jumper cables removed, allow it to idle for several minutes so the battery can recharge.

Maintenance

UNDER HOOD OVERVIEW

F-Super Duty

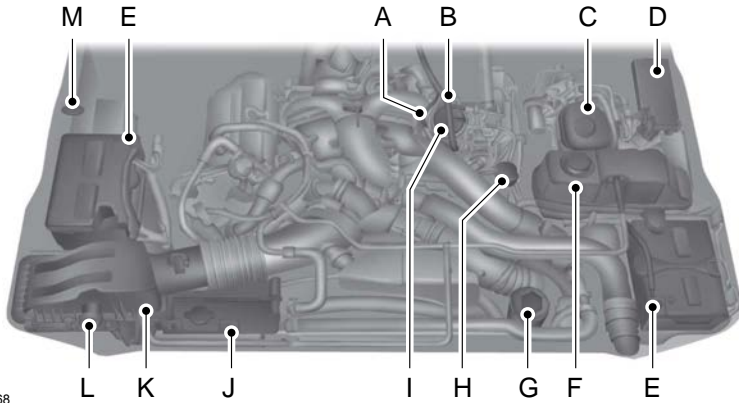

E163368

- A. Engine oil dipstick
- B. Automatic transmission fluid dipstick
- C. Brake fluid reservoir
- D. Power distribution box
- E. Batteries
- F. Engine cooling system coolant reservoir (primary high-temperature cooling system)
- G. Power steering fluid reservoir
- H. Engine oil fill
- I. Engine-mounted fuel filter assembly
- J. Secondary cooling system coolant reservoir
- K. Air filter assembly
- L. Air filter restriction gauge
- M. Windshield washer fluid reservoir

Maintenance

Scheduled Maintenance

The scheduled maintenance services in the scheduled maintenance information of this supplement are required because they are considered essential to the life and performance of your vehicle. See

General Maintenance Information

(page 58).

Use only recommended fuel, lubricants, fluids and service parts conforming to Ford specifications. Motorcraft® parts are designed and built for best performance in your vehicle.

ENGINE OIL CHECK

Because it is normal to add some oil between oil changes, check your engine oil level each time you stop for fuel. To check the engine oil level consistently and accurately, the following procedure is recommended:

1. Have engine at normal operating temperature (at least into the **NORMAL** range on the engine coolant temperature gauge).
2. Park the vehicle on a level surface, then turn off the engine and open the hood.
3. Allow at least **20 minutes** after engine shutdown to ensure that the oil contained in the upper parts of the engine has returned to the oil pan.
4. Protecting yourself from engine heat, pull out the dipstick, wipe it clean and reinsert fully.
5. Read oil level on both sides of dipstick and use highest level (reading) for the actual engine oil level.

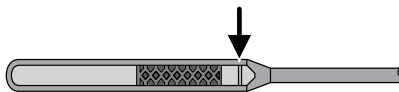

E163369

6. Maintain the oil level within the crosshatch area on the dipstick by adding oil as required. Do not overfill the oil past the maximum line as depicted by the arrow.

Engine Oil Specifications

To help achieve acceptable engine performance and durability, it is important that only engine oils of good quality are used in your diesel engine and it is changed at the recommended interval. For normal or severe service, use Motorcraft® oil or an equivalent oil conforming to Ford specifications as listed in the Capacities and Specifications chapter. See **Technical Specifications** (page 56). It is important to use these oils because they are compatible with the emission control equipment of your vehicle to meet the more stringent emission standards.

The use of correct oil viscosities for diesel engines is important for satisfactory operation. Determine which oil viscosity best suits the temperature range you expect to encounter for the next service interval from the following SAE viscosity grade chart.

Maintenance

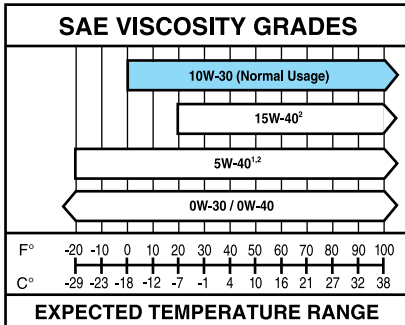

E163370

- (1) For severe duty service, use SAE 5W-40 API CJ-4.
- (2) For the use of biodiesel (grade B20 max), use SAE 5W-40 or SAE 15W-40 API CJ-4.

An engine block heater is recommended at temperatures below -10°F (-23°C).



E163371

The American Petroleum Institute (API) service symbol is used to identify the proper engine oil for your engine. The API service symbol will be displayed on the oil container you purchase. The API symbol displays the oil performance category in the top half of symbol and the viscosity grade in the center of the symbol.

Changing the Engine Oil and Oil Filter

WARNINGS



Do not handle a hot oil filter with bare hands.



Continuous contact with used motor oil has caused cancer in laboratory mice. Protect your skin by washing with soap and water.

Your vehicle is equipped with an Intelligent Oil Life Monitor™ that calculates the proper oil change service interval. When the information display indicates: OIL CHANGE REQUIRED, change the engine oil and oil filter. See the Information Displays chapter in the Owner's Manual for more information.

The engine oil filter protects your engine by filtering harmful, abrasive or sludge particles and particles significantly smaller than most available will-fit filters. For engine oil filter part number, See **Motorcraft Parts** (page 54).

To change the engine oil and oil filter:

1. Unscrew the oil filter and oil pan drain plug and wait for the oil to drain.
2. Replace the filter.
3. Reinstall the oil pan drain plug.
4. Refill the engine with new oil. For the proper capacity, See **Technical Specifications** (page 56).

Maintenance

5. Reset the Intelligent Oil Life Monitor™. See the Information Displays chapter in the Owner's Manual for more information.

Engine lubrication for severe service operation

The following conditions define severe operation for which engine operation with SAE 5W-40 API CJ-4 is recommended. Oil and oil filter change intervals will be determined by the Intelligent Oil Life Monitor™ as noted previously.

- Frequent or extended idling (over 10 minutes per hour of normal driving)
- Low-speed operation/stationary use
- If vehicle is operated in sustained ambient temperatures below -10°F (-23°C) or above 100°F (38°C)
- Frequent low-speed operation, consistent heavy traffic less than 25 mph (40 km/h)
- Operating in severe dust conditions
- Operating the vehicle off road
- Towing a trailer over 1,000 miles (1,600 km)
- Sustained, high-speed driving at Gross Vehicle Weight Rating (maximum loaded weight for vehicle operation)
- Use of fuels with sulfur content other than ultra-low sulfur diesel (ULSD)
- Use of high-sulfur diesel fuel

ENGINE COOLANT CHECK

Checking the Engine Coolant

The concentration and level of the engine coolant should be checked at the intervals listed in the scheduled maintenance information. See **Scheduled Maintenance** (page 58).

Note: Make sure that the level is between the MIN and MAX marks on the coolant reservoirs.

Note: Coolant expands when it is hot. The level may extend beyond the MAX mark

Note: If the level is at the MIN mark, below the MIN mark, or empty, add coolant immediately. See **Adding Engine Coolant** in this chapter.

Note: The coolant concentration should be maintained within 48% to 50%, which equates to a freeze point between -30 °F (-34 °C) and -34 °F (-37 °C).

Note: For best results, the coolant concentration should be tested with a refractometer such as Rotunda tool 300-ROB75240 available from your dealer. Ford does not recommend the use of hydrometers or coolant test strips for measuring coolant concentrations.

Note: Automotive fluids are not interchangeable. Do not use engine coolant or antifreeze or windshield washer fluid outside of its specified function and vehicle location.

Adding Engine Coolant

WARNINGS



Do not add engine coolant when the engine is hot. Steam and scalding liquids released from a hot cooling system can burn you badly. Also, you can be burned if you spill coolant on hot engine parts.



Do not put engine coolant in the windshield washer fluid container. If sprayed on the windshield, engine coolant could make it difficult to see through the windshield.

Maintenance

WARNINGS



To reduce the risk of personal injury, make sure the engine is cool before unscrewing the coolant pressure relief cap. The cooling system is under pressure; steam and hot liquid can come out forcefully when the cap is loosened slightly.



Do not add coolant further than the MAX mark.

Note: Do not use stop leak pellets, cooling system sealants, or additives as they can cause damage to the engine cooling or heating systems. This damage would not be covered under your vehicle's warranty.

Note: During normal vehicle operation, the engine coolant may change color from orange to pink or light red. As long as the engine coolant is clear and uncontaminated, this color change does not indicate the engine coolant has degraded nor does it require the engine coolant to be drained, the system to be flushed, or the engine coolant to be replaced.

- Do not mix different colors or types of coolant in your vehicle. Make sure the correct coolant is used. Mixing of engine coolants may harm your engine's cooling system. The use of an improper coolant may harm engine and cooling system components and may void the warranty. Use engine coolant meeting the Ford specification. See **Capacities and Specifications** (page 54).
- In case of emergency, a large amount of water without engine coolant may be added in order to reach a vehicle service location. In this instance, the cooling system must be drained, chemically cleaned with Motorcraft Premium Cooling System Flush, and refilled with prediluted engine coolant as soon as possible. Water alone (without engine coolant) can cause engine damage from corrosion, overheating or freezing.
- Do not use alcohol, methanol, brine or any engine coolants mixed with alcohol or methanol antifreeze (coolant). Alcohol and other liquids can cause engine damage from overheating or freezing.
- Do not add extra inhibitors or additives to the coolant. These can be harmful and compromise the corrosion protection of the engine coolant.

Add prediluted engine coolant meeting the Ford specification (Motorcraft Orange Antifreeze/Coolant Prediluted). See **Technical Specifications** (page 56). Note: Generic coolants marketed for all makes and models may not meet the Ford specification and may cause damage to the cooling system. This damage may void the warranty.

Maintenance

For vehicles with overflow coolant systems with a non-pressurized cap on the coolant recovery system, add coolant to the coolant recovery reservoir when the engine is cool. Add prediluted engine coolant (Motorcraft Orange Antifreeze/Coolant Prediluted) to the FULL COLD level. For all other vehicles which have a coolant degas system with a pressurized cap, or if it is necessary to remove the coolant pressure relief cap on the radiator of a vehicle with an overflow system, follow these steps to add engine coolant.

1. Turn the engine off and let it cool.
2. When the engine is cool, wrap a thick cloth around the coolant pressure relief cap on the coolant reservoir (a translucent plastic bottle). Slowly turn cap counterclockwise until pressure begins to release. When you are sure that all the pressure has been released, use the cloth to turn it counterclockwise and remove the cap.
3. Fill the coolant reservoir slowly with prediluted engine coolant to within the FULL COLD level, or between the MIN and MAX marks (within the COLD FILL RANGE), as listed on the engine coolant reservoir. If you removed the radiator cap in an overflow system, fill the radiator until the coolant is visible and radiator is almost full. If coolant is added to bring the level within the COLD FILL RANGE when the engine is not cold, the system may remain under filled.
4. Replace the cap. Turn until tightly installed. Cap must be tightly installed to prevent coolant loss.

Whenever coolant has been added, the coolant level in the coolant reservoir should be checked the next few times you drive the vehicle. If necessary, add enough prediluted engine coolant to bring the coolant level to the proper level.

If you have to add more than 1.0 quart (1.0 liter) of engine coolant per month, have your authorized dealer check the engine cooling system. Your cooling system may have a leak. Operating an engine with a low level of coolant can result in engine overheating and possible engine damage.

Engine and Secondary Cooling System Refill Procedure

The following procedure should be used when refilling the engine or secondary cooling systems after it has been drained or become extremely low.

1. Before you remove the cap, turn the engine off and let it cool.
2. When the engine is cool, wrap a thick cloth around the cap. Slowly turn cap counterclockwise until pressure begins to release.
3. Step back while the pressure releases.
4. When you are sure that all the pressure has been released, use the cloth to turn it counterclockwise and remove the cap.
5. Slowly add prediluted engine coolant to the coolant reservoir until the coolant level is within the COLD FILL RANGE as listed on the reservoir.
6. Reinstall the pressure relief cap.
7. Start and run the engine at 2000 rpm for 2 minutes.
8. Shut engine off, and remove the pressure relief cap as previously outlined.
9. If required, add prediluted engine coolant to the coolant reservoir until the coolant level is within the COLD FILL RANGE as listed on the reservoir.

Maintenance

10. **Engine cooling system:** Repeat Step 5 until the coolant level has stabilized (is no longer dropping after each step) AND the upper radiator hose at the radiator is warm to the touch (indicating that the engine thermostat is open and coolant is flowing through the radiator).
Secondary cooling system: Repeat Step 5 until the coolant level has stabilized (is no longer dropping after each step) AND the lower passenger side of the secondary radiator is warm to the touch (indicating secondary thermostat is open and coolant is flowing through the entire system).
11. Reinstall the pressure relief cap. Shut the engine off and let it cool.
12. Check the coolant level in the reservoir before you drive your vehicle the next few times (with the engine cool).
13. If necessary, add prediluted engine coolant to the coolant reservoir until the coolant level is within the COLD FILL RANGE as listed on the reservoir. After any coolant has been added, check the coolant concentration. See **Adding Engine Coolant** earlier in the chapter for more information.

Whenever coolant has been added, the coolant level in the reservoir should be checked the next few times you drive the vehicle. If needed, add prediluted engine coolant to bring the coolant level to the proper level on the reservoir.

Recycled Engine Coolant

Ford Motor Company does not recommend the use of recycled engine coolant since a Ford-approved recycling process is not yet available.

Used engine coolant should be disposed of in an appropriate manner. Follow your community's regulations and standards for recycling and disposing of automotive fluids.

Severe Climates

If you drive in extremely cold climates:

- It may be necessary to have a Ford authorized dealer increase the coolant concentration above 50%.
- A coolant concentration of 60% will provide improved freeze point protection. Engine coolant concentrations above 60% will decrease the overheat protection characteristics of the engine coolant and may cause engine damage.

If you drive in extremely hot climates:

- It may be necessary to have a Ford authorized dealer decrease the coolant concentration to 40%.
- A coolant concentration of 40% will provide improved overheat protection. Engine coolant concentrations below 40% will decrease the corrosion/freeze protection characteristics of the engine coolant and may cause engine damage.

Vehicles driven year-round in non-extreme climates should use prediluted engine coolant for optimum cooling system and engine protection.

Checking Coolant Corrosion Inhibitor Additive Strength

At specific mileage intervals of 15000 miles (24000 km), as listed in the scheduled maintenance information chapter, the coolant corrosion inhibitor additive should be checked. The optional information display, if equipped, will also display the message CHECK COOLANT ADDITIVE at this time. The purpose of checking is to verify the correct engine

Maintenance

coolant concentration (freeze point protection) and corrosion inhibitor additive level (strength) of the coolant for maximum engine performance and protection. Three products are available to confirm the life and health of the coolant: one tool, a test kit and a coolant inhibitor additive:

- **Rotunda tool 300–ROB75240** available from your dealer – recommended refractometer to test coolant concentration.
- **Rotunda 328-R071–ELC (Antifreeze Coolant ELC Contamination Kit)** – Evaluates the corrosion inhibitor additive strength. Note the first step is to verify the vehicle's coolant concentration is in the correct range of 40 – 60%. Coolant concentrations outside this range will not provide valid test results. If the report results in a pass (i.e., the cooling system does not show excessive contamination/the corrosion inhibitor additive strength is sufficient), no action is required. If the report results as insufficient (does not pass), the corrosion inhibitor additive strength of the coolant is too low. If the ENGINE COOLING SYSTEM corrosion inhibitor additive strength is low, add 48 fluid oz. of Motorcraft Specialty Orange Engine Coolant Revitalizer. If the SECONDARY COOLING SYSTEM corrosion inhibitor additive strength is low, add 16 fluid oz. of Motorcraft Specialty Orange Engine Coolant Revitalizer.
- **Motorcraft Specialty Orange Engine Coolant Revitalizer** – Additive to boost the corrosion inhibitor level based upon the test results of the Antifreeze Coolant ELC Contamination Kit. The Revitalizer may be added two times over the life of the coolant. If additional dosages are required, the cooling system must be flushed and refilled per the instructions in the Workshop Manual.

See **Capacities and Specifications** (page 54). for the proper coolant and additive specifications.

Maintenance

Coolant Change

At specific mileage intervals, as listed in the scheduled maintenance information, the coolant should be changed. The optional information display, if equipped, will also display the message COOLANT CHANGE REQUIRED at this time.

See **Capacities and Specifications** (page 54). for the proper coolant.

Engine-driven Cooling Fan (Fan Clutch)

Your vehicle is equipped with an engine driven cooling fan drive (also called a fan clutch). This fan drive changes the fan speed to match the vehicle's changing cooling air flow requirements. Fan speed, fan noise level and fuel consumption all will increase based on the driving conditions that include trailer towing, hill climbing, heavy loads, high speed and high ambient temperature, individually or in combination.

The fan drive is designed to provide the minimum fan speed (and resulting minimum fan noise and fuel consumption) required to meet the ever changing vehicle cooling air flow requirements. You will hear the amount of fan noise increasing and decreasing as the engine power requirements and vehicle driving conditions change as you drive. This is to be expected as being normal to the operation of your vehicle. High levels of fan noise might also be heard when your engine is first started, and should normally decrease after driving for a short time.

CHANGING THE ENGINE AIR FILTER

Air Filter Restriction Gauge

WARNING



To reduce the risk of vehicle damage and/or personal burn injuries do not start your engine with the air filter removed and do not remove it while the engine is running.

Note: *Vehicle operation in heavy snowfall or extreme rain conditions may feed excessive amounts of snow/water into the air intake system. This could plug/soak the air filter with snow and may cause the engine to lose power and possibly shut down.*



E163372

The restriction gauge, located on the upper housing of the air filter assembly, measures the vacuum inside the air filter. The more the air filter is restricted (dirty, clogged), the higher the vacuum reading

Check the air filter restriction gauge whenever the hood is raised to perform general engine maintenance at least every 7,500 miles (12,000 km). If the vehicle is operated in extremely dusty conditions, check and reset the gauge at least every 500 miles (800 km), or two weeks,

Maintenance

whichever comes first. Change the air filter when the gauge reads near the **change filter** line and the chamber is filled with yellow. Engine performance and fuel economy are adversely affected when the maximum restriction is reached.

Note: *Blowing-out the air filter element with compressed air is not recommended as the compressed air may damage the filter paper.*

Note: *It is not possible to determine the level of filter clogging by visual appearance alone. A filter which appears to be dirty may actually have several thousand miles (kilometers) of life remaining.*



E163373

After installation of the new filter element, reset the gauge by pressing the reset button on top of the gauge.

The following actions are recommended after operating the vehicle up to 200 miles (320 km) in heavy snowfall or extreme rain:

- Snow: At the earliest opportunity, open the hood and clear all the snow and ice from the air filter housing inlet (do NOT remove the foam filter) and reset the air filter restriction gauge.
- Extreme rain: The air filter will dry after about 15–30 minutes at highway speeds. At the earliest opportunity, open the hood and reset the air filter restriction gauge.

Air Filter Replacement

When replacing the air filter element, use a Motorcraft® air filter element. See **Motorcraft Parts** (page 54).

Note: *Failure to use the correct air filter element may result in severe engine damage.*

Maintenance



E163374

1. Locate the mass air flow sensor electrical connector on the air inlet tube. This connector will need to be unplugged. Unlock the locking clip on the connector, then squeeze and pull the connector off of the air inlet tube.
2. Release the four clamps that secure the cover to the air filter housing. Push the air filter cover forward (away from you) and up slightly to release it.
3. Remove the air filter element from the air filter housing.



E163375



E163376

Maintenance

4. Remove and install a new foam filter if needed according to the service interval indicated in the scheduled maintenance information in this guide. If the foam filter is not being replaced, be sure the existing foam filter is in place.

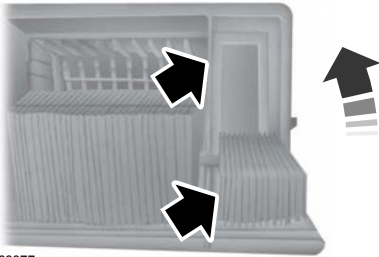

E163377

5. Install a new air filter element. Be sure that the groove seal on the pleated paper filter traps both sides of the vertical partition of the air box.

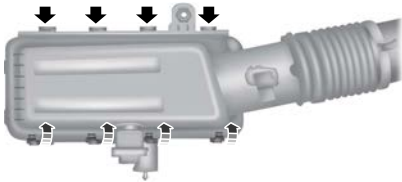

E163378

6. Replace the air filter housing cover and secure the clamps. Be careful not to crimp the filter element edges between the air filter housing and cover and ensure that the tabs on the edge are properly aligned into the slots.
7. Reconnect the mass air flow sensor electrical connector to the inlet tube. Make sure the locking tab on the connector is in the “locked” position.

Air Purge Procedure

Turn the key on for 30 seconds, then turn off. Repeat the procedure six times.

Vehicle Care

CLEANING THE ENGINE

Engines are more efficient when they are clean because grease and dirt buildup keep the engine warmer than normal.

When washing:

- Take care when using a power washer to clean the engine. The high-pressure fluid could penetrate the sealed parts and cause damage.
- Do not spray a hot engine with cold water to avoid cracking the engine block or other engine components.
- Spray Motorcraft Engine Shampoo and Degreaser on all parts that require cleaning and pressure rinse clean. In Canada, use Motorcraft Engine Shampoo.
- Never wash or rinse the engine while it is hot or running; water in the running engine may cause internal damage.
- Never wash or rinse any ignition coil, spark plug wire or spark plug well, or the area in and around these locations.
- Cover the battery, power distribution box, and air filter assembly to prevent water damage when cleaning the engine.

CLEANING THE EXHAUST

WARNINGS

 Failure to maintain the functional holes, in the tailpipe section of the exhaust, clean and free of debris or foreign material may result in the holes becoming blocked or plugged. Do not modify or remove the tail-pipe section. Blocked or plugged holes or removal/modification of the system could result in elevated exhaust gas temperatures which may result in vehicle/property damage or personal injury.

WARNINGS



The normal operating temperature of the exhaust system is very high. Never work around or attempt to repair any part of the exhaust system until it has cooled. Use special care when working around the diesel oxidation catalytic converter and/or the diesel particulate filter (DPF). The diesel oxidation catalytic converter and/or the DPF heats up to a high temperature after only a short period of engine operation and can stay hot even after the engine is turned off. Failure to follow these instructions may result in personal injury.

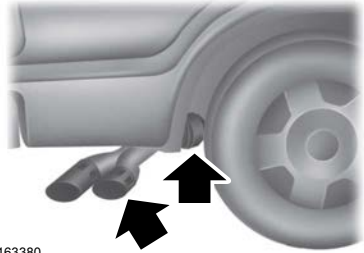

E163380

The visible holes in the exhaust tip and the holes under the shield just inboard of the right rear tire(s) are functional. The holes need to be kept clear of mud/debris or foreign material to maintain proper function of the exhaust system. Clean and remove debris or foreign material if present as needed. Spraying with a hose during regular washing of vehicle should help keep holes clean and clear of debris or foreign material.

Capacities and Specifications

ENGINE SPECIFICATIONS

Drivebelt Routing

Single Alternator

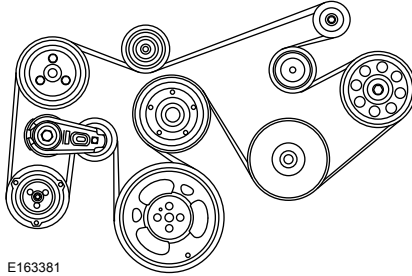

E163381

Dual Alternator

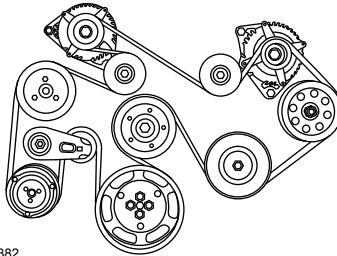

E163382

MOTORCRAFT PARTS

Component	Ford Part Number
Engine oil filter	FL-2051
Foam pre-filter	FA-1907
Air filter ¹	FA-1902

Capacities and Specifications

Component	Ford Part Number
Fuel filter kit (2 included - engine and frame rail mounted)	FD-4615
Battery (2 Required)	BXT-65-750

¹ Failure to use the correct air filter element may result in severe engine damage. The customer warranty may be void for any damage to the engine if the correct air filter element is not used.

Capacities and Specifications

TECHNICAL SPECIFICATIONS

Item	Capacity	Ford part name or equivalent	Ford part number / Ford specification
Engine coolant (primary high-temperature cooling system loop) ¹	29.4 quarts (27.8L)	Motorcraft Orange Antifreeze/Coolant Prediluted	VC-3DIL-B (US) CVC-3DIL-B (Canada) / WSS-M97B44-D2
Engine coolant additive (primary high-temperature cooling system loop)	48.0 fl. oz. (1.4L) per addition if required	Motorcraft Specialty Orange Engine Coolant Revitalizer	VC-12 / —
Engine coolant additive (secondary cooling system)	16 fl. oz. (473 mL) per addition if required		
Engine coolant (secondary cooling system) ¹	11.7 quarts (11.1L)	Motorcraft Orange Antifreeze/Coolant Prediluted	VC-3DIL-B (US) CVC-3DIL-B (Canada) / WSS-M97B44-D2
Engine oil (includes filter change)	13.0 quarts (12.4L)	Motorcraft Motor Oil SAE 10W30 Super Duty Motorcraft Motor Oil SAE 15W40 Super Duty Motorcraft Motor Oil SAE 5W40 Full Synthetic Diesel Motor Oil Motorcraft Motor Oil SAE 0W40 Full Synthetic Diesel Motor Oil	XO-10W30-QSD / WSS-M2C171-E XO-15W40-QSD / WSS-M2C171-E XO-5W40-5QSD / WSS-M2C171-E XO-0W40-DAS / WSS-M2C171-E
Diesel Exhaust Fluid (DEF) — Pick-up	5 gallons (18.9L)	Motorcraft Diesel Exhaust Fluid	PM-27-GAL/PM-27-JUG / WSS-M99C130-A
Diesel Exhaust Fluid — Chassis Cab	6 gallons (22.7L)		
Cetane Booster & Performance Improver	—	Motorcraft Cetane Booster & Performance Improver	PM-22-A (US) PM-22-B (Canada) / —

Capacities and Specifications

Item	Capacity	Ford part name or equivalent	Ford part number / Ford specification
Anti-Gel & Performance Improver	—	Motorcraft Anti-Gel & Performance Improver	PM-23-A (US) PM-23-B (Canada) / —
Automatic transmission fluid	Refer to Owner's Manual		
Fuel tank — Pick up regular cab long box and all short box	26 gallons (98.4L)	—	—
Fuel tank — Pick Up long box (except regular cab)	37.5 gallons (142.0L)	—	—
Fuel tank — Chassis cab (midship)	28 gallons (106.0L)	—	—
Fuel tank — Chassis cab (aft of axle)	40 gallons (151.4L)	—	—
Fuel tank — Dual tanks	40 gallon (151.4L) and 28 gallon (106.0L)	—	—

¹Use the coolant type originally equipped in your vehicle. Using any other coolant may result in vehicle damage.

Scheduled Maintenance

GENERAL MAINTENANCE INFORMATION

Why Maintain Your Vehicle?

Carefully following the maintenance schedule helps protect against major repair expenses resulting from neglect or inadequate maintenance and may help to increase the value of your vehicle when you sell or trade it. Keep all receipts for completed maintenance with your vehicle.

We have established regular maintenance intervals for your vehicle based upon rigorous testing. It is important that you have your vehicle serviced at the proper times. These intervals serve two purposes; one is to maintain the reliability of your vehicle and the second is to keep your cost of owning your vehicle down.

It is your responsibility to have all scheduled maintenance performed and to make sure that the materials used meet the specifications identified in the owner's manual.

Failure to perform scheduled maintenance invalidates warranty coverage on parts affected by the lack of maintenance.

Why Maintain Your Vehicle at Your Dealership?

Factory-trained Technicians

Service technicians participate in extensive factory-sponsored certification training to help them become experts on the operation of your vehicle. Ask your dealership about the training and certification their technicians have received.

Genuine Ford and Motorcraft Replacement Parts

Dealerships stock Ford, Motorcraft and Ford-authorized branded re-manufactured replacement parts. These parts meet or exceed our specifications. Parts installed at your dealership carry a nationwide 12-month or 12000-mile (20000 kilometer) parts and labor limited warranty.

If you do not use Ford authorized parts they may not meet our specifications and depending on the part, it could affect emissions compliance.

Convenience

Many dealerships have extended evening and Saturday hours to make your service visit more convenient and they offer one stop shopping. They can perform any services that are required on your vehicle, from general maintenance to collision repairs.

Note: *Not all dealers have extended hours or body shops. Please contact your dealer for details.*

Protecting Your Investment

Maintenance is an investment that pays dividends in the form of improved reliability, durability and resale value. To maintain the proper performance of your vehicle and its emission control systems, make sure you have scheduled maintenance performed at the designated intervals.

Your vehicle is very sophisticated and built with multiple, complex, performance systems. Every manufacturer develops these systems using different specifications and performance features. That is why it is important to rely upon your dealership to properly diagnose and repair your vehicle.

Scheduled Maintenance

Ford Motor Company has recommended maintenance intervals for various parts and component systems based upon engineering testing. Ford Motor Company relies upon this testing to determine the most appropriate mileage for replacement of oils and fluids to protect your vehicle at the lowest overall cost to you and recommends against maintenance schedules that deviate from the scheduled maintenance information.

We strongly recommend the use of only genuine Ford, Motorcraft or Ford-authorized re-manufactured replacement parts engineered for your vehicle.

Additives and Chemicals

This owner's manual and the Ford Workshop Manual list the recommended additives and chemicals for your vehicle. We do not recommend using chemicals or additives not approved by us as part of your vehicle's normal maintenance. Please consult your warranty information.

Oils, Fluids and Flushing

In many cases, fluid discoloration is a normal operating characteristic and, by itself, does not necessarily indicate a concern or that the fluid needs to be changed. However, a qualified expert, such as the factory-trained technicians at your dealership, should inspect discolored fluids that also show signs of overheating or foreign material contamination immediately.

Make sure to change your vehicle's oils and fluids at the specified intervals or in conjunction with a repair. Flushing is a viable way to change fluid for many vehicle sub-systems during scheduled maintenance. It is critical that systems are flushed only with new fluid that is the same as that required to fill and operate the system or using a Ford-approved flushing chemical.

Owner Checks and Services

Make sure you perform the following basic maintenance checks and inspections every month or at six-month intervals.

Check every month
Air filter restriction gauge.
Fuel and water separator. Drain if necessary (or if indicated by the information display).
Tires (including spare) for wear and proper pressure.
Holes and slots in the tail pipe to make sure they are functional and clear of debris.

Scheduled Maintenance

Tightening lug nuts	
Vehicles with single rear wheels	Tighten the lug nuts to the specified torque at 500 miles (800 km) after any wheel disturbance (such as tire rotation, changing a flat tire or wheel removal).
Vehicles with dual rear wheels	Tighten the wheel lug nuts to the specified torque at 100 miles (160 km), and again at 500 miles (800 km) of new vehicle operation and after any wheel disturbance (such as tire rotation, changing a flat tire or wheel removal).

Note: For the proper lug nut torque specification, see *Technical specifications in the Wheels and Tires chapter of your owner's manual.*

Multi-point Inspection

In order to keep your vehicle running right, it is important to have the systems on your vehicle checked regularly. This can help identify potential issues and prevent major problems. We recommend having the following multi-point inspection performed at every scheduled maintenance interval to help make sure your vehicle keeps running great.

Multi-point inspection	
Accessory drive belt(s)	Horn operation
Battery performance	Radiator, cooler, heater and A/C hoses
Engine air filter	Suspension component for leaks or damage
Exhaust system	Steering and linkage
Exterior lamps and hazard warning system operation	Tires (including spare) for wear and proper pressure**
Fluid levels*; fill if necessary	Windshield for cracks, chips or pits
For oil and fluid leaks	Washer spray and wiper operation

* Brake, coolant recovery reservoir, automatic transmission, power steering and window washer.

**If your vehicle is equipped with a temporary mobility kit, check the tire sealant expiration Use By date on the canister. Replace as needed.

Scheduled Maintenance

Be sure to ask your dealership service advisor or technician about the multi-point vehicle inspection. It is a comprehensive way to perform a thorough inspection of your vehicle. Your checklist gives you immediate feedback on the overall condition of your vehicle.

NORMAL SCHEDULED MAINTENANCE

Intelligent Oil-Life Monitor

Your vehicle is equipped with an Intelligent Oil-Life Monitor that determines when you should change the engine oil based on how your vehicle is used. By using several important factors in its calculations, the monitor helps reduce the cost of owning your vehicle and reduces environmental waste at the same time.

This means you do not have to remember to change the oil on a mileage-based schedule. Your vehicle lets you know when an oil change is due by displaying **ENGINE OIL CHANGE DUE** or **OIL CHANGE REQUIRED** in the information display.

The following table provides examples of vehicle use and its impact on oil change intervals. It is a guideline only. Actual oil change intervals depend on several factors and generally decrease with severity of use.

When to expect the OIL CHANGE REQUIRED message	
Miles (km)	Vehicle use and example
7500-10000 (12000-16000)	Normal
	Normal commuting with highway driving No, or moderate, load or towing Flat to moderately hilly roads No extended idling
5000-7499 (8000-11999)	Severe
	Moderate to heavy load or towing Mountainous or off-road conditions Extended idling Extended hot or cold operation
3000-4999 (4000-7999)	Extreme
	Maximum load or towing Extreme hot or cold operation Use of high sulfur diesel fuel

Note: Use the appropriate special operating condition for maintenance information when using high sulfur diesel fuels, operating your vehicle off-road or in dusty conditions (such as unpaved roads).

Scheduled Maintenance

Normal Maintenance Intervals

At every oil change interval as indicated by the information display¹
Change the engine oil and filter. ²
Refill the diesel exhaust fluid tank.
Rotate the tires ³ , inspect the tires for wear and measure tread depth.
Perform a multi-point inspection (recommended).
Inspect the air filter restriction gauge. Replace the filter if necessary.
Inspect the automatic transmission fluid level. Consult your dealer for requirements.
Inspect the brake pads, shoes, rotors, drums, brake linings, hoses and parking brake.
Inspect the engine and secondary coolant level and hoses.
Inspect the exhaust system and heat shields.
Inspect the front axle and U-joints. Lubricate any grease fittings. (Four-wheel drive vehicles)
Inspect the steering linkage, ball joints, suspension, tie-rod ends, driveshaft and U-joints. Lubricate any grease fittings.

¹ Do not exceed one year or 10000 miles (16000 kilometers) between service intervals.

² Reset the Intelligent Oil-Life Monitor after engine oil and filter changes.

³ Vehicles with dual rear wheels should rotate the front wheels when specified; rear wheels only if unusual wear is noted.

Other maintenance items¹	
Every 15000 miles (24000 km)	Inspect the engine and secondary cooling system concentration (freeze-point protection), additive (corrosion inhibitor) strength, coolant level and hoses. ²
Every 22500 miles (36000 km)	Replace the engine-mounted and frame-mounted fuel filters. ³
Every 30000 miles (48000 km)	Replace the climate-controlled (heated and cooled) seat filter. ⁴
Every 45000 miles (72000 km)	Replace the air inlet foam filter.

Scheduled Maintenance

Other maintenance items¹	
Every 60000 miles (96000 km)	Replace the front wheel bearing grease and grease seal if using non-sealed bearings. (Two-wheel drive vehicles)
At 90000 miles (144000 km)	Inspect the accessory drive belt(s). ⁵
At 100000 miles (160000 km)	Change the rear axle fluid (Dana axles. See Special operating conditions). ⁶
Every 105000 miles (168000 km)	Change the engine coolant and secondary coolant. ⁷
Every 150000 miles (240000 km)	Change the automatic transmission fluid and filter. Consult an authorized dealer for requirements.
	Change the front axle fluid. (Four-wheel drive vehicles)
	Change transfer case fluid. (Four-wheel drive vehicles)
	Replace the accessory drive belt(s) if not replaced within the last 100000 miles (160000 km).
	Replace the front wheel bearings and seals if using non-sealed bearings. (Two-wheel drive vehicles).

¹ You can perform these maintenance items within 3000 miles (4800 kilometers) of the last oil change. Do not exceed the designated distance for the interval.

² Every 15000 miles (24000 kilometers), 600 engine hours or as indicated by the information display.

³ Every 22500 miles (36000 kilometers) or as indicated by the information display.

⁴ If your vehicle has this feature.

⁵ Perform follow-up inspections every 15000 miles (24000 kilometers) after the initial inspection. Replace the belt(s) at 150000 miles (240000 kilometers).

⁶ Change the fluid again at 150000 miles (240000 kilometers).

⁷ Initial change is at six years or 105000 miles (168000 kilometers), then every three years or 45000 miles (72000 kilometers).

Scheduled Maintenance

SPECIAL OPERATING CONDITIONS SCHEDULED MAINTENANCE

If you operate your vehicle **primarily** in any of the following conditions, you need to

perform extra maintenance as indicated. If you operate your vehicle **occasionally** under any of these conditions, it is not necessary to perform the extra maintenance. For specific recommendations, see your dealership service advisor or technician.

Towing a trailer or using a car-top carrier	
As required	Change the engine oil and filter as indicated by the information display, and perform the services listed in the scheduled maintenance chart.
	See the axle maintenance items under Exceptions .
Every 15000 miles (24000 km) or 600 engine hours	Inspect the coolant concentration (freeze-point protection) and additive (corrosion inhibitor) strength. Add engine coolant additive if necessary.
Every 15000 miles (24000 km), 6 months, 600 engine hours, or as indicated by the information display	Replace the engine-mounted and frame-mounted fuel filters.
Every 30000 miles (48000 km)	Replace the wheel bearing grease and grease seals if using non-sealed bearings. (Two-wheel drive vehicles)
Every 60000 miles (96000 km)	Change the transfer case fluid. (Four-wheel drive vehicles)
Every 60000 miles (96000 km) or 2400 engine hours	Flush and refill the engine coolant. Do not add engine coolant additive.

Note: When adding coolant additive, do not exceed the specified maximum of 48 fluid ounces (1.4 liters). Operating the engine with excessive coolant additive may cause overheating which could lead to severe, permanent engine damage.

Note: After the initial coolant flush and fill at 60000 miles (96000 kilometers) or 2400 engine hours, flush and fill every 45000 miles (72000 kilometers) or 1800 engine hours thereafter.

Scheduled Maintenance

Frequent or extended idling (over 10 minutes per hour of normal driving) or frequent low-speed operation if your vehicle is used for stationary operation	
As required	Change the engine oil and filter as indicated by the information display, and perform the services listed in the scheduled maintenance chart.
Every 15000 miles (24000 km), six months, 600 engine hours, or as indicated by the information display	Replace the engine-mounted and frame-mounted fuel filters.
Every 15000 miles (24000 km) or 600 engine hours	Inspect the coolant concentration (freeze-point protection) and additive (corrosion inhibitor) strength. Add engine coolant additive if necessary.
Every 60000 miles (96000 km) or 2400 engine hours	Flush and refill the engine coolant. Do not add engine coolant additive.

Note: When adding coolant additive, do not exceed the specified maximum of 48 fluid ounces (1.4 liters). Operating the engine with excessive coolant additive may cause overheating which could lead to severe, permanent engine damage.

Note: After the initial coolant flush and fill at 60000 miles (96000 kilometers) or 2400 engine hours, flush and fill every 45000 miles (72000 kilometers) or 1800 engine hours thereafter.

Frequent low-speed operation, consistent heavy traffic under 25 mph (40 km/h) or long rush-hour traffic	
As required	Change the engine oil and filter as indicated by the information display, and perform the services listed in the scheduled maintenance chart.
Every 15000 miles (24000 km), six months, 600 engine hours, or as indicated by the information display	Replace the engine-mounted and frame-mounted fuel filters.
Every 15000 miles (24000 km) or 600 engine hours	Inspect the coolant concentration (freeze-point protection) and additive (corrosion inhibitor) strength. Add engine coolant additive if necessary.

Scheduled Maintenance

Frequent low-speed operation, consistent heavy traffic under 25 mph (40 km/h) or long rush-hour traffic	
Every 60000 miles (96000 km)	Change the transfer case fluid. (Four-wheel drive vehicles)
Every 60000 miles (96000 km) or 2400 engine hours	Flush and refill the engine coolant. Do not add engine coolant additive.

Note: When adding coolant additive, do not exceed the specified maximum of 48 fluid ounces (1.4 liters). Operating the engine with excessive coolant additive may cause overheating which could lead to severe, permanent engine damage.

Note: After the initial coolant flush and fill at 60000 miles (96000 kilometers) or 2400 engine hours, flush and fill every 45000 miles (72000 kilometers) or 1800 engine hours thereafter.

Sustained high-speed driving at gross vehicle weight rating (maximum loaded weight for vehicle operation)	
As required	Change the engine oil and filter as indicated by the information display, and perform the services listed in the scheduled maintenance chart.
Every 15000 miles (24000 km), six months, 600 engine hours, or as indicated by the information display	Replace the engine-mounted and frame-mounted fuel filters.
Every 15000 miles (24000 km) or 600 engine hours	Inspect the coolant concentration (freeze-point protection) and additive (corrosion inhibitor) strength. Add engine coolant additive if necessary.
Every 30000 miles (48000 km)	Replace the wheel bearing grease and grease seals if using non-sealed bearings. (Two-wheel drive vehicles)
Every 50000 miles (80000 km)	Change the rear axle fluid (Dana rear axles only - some F-350s; all F-450s and F-550s).
	Change the transfer case fluid. (Four-wheel drive vehicles)
Every 60000 miles (96000 km) or 2400 engine hours	Flush and refill the engine coolant. Do not add engine coolant additive.

Note: When adding coolant additive, do not exceed the specified maximum of 48 fluid ounces (1.4 liters). Operating the engine with excessive coolant additive may cause overheating which could lead to severe, permanent engine damage.

Note: After the initial coolant flush and fill at 60000 miles (96000 kilometers) or 2400 engine hours, flush and fill every 45000 miles (72000 kilometers) or 1800 engine hours thereafter.

Scheduled Maintenance

Operating in sustained ambient temperatures below -10°F (-23°C) or above 100°F (38°C)	
As required	Change the engine oil and filter as indicated by the information display, and perform the services listed in the scheduled maintenance chart.
Every 15000 miles (24000 km), six months, 600 engine hours, or as indicated by the information display	Replace the engine-mounted and frame-mounted fuel filters.
Every 30000 miles (48000 km)	Replace the wheel bearing grease and grease seals if using non-sealed bearings. (Two-wheel drive vehicles)
Every 60000 miles (96000 km)	Change the transfer case fluid. (Four-wheel drive vehicles)

Operating in dusty or sandy conditions (such as unpaved or dusty roads)	
Every 7500 miles (12000 km)	Rotate the tires*, inspect the tires for wear and measure tread depth.
	Inspect the brake system pads and rotors.
	Inspect the air filter restriction gauge. Replace the filter if necessary.
	Inspect the steering and suspension ball joints and tie rods. Lubricate any grease fittings.
Every 7500 miles (12000 km), six months or 300 engine hours	Change the engine oil and filter.**
	Inspect and lubricate the U-joints.
Every 15000 miles (24000 km), six months, 600 engine hours, or as indicated by the information display	Replace the engine-mounted and frame-mounted fuel filters.
Every 30000 miles (48000 km)	Replace the air inlet foam filter.
	Replace the wheel bearing grease and grease seals if using non-sealed bearings. (Two-wheel drive vehicles)

*Vehicles with dual rear wheels should rotate the front wheels when specified; rear wheels only if unusual wear is noted.

**Reset the Intelligent Oil-Life Monitor after engine oil and filter changes.

Scheduled Maintenance

Off-road operation	
As required	Inspect functional holes in each leg of the twin exhaust tips and the holes under the shield just inboard of the right rear tire to make sure they are clean and clear of debris or foreign materials. Refer to the Vehicle Care chapter of your owner's manual for more information.
	Inspect the steering and suspension ball joints and tie rods. Lubricate any grease fittings.
Every 7500 miles (12000 km), six months or 300 engine hours	Rotate the tires*, inspect the tires for wear and measure tread depth.
	Inspect the brake system pads and rotors.
	Inspect the air filter restriction gauge. Replace the filter if necessary.
Every 7500 miles (12000 km) or 300 engine hours	Change the engine oil and filter.**
Every 15000 miles (24000 km), six months, 600 engine hours, or as indicated by the information display	Replace the engine-mounted and frame-mounted fuel filters.
Every 30000 miles (48000 km)	Replace the air inlet foam filter.
	Replace the wheel bearing grease and grease seals if using non-sealed bearings. (Two-wheel drive vehicles).
Every 50000 miles (80000 km)	Change the rear axle fluid (Dana rear axles only - some F-350s; all F-450s and F-550s).
	Change the transfer case fluid. (Four-wheel drive vehicles)
	Inspect the front axle fluid. (Four-wheel drive vehicles)

*Vehicles with dual rear wheels should rotate the front wheels when specified; rear wheels only if unusual wear is noted.

**Reset the Intelligent Oil-Life Monitor after engine oil and filter changes.

Scheduled Maintenance

Using biodiesel, up to and including 20% biodiesel (B20)	
As required	Change the engine oil and filter as indicated by the information display, and perform the services listed in the scheduled maintenance chart.
Every 15000 miles (24000 km), six months, 600 engine hours, or as indicated by the information display	Replace the engine-mounted and frame-mounted fuel filters.

Using fuel other than ultra-low sulfur diesel fuel - vehicles operated where ultra-low sulfur diesel fuel is not required or available	
Every 2500 miles (4000 km) or three months (if using high sulfur fuel with more than 500 ppm sulfur)	Change engine oil and filter.
Every 5000 miles (8000 km) or six months (if using high sulfur fuel with fewer than 500 ppm sulfur)	Change engine oil and filter.

Exceptions

There are several exceptions to the Normal Schedule:

Normal vehicle axle maintenance: Rear axles and power take-off units with synthetic fluid and light-duty trucks equipped with Ford-design axles are lubricated for life; do not check or change fluid unless a leak is suspected, service is required or the assembly has been submerged in water. During long periods of trailer towing with outside temperatures above 70°F (21°C) and at wide-open throttle for long periods above 45 mph (72 km/h), change non-synthetic rear axle fluid every 3000 miles (4800 kilometers) or three months, whichever comes first. This interval can be waived if the axle is filled

with 75W140 synthetic gear fluid meeting Ford specification WSL-M2C192-A, part number FITZ-19580-B, or equivalent. Add friction modifier XL-3 (EST-M2C118-A) or equivalent for complete refill of Traction-Lok rear axles.

F-450 and F-550 axle maintenance: Change rear axle fluid every 100000 miles (160000 kilometers) under normal driving conditions on all commercial applications. When operating your vehicle at or near maximum Gross Vehicle Weights, change the rear axle fluid every 50000 miles (80000 kilometers). In addition, follow this 50000-mile (80000 kilometer) schedule when operating your vehicle under the special operating conditions, where noted.

Scheduled Maintenance

Diesel Particulate Filter: The filter may need to be removed for ash cleaning at approximately 120000 miles (192000 kilometers) or greater (actual mileage can vary greatly depending upon engine and vehicle operating conditions) and replaced with a new or remanufactured (ash cleaned) part. The filter may need to be replaced at approximately 250000 miles (400000 kilometers) depending upon

engine and vehicle operating conditions. In both cases, the engine control system sets a service light (wrench icon) to inform you to bring your vehicle to the dealer for service. If there are any issues with the oxidation catalyst or particulate filter system, a service light (wrench or engine icon) sets by the engine control system to inform you to bring your vehicle into a dealer for service.

SCHEDULED MAINTENANCE RECORD

<input type="radio"/> Repair Order #:	Dealer stamp
<input type="radio"/> Distance:	
<input type="radio"/> Engine hours (optional):	
<input type="radio"/> Multi-point inspection (recommended): <input type="checkbox"/>	
<input type="radio"/> Signature:	

<input type="radio"/> Repair Order #:	Dealer stamp
<input type="radio"/> Distance:	
<input type="radio"/> Engine hours (optional):	
<input type="radio"/> Multi-point inspection (recommended): <input type="checkbox"/>	
<input type="radio"/> Signature:	

Scheduled Maintenance

<input type="radio"/> Repair Order #:	<p>Dealer stamp</p>
<input type="radio"/> Distance:	
<input type="radio"/> Engine hours (optional):	
<input type="radio"/> Multi-point inspection (recommended): <input type="checkbox"/>	
<input type="radio"/> Signature:	

<input type="radio"/> Repair Order #:	<p>Dealer stamp</p>
<input type="radio"/> Distance:	
<input type="radio"/> Engine hours (optional):	
<input type="radio"/> Multi-point inspection (recommended): <input type="checkbox"/>	
<input type="radio"/> Signature:	

<input type="radio"/> Repair Order #:	<p>Dealer stamp</p>
<input type="radio"/> Distance:	
<input type="radio"/> Engine hours (optional):	
<input type="radio"/> Multi-point inspection (recommended): <input type="checkbox"/>	
<input type="radio"/> Signature:	

Scheduled Maintenance

<input type="radio"/> Repair Order #:	<p>Dealer stamp</p>
<input type="radio"/> Distance:	
<input type="radio"/> Engine hours (optional):	
<input type="radio"/> Multi-point inspection (recommended): <input type="checkbox"/>	
<input type="radio"/> Signature:	

<input type="radio"/> Repair Order #:	<p>Dealer stamp</p>
<input type="radio"/> Distance:	
<input type="radio"/> Engine hours (optional):	
<input type="radio"/> Multi-point inspection (recommended): <input type="checkbox"/>	
<input type="radio"/> Signature:	

<input type="radio"/> Repair Order #:	<p>Dealer stamp</p>
<input type="radio"/> Distance:	
<input type="radio"/> Engine hours (optional):	
<input type="radio"/> Multi-point inspection (recommended): <input type="checkbox"/>	
<input type="radio"/> Signature:	

Scheduled Maintenance

<input type="radio"/> Repair Order #:	<p>Dealer stamp</p>
<input type="radio"/> Distance:	
<input type="radio"/> Engine hours (optional):	
<input type="radio"/> Multi-point inspection (recommended): <input type="checkbox"/>	
<input type="radio"/> Signature:	

<input type="radio"/> Repair Order #:	<p>Dealer stamp</p>
<input type="radio"/> Distance:	
<input type="radio"/> Engine hours (optional):	
<input type="radio"/> Multi-point inspection (recommended): <input type="checkbox"/>	
<input type="radio"/> Signature:	

<input type="radio"/> Repair Order #:	<p>Dealer stamp</p>
<input type="radio"/> Distance:	
<input type="radio"/> Engine hours (optional):	
<input type="radio"/> Multi-point inspection (recommended): <input type="checkbox"/>	
<input type="radio"/> Signature:	

Scheduled Maintenance

<input type="radio"/> Repair Order #:	<p>Dealer stamp</p>
<input type="radio"/> Distance:	
<input type="radio"/> Engine hours (optional):	
<input type="radio"/> Multi-point inspection (recommended): <input type="checkbox"/>	
<input type="radio"/> Signature:	

<input type="radio"/> Repair Order #:	<p>Dealer stamp</p>
<input type="radio"/> Distance:	
<input type="radio"/> Engine hours (optional):	
<input type="radio"/> Multi-point inspection (recommended): <input type="checkbox"/>	
<input type="radio"/> Signature:	

<input type="radio"/> Repair Order #:	<p>Dealer stamp</p>
<input type="radio"/> Distance:	
<input type="radio"/> Engine hours (optional):	
<input type="radio"/> Multi-point inspection (recommended): <input type="checkbox"/>	
<input type="radio"/> Signature:	

Scheduled Maintenance

<input type="radio"/> Repair Order #:	<p>Dealer stamp</p>
<input type="radio"/> Distance:	
<input type="radio"/> Engine hours (optional):	
<input type="radio"/> Multi-point inspection (recommended): <input type="checkbox"/>	
<input type="radio"/> Signature:	

<input type="radio"/> Repair Order #:	<p>Dealer stamp</p>
<input type="radio"/> Distance:	
<input type="radio"/> Engine hours (optional):	
<input type="radio"/> Multi-point inspection (recommended): <input type="checkbox"/>	
<input type="radio"/> Signature:	

<input type="radio"/> Repair Order #:	<p>Dealer stamp</p>
<input type="radio"/> Distance:	
<input type="radio"/> Engine hours (optional):	
<input type="radio"/> Multi-point inspection (recommended): <input type="checkbox"/>	
<input type="radio"/> Signature:	

Scheduled Maintenance

<input type="radio"/> Repair Order #:	<p>Dealer stamp</p>
<input type="radio"/> Distance:	
<input type="radio"/> Engine hours (optional):	
<input type="radio"/> Multi-point inspection (recommended): <input type="checkbox"/>	
<input type="radio"/> Signature:	

<input type="radio"/> Repair Order #:	<p>Dealer stamp</p>
<input type="radio"/> Distance:	
<input type="radio"/> Engine hours (optional):	
<input type="radio"/> Multi-point inspection (recommended): <input type="checkbox"/>	
<input type="radio"/> Signature:	

<input type="radio"/> Repair Order #:	<p>Dealer stamp</p>
<input type="radio"/> Distance:	
<input type="radio"/> Engine hours (optional):	
<input type="radio"/> Multi-point inspection (recommended): <input type="checkbox"/>	
<input type="radio"/> Signature:	

Index

A

About This Supplement.....	3
Breaking-In Your Vehicle.....	3
Diesel Engine Information.....	3
Minor Troubleshooting Guide.....	5
Warnings.....	3
ABS	
See: Brakes.....	36

B

Brakes.....	36
General Information.....	36

C

Capacities and Specifications.....	54
Technical Specifications.....	56
Changing the Engine Air Filter.....	49
Air Filter Replacement.....	50
Air Filter Restriction Gauge.....	49
Cleaning the Engine.....	53
Cleaning the Exhaust.....	53
Coolant Check	
See: Engine Coolant Check.....	44

E

Emission Control System.....	29
Diesel Exhaust System: Oxidation Catalyst And Diesel Particulate Filter System	29
Engine Block Heater.....	13
Rapid Heat Supplemental Heating System.....	13
Engine Coolant Check.....	44
Adding Engine Coolant.....	44
Checking Coolant Corrosion Inhibitor Additive Strength	47
Checking the Engine Coolant.....	44
Coolant Change.....	49
Engine and Secondary Cooling System Refill Procedure.....	46
Engine-driven Cooling Fan (Fan Clutch).....	49
Recycled Engine Coolant.....	47
Severe Climates.....	47

Engine Idle Shutdown.....	12
Engine Oil Check.....	42
Changing the Engine Oil and Oil Filter.....	43
Engine Oil Specifications.....	42
Engine Specifications.....	54
Drivebelt Routing.....	54

F

Fuel and Refueling.....	14
Fuel Quality.....	14
Biodiesel.....	15
Diesel Fuel Additives	16
Fuel And Water Separator	16
Fuel Requirements - Choosing The Right Fuel: Vehicles Operated Where Ultra Low Sulfur Diesel Fuel Is Not Required	14
Fuel Requirements - Choosing The Right Fuel: Vehicles Operated Where Ultra Low Sulfur Diesel Fuel Is Required (United States/Canada/Puerto Rico/U.S. Virgin Islands And Other Locales)	14
Fuel Shutoff.....	38
Running Out Of DEF (Diesel Exhaust Fluid).....	38
Fuel Tank Selector Switch.....	35

G

Gauges.....	7
Engine Boost Gauge.....	7
General Maintenance Information.....	58
Multi-point Inspection.....	60
Owner Checks and Services.....	59
Protecting Your Investment.....	58
Why Maintain Your Vehicle?.....	58
Why Maintain Your Vehicle at Your Dealership?.....	58

I

Instrument Cluster.....	7
Introduction.....	3

Index

J

Jump-Starting the Vehicle.....	38
Connecting the Jumper Cables.....	39
Jump Starting.....	40
Preparing Your Vehicle.....	38
Removing the Jumper Cables.....	40

M

Maintenance.....	41
Motorcraft Parts.....	54

N

Normal Scheduled Maintenance.....	61
Intelligent Oil-Life Monitor.....	61
Normal Maintenance Intervals.....	62

O

Oil Check	
See: Engine Oil Check.....	42

R

Refueling.....	28
Fueling Tips.....	28
Roadside Emergencies.....	38

S

Scheduled Maintenance Record.....	70
Scheduled Maintenance.....	58
Selective Catalytic Reduction	
System.....	20
Diesel Exhaust Fluid warning messages and	
vehicle operations.....	20
Importance of maintaining the Diesel	
Exhaust Fluid level.....	20
Special Operating Conditions Scheduled	
Maintenance.....	64
Exceptions.....	69
Starting a Diesel Engine.....	9
Cold Weather Operation.....	10
Cold Weather Starting.....	9
Starting and Stopping the Engine.....	9
Switching Off the Engine.....	12

T

Technical Specifications	
See: Capacities and Specifications.....	54
Towing a Trailer.....	37
Towing.....	37

U

Under Hood Overview.....	41
F-Super Duty.....	41
Scheduled Maintenance.....	42

V

Vehicle Care.....	53
-------------------	----

W

Warning Lamps and Indicators.....	7
Diesel Exhaust Fluid.....	7
Glow Plug Pre-Heat.....	8
Water In Fuel.....	8

