

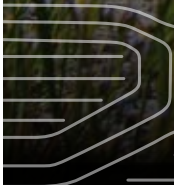

2017  1500  
**RAM**





# — AMERICA'S — LONGEST-LASTING — PICKUPS —<sup>1\*</sup>



**BEST FUEL ECONOMY OF ANY FULL-SIZE PICKUP<sup>2</sup>**

**BEST-IN-CLASS<sup>3</sup> ENTRY V6 HORSEPOWER**

► **RAM 1500. POWER, PERFORMANCE, EFFICIENCY.** From the off-road worthiness of Ram Rebel<sup>®</sup> to the sophistication of the Ram Limited, Ram 1500 delivers uncompromising comfort and superb capability—backed with a raft of best-in-class and class-exclusive features. See more at [RAMTRUCKS.COM](http://RAMTRUCKS.COM)

\*A note about this catalog: all disclaimers and disclosures can be found on page 52.

**CLASS-EXCLUSIVE<sup>3</sup> FOUR-CORNER AIR SUSPENSION SYSTEM | BEST-IN-CLASS<sup>3</sup> CARGO MANAGEMENT SYSTEM**

DEALER ePROCESS





**PREMIUM WOOD/LEATHER-WRAPPED STEERING WHEEL | PREMIUM CENTER CONSOLE WITH TAMBOUR DOOR**

► **THE LUXURY OF RAM 1500 LIMITED.** It literally has it all: Black interior with leather touches throughout, upscale Limited instrumentation with Platinum Chrome accents, and amenities that include Remote Start and Keyless Enter 'n Go™—all riding on distinctive 20-inch aluminum wheels. See more at [RAMTRUCKS.COM](http://RAMTRUCKS.COM)

**PREMIUM LEATHER INTERIOR IN BLACK | PREMIUM CLUSTER WITH 7-INCH DRIVER INFORMATION DISPLAY**





**SOME STRENGTHS YOU COUNT.  
OTHERS YOU WEIGH.**

Leadership is defined by the just-right combination of brains and brawn—and the strengths of Ram 1500 deliver everything a full-size pickup should offer. This is where powertrain availability includes breakthrough innovations like the available 3.0L EcoDiesel V6, the legendary 5.7L HEMI® V8—and the class-exclusive<sup>3</sup> standard TorqueFlite® 8-speed automatic. It's where suspension technology also achieves elite status, and where comfort and electronics are at the top of the game. For more, click over to [RAMTRUCKS.COM](http://RAMTRUCKS.COM)

**THE FRAME.** It's all no-nonsense from the get-go: high-strength steel core with eight ultra-tough crossmembers. Hydroformed tubular front frame unit, also of high-strength steel. In areas where heavy steel isn't needed, our engineers incorporated down-gauged yet stronger steel—a smart decision helping contribute to the fuel-sipping performance.

**THE BOX.** Also constructed with high-strength steel, this capable cargo area is illuminated with the CHMSL-mounted light and available rear LED Bed Lighting. Of course, what distinguishes Ram pickups is the brilliance of the available RamBox® Cargo Management System, a solution that completely changes the rules about hauling and storing.

**TOWING LEADERSHIP.** You expect superior performance—and Ram 1500 aims to deliver it. Towing is one of many critical areas. This structural rear bumper is rated for Class III towing, so right off the line, your Ram 1500 will fluently handle trailers up to 5,000 lb, when properly equipped.

Take the next step—and magnify your towing capability. The available factory-installed Class IV hitch receiver bolts directly to the high-strength steel frame, and when properly equipped, will take on trailers up to 10,620 lb. The trailer connector is easily accessible, with an adjacent lamp making night connections a breeze. All models provide a 4- and 7- pin connector as standard equipment.

# CAPABILITY IS OUR STRONGEST SUIT.

## RAM 1500. BUILT TO MASTER EVERY JOB.



**FUEL EFFICIENCY.** Your Ram 1500 was designed to endure tens of thousands of miles and countless years of service, so getting the most from every drop of fuel is vital.

Contributors to fuel efficiency include a sculpted aerodynamic body that glides through air, and available assets like wheel-to-wheel side steps and Active Grille Shutters.

But here, powertrain engineering is key. Proficient engine development includes the available 3.0L EcoDiesel V6, and the gas-powered workhorses: the 3.6L Pentastar® V6 and the legendary available 5.7L HEMI® V8, with its fuel-saving Multi-Displacement System (MDS) turning the mighty V8 into a gas-sipping 4-cylinder during highway cruising.

**COMFORT.** No matter which Ram 1500 you're choosing, occupant comfort is key. Ram delivers.

Interiors of every model reflect thoughtful and intuitive design. From window controls and door handles to the dashboard-mounted Rotary Shifter for the TorqueFlite® 8-speed automatic, all buttons and controls are driver- and passenger-friendly. Storage in every model is abundant, with an available fold-flat cargo load floor; Crew Cab models also feature convenient in-floor storage bins.

From the unique tire-tread pattern on the seats of Ram 1500 Rebel® to the premium leather interior of Ram 1500 Limited, this is where style and comfort never take a back seat.

**INNOVATION.** If our strongest suit is overall capability, innovation is where Ram 1500 keeps an ace of diamonds up its sleeve.

Ram 1500 was a pioneer in many areas of today's pickup. Among them: the class-exclusive<sup>3</sup> multilink coil spring rear suspension. The class-exclusive<sup>3</sup> available Active-Level™ Four-Corner Air Suspension System with its five-mode operation. The best-in-class<sup>3</sup> available RamBox® Cargo Management System. The introduction of the available EcoDiesel V6 powerplant.

The best way to see Ram 1500 innovation in action? Simply experience it for yourself—in a test drive.



# RAM 1500: WHERE GENIUS AND STRENGTH RUN DEEP.

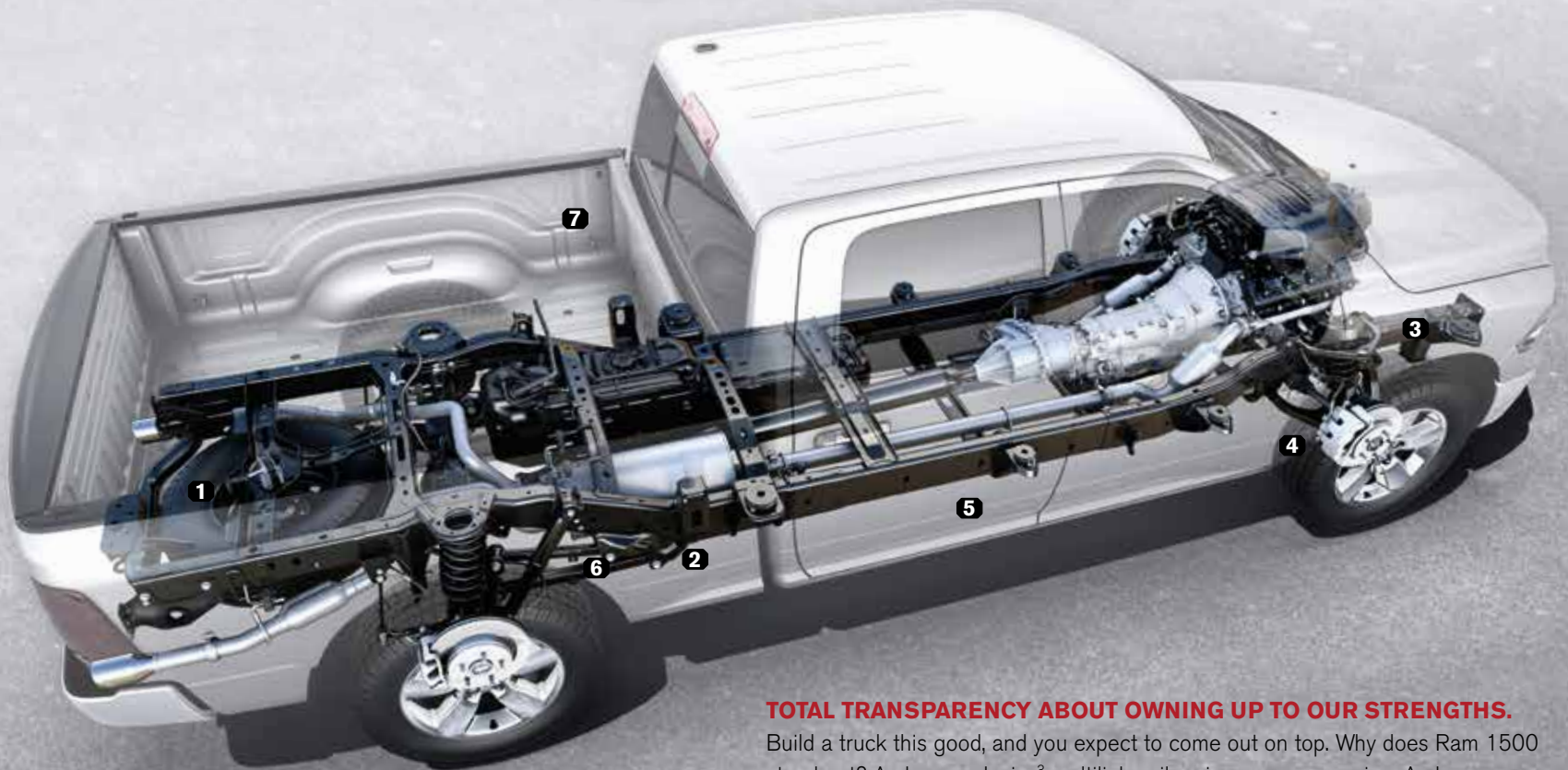

## TOTAL TRANSPARENCY ABOUT OWNING UP TO OUR STRENGTHS.

Build a truck this good, and you expect to come out on top. Why does Ram 1500 stand out? A class-exclusive<sup>3</sup> multilink coil spring rear suspension. A class-exclusive<sup>3</sup> available Active-Level™ Four-Corner Air Suspension System. A frame of advanced high-strength steel with tough crossmembers. Available Active Grille Shutters. A structural rear bumper with available factory-installed Class IV hitch receiver that bolts directly to the frame. After your review of this material, get the big picture. It's all at [RAMTRUCKS.COM](http://RAMTRUCKS.COM)

**1 THE TOW** Pulling a trailer? These numbers work: a structural rear bumper that's rated for Class III towing, built to easily handle trailers up to 5,000 lb when properly equipped. The available factory-installed Class IV hitch receiver bolts directly to the high-strength steel frame to bring the towing capability up to 10,620 lb when properly equipped.

**2 THE CLASS-EXCLUSIVE<sup>3</sup> MULTILINK COIL SPRING REAR SUSPENSION** Without exception, our competition employs leaf-spring technology. So leave it where it belongs—far behind you. The Ram 1500 employs a coil spring rear suspension that offers a degree of strength and durability the others just can't match. Count on more lateral stiffness and greater vehicle control; ride quality is so good, it's the preferred spring configuration for rail cars.

**3 THE FRONT FRAME UNIT** Working with the high-strength steel frame are eight tough crossmembers; we also employ a hydroformed tubular front frame unit, also comprised of high-strength steel. It's an ultra-stiff component that further reduces weight—helping improve fuel efficiency while providing exceptional ride characteristics.

**4 THE FRONT SUSPENSION** Your 2017 Ram 1500 utilizes proven technology: our short-/long-arm suspension with coil springs and stabilizer bar minimizes camber and toe change. You'll measure it in road manners—and in the savings that can accompany reduced tire wear.

**5 THE STEEL** Reducing weight contributes to fuel efficiency. Where heavy steel isn't required, Ram 1500 engineers opted to use down-gauged but stronger steel. Count on a full-size tough truck with weight savings that help deliver fuel-sipping performance.

**6 THE SHOCK ABSORBERS** Ram 1500 engineering leaves no stone unturned—except the ones you're riding on. These shocks are tuned for optimum ride balance, with more resistance during upward wheel motion than downward. Count on a smooth ride with reduced harshness, notably on less-than-perfect road surfaces.

**7 THE BED** In contrast with some of our competitors, all cargo beds on 2017 Ram 1500 models are constructed using tough high-strength steel, ensuring top-tier capability and confidence when hauling.



**THE CONNECTION** Connecting the trailer at night is easy: an adjacent lamp provides ample illumination. And all Ram 1500 models provide a 4- and 7-pin trailer connector, a design that accommodates virtually every trailer wiring connection out there.



**THE AERODYNAMICS** Contributing to the fuel-efficient performance and quiet ride, are exceptional aerodynamics. Wind-tunnel testing and thoroughly refined windshield shapes with aero-formed side mirrors enable Ram 1500 to glide through air.

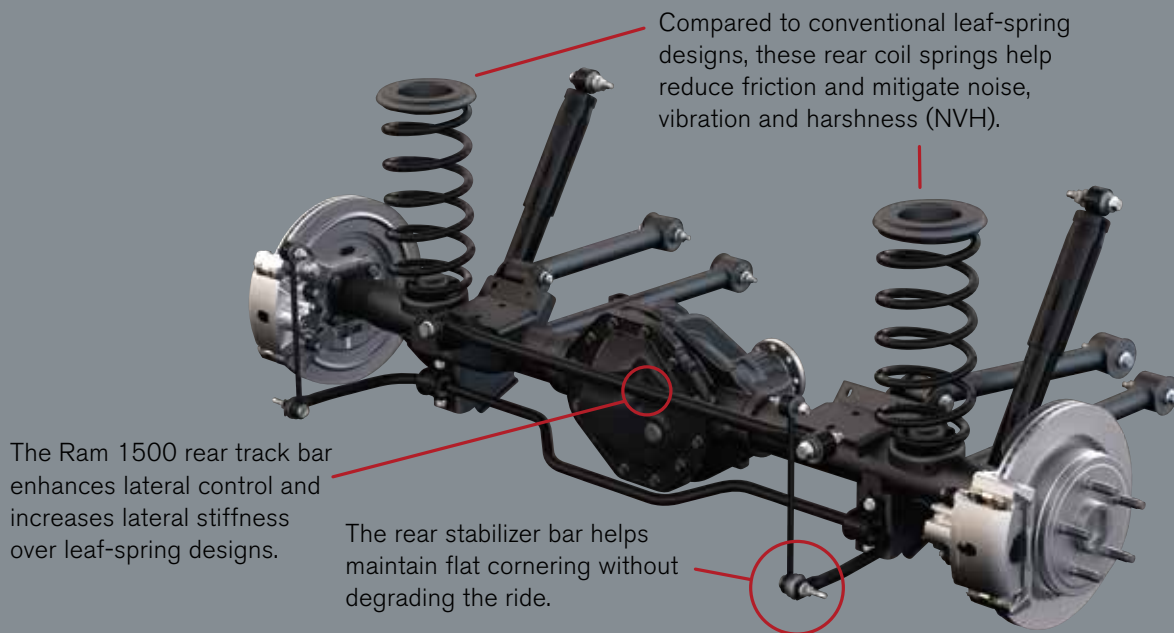

**THE ELECTRIC POWER STEERING** Advantages: parasitic losses are lower, helping improve efficiency. Operation is quieter. Speed-proportional assist ensures superb highway road feel with minimal effort in parking lots. And zero hydraulic fluid means no time or expense to monitor or replace it.



**THE ACTIVE GRILLE SHUTTERS** This available asset has proven itself beyond doubt. The shutters instantly adapt to speed, load and engine needs to provide ideal engine cooling, while significantly reducing aerodynamic drag to help improve the fuel efficiency for Ram 1500 models.





# RAM TECHNOLOGY STARTS WITH SAFETY & SECURITY.

▶ Side-Impact Door Beams  
Designed with forgiveness in mind, these door beams are engineered to absorb impact force from every angle.

▶ Dynamic Front Crumple Zones  
These crumple zones are engineered to bear the worst of any impact, helping keep cab passengers safe and secure.

▶ ParkSense® Front and Rear Park Assist<sup>5</sup>—Available

▶ Rain-Sensitive Windshield Wipers—Available

▶ Trailer Sway Damping<sup>4</sup>

▶ Rain Brake Support

▶ Hydraulic Boost Compensation

▶ Ready Alert Braking

▶ Hill Start Assist

▶ All-Speed Traction Control

▶ Antispin Rear Differential—Available

▶ Electronic Brake-Force Distribution

▶ Antilock Brake System (ABS)

▶ Auto High-Beam Headlamp Control—Available

▶ Uconnect® and SiriusXM® Travel Link<sup>6</sup> keep you in the know, with detailed weather maps and info on traffic delays and road dangers—Available





Drive a 2017 Ram 1500, where road manners, comfort and capability all ride hand in hand with safety and security. The indispensable Electronic Stability Control (ESC)<sup>4</sup> System (standard on every model) is key. The Ram 1500 ESC<sup>4</sup> System starts with these fundamental assets:

- ▶ **All-Speed Traction Control** helps regulate wheel spin. If slippage occurs during acceleration, automatic throttle control will reduce torque; in extremes (like accelerating from pavement to ice), it will apply the brakes and reduce the engine power to maintain control.
- ▶ **Trailer Sway Damping<sup>4</sup>** detects yaw and applies selective brake pressure on the tow vehicle's opposite side to counteract and reduce the sway.

The Ram 1500 braking system features optimized pedal travel to provide quick power assist. Rear wheel-speed sensors are positioned for protection against road elements. ESC<sup>4</sup> features multiple assets for braking; it even includes vehicle control when stationary. These encompass:

- ▶ **Antilock Brake System (ABS)**. Monitoring each wheel's speed, the Ram 1500 ABS design also incorporates back-up braking should one of the two braking circuits be compromised.
- ▶ **Electronic Brake-Force Distribution** regulates brake pressure from front to rear to minimize stopping distances.
- ▶ **Ready Alert Braking** senses the moment when the driver's foot is lifted from the accelerator; it applies an imperceptible brake force to ensure that pads and discs are lined up should an emergency stop be required.
- ▶ **Rain Brake Support** automatically and seamlessly activates when the driver turns on the windshield wipers; all brake calipers gently pulse against their respective rotors to remove water from the pads.
- ▶ **Hydraulic Boost Compensation**. Should a failure occur in the vacuum brake booster or any related line (e.g., a rupture from tough off-roading), the brake controller will run the ABS pump; our system is so sophisticated, it conveys the problem to the driver. Most importantly, the brakes perform as normal until the failure is serviced.
- ▶ **Hill Start Assist**. When the vehicle is angled on hills or inclines, this system keeps your Ram 1500 stationary for two seconds after the brakes have been released or until the accelerator is depressed.

#### **ParkSense<sup>®</sup> Front and Rear Park Assist<sup>5</sup>**

This available feature uses integrated sensors with ultrasonic waves to detect objects as far as 47 inches away from the bumpers. Read-outs located in the gauge cluster display team up with audible chimes to notify the driver of proximity to front and/or rear objects.

**NAV ASSIST | REAL-TIME VEHICLE INFO | VEHICLE SYSTEMS MONITORING | CUSTOMIZABLE**

## **DRIVER INFORMATION DISPLAY**

Your Ram 1500 truck is a rolling powerhouse of knowledge, instant information and state-of-the-art communications technologies. And it's all in your command, starting with the available and customizable full-color seven-inch Driver Information Display with some 34 menu options along with detailed graphics that convey real-time vehicle information.

Select models inform you with a six-ring instrumentation cluster, and you can always move up to the largest available 8.4-inch touchscreen media center.<sup>3</sup> Add totally leading-edge telematics through Uconnect, and you've got it all: tunes, info, web content,<sup>7</sup> vehicle control. That's Ram 1500.





# IT'S ALL ABOUT HANDLING, COMFORT AND EFFICIENCY.

## THE ACTIVE-LEVEL™ FOUR-CORNER AIR SUSPENSION SYSTEM



**IT'S ALL ON THE LEVEL. ACTIVE-LEVEL, THAT IS.** The available class-exclusive<sup>3</sup> Active-Level Four-Corner Air Suspension System is driver-selectable for the Off-Road and Entry/Exit Modes, and kicks in automatically for Aero Mode when cruising. Count on improved fuel efficiency, responsive road manners and fantastic ride and handling.

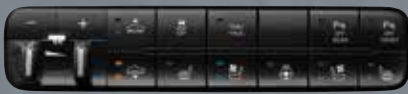

► Dashboard-mounted for easy access, the integrated switchbank enables instant control over the five modes.

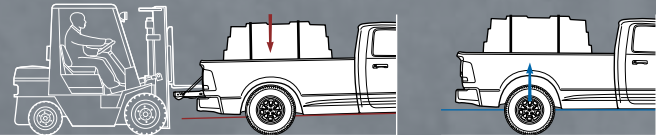

► Active-Level technology at work: it automatically counteracts when weight is added to the bed, maintaining a constant and level profile.







# AGGRESSIVE

**+2.0 in.**

**OFF-ROAD 2 MODE** Provides impressive ground clearance for the path or trail and generous angles for approach, departure and breakover.

# OFF-ROAD

**+1.2 in. front; +0.9 in. rear**

**OFF-ROAD MODE** Provides outstanding ride balance, with an extra degree of clearance when off-road scenarios are less severe than those warranting Off-Road 2 Mode.

# FREEWAY

**-0.6 in.**

**AERO MODE** Automatically lowers the vehicle at highway speeds, reducing aerodynamic drag and "body roll," and improving fuel efficiency.

# NORMAL RIDE HEIGHT

For everyday driving. Provides the most comfortable balance of ride and handling.

# ENTRY/EXIT

**-2.1 in. front; -1.7 in. rear**

**ENTRY/EXIT MODE** Lowers the vehicle when stopped, for easier entry/exit, loading/unloading and convenient trailer hooking/unhooking.



Properly secure all cargo.



# EFFICIENT & CAPABLE



**29 MPG HWY\*: THE BEST FUEL ECONOMY OF ANY FULL-SIZE PICKUP<sup>2</sup>**

► **THE 3.0L ECODIESEL V6.** It made history when we pioneered it, and today, mated to the TorqueFlite<sup>®</sup> 8-speed automatic, this powertrain delivers superb torque and an outstanding driving range—topped off with the best fuel economy of any full-size pickup<sup>2</sup>



\*2016 EPA estimated 21 mpg city/29 mpg hwy based on Ram 1500 EcoDiesel V6 HFE 4x2. Actual results may vary.





# 29 MPG HWY<sup>2\*</sup>



UP TO 754-MILE DRIVING RANGE<sup>9</sup>



**420 LB-FT OF TORQUE | BEST-IN-CLASS<sup>8</sup> COMBINATION OF V6 FUEL ECONOMY & TORQUE**



\*2016 EPA estimated 21 mpg city/29 mpg hwy based on Ram 1500 EcoDiesel V6 HFE 4x2. Actual results may vary. Vehicle shown does not represent HFE model.



# POWERTRAIN: WHERE RAM FLEXES SERIOUS MUSCLE.



## A LEADER: 3.0L ECODIESEL V6 5 YEAR/100,000 MILE<sup>10</sup> POWERTRAIN LIMITED WARRANTY

**TOUGH AS NAILS—WITH A WARRANTY THAT PROVES IT.** This available leader stands tall by delivering everything a diesel powerhouse should: impressive torque for pulling and hauling; clean-diesel technology that's B20-compliant; and durability that measures up over years and miles—reflected in one of the best warranties in the industry.

**29 MPG HWY\* | UP TO 754-MILE RANGE<sup>9</sup> | 240 HORSEPOWER | 420 LB-FT OF TORQUE**

### 3.0L ECODIESEL V6 CAPABILITY (WHEN PROPERLY EQUIPPED)



REGULAR CAB 8' BOX  
9,210-LB MAX TOW CAPACITY  
1,510-LB PAYLOAD CAPACITY



QUAD CAB® 6'4" BOX  
8,960-LB MAX TOW CAPACITY  
1,590-LB PAYLOAD CAPACITY



CREW CAB 5'7" BOX  
8,870-LB MAX TOW CAPACITY  
1,530-LB PAYLOAD CAPACITY



CREW CAB 6'4" BOX  
8,340-LB MAX TOW CAPACITY  
1,250-LB PAYLOAD CAPACITY



## A LEGEND: 5.7L HEMI® V8 5 YEAR/60,000 MILE<sup>11</sup> POWERTRAIN LIMITED WARRANTY

**PERFORMANCE AT THE TOP OF THE GAME.** Few available engines carry its clout, and even fewer offer such fuel-sipping technology. Factor in advantages like Variable Valve Timing (VVT), the ingenious Multi-Displacement System (MDS) (to transform this mighty V8 into a robust 4-cylinder) and the built-in efficiencies of the hemispherical head design.

**22 MPG HWY<sup>†</sup> | 395 HORSEPOWER | 410 LB-FT OF TORQUE**

### 5.7L HEMI V8 CAPABILITY (WHEN PROPERLY EQUIPPED)



REGULAR CAB 6'4" BOX  
9,160-LB MAX TOW CAPACITY  
1,590-LB PAYLOAD CAPACITY



REGULAR CAB 8' BOX  
10,620-LB MAX TOW CAPACITY  
1,690-LB PAYLOAD CAPACITY



QUAD CAB 6'4" BOX  
10,340-LB MAX TOW CAPACITY  
1,760-LB PAYLOAD CAPACITY



CREW CAB 5'7" BOX  
10,220-LB MAX TOW CAPACITY  
1,680-LB PAYLOAD CAPACITY



CREW CAB 6'4" BOX  
10,200-LB MAX TOW CAPACITY  
1,640-LB PAYLOAD CAPACITY



## A STAR: 3.6L PENTASTAR® V6 5 YEAR/60,000 MILE<sup>11</sup> POWERTRAIN LIMITED WARRANTY

**A SMALL PACKAGE WITH STELLAR PROFICIENCY.** The award-winning gas-powered 3.6L Pentastar V6 offers ultra-capable performance with remarkable fuel efficiency, and employs a Thermal Management System to help keep the internal components operating at the ideal temperatures.

**25 MPG HWY<sup>‡</sup> | 305 HORSEPOWER | 269 LB-FT OF TORQUE**

### 3.6L PENTASTAR V6 CAPABILITY (WHEN PROPERLY EQUIPPED)



REGULAR CAB 6'4" BOX  
7,260-LB MAX TOW CAPACITY  
1,560-LB PAYLOAD CAPACITY



REGULAR CAB 8' BOX  
7,270-LB MAX TOW CAPACITY  
1,880-LB PAYLOAD CAPACITY



QUAD CAB 6'4" BOX  
7,600-LB MAX TOW CAPACITY  
1,880-LB PAYLOAD CAPACITY



CREW CAB 5'7" BOX  
7,510-LB MAX TOW CAPACITY  
1,820-LB PAYLOAD CAPACITY

## AN ENABLER: TORQUEFLITE® 8-SPEED

**STANDARD FOR EVERY RAM 1500 ENGINE.** It was created with a dual-purpose mission: provide impeccable performance from highway cruising to heavy hauling—while contributing to those impressive figures that, when paired with the available 3.0L EcoDiesel V6, give Ram 1500 the best fuel economy of any full-size pickup.<sup>2</sup> It accomplishes both—and even provides steering wheel-mounted buttons for manual gear selection.

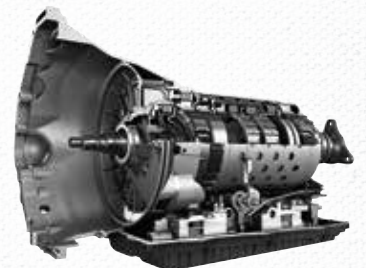

\*2016 EPA estimated 21 mpg city/29 mpg hwy based on Ram 1500 EcoDiesel V6 HFE 4x2. Actual results may vary. <sup>†</sup>EPA estimated 15 mpg city/22 mpg hwy based on Ram 1500 V8 4x2. Actual results may vary. <sup>‡</sup>EPA estimated 17 mpg city/25 mpg hwy based on Ram 1500 3.6L V6 4x2. Actual results may vary.

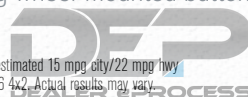





Properly secure all cargo.



# 10,620-LB MAX TOW,\* FROM VACATION TO VOCATION.



**ELIMINATE LIFE'S UPS AND DOWNS.** Boost capability and convenience. The class-exclusive<sup>3</sup> available Active-Level™ Four-Corner Air Suspension System delivers five modes of operation. Crucially, it makes trailering a breeze, simplifying ball/hitch alignment. The bigger picture? The system counteracts weight from trailering/hauling, maintains an even and level profile when loaded, and keeps constant the rake from the front end to the rear of the trailer.

**SUSPENSION MANAGEMENT** is at your fingertips. The dash-mounted integrated switchbank lets you raise or lower the vehicle through the available Active-Level Four-Corner Air Suspension System, and also lets you control the available trailer brake gain while towing.

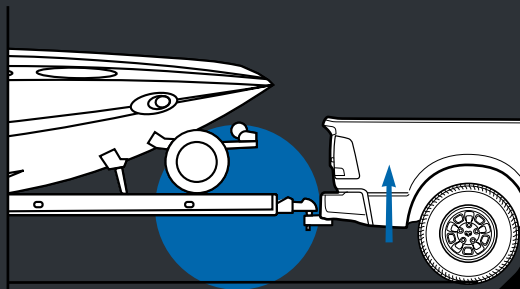
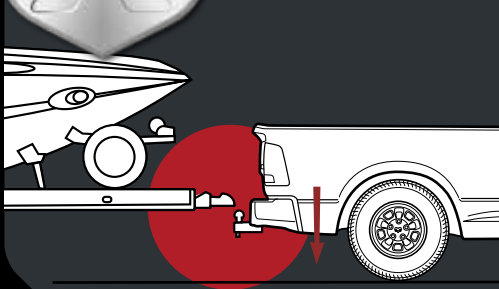

**STAY AHEAD OF THE GAME. LOOK BACK.** Make towing a cinch. Available ParkView® Rear Back-Up Camera<sup>5</sup> with Active Grid Lines is a natural for aligning the trailer ball with the hitch.

**DOZENS OF MENU OPTIONS** include data about the available trailer brake controller. This reading signals that the brake is at 65% of total operation with a 10% gain. You'll control the gain that's right for the terrain with the center stack-mounted trailer brake controller.

**COVER EVERY ANGLE.** Monitoring your trailer is critical. Extra-wide available trailer-towing mirrors on each side are the answer. Measuring a substantial 7 x 11 inches, they offer a maximum view, with a wide-angle mirror for peripheral traffic.



\*When properly equipped. Properly secure all cargo.





# CARGO MANAGEMENT FOR WORK AND PLAY.



## THE BENCHMARK FOR CARGO VERSATILITY.

► **THE AVAILABLE RAMBOX® CARGO MANAGEMENT SYSTEM.** Ram 1500 pioneered it, and it's still the best-in-class<sup>3</sup> Cargo Management System. The bins and rails are so versatile, they handle a wide variety of authentic accessories from Mopar®.



**AVAILABLE PREMIUM KEYLESS ENTER 'N GO!™** Count on multiple conveniences: keyless (bladeless) Remote Start; control of the AllSecure® Locking System (including both RamBox System bins, if so equipped); control of the panic button; operation of the Entry/Exit Mode of the available Active-Level™ Four-Corner Air Suspension System.



Properly secure all cargo.







## STOW YOUR GEAR

**STOW IT, STORE IT, LOCK IT** Lockable, drainable and illuminated, the two side boxes carry it all: tools, sports equipment—even iced beverages. They also accommodate numerous Mopar® accessories for work and play.



## LIGHT THE BED

**TWO POINTS OF LIGHT** Augmenting the CHMSL-mounted cargo bed light, these side bed-mounted LED lights are perfect for night loading, and operate without tonneau cover adjustment (if so equipped).

## EXTEND & DIVIDE

**COLLAPSIBLE AND RIGHT AT HAND: THE BED EXTENDER/DIVIDER**

Create compartments for specific cargo, or extend space to the open tailgate. With a smart, thin profile, it's easily stored at the head of the bed when not in use.

## SECURE THE LOAD

**CARGO RAIL SYSTEM WITH ADJUSTABLE TIE-DOWN CLEATS** Make sure it's all safe and secure. Cargo rails also accommodate numerous accessories from Mopar, while the four movable cleats ensure that your cargo stays where it's supposed to.





24/7 FOR EVERY  
4x8 OUT THERE.



RAMBOX<sup>®</sup> CARGO MANAGEMENT  
SYSTEM: A COMPREHENSIVE SOLUTION  
THAT GIVES YOU ABUNDANT STORAGE  
(YET LEAVES SPACE TO HAUL A LOAD  
OF BUILDING MATERIAL).

Properly secure all cargo.

**DEP**  
DEALER ePROCESS





**YES, TAKE IT  
ALL WITH YOU.**

► **PLACES TO STORE, FROM DASH TO FLOOR.** Hauling, carrying, moving. That's life with Ram. Which is why, depending on model, you'll find it all: dual glove boxes, removable and drainable in-floor bins, multi-use center consoles, under- and behind-the-seat storage—and the fold-flat load floors of Quad Cab® and Crew Cab.

Properly secure all cargo.

**DEALER ePROCESS**







# TECHNOLOGY: ELEGANTLY AND POWERFULLY SIMPLE.



Uconnect®

EVERYTHING YOU NEED TO STAY CONNECTED.



**DISCOVER NEW PLACES**

AT HOME OR ON THE ROAD: FIND THE BEST RESTAURANTS, SHOPPING AND ENTERTAINMENT VENUES WITH A QUICK SEARCH.\*

\*Certain features not available while vehicle is in motion.



**START YOUR RAM FROM AFAR**

WARM UP THE ENGINE AND CABIN, UNLOCK YOUR DOORS OR FLASH YOUR HEADLAMPS—JUST BY USING YOUR PHONE!†



**CUSTOMIZE WITH DRAG AND DROP**

SELECT FROM A MENU OF APPS AND DRAG YOUR CHOICES INTO PLACE ALONG THE BOTTOM ROW FOR EASY CUSTOMIZATION.

**CALL**

**9-1-1**

**ASSIST IN EMERGENCIES**

IT'S INVALUABLE AND POTENTIALLY LIFE-SAVING. ACCESS 9-1-1 CALL<sup>19</sup> OR ROADSIDE ASSISTANCE<sup>18</sup> WITH THE TOUCH OF A BUTTON.



**HOST A HOTSPOT**

UPLOAD AND DOWNLOAD, POST AND SEARCH. UCONNECT<sup>™</sup> WITH AVAILABLE WI-FI HOTSPOT<sup>™</sup> LETS YOU CONNECT YOUR DEVICES DIRECTLY TO THE WEB.

\*Additional charges apply.



**NAVIGATE YOUR ADVENTURES**

ENTER DESTINATIONS WITH JUST YOUR VOICE AND GET TURN-BY-TURN AUDIO DIRECTIONS. IT'S THE SMARTEST ROUTE TO ANY DESTINATION—ON- OR OFF-ROAD.



**LISTEN TO MUSIC, TALK SHOWS AND SPORTS**

KEEP THINGS MOVING WITH THE BEST VARIETY OF ENTERTAINMENT ON THE ROAD. YOU CAN SCREAM ABOUT SPORTS, TALK BACK TO TALK RADIO, CHUCKLE AT YOUR FAVORITE COMIC AND SOUND OFF ABOUT THE NEWS.



**WEATHER ON DEMAND**

WHETHER YOU'RE TRAVELING ACROSS TOWN OR ACROSS THE COUNTRY, PULLING UP THE MOST RECENT WEATHER REPORT GIVES YOU INSTANT INFO ABOUT WHAT NATURE HAS IN STORE.



**SPEAK UP AND BE HEARD**

SIRI<sup>®</sup> EYES FREE<sup>13</sup> RESPONDS TO YOUR VOICE!<sup>14</sup> MAKING FOR A CONVENIENT WAY TO SAFELY AND EASILY CONTROL YOUR IPHONE.<sup>2</sup>

SiriusXM<sup>®</sup> TRAVEL LINK<sup>®</sup>

**SEE INTO THE FUTURE**

TAKE ADVANTAGE OF WEATHER AND TRAFFIC REPORTS WITH A FIVE-YEAR TRIAL SUBSCRIPTION<sup>20</sup> TO SIRIUSXM<sup>®</sup> TRAVEL LINK<sup>®</sup> AND SIRIUSXM TRAFFIC!<sup>21</sup>

<sup>20</sup>Available on select Uconnect systems. See dealer for details.



**KNOW THE ROAD**

KEEP INFORMED ABOUT WHAT LIES AHEAD, FROM TRAFFIC TO ROAD CONDITIONS AND DELAYS—AND EVEN POSSIBLE DANGERS.

Available features shown. See your dealer for details.













# A TRUE REBEL<sup>®</sup> STANDS OUT.



Properly secure all cargo.





**PERFORMANCE-INSPIRED INTERIOR DESIGN.** Ram 1500 Rebel® distinguishes itself by taking outside cues for inside touches. Our designers liked the tread pattern of the huge Toyo® Open Country tires so much, they incorporated it into the seat patterns. Note that Ram Rebel includes a 10-way power driver's bucket seat, and a heated steering wheel that features mounted audio controls for the standard Uconnect® 8.4 with Bluetooth.®

**ITS VERY NAME DEFIES CONVENTION.** This customized pickup shows where Ram 1500 is heading. Rebel is a spacious Crew Cab with an interior featuring a unique "tire-tread" embossed treatment on the two-tone seats. Outside, look for an aggressive Ram centric grille and tailgate, while underneath, the standard Active-Level™ Four-Corner Air Suspension System rides with a one-inch height increase. Power depends on configuration: 3.6L Pentastar® V6 for 4x4 models, and 5.7L HEMI® V8 standard on 4x2 and available for 4x4 Rebel. The final touches add tow hooks and monster 33-inch Toyo Open Country tires mounted on 17-inch aluminum wheels with Matte Black pockets.



**AT-HAND CONVENIENCES.** The center stack is custom-made for tomorrow's technodude, with generous storage, sculpted cup holders and a dedicated spot for a smartphone. Dashboard and instrument-panel switches are intuitive, and here, Red accents are used to highlight eye-catching details and touchpoints throughout the cabin, including seats with subtle stitching.

**A REBEL. AND YET SO REFINED, IT REDEFINES.** It comes off the line with built-in attitude—and an interior that combines a sense of power with an advanced degree in aesthetics. Check out the standard Rebel® premium cluster with 7-inch Driver Information Display, Uconnect® 8.4-inch touchscreen radio, brushed aluminum touches and full-size floor console.



Properly secure all cargo.

**DEP**  
DEALER ePROCESS





# UNLIMITED STYLE. LIMITED

► **THE PEAK OF REFINEMENT.** Powered by the 5.7L HEMI® V8 or optional 3.0L EcoDiesel V6, the 2017 Ram 1500 Limited features a chrome grille with Ram logo, chrome bodyside moldings, chrome wheel-to-wheel side steps (with the HEMI V8) and 20-inch aluminum wheels. Shown above with optional chrome bumpers and body-color wheel flares; below, the signature Ram tailgate with standard chrome and available Black Ram logo.







▶ **NO LUXURY HAS BEEN SPARED.** Driving a Ram 1500 Limited removes all doubt as to who's in charge. This Black interior with premium leather houses all that's good: heated/ventilated front seats and heated rear seats, premium wood/leather-wrapped heated steering wheel, Platinum Chrome accents and a Uconnect® 8.4-inch touchscreen radio that includes Navigation.







# LARAMIE LONGHORN<sup>®</sup>

► **THE ARCHITECTURE OF SOPHISTICATION.**  
Ram 1500 Laramie Longhorn shown with Monotone paint, an option which also includes chrome bumpers and 20-inch aluminum wheels with painted Silver inserts. Shown with optional chrome wheel-to-wheel side steps.

Properly secure all cargo.















► **CRAFTSMANSHIP AT ITS VERY BEST.** Ram 1500 Laramie Longhorn® interior appointments include premium leather heated/ventilated front seats, genuine European burl wood accents, full-color multiview displays and stunning touchpoints throughout. Shown here in Cattle Tan/Black.





# LIVE THE GOOD LIFE. LARAMIE®

▶ **GOOD LOOKS ARE STANDARD IN LARAMIE.** With its 3.6L Pentastar® V6 and available 5.7L HEMI® V8 or 3.0L EcoDiesel V6, look for a chrome grille with chrome wave inserts, body-color wheel flares, premium projector headlamps and 20-inch chrome-clad aluminum wheels.

Properly secure all cargo.







# SIX-PACK

▶ **THE VIEW IS ALWAYS STUNNING.** The refined Ram 1500 Laramie® interior: standard seating for six, with heated and ventilated leather-trimmed driver and front-passenger seats, heated steering wheel, power pedals with memory, premium 10-speaker audio system and Dual-Zone Automatic Temperature Control.





# LISTEN TO THE NIGHT.



► **THERE'S A BRIGHT NEW STAR ON THE HORIZON.**

Powered by the 3.6L Pentastar® V6, the new 2017 Ram 1500 Night shines with its Black projector headlamps, Black grille and badges, heated deluxe cloth/vinyl high-back front bucket seats with 10-way power driver seat, heated and leather-wrapped steering wheel, Uconnect® 8.4-inch touchscreen radio and authoritative semi-gloss 20-inch aluminum wheels in Black. Further factory options include heated/ventilated leather-trimmed power high-back front bucket seats, the 5.7L HEMI® V8, Sport performance hood, dual exhaust, RamBox® Cargo Management System and Black tubular side steps, while Mopar® offers the Cat-Back Exhaust, Cold Air Intake and Ram Air Kit. Head to [RAMNIGHTCATBACK.COM](http://RAMNIGHTCATBACK.COM) to hear more.



# STANDOUT MVP. SPORT



► **IT'S A WHOLE NEW BALL GAME.** The 3.6L Pentastar® V6 (or optional 5.7L HEMI® V8), TorqueFlite® 8-speed automatic and available Sport performance hood level the playing field. To that, add bifunctional projector headlamps, body-color full front fascia, grille and rear bumper, the Luxury Group and Heated Seats and Wheel Group, available Class IV hitch receiver and 20-inch polished aluminum wheels.







# THE WORKHORSE. BIG HORN®

► **PURE CAPABILITY, NATURALLY.** Meld functionality with comfort, with the 3.6L Pentastar® V6, Uconnect® 8.4 with Bluetooth®, fold-flat load floor (on Big Horn Quad Cab® and Crew Cab models), power 10-way driver's seat and ParkView® Rear Back-Up Camera<sup>5</sup>—all riding on 20-inch chrome-clad aluminum wheels.



Properly secure all cargo.





THE FAST LANE.  
EXPRESS

► **EXPRESS YOURSELF.** Ram 1500 Express® delivers powerful choices: a full body-color front fascia, rear bumper and grille; fog lamps; 17-inch aluminum wheels; 3.6L Pentastar® V6 or optional 5.7L HEMI® V8; standard TorqueFlite® 8-speed automatic. Shown here with the optional Black Express Group.







# CUSTOM-MINDED.

Ram 1500 Rebel® in Flame Red with Brilliant Black lower with available Mopar® accessories, including Sport Performance Hood Decal Kit, Black Tubular Side Steps, Off-Road Wheel Flares and Tonneau Cover.

## CUSTOMIZE YOUR RAM 1500.

Authentic Ram parts and accessories by Mopar go far beyond simply giving you a means to personalize your Ram 1500—they give you nearly unlimited potential to ramp up comfort, convenience and performance.

Mopar accessories cover it all. You can enhance towing capability, ease getting in or out, select from a variety of protective devices, and add flair to both the interior and exterior. Conceived and engineered by the same experts who designed your Ram truck, you're assured of perfect fit, function and finish.

Further advantages of Mopar are wide-ranging. Mopar Express Lane Service minimizes waiting and downtime. The Mopar Vehicle Protection® Plan is the only extended protection backed by the manufacturer. The online record-keeping of your service records is a click away, through our Mopar Owner Connect web site—and it's also where you'll get additional vehicle information and exclusive money-saving offers as a preferred Ram owner.

Mopar support. It's all about keeping you happy and keeping your Ram 1500 in top-notch looks and condition. Check it out at [MOPAR.COM](http://MOPAR.COM)



Sport Performance Hood Decal Kit



Black Tubular Side Steps



Off-Road Wheel Flares



20-inch Black Aluminum Wheels





## RAM 1500 TRIM LEVELS

### TRADESMAN®

Ready-to-work attitude with every economy you need (shown with optional RamBox® Cargo Management System)



#### POWERTRAIN

- 3.6L Pentastar® V6 Flex Fuel 24V Variable Valve Timing (VVT) engine/8-speed automatic (22B)
- 5.7L HEMI® V8 Multi-Displacement System (MDS) VVT engine/8-speed automatic (26B/27B)
- 3.0L EcoDiesel V6 engine/8-speed automatic (28B)

#### STANDARD FEATURES:



#### INTERIOR AMENITIES

- Heavy-duty vinyl 40/20/40 split bench seat
- Front armrest with three cup holders
- Power windows and locks (Quad Cab® and Crew Cab)
- 2nd-row in-floor storage bins (Crew Cab)
- Rear folding seat (Quad Cab and Crew Cab)
- Black vinyl floor covering
- Rear fixed window
- Tinted-glass windows
- Rearview day/night mirror
- Manual air conditioning
- Instrument cluster with 3.5-inch Driver Information Display
- Black instrument panel bezel
- 3.0 AM/FM radio
- Six-speaker audio system
- Media Hub with audio jack and remote USB port
- 12-volt auxiliary power outlet

#### EXTERIOR FEATURES

- Black power heated mirrors (Quad Cab and Crew Cab)
- Incandescent taillamps
- Quad-halogen headlamps
- Black rear bumper
- Black front bumper
- Black upper fascia
- Black grille
- Black door handles
- 17-inch steel wheels
- P265/70R17 BSW All-Season tires
- Locking tailgate

#### CAPABILITY & FUNCTIONALITY

- Electronic shift-on-the-fly part-time transfer case (4x4 only)
- Trailer Tow Wiring with 4- and 7-pin connector
- Class IV hitch receiver
- 26-gallon fuel tank (5' 7" and 6' 4" beds)
- 32-gallon fuel tank (8' bed; non-EcoDiesel models)
- Speed control
- Electronic power rack and pinion steering
- Front heavy-duty shock absorbers
- Rear heavy-duty shock absorbers
- Front stabilizer bar
- Active Grille Shutters

#### SAFETY & SECURITY

- Six air bags<sup>18</sup> including driver and front-passenger, side-curtain and front-seat side-mounted
- Electronic Stability Control (ESC)<sup>4</sup>
- Antilock 4-wheel disc brakes
- Sentry Key® Theft Deterrent System
- Tire Pressure Monitoring System with display

### ECDIESEL HFE TRADESMAN

Its very name spells out High Fuel Efficiency (Quad Cab 4x2 only)



#### POWERTRAIN

- 3.0L EcoDiesel V6 engine/8-speed automatic (28E)

#### INCLUDES SELECT TRADESMAN FEATURES, PLUS:



#### INTERIOR AMENITIES

- Vinyl 40/20/40 front bench seat
- Vinyl folding rear bench seat with under-seat compartment

#### EXTERIOR FEATURES

- Tri-folding tonneau cover
- HFE badge
- Wheel-to-wheel side steps
- 20-inch aluminum wheels

#### CAPABILITY & FUNCTIONALITY

- 800-amp battery
- 230-amp alternator
- 3.55 axle ratio
- Class IV hitch delete
- Active Grille Shutters



## RAM 1500 TRIM LEVELS

### EXPRESS

Pure capability with functional interiors



#### POWERTRAIN

- 3.6L Pentastar® V6 Flex Fuel 24V Variable Valve Timing (VVT) engine/8-speed automatic (22J)
- 5.7L HEMI® V8 Multi-Displacement System (MDS) VVT engine/8-speed automatic (26J/27J)

#### INCLUDES SELECT TRADESMAN® FEATURES, PLUS:



#### INTERIOR AMENITIES

- Carpet floor covering

#### EXTERIOR FEATURES

- Fog lamps
- Body-color full front fascia
- Body-color rear bumper
- Body-color grille

- Front and rear floor mats

- 17-inch aluminum wheels
- Class IV hitch delete
- Spray-in bedliner

### BIG HORN®

Premium amenities and complete practicality (shown with optional RamBox® Cargo Management System)



#### POWERTRAIN

- 3.6L Pentastar V6 Flex Fuel 24V VVT engine/8-speed automatic (22S)
- 5.7L HEMI V8 MDS VVT engine/8-speed automatic (26S/27S)
- 3.0L EcoDiesel V6 engine/8-speed automatic (28S)

#### INCLUDES SELECT EXPRESS FEATURES, PLUS:



#### INTERIOR AMENITIES

- Premium cloth 40/20/40 bench seat
- Rear 60/40 split-folding seat
- Overhead console with Universal Garage Door Opener
- Sun visors with illuminating vanity mirrors
- Rearview auto-dimming mirror with microphone
- Black 6 x 9-inch power heated/folding mirrors with supplemental lighting
- Premium instrument cluster with 7-inch Driver Information Display
- Glove box lamp
- Ashtray lamp
- Rear dome lamp with on/off switch
- Leather-wrapped steering wheel
- Power 10-way driver's seat with power lumbar adjuster
- Steering wheel-mounted audio controls
- Uconnect® 8.4 touchscreen radio with Bluetooth® Voice Command<sup>14</sup>
- 115-volt auxiliary power outlet
- Dual-Zone Automatic Temperature Control
- SiriusXM® Satellite Radio<sup>5</sup> with 1-year trial subscription

#### EXTERIOR FEATURES

- Fog lamps
- Chrome grille with chrome billet inserts
- Spray-in bedliner delete

#### CAPABILITY & FUNCTIONALITY

- Electronic shift-on-demand transfer case (4x4 only)

#### SAFETY & SECURITY

- Security alarm
- ParkView® Rear Back-Up Camera<sup>5</sup>

- 20-inch chrome-clad aluminum wheels
- LED Bed Lighting

- Class IV hitch receiver

- Remote Start System
- ParkSense® Front and Rear Park Assist<sup>5</sup>



#### AVAILABLE BLACK EXPRESS GROUP

- Includes Popular Equipment Group, Power and Remote Entry Group, Black badges, Black bezel headlamps, Black painted grille, Uconnect 5.0 radio and 20-inch Black painted aluminum wheels



Complete features, options and available packages for all trim levels are in the Buyer's Guide.



## RAM 1500 TRIM LEVELS

### SPORT

Head-turning good looks—with character to match (shown with optional RamBox® Cargo Management System)



#### POWERTRAIN

- 3.6L Pentastar® V6 Flex Fuel 24V Variable Valve Timing (VVT) engine/8-speed automatic (22L)
- 5.7L HEMI® V8 Multi-Displacement System (MDS) VVT engine/8-speed automatic (26L/27L)

#### INCLUDES SELECT BIG HORN® FEATURES, PLUS:



#### INTERIOR AMENITIES

- Heated front seats
- Heated steering wheel
- Deluxe cloth high-back bucket seats with full center console
- Luxury Group
- Heated Seats and Wheel Group
- Dual-Zone Automatic Temperature Control

#### EXTERIOR FEATURES

- Premium bifunctional halogen projector Black headlamps
- Sport LED taillamps
- Auto-dimming exterior mirrors
- Body-color power heated/folding mirrors with supplemental lighting

#### CAPABILITY & FUNCTIONALITY

- Class IV hitch delete

#### SAFETY & SECURITY

- Security alarm
- ParkView® Rear Back-Up Camera<sup>5</sup>

- Instrument panel with premium bezel
- LED interior lighting
- Power-adjustable pedals
- Rearview auto-dimming mirror with microphone
- SiriusXM® Satellite Radio<sup>6</sup> with 1-year trial subscription

- Body-color full front fascia
- Body-color rear bumper
- Body-color grille with chrome billet inserts
- P275/60R20 OWL All-Season tires
- 20-inch polished aluminum wheels

- Remote Start System

### NIGHT

Stunning style for any occasion (shown with optional RamBox Cargo Management System and Sport performance hood)



#### POWERTRAIN

- 3.6L Pentastar V6 Flex Fuel 24V VVT engine/8-speed automatic (22Q)
- 5.7L HEMI V8 MDS VVT engine/8-speed automatic (26Q/27Q)

#### INCLUDES SELECT SPORT FEATURES, PLUS:



#### INTERIOR AMENITIES

- Heated front seats
- Heated steering wheel
- Deluxe cloth high-back bucket seats with full center console
- Luxury Group
- Heated Seats and Wheel Group
- Dual-Zone Automatic Temperature Control

#### EXTERIOR FEATURES

- Black grille surround with Black mesh insert
- Black Ram tailgate badge

#### CAPABILITY & FUNCTIONALITY

- Class IV hitch delete

#### SAFETY & SECURITY

- Security alarm
- ParkView Rear Back-Up Camera<sup>5</sup>

- Instrument panel with premium bezel
- LED interior lighting
- Power-adjustable pedals
- Rearview auto-dimming mirror with microphone
- SiriusXM Satellite Radio<sup>6</sup> with 1-year trial subscription

- 20-inch Black semi-gloss aluminum wheels
- Black badges

- Remote Start System



#### AVAILABLE BLACK SPORT GROUP

- Includes 20-inch Black semi-gloss aluminum wheels, Black badges, Sport performance hood and nine amplified speakers with subwoofer



## RAM 1500 TRIM LEVELS

### REBEL®

Customized features, do-it-all-anywhere attitude, formidable capability (shown with optional RamBox® Cargo Management System)



#### POWERTRAIN

- 3.6L Pentastar® V6 Flex Fuel 24V Variable Valve Timing (VVT) engine/8-speed automatic (22W)
- 5.7L HEMI® V8 Multi-Displacement System (MDS) VVT engine/8-speed automatic (26W)

#### INCLUDES SELECT SPORT FEATURES, PLUS:



#### INTERIOR AMENITIES

- Unique Rebel premium cloth bucket seats with embossed tread pattern
- Rear 60/40 split-folding seat
- Unique Rebel interior accents
- Heated leather-wrapped steering wheel with Red accent stitching
- Unique Rebel door trim panels
- Dual-Zone Automatic Temperature Control
- Unique Rebel rubber floor mats
- Heated front seats
- Fold-flat load floor storage
- Power 10-way driver's seat with power lumbar adjuster
- Steering wheel-mounted audio controls
- 115-volt auxiliary power outlet
- Premium instrument cluster with 7-inch Driver Information Display
- Uconnect® 8.4 touchscreen radio with Bluetooth® Voice Command<sup>14</sup>
- SiriusXM® Satellite Radio<sup>6</sup> with 1-year trial subscription

#### EXTERIOR FEATURES

- Sport LED taillamps
- Bifunctional Sport halogen projector headlamps
- LED fog lamps
- Black powder-coated front and rear bumpers
- Black headlamp filler panel
- Unique Rebel Black grille with Ram logo
- Sport performance hood
- Black wheel flares
- Body-color door handles
- Ram tailgate badge
- Rebel tailgate badge
- 17-inch unique Rebel aluminum wheels with Matte Black pockets
- Toyo® LT285/70R17E BSW Open Country tires

#### CAPABILITY & FUNCTIONALITY

- Front Bilstein® monotube performance shocks
- Rear Bilstein monotube performance shocks
- Antispin rear differential

#### SAFETY & SECURITY

- Security alarm
- ParkView® Rear Back-Up Camera<sup>5</sup>
- Class IV hitch receiver
- Active-Level™ Four-Corner Air Suspension System
- Tow hooks
- Remote Start System
- ParkSense® Rear Park Assist<sup>5</sup>



#### AVAILABLE MONOTONE PAINT

- Shown with optional RamBox Cargo Management System

### LARAMIE®

Where luxury and leather trim come together



#### POWERTRAIN

- 3.6L Pentastar V6 Flex Fuel 24V VVT engine/8-speed automatic (22H)
- 5.7L HEMI V8 MDS VVT engine/8-speed automatic (26H/27H)
- 3.0L EcoDiesel V6 engine/8-speed automatic (28H)

#### INCLUDES SELECT SPORT FEATURES, PLUS:



#### INTERIOR AMENITIES

- Dual-Zone Automatic Temperature Control
- Heated driver and front-passenger seats
- Heated steering wheel
- Ventilated driver and front-passenger seats
- Leather-trimmed 40/20/40 bench seat
- Deluxe door trim panels
- Power-adjustable pedals with memory
- Instrument-panel woodgrain bezel
- Premium II 10-speaker audio system with subwoofer
- Power 10-way memory driver/6-way passenger seats
- SiriusXM Satellite Radio<sup>6</sup> with 1-year trial subscription

#### EXTERIOR FEATURES

- Premium LED taillamps
- Chrome 6 x 9-inch exterior mirrors with memory
- Bifunctional projector chrome headlamps
- Chrome grille with chrome wave inserts
- Body-color wheel flares
- Laramie tailgate badge
- 20-inch chrome-clad aluminum wheels

#### SAFETY & SECURITY

- Security alarm
- ParkView Rear Back-Up Camera<sup>5</sup>



#### AVAILABLE TWO-TONE PAINT

- Includes lower accent-color paint with accent-color wheel flares (shown with optional RamBox Cargo Management System)





## RAM 1500 TRIM LEVELS

### LARAMIE LONGHORN®

Sophistication meets power and comfort (shown with optional RamBox® Cargo Management System)



#### POWERTRAIN

- 5.7L HEMI® V8 Multi-Displacement System (MDS) Variable Valve Timing (VVT) engine/8-speed automatic (26K)
- 3.0L EcoDiesel V6 engine/8-speed automatic (28K)

**INCLUDES SELECT LARAMIE® FEATURES, PLUS:**



#### INTERIOR AMENITIES

- Premium filigree leather bucket seats
- Premium door trim panels
- Luxury front and rear floor mats
- Full-length premium floor console
- Laramie Longhorn instrument cluster with 7-inch Driver Information Display
- Mopar® Bright Door Entry Guards
- Laramie Longhorn interior accents
- Heated second-row seats
- Uconnect® 8.4 touchscreen radio with premium Navigation
- Premium wood/leather-wrapped steering wheel
- SiriusXM® Satellite Radio® with 1-year trial subscription

#### EXTERIOR FEATURES

- LED Bed Lighting
- Accent-color front and rear bumpers
- Lower accent two-tone paint
- Chrome grille with Ram logo
- Accent-color running boards and wheel flares
- Tow hooks

#### CAPABILITY & FUNCTIONALITY

- 32-gallon fuel tank

#### SAFETY & SECURITY

- ParkSense® Front and Rear Park Assist<sup>5</sup>
- Remote Start System
- Keyless Enter 'n Go™
- Rain-sensitive windshield wipers
- Auto High-Beam Headlamp Control



#### AVAILABLE MONOTONE PAINT

- Includes chrome front and rear bumpers, body-color wheel flares, cab-length chrome tubular side steps and 20-inch polished aluminum wheels with Silver inserts

### LIMITED

Black leather treatment joins stunning technology



#### POWERTRAIN

- 5.7L HEMI V8 MDS VVT engine/8-speed automatic (26V)
- 3.0L EcoDiesel V6 engine/8-speed automatic (28V)

**INCLUDES SELECT LARAMIE LONGHORN FEATURES, PLUS:**



#### INTERIOR AMENITIES

- Limited leather bucket seats
- Luxury front and rear floor mats
- Leather-wrapped grab handles
- Luxury door trim panels
- Rear-window defroster
- Limited cluster with 7-inch Driver Information Display
- Premium wood/leather-wrapped steering wheel
- SiriusXM Satellite Radio® with 1-year trial subscription

#### EXTERIOR FEATURES

- Body-color full front fascia
- Body-color rear bumper
- Chrome grille with Ram logo
- Chrome bodyside moldings
- Chrome belt moldings
- Unique Limited tailgate
- Chrome wheel-to-wheel side steps (if equipped with the HEMI V8)
- 20-inch polished aluminum wheels with Gray inserts

#### CAPABILITY & FUNCTIONALITY

- Active-Level™ Four-Corner Air Suspension System
- Tow hook delete

#### SAFETY & SECURITY

- ParkSense Front and Rear Park Assist<sup>5</sup>
- Remote Start System
- Keyless Enter 'n Go
- Rain-sensitive windshield wipers
- Auto High-Beam Headlamp Control



#### AVAILABLE CHROME BUMPER PACKAGE

- Includes chrome front and rear bumpers and body-color wheel flares



**RAM 1500 INTERIOR FABRICS**



**Vinyl  
Diesel Gray**  
Tradesman<sup>®</sup> Express and EcoDiesel HFE



**Sedoso/Alloy Cloth  
Diesel Gray**  
Tradesman and Express



**Sedoso/Carbide Cloth Diesel Gray**  
Big Horn<sup>®</sup>      **Sedoso/Carbide Cloth Canyon Brown**  
Big Horn



**Vinyl/Cloth with Embossed Tread Pattern  
Radar Red/Black**  
Rebel<sup>®</sup>



**Vinyl/Cloth with Embossed Tread Pattern  
Black**  
Rebel



**Bristol/Sport Mesh Cloth  
Black**  
Sport, Night



**Bristol Leather/Perforated Leather Trim  
Black**  
Sport, Night and Laramie<sup>®</sup>



**Bristol Leather/Perforated Leather Trim  
Light Frost Beige**  
Laramie



**Natura Plus Leather with Laser Etching/  
Perforated Leather with Dark Saddle Piping and  
Tan Accent Stitching  
Canyon Brown**  
Laramie Longhorn<sup>®</sup>



**Natura Plus Leather/Perforated Leather with  
Dark Saddle Piping and Tan Accent Stitching  
Canyon Brown**  
Laramie Longhorn



**Natura Plus Leather/Perforated Leather with  
Black Piping and Accent Stitching  
Cattle Tan**  
Laramie Longhorn



**Natura Plus Leather/Perforated Leather with  
Medium Graystone Piping and Accent Stitching  
Black**  
Limited



## RAM 1500 WHEELS



17-inch Argent Steel  
Standard on Tradesman® (WFP)



17-inch Painted Aluminum  
Standard on Express  
Optional on Tradesman (WFE)



17-inch Aluminum with  
Matte Black Painted Pockets  
Standard on Rebel® (WFK)



20-inch Painted Aluminum  
Standard on EcoDiesel HFE (WHE)



20-inch Chrome-Clad Aluminum  
Optional on Express (WR2)



20-inch Aluminum Painted  
Semi-Gloss Black  
Packaged with Black Express Group (WHN)



20-inch Chrome-Clad Aluminum  
Standard on Big Horn® (WHK)



20-inch Polished Aluminum  
Standard on Sport (WRF)



20-inch Aluminum Painted  
Semi-Gloss Black  
Standard on Night, Packaged with Black Sport Group (WRL)



20-inch Chrome-Clad Aluminum  
Standard on Laramie® (WRG)



20-inch Aluminum with Polished Face  
and Accent-Color Inserts  
Standard on Two-Tone Laramie Longhorn® (WRH)



20-inch Aluminum with Polished Face  
and Silver Inserts  
Standard on Laramie Longhorn with Monotone Paint (WRJ)











20-inch Polished Aluminum  
with Gray Inserts  
Standard on Limited (WRA)



22-inch Polished Forged Aluminum  
Standard on Regular Cab R/T  
Optional on Crew Cab Sport (WPZ)

## CONFIGURATIONS

	CAB			BOX			SEATING	
								
	Regular Cab	Quad Cab®	Crew Cab	5' 7" Box	6' 4" Box	8' Box	40/20/40 Bench Seat	Bucket Seats
Tradesman	•	•	•	Crew Cab	All Cabs	Reg Cab	•	N/A
EcoDiesel HFE	N/A	•	N/A	N/A	•	N/A	•	N/A
Express	•	•	•	Crew Cab	Reg or Quad Cab	N/A	•	N/A
Big Horn	•	•	•	Crew Cab	All Cabs	Reg Cab	•	Optional
Sport	•	•	•	Crew Cab	All Cabs	N/A	N/A	•
Night	•	•	•	Crew Cab	All Cabs	N/A	N/A	•
Rebel	N/A	N/A	•	•	N/A	N/A	N/A	•
Laramie	N/A	•	•	Crew Cab	Reg or Quad Cab	N/A	•	Optional
Laramie Longhorn	N/A	N/A	•	•	•	N/A	N/A	•
Limited	N/A	N/A	•	•	•	N/A	N/A	•

• = Available Configuration    N/A = Not Available





## RAM 1500 EXTERIOR COLORS



Bright White



Pearl White



Bright Silver Metallic



Granite Crystal Metallic



Maximum Steel Metallic



Brilliant Black Crystal Pearl



Blue Streak Pearl



True Blue Pearl



Luxury Brown Pearl



Flame Red



Delmonico Red Pearl



Black Forest Green Pearl

### PAINT COLORS AND TWO-TONE OPTIONS

	Bright White	Pearl White	Bright Silver Metallic	Granite Crystal Metallic	Maximum Steel Metallic	Brilliant Black Crystal Pearl	Blue Streak Pearl	True Blue Pearl	Luxury Brown Pearl	Flame Red	Delmonico Red Pearl	Black Forest Green Pearl
<b>Tradesman®</b>	•	N/A	•	•	•	•	•	•	•	•	•	•
<b>EcoDiesel HFE</b>	•	N/A	•	•	•	•	•	•	•	•	•	•
<b>Express</b>	•	N/A	•	•	•	•	•	•	N/A	•	•	N/A
<b>Big Horn®</b>	•	N/A	•	•	•	•	•	•	•	•	•	•
<b>Sport</b>	•	N/A	•	•	•	•	•	•	N/A	•	•	N/A
<b>Night</b>	•	N/A	•	•	N/A	•	N/A	N/A	N/A	•	N/A	N/A
<b>Rebel®</b>	M, ■	N/A	M, ■	M, ■	N/A	M	N/A	N/A	N/A	M, ■	N/A	N/A
<b>Laramie®</b>	M, ■	N/A	M	M, ■	M, ■	M, ■	M, ■	M, ■	M, ■	M, ■	M, ■	M, ■
<b>Laramie Longhorn®</b>	N/A	M, □	M	M	M	M, □	M	M	M, □	M	M, □	M, □
<b>Limited</b>	N/A	•	•	•	•	•	N/A	•	N/A	N/A	•	N/A



Laramie shown in Delmonico Red Pearl with Silver lower



Laramie Longhorn shown in Pearl White with White Gold lower

To see examples of all possible paint combinations, visit [ramtrucks.com](http://ramtrucks.com)

• = Available Color    N/A = Not Available    M = Monotone    ■ = Black Lower    ■ = Silver Lower    □ = White Gold Lower



# RAM 1500 BUYER'S GUIDE

	Sales Code	Tradesman® Reg/Quad/Crew	EcoDiesel HFE Quad Cab®	Express Reg/Quad/Crew	Big Horn® Reg/Quad/Crew	Sport Reg/Quad/Crew	Night Reg/Quad/Crew	Rebel® Crew Cab	Laramie® Quad/Crew	Laramie Longhorn® Crew Cab	Limited Crew Cab
		B	E	J	S	L	Q	W	H	K	V
<b>CPOS PACKAGE</b>											
<b>ENGINE/TRANSMISSION</b>											
3.6L Pentastar® V6 Flex Fuel 24V with VVT 8HP45 8-speed automatic	ERB/DFL	22B	-	22J	22 S	22L	22Q	22W	22H	-	-
5.7L HEMI® V8 with VVT and Fuel Saver Technology/8HP70 8-speed automatic (Regular Cab and Crew Cab)	EZH/DFK	26B	-	26J	26 S	26L	26Q	26W	26H	26K	26V
5.7L HEMI V8 with VVT and Fuel Saver Technology/8HP70 8-speed automatic (Quad Cab only)	EZH/DFD	27B	-	27J	27 S	27L	27Q	-	27H	-	-
3.0L EcoDiesel V6/8HP70 8-speed automatic	EXF/DFD	28B	28E	-	28 S	-	-	-	28H	28K	28V
<b>MECHANICAL FEATURES</b>											
ACTIVE GRILLE SHUTTERS (included with 8-speed automatic transmission)	MDX	P	S	P	P	P	P	-	P	P	P
ALTERNATOR - 160-amp	BAB	S	-	S	S	S	S	S	S	S	S
- 230-amp (included with EcoDiesel V6)	BAM	P	S	-	P	-	-	-	P	P	P
AXLE - 3.21 ratio (not available with EcoDiesel V6)	DMC	S	-	S	S	S	S	0/S	S	S	S
- 3.55 ratio (included with EcoDiesel V6; not available with HEMI V8 with 8-speed transmission)	DMD	0/P	S	0	0/P	-	-	-	0/P	0/P	0/P
- 3.92 ratio (included with R/T 4x2)	DMH	0	-	0	0	0/P	0	S	0	0	0
- Antispin rear differential (included with R/T 4x2)	DSA	0	-	0	0	0/P	0	S	0	0	0
BATTERY - 730-amp	BCN	S	-	S	S	S	S	S	S	S	S
- 800-amp (included with EcoDiesel V6)	BCF	P	S	-	P	-	-	-	P	P	P
ENGINE BLOCK HEATER (included with Cold Weather Group if equipped with EcoDiesel V6)	NHK	0/P	P	0	0/P	0	0	0	0/P	0/P	0/P
ENGINE COOLING - Heavy-duty (included with HEMI V8)	NMC	P	-	P	P	P	P	P	P	P	P
- Maximum-duty (packaged with EcoDiesel V6)	NMX	P	P	-	P	-	-	-	P	P	P
FUEL TANK - 26-gallon (included with EcoDiesel V6)	NFW	S	S	S	S	S	S	S	S	P	P
- 32-gallon (included with 8'-box models; not available with EcoDiesel V6 or on Regular Cab short-box models; optional on 6' 4"- and 5' 7"-box models)	NFX	0/P	-	0	0	0	0	0	0	S	S
SHOCK ABSORBERS - Front, heavy-duty	SFB	S	S	S	S	S	S	-	S	S	S
- Rear, heavy-duty	SGB	S	S	S	S	S	S	-	S	S	S
- Front, Bilstein® Performance	SFC	-	-	-	-	-	-	S	-	-	-
- Rear, Bilstein Performance	SGC	-	-	-	-	-	-	S	-	-	-
STABILIZER BAR - Front	SHA	S	S	S	S	S	S	S	S	S	S
- Rear (not available on Regular Cab 4x2 8'-box models; included with 3.6L V6 on Regular Cab 4x2 6' 4" box; included with Regular Cab R/T 4x2 6' 4" box)	SHF	S	S	S	S	S/P	S	S	S	S	S
STEERING - Electronic rack and pinion	SBA	S	S	S	S	S	S	S	S	S	S
SUSPENSION - Front, upper and lower A-arms, coil springs, twin-tube shocks	NA	S	S	S	S	S	S	-	S	S	0
- Rear, five-link, coil springs, twin-tube shocks	NA	S	S	S	S	S	S	-	S	S	0
- Active-Level™ Four-Corner Air Suspension System: includes front upper and lower A-arms, air springs, twin-tube shocks; rear five-link, air springs, twin-tube shocks; air compressor and dual closed-loop system storage tanks (Quad Cab and Crew Cab only; not available for Crew Cab 4x2 models with 6' 4" box)	SER	0	-	0	0	0	0	S	0	0	S
TRAILER HITCH - Class IV hitch receiver (included with Trailer-Tow Mirrors and Brake Group)	XFH/XF9	S	-	0/P	S	0/P	0/P	S	S	S	S
TRANSFER CASE - Electronic part-time (4x4 models only)	DH9	S	-	S	-	-	-	S	-	-	-
- Electronic on-demand (4x4 models only)	DH8	-	-	-	S	S	S	-	S	S	S
WINCH - Tire carrier	TBM	S	S	S	S	S	S	S	S	S	S
<b>EXTERIOR FEATURES</b>											
BED LIGHTING - LED, included with RamBox® System and Luxury Group	LPL	0/P	-	0/P	S	P	P	P	0/P	S	S
BED RAILS - Chrome, tubular, for 5' 7"- and 6' 4"-bed sides (not available with RamBox System, tonneau cover or with 22-inch wheels)	MEB	-	-	-	0	0	0	0	0	0	0
BEDLINER - Spray-in	XMF	0	-	S	0	0	0	0	0	S	S
BELT MOLDINGS - Chrome	MME	-	-	-	-	-	-	-	-	S	S
BODY MODEL - Regular Cab 6' 4" box	61	0	-	0	0	0	0	-	-	-	-
- Regular Cab 8' box	62	0	-	-	0	-	-	-	-	-	-
- Quad Cab 6' 4" box	41	0	S	0	0	0	0	-	0	-	-
- Crew Cab 5' 7" box	98	0	-	0	0	0	0	S	0	0	0
- Crew Cab 6' 4" box	91	0	-	-	0	0	0	-	0	0	0
BODYSIDE MOLDINGS - Chrome (optional with Monotone paint only on Laramie)	MJB	-	-	-	0	-	-	-	0	-	S
BUMPERS - Front and rear, Black	MB1/MBN	S	S	-	-	-	-	-	-	-	-
- Front and rear Black powder-coated	MCS/MB5	-	-	-	-	-	-	S	-	-	-
- Front and rear painted lower accent color	MBU/MBV	-	-	-	-	-	-	-	-	S	-
- Front and rear Chrome (included with Chrome Appearance Group; included with Monotone paint; included with Chrome Bumper Package)	MCT/MBF	P	-	-	S	-	-	-	S	P	P
- Rear body-color	MBQ	-	-	S	-	S	S	-	-	-	S
DOOR HANDLES - Black (included with low-volume paint colors)	MNA	S	S	S	P	-	-	-	-	-	-
- Body-color	MNK	-	-	-	-	S	S	S	-	-	-
- Chrome with body-color bezel	MNE	-	-	-	S	-	-	-	S	S	S
EXHAUST - Single rear (included with 3.6L V6)	NA	P	S	P	P	P	P	P	P	-	-
- Dual rear (included with HEMI V8 or EcoDiesel V6)	NER	-	-	P	P	P	P	P	P	S	S
FASCIA - Front upper, Black (included with low-volume paint)	MCL	S	S	-	P	-	-	-	-	-	-
- Front upper, body-color (included with Chrome Bumper Package)	MCM	-	-	-	S	-	-	-	S	S	P
- Front full, body-color	MBP	-	-	S	-	S	S	-	-	-	S
FOG LAMPS	LNJ/LNV	-	-	S	S	S	S	S	S	S	S
GRILLE - Black surround, Black hex-link (included with low-volume paint)	MFF	S	S	-	-	-	-	-	-	-	-
- Black painted honeycomb grille (included with Black Express Group)	MFS	-	-	P	-	-	S	-	-	-	-
- Black Ram logo grille	MFM	-	-	-	-	-	-	S	-	-	-
- Chrome surround, Black hex-link (included with Chrome Appearance Group)	MFD	P	-	-	-	-	-	-	-	-	-
- Body-color surround, Black hex-link (included with R/T model)	MFT	-	-	S	-	P	-	-	-	-	-
- Body-color surround, chrome billet-perf	MFN	-	-	-	-	S	-	-	-	-	-
- Chrome surround, chrome billet-perf	MFH	-	-	-	S	-	-	-	-	-	-
- Chrome surround, chrome wave-perf	MF1	-	-	-	-	-	-	-	S	-	-
- Chrome Ram logo grille	MFJ	-	-	-	-	-	-	-	-	S	S

S = Standard, 0 = Optional, P = Part of package, - = Not available.  
Note: some features and/or applications may be late availability.





**RAM 1500 BUYER'S GUIDE**

	Sales Code	Tradesman® Reg/Quad/Crew	EcoDiesel HFE Quad Cab®	Express Reg/Quad/Crew	Big Horn® Reg/Quad/Crew	Sport Reg/Quad/Crew	Night Reg/Quad/Crew	Rebel® Crew Cab	Laramie® Quad/Crew	Laramie Longhorn® Crew Cab	Limited Crew Cab
		B	E	J	S	L	Q	W	H	K	V
<b>CPOS PACKAGE</b>											
<b>EXTERIOR FEATURES (CONTINUED)</b>											
HEADLAMPS/TAILLAMPS – Automatic	LMG	S	S	S	S	S	S	S	S	S	S
– Quad-lens halogen with incandescent taillamps	LME/LA6	S	S	S	S	–	–	–	–	–	–
– Quad-lens halogen, blackout look, with incandescent taillamps (included with Black Express Group)	MFA/LA6	–	–	P	–	–	–	–	–	–	–
– Sport blackout look bifunctional halogen projector with LED turn/running lights and LED taillamps	LMM/LAE	–	–	–	–	S	S	S	–	–	–
– Premium bifunctional halogen projector with LED turn/running lights	LMC/LAD	–	–	–	–	–	–	–	S	S	S
– Auto High-Beam Headlamp Control (included in Convenience Group)	LMS	–	–	–	–	P	P	–	P	S	S
MIRRORS – Manual, Black, 6 x 9-inch (Regular Cab only)	GPU	S	–	S	–	–	–	–	–	–	–
– Power, heated, folding, Black, 6 x 9-inch (included with Power and Remote Entry Group on Regular Cab Tradesman and Express models)	GT6	P/S	S	P/S	–	–	–	S	–	–	–
– Manual, folding trailer tow, Black, 7 x 11-inch (included with Trailer-Tow Mirrors and Brake Group; Regular Cab only)	GPD	P	–	P	–	–	–	–	–	–	–
– Power, heated, auto-dimming, power-folding, Black, 6 x 9-inch; includes exterior courtesy lamps and supplemental turn signals (included with Luxury Group)	GUK	–	–	–	S	–	–	P	–	–	–
– Power, heated, power-folding, auto-dimming, body-color 6 x 9-inch; includes exterior courtesy lamps and supplemental turn signals	GT5	–	–	–	–	S	S	–	–	–	–
– Power trailer tow, manual folding, Black, 7 x 11-inch; includes exterior courtesy lamps and supplemental turn signals (included with Trailer-Tow Mirrors and Brake Group; not available on Regular Cab Tradesman or Express models)	GPG	P	–	P	P	P	P	P	–	–	–
– Power multifunction, heated, auto-dimming, power-folding, chrome, 6 x 9-inch; includes position memory, exterior courtesy lamps and supplemental turn signals	GU4	–	–	–	–	–	–	–	S	S	S
– Power trailer-tow multifunction, heated, auto-dimming, manual folding, chrome, 7 x 11-inch, with position memory, exterior courtesy lamps and supplemental turn signals (included with Trailer-Tow Mirrors and Brake Group)	GPC	–	–	–	–	–	–	–	P	P	P
RUNNING BOARDS – Accent-color	MRM	–	–	–	–	–	–	–	–	S	–
SIDE STEPS – Tubular, cab-length, Chrome (included with Monotone paint; included with diesel engine on Limited models)	MRT	–	–	–	–	–	–	–	–	O/P	P
– Tubular, cab-length, Black (optional with Black Express Group and Black Sport Group)	MRU	O	–	O	–	O	O	O	–	–	–
– Tubular, wheel-to-wheel, Chrome (included with V8 on Limited)	MRA	O	S	O	O	O	O	–	O	O	P
SKID PLATE – Front suspension, 4x4 only (included with Protection Group)	XEU	P	–	–	P	–	–	P	P	P	–
– Transfer case, 4x4 only (included with Protection Group)	XEF	P	–	–	P	–	–	P	P	P	–
STORAGE – RamBox® Cargo Management System: includes pickup box with integrated bins which are weatherproof, lockable and drainable, bed rails with four adjustable cleats, dual-purpose bed divider/extender and LED Bed Lighting (5' 7"- and 6' 4"-box models only; not available with 8' box)	XB9	O	–	O	O	O	O	O	O	O	O
TIRES – P265/70R17 BSW All-Season	TTM	S	–	S	–	–	–	–	–	–	–
– LT265/70R17E OWL On-/Off-road	TXN	O	–	–	–	–	–	–	–	–	–
– LT285/70R17E BSW All-Terrain	TWG	–	–	–	–	–	–	S	–	–	–
– P275/60R20 BSW All-Season (included with Black Express Group or Black Sport Group; included with optional 20-inch wheels)	TTN	–	S	P	S	P	S	–	S	S	S
– P275/60R20 OWL All-Season (included with WR2 and WHE 20-inch wheels)	TUB	–	O	P	O	S	–	–	O	O	O
– P285/45R22 BSW All-Season (Regular Cab R/T 4x2 model; included with optional 22-inch wheels)	TY4	–	–	–	–	P	–	–	–	–	–
– Spare, full-size	TBB/TBS	S	S	S	S	S	S	S	S	S	S
TONNEAU COVER – Soft, tri-fold (available with or without RamBox System)	CS7/CSU	O	S	O	O	O	O	O	O	O	O
TOW HOOKS – Included with Protection Group (requires chrome bumpers for Limited)	XEA/XHW	P	–	–	P	–	–	S	O/P	S	O
WHEELS – Spare: 17-inch steel; 17-inch aluminum; 20-inch steel	W1A/ W1B/W1D	S	S	S	S	S	S	S	S	S	S
– 17 x 7-inch styled steel, painted Argent	WFP	S	–	–	–	–	–	–	–	–	–
– 17 x 7-inch painted cast-aluminum (included with Chrome Appearance Group)	WFE	P	–	S	–	–	–	–	–	–	–
– 17 x 8-inch aluminum with Matte Black pockets	WFK	–	–	–	–	–	–	S	–	–	–
– 20 x 8-inch painted Silver, aluminum	WHE	–	S	–	–	–	–	–	–	–	–
– 20 x 8-inch semi-gloss Black painted, aluminum (included with Black Express Group)	WHN	–	–	P	–	–	–	–	–	–	–
– 20 x 8-inch chrome-clad aluminum	WHK	–	–	–	S	–	–	–	–	–	–
– 20 x 9-inch chrome-clad aluminum	WR2	–	–	O	–	–	–	–	–	–	–
– 20 x 9-inch aluminum, polished	WRF	–	–	–	–	S	–	–	–	–	–
– 20 x 9-inch semi-gloss Black painted, aluminum (included with Black Sport Group)	WRL	–	–	–	–	P	S	–	–	–	–
– 20 x 9-inch chrome-clad aluminum	WRG	–	–	–	–	–	–	–	S	–	–
– 20 x 9-inch polished aluminum, with accent-color inserts	WRH	–	–	–	–	–	–	–	–	S	–
– 20 x 9-inch polished aluminum, with Silver-clad inserts (included with Monotone paint)	WRJ	–	–	–	–	–	–	–	–	P	–
– 20 x 9-inch polished aluminum with Gray inserts	WRA	–	–	–	–	–	–	–	–	–	S
– 22 x 9-inch polished forged aluminum (included with Regular Cab R/T 4x2 model; optional on Crew Cab 4x2)	WPZ	–	–	–	–	P/O	–	–	–	–	–
<b>INTERIOR FEATURES</b>											
AIR CONDITIONING – Manual	HAA	S	S	S	S	S	S	–	–	–	–
– Dual-Zone Automatic Temperature Control (Quad Cab and Crew Cab only)	HAF	–	–	–	S	S	S	S	S	S	S
CLUSTER – Instrument, with 3.5-inch display screen for Driver Information Display (DID)	JAT	S	S	S	–	–	–	–	–	–	–
– Premium instrument, with 7-inch DID	JAG	–	–	–	S	S	S	–	S	–	–
– Premium Rebel instrument, with 7-inch DID	JAJ	–	–	–	–	–	–	S	–	–	–
– Premium Laramie Longhorn instrument, with 7-inch DID	JAX	–	–	–	–	–	–	–	–	S	–
– Premium Limited instrument, with 7-inch DID	JAV	–	–	–	–	–	–	–	–	–	S
CONSOLE – Full-size floor (included with front bucket seats)	CUP	–	–	–	P	P	P	S	P	–	–
– Premium full-size floor with leather-wrapped accents	CVT	–	–	–	–	–	–	–	–	S	S
– Overhead (included with Uconnect® 5.0 radio)	CUN	P	–	P	–	–	–	S	–	–	–
– Overhead, with Universal Garage Door Opener (included with Luxury Group)	CV2	–	–	–	S	S	S	P	S	S	S
FLOOR MATS – Front, carpeted (Regular Cab; included with Popular Equipment Group)	CLA	P	–	S	S	S	S	–	–	–	–
– Front, rubber (Regular Cab)	CLY	O	–	O	–	O	O	–	–	–	–

S = Standard, O = Optional, P = Part of package, – = Not available.  
Note: some features and/or applications may be late availability.





**RAM 1500 BUYER'S GUIDE**

	Sales Code	Tradesman® Reg/Quad/Crew	EcoDiesel HFE Quad Cab®	Express Reg/Quad/Crew	Big Horn® Reg/Quad/Crew	Sport Reg/Quad/Crew	Night Reg/Quad/Crew	Rebel® Crew Cab	Laramie® Quad/Crew	Laramie Longhorn® Crew Cab	Limited Crew Cab
		B	E	J	S	L	Q	W	H	K	V
<b>CPOS PACKAGE</b>											
<b>INTERIOR FEATURES (CONTINUED)</b>											
- Front and rear, carpeted (Quad Cab and Crew Cab; included with Popular Equipment Group)	CLE	P	-	S	S	S	S	-	S	-	-
- Front and rear, rubber (Quad Cab and Crew Cab)	CLF/CL3	0	-	0	0	0	0	S	0	-	-
- Front and rear, luxury	CLZ/CLL	-	-	-	-	-	-	-	-	S	S
LOAD FLOOR - Rear fold-flat (Quad Cab and Crew Cab only; included with premium cloth and leather seats)	CVN	-	-	-	P	P	P	S	P	P	P
MEMORY SYSTEM - Seats, mirrors, pedals, radio presets	LEV	-	-	-	-	-	-	-	S	S	S
PEDALS - Non-adjustable	XA8	S	S	S	S	-	-	S	-	-	-
- Power-adjustable	XAP	-	-	-	-	S	S	-	-	-	-
- Power-adjustable with memory	XAM	-	-	-	-	-	-	-	S	S	S
SEATS - Manual-adjusting driver and front-passenger	JP8	S	S	S	-	-	-	-	-	-	-
- Seat belt, front, shoulder height-adjustable	CGD/LAX	S	S	S	S	S	S	S	S	S	S
- Power 10-way driver (included with premium cloth seats)	JRT	-	-	-	P	P	P	-	-	-	-
- Power 10-way driver and power 6-way passenger (included with *GJ leather seats)	JRM	-	-	-	-	P	P	S	-	-	-
- Power 10-way driver with memory and power 6-way passenger (included with leather-trimmed seats)	JRF	-	-	-	-	-	-	-	P	P	P
- Power 2-way lumbar adjuster (driver's seat only; included with premium cloth or leather-trimmed seats)	JPW	-	-	-	P	P	P	S	S	S	S
- Heated, driver and front-passenger, includes heated steering wheel (included with Heated Seats and Wheel Group; included with leather-trimmed seats)	CMA/NHS	-	-	-	P	P	P	S	P	P	P
- Ventilated front (included with leather-trimmed seats)	CAJ	-	-	-	-	P	P	-	P	P	P
- Heated, 2nd-row, Crew Cab only (included with leather-trimmed bucket seats)	JPZ	-	-	-	-	-	-	-	P	P	P
- Vinyl 40/20/40 split-bench front seat with folding front armrest/cup holder, floor-mounted storage tray on Crew Cab (Quad Cab and Crew Cab models include folding rear bench seat trimmed in vinyl)	*TX	S	S	S	-	-	-	-	-	-	-
- Cloth 40/20/40 split-bench front seat, front armrest with cup holder (Quad Cab and Crew Cab models include cloth folding rear bench seat; included with Popular Equipment Group)	*V9	P	-	P	-	-	-	-	-	-	-
- Premium cloth-trimmed 40/20/40 split-bench front seat, front armrest with cup holder, power 10-way driver's seat, power lumbar adjuster, front center-seat cushion storage, 115-volt auxiliary power outlet (Quad Cab and Crew Cab models include 60/40 split-folding rear bench seat with underseat storage and fold-flat load-floor storage)	*M9	-	-	-	S	-	-	-	-	-	-
- Premium cloth-trimmed low-back bucket seats, power 10-way driver's seat, power lumbar adjuster, full-length floor console, 115-volt auxiliary power outlet (Quad Cab and Crew Cab models include 60/40 split-folding rear bench seat trimmed in cloth with underseat storage and fold-flat load-floor storage)	*MJ	-	-	-	0	-	-	-	-	-	-
- Premium cloth/vinyl-trimmed high-back heated bucket seats with embossed tread pattern, power 10-way driver and 6-way passenger, power lumbar adjuster, full-length floor console, 115-volt auxiliary power outlet (includes 60/40 split-folding rear bench seat trimmed in cloth/vinyl with underseat storage and fold-flat load-floor storage)	*N7	-	-	-	-	-	-	S	-	-	-
- Premium cloth/vinyl-trimmed high-back heated bucket seats, power 10-way driver's seat, power lumbar adjuster, full-length floor console, Heated Seats and Wheel Group, 115-volt auxiliary power outlet (Quad Cab and Crew Cab models include 60/40 split-folding rear bench seat trimmed in cloth/vinyl with underseat storage and fold-flat load-floor storage)	*AJ	-	-	-	-	S	S	-	-	-	-
- Leather-trimmed high-back, heated and ventilated bucket seats, includes power 10-way driver and power 6-way passenger, power lumbar adjuster, full-length floor console, 115-volt auxiliary power outlet (Quad Cab and Crew Cab models include 60/40 split-folding rear bench seat trimmed in vinyl with underseat storage and fold-flat load-floor storage; not available on Regular Cab)	*CJ	-	-	-	-	0	0	-	-	-	-
- Leather-trimmed 40/20/40 split-bench heated and ventilated front with power 10-way/memory for driver and power 6-way passenger, power lumbar adjuster, front center-seat cushion storage and folding center armrest with cup holder, 115-volt auxiliary power outlet (Quad Cab and Crew Cab models include 60/40 split-folding rear bench seat trimmed in vinyl with underseat storage and fold-flat load-floor storage)	*VL	-	-	-	-	-	-	-	S	-	-
- Leather-trimmed high-back, heated and ventilated bucket seats, includes power 10-way driver and power 6-way passenger, power lumbar adjuster, full-length floor console, 115-volt auxiliary power outlet and heated 2nd row on Crew Cab models (Quad Cab and Crew Cab models include 60/40 split-folding rear bench seat trimmed in vinyl with underseat storage and fold-flat load-floor storage)	*GJ	-	-	-	-	-	-	-	0	-	-
- Premium leather with laser-etched design, high-back heated and ventilated bucket seats, includes power 10-way driver and power 6-way passenger, power lumbar adjuster, premium full-length floor console, 115-volt auxiliary power outlet, heated 2nd-row seats; includes 60/40 split-folding premium leather rear bench seat with underseat storage (available only in Canyon Brown)	*XJ	-	-	-	-	-	-	-	-	S	-
- Premium leather high-back, heated and ventilated bucket seats, includes power 10-way driver and power 6-way passenger, power lumbar adjuster, premium full-length floor console, 115-volt auxiliary power outlet, heated 2nd-row seats; includes 60/40 split-folding premium leather rear bench seat with underseat storage and fold-flat load-floor storage (available in Canyon Brown or Cattle Tan)	*DJ	-	-	-	-	-	-	-	-	0	-
- Premium leather high-back, heated and ventilated bucket seats, includes power 10-way driver and power 6-way passenger, power lumbar adjuster, premium full-length floor console, 115-volt auxiliary power outlet, heated 2nd-row seats; includes 60/40 split-folding premium leather rear bench seat with underseat storage and fold-flat load-floor storage (available only in Black)	*UL	-	-	-	-	-	-	-	-	-	S
STEERING WHEEL - Urethane	SCF	S	S	S	-	-	-	-	-	-	-
- Leather-wrapped with audio control buttons	SCV/SCB	-	-	-	S	S	S	S	S	-	-
- Leather-wrapped, genuine wood, heated, with audio control buttons	SC3	-	-	-	-	-	-	-	-	S	S
- Heated (included with Heated Seats and Wheel Group)	NHS	-	-	-	P	P	P	S	S	S	S
STORAGE - Front center-seat cushion (included with optional CD player, included with *M9 and *VL seats)	CVH	P	P	P	P	-	-	-	P	-	-
- Front, behind the seats (Regular Cab only)	CU3	S	-	S	S	S	S	-	-	-	-
- Rear, in-floor bins, two with removable liners (Crew Cab only)	CB9	S	-	S	S	S	S	S	S	S	S
- Rear, underseat compartment (Quad Cab and Crew Cab models only)	CUE	S	S	S	S	S	S	S	S	S	S
- Dual glove boxes with closing doors	NA	-	-	-	S	S	S	S	S	S	S
SUNROOF - Power (Quad Cab and Crew Cab models only)	GWA	-	-	-	0	0	0	0	0	0	0
WINDOWS - Manual (Regular Cab only)	JF8	S	-	S	-	-	-	-	-	-	-
- Power, front with driver's one-touch down (Regular Cab only; included with Power and Remote Entry Group)	JPY	P	-	P	S	S	S	-	-	-	-
- Power, front and rear with driver's one-touch down and up (Quad Cab and Crew Cab models only)	JP3	S	S	S	S	S	S	S	S	S	S
- Rear backlight, fixed (standard on Regular Cab models)	GJD	S	S	S	S	S	S	-	-	-	-
- Rear backlight, sliding (Regular Cab only)	GFD	0	-	0	0	0	0	-	-	-	-
- Rear backlight, power sliding (Quad Cab and Crew Cab models only)	GFE	-	-	-	S	S	S	S	S	S	S
- Rear defroster (with power sliding rear backlight only)	GFA	-	-	-	0	0	0	0	0	0	S

S = Standard, 0 = Optional, P = Part of package, - = Not available.  
Note: some features and/or applications may be late availability.





**RAM 1500 BUYER'S GUIDE**

	Sales Code	Tradesman® Reg/Quad/Crew	EcoDiesel HFE Quad Cab®	Express Reg/Quad/Crew	Big Horn® Reg/Quad/Crew	Sport Reg/Quad/Crew	Night Reg/Quad/Crew	Rebel® Crew Cab	Laramie® Quad/Crew	Laramie Longhorn® Crew Cab	Limited Crew Cab
		B	E	J	S	L	Q	W	H	K	V
<b>CPOS PACKAGE</b>											
<b>UCONNECT® MULTIMEDIA</b>											
CONNECTIVITY – Auxiliary input jack for mobile devices	RSU	S	S	S	S	S	S	S	S	S	S
– USB 1.5-amp fully functioning port	RSX	S	S	S	S	S	S	S	S	S	S
– USB 2.5-amp charging-only port (included with *V9, *M9, *MJ seats and Uconnect 5.0 radio)	RS3	P	–	P	P	S	S	S	S	S	S
RADIOS – Radio 3.0 AM/FM	RA1	S	S	S	–	–	–	–	–	–	–
– Uconnect 3.0 AM/FM/Bluetooth® Voice Command <sup>14</sup>	UA1	0	–	0	–	–	–	–	–	–	–
– Uconnect 5.0 AM/FM/Bluetooth (included with Black Express Group)	RA2	0	–	0/P	–	–	–	–	–	–	–
– Uconnect 8.4 AM/FM/Bluetooth/Access <sup>19</sup>	RA3	–	–	–	S	S	S	S	S	–	–
– Uconnect 8.4 NAV AM/FM/Bluetooth/Access <sup>19</sup> /NAV	RA4	–	–	–	0	0	0	0	0	S	S
RADIO CONTROLS – Steering wheel-mounted audio controls (included with leather-wrapped steering wheel)	RDZ	–	–	–	P	P	P	P	P	P	P
SINGLE-DISC CD PLAYER	RH1	0	0	0	0	0	0	0	0	0	0
SIRIUSXM® SATELLITE RADIO <sup>6</sup> – Included with Popular Equipment Group	RSD	P	–	P	S	S	S	S	S	S	S
SIRIUSXM TRAFFIC <sup>6</sup> – Included with Uconnect 8.4 NAV	RSS	–	–	–	P	P	P	P	P	P	P
SIRIUSXM TRAVEL LINK <sup>6</sup> – Included with Uconnect 8.4 NAV	RSM	–	–	–	P	P	P	P	P	P	P
SPEAKER SYSTEM – Six, standard	RCG	S	S	S	S	S	S	S	–	–	–
– Premium I; seven speakers and eight-channel amplifier (Regular Cab only)	RCK	–	–	–	–	S	S	–	–	–	–
– Premium II; 10 speakers including a subwoofer and 12-channel amplifier (included with Premium Sound Group or Black Sport Group; Quad Cab and Crew Cab models only)	RC3	–	–	–	0	P	P	0	S	S	S
UCONNECT ACCESS <sup>19</sup> – Requires Uconnect 8.4	RS7	–	–	–	P	P	P	P	P	P	P
UCONNECT BLUETOOTH CONNECTIVITY – Includes hands-free phone <sup>14</sup> , Streaming Audio, Voice Command <sup>14</sup> and Text Message Reader <sup>20</sup> (included with Uconnect 3.0 or 5.0 or 8.4 or 8.4 NAV)	XRB	P	–	P	P	P	P	P	P	P	P
<b>SAFETY AND SECURITY</b>											
AIR BAGS <sup>18</sup> – Advanced multistage front	CG3	S	S	S	S	S	S	S	S	S	S
– Supplemental side-curtain	CGS	S	S	S	S	S	S	S	S	S	S
– Supplemental front-seat side-mounted	CJ1	S	S	S	S	S	S	S	S	S	S
BRAKES – Power-assisted 4-wheel antilock disc	BRT	S	S	S	S	S	S	S	S	S	S
ELECTRONIC STABILITY CONTROL (ESC) <sup>4</sup> – Includes 4-wheel ABS, Brake Assist, All-Speed Traction Control, Rain Brake Support, Ready Alert Braking, Electronic Roll Mitigation, Hill Start Assist and Trailer Sway Damping <sup>4</sup>	BNB	S	S	S	S	S	S	S	S	S	S
PARKSENSE® REAR PARK ASSIST <sup>5</sup>	XAA	–	–	–	–	–	–	S	–	–	–
PARKSENSE FRONT AND REAR PARK ASSIST <sup>5</sup> – Not available on Regular Cab	XAG	–	–	–	S	0	0	–	0	S	S
PARKVIEW® REAR BACK-UP CAMERA <sup>5</sup> – With dynamic grid lines (grid lines not available with 3.0 radios)	XAC	0	–	0	S	S	S	S	S	S	S
REMOTE KEYLESS ENTRY WITH ALLSECURE® – Controls for power door locks, tailgate and RamBox® System (when equipped), illuminated entry system, panic alarm; includes two transmitters (included with Popular Equipment Group and Power and Remote Entry Group)	GXM	P	–	P	S	S	S	S	S	S	S
REMOTE START SYSTEM	XBM	–	–	–	S	S	S	S	0	S	S
SECURITY ALARM	LSA	–	–	–	S	S	S	S	S	S	S
TRAILER BRAKE CONTROL – Fully integrated electronic (included with Trailer-Tow Mirrors and Brake Group)	XHC	0/P	–	0/P	0/P	0/P	0/P	0/P	0/P	0/P	0/P
<b>PACKAGES/EQUIPMENT GROUPS</b>											
BLACK EXPRESS GROUP – Includes Popular Equipment Group, Power and Remote Entry Group, Black badges, Black bezel headlamps, Black painted grille, Uconnect 5.0 radio and 20-inch Black painted wheels	AMQ	–	–	0	–	–	–	–	–	–	–
BLACK SPORT GROUP – Includes Sport performance hood, Dual-Zone Automatic Temperature Control (ATC), Black badges, premium nine-speaker sound system with subwoofer and 20-inch Black semi-gloss aluminum wheels	AGC	–	–	–	–	0	–	–	–	–	–
CHROME APPEARANCE GROUP – Includes chrome front and rear bumpers, chrome grille surround and 17-inch painted aluminum wheels	AED	0	–	–	–	–	–	–	–	–	–
CHROME BUMPER PACKAGE – Includes body-color wheel flares and chrome front and rear bumpers	AST	–	–	–	–	–	–	–	–	–	0
COLD WEATHER GROUP – Includes engine block heater and winter front grille cover (requires EcoDiesel V6)	ADE	0	0	–	0	–	–	–	0	0	0
CONVENIENCE GROUP – Includes Passive Entry/Keyless Enter 'n Go <sup>11</sup> rain-sensitive wipers and Auto High-Beam Headlamp Control	ADC	–	–	–	–	0	0	–	0	S	S
HEATED SEATS AND WHEEL GROUP – Includes heated cloth seats and heated steering wheel	AGF	–	–	–	0	S	S	–	–	–	–
LUXURY GROUP – Includes LED Bed Lighting, switchable dome lamp, ashtray lamp, glove box lamp, underhood lamp, illuminated vanity mirror, auto day/night mirror, exterior mirrors with signal and puddle lamps, overhead console with Universal Garage Door Opener, leather-wrapped steering wheel and full-color 7-inch Driver Information Display	ADA	–	–	–	–	S	S	0	–	–	–
POPULAR EQUIPMENT GROUP – Includes cloth 40/20/40 bench seat, carpeted flooring, remote keyless entry, floor mats and SiriusXM Satellite Radio <sup>6</sup> (included with Black Express Group)	AJY	0	–	0/P	–	–	–	–	–	–	–
POWER AND REMOTE ENTRY GROUP – Includes premium vinyl door trim, remote keyless entry, foldaway Black power heated mirrors, power windows with front one-touch down and power locks (Regular Cab only; included with Black Express Group)	AJH	0	–	0/P	–	–	–	–	–	–	–
PREMIUM SOUND GROUP – Includes Premium Surround Sound Speaker System (Quad Cab and Crew Cab only)	ANF	–	–	–	–	0	0	–	–	–	–
PROTECTION GROUP – Includes tow hooks, front suspension and transfer case skid plates (4x4 models only)	ADB	0	–	–	0	–	–	0	0	0	–
R/T PACKAGE – Includes Sport performance hood, 3.92 axle ratio and antispin differential, P285/45R22 BSW All-Season tires and 22 x 9-inch forged polished aluminum wheels (Regular Cab 4x2 6' 4"-box models only)	NA	–	–	–	–	S	–	–	–	–	–
TRAILER-TOW MIRRORS AND BRAKE GROUP – Includes electronic trailer brake controller, Class IV hitch receiver and 7 x 11-inch trailer-tow mirrors	AHC	0	–	0	0	0	0	0	0	0	0

S = Standard, 0 = Optional, P = Part of package, – = Not available.  
 Note: some features and/or applications may be late availability.





## RAM 1500 SPECIFICATIONS



### RAM 1500 TOWING—SAE J2807 COMPLIANT

Maximum loaded trailer weights (when properly equipped)

POWERTRAIN	AXLE RATIO	GCWR	REGULAR CAB		QUAD CAB*		CREW CAB					
			6'4" BOX		8' BOX		6'4" BOX		5'7" BOX		6'4" BOX	
			4x2	4x4	4x2	4x4	4x2	4x4	4x2	4x4	4x2	4x4
3.6L PENTASTAR® V6 / 8-SPEED AUTO	3.21	9,850	4,970	4,750	4,770	4,580						
	3.55	12,200	7,260	7,050								
	3.55	12,400			7,270	7,080						
	3.55	12,900					7,600	7,420	7,510	7,210		
3.0L ECODIESEL V6 / 8-SPEED AUTO	3.55	13,750			8,240	8,030	7,960	7,750	7,870	7,580		7,540
	3.92	13,750			8,240	8,030	7,960	7,750	7,870	7,580		7,540
	3.92	14,550										8,340
	3.92	14,750			9,210	9,030	8,960	8,750	8,870	8,580		
5.7L HEMI® V8 / 8-SPEED AUTO	3.92	10,250	5,030									
	3.21	13,800	8,610	8,380	8,470	8,260	8,190	8,000	8,070	7,990	8,050	7,780
	3.92	14,350	9,160	8,930								
	3.92	15,950			10,620	10,410	10,340	10,150	10,220	10,140	10,200	9,830

### RAM 1500 PAYLOAD

Maximum payload capacities (when properly equipped)

POWERTRAIN	GVWR	REGULAR CAB		QUAD CAB		CREW CAB					
		6'4" BOX		8' BOX		6'4" BOX		5'7" BOX		6'4" BOX	
		4x2	4x4	4x2	4x4	4x2	4x4	4x2	4x4	4x2	4x4
3.6L PENTASTAR V6 / 8-SPEED AUTO	6,025	1,500									
	6,300		1,560								
	6,600			1,880	1,690						
	6,800					1,880	1,700	1,820	1,630		
3.0L ECODIESEL V6 / 8-SPEED AUTO	6,600			1,510	1,290						
	6,945					1,500					
	6,950					1,590	1,380	1,530	1,320		1,250
5.7L HEMI V8 / 8-SPEED AUTO	6,200	1,350									
	6,350	1,590	1,390								
	6,600			1,690	1,480						
	6,900					1,760	1,570	1,680	1,510	1,640	1,450

Numbers in **Black boxes** reflect max ratings. 1. Payload and Max Trailer Weights are estimated values. 2. All weights are shown in lb unless otherwise stated. 3. Payload and Max Trailer Weight values are rounded to the nearest 10 lb. 4. Payload = GVWR - Base Weight. 5. Trailer Weight Rating and Tow Vehicle Trailing Weight are calculated as specified in SAE J2807. 6. Payload and Trailer Weight Rating are mutually exclusive. 7. GVWRs, GVWRs and GCWRs should never be exceeded. 8. The recommended tongue weight for a conventional hitch is 10 percent of the gross trailer weight. The maximum tongue weight for Class IV hitch receiver is limited to 1,100 lb. 9. Weight-distributing hitch is recommended for trailers over 5,000 lb.

### RAM 1500 INTERIOR DIMENSIONS

All dimensions are in inches (millimeters) unless otherwise noted

	REGULAR CAB	QUAD CAB	CREW CAB
SEATING CAPACITY, FRONT / REAR	3 / 0 or 2 / 0	3 / 3 or 2 / 3	3 / 3 or 2 / 3
<b>FRONT</b>			
HEAD ROOM	39.9 (1,013.5)	41.0 (1,041.4)	41.0 (1,041.4)
LEG ROOM	41.0 (1,041.4)	41.0 (1,041.4)	41.0 (1,041.4)
SHOULDER ROOM	66.0 (1,676.4)	66.0 (1,676.4)	66.0 (1,676.4)
HIP ROOM	62.9 (1,598.7)	63.2 (1,605.3)	63.2 (1,605.3)
<b>REAR</b>			
HEAD ROOM	N/A	39.7 (1,008.4)	39.9 (1,013.5)
LEG ROOM	N/A	34.7 (880.9)	40.3 (1,023.3)
SHOULDER ROOM	N/A	65.7 (1,668.8)	65.7 (1,668.8)
HIP ROOM	N/A	62.9 (1,598.3)	63.2 (1,605.3)
<b>INTERIOR VOLUME</b>			
FRONT cu ft (cu m)	62.5 (1.8)	64.2 (1.8)	64.2 (1.8)
REAR cu ft (cu m)	N/A	52.4 (1.5)	61.1 (1.7)
TOTAL PASSENGER VOLUME (cu ft)	62.5	116.6	125.3

### RAM 1500 EXTERIOR DIMENSIONS

All dimensions are for base models only and in inches unless otherwise noted

	REGULAR CAB		QUAD CAB	CREW CAB	
	6'4" BOX	8' BOX	6'4" BOX	5'7" BOX	6'4" BOX
OVERALL BODY WIDTH	79.4	79.4	79.4	79.4	79.4
OVERALL HEIGHT (4x2 / 4x4)	74.6 / 75.2	74.4 / 75.0	77.2 / 77.7	76.9 / 77.5	76.8 / 77.4
OVERALL LENGTH	209.0	231.0	229.0	229.0	237.9
TRACK - FRONT (4x2 / 4x4)	68.0 / 68.2	68.0 / 68.2	68.0 / 68.2	68.0 / 68.2	68.0 / 68.2
TRACK - REAR (4x2 / 4x4)	67.5 / 67.5	67.5 / 67.5	67.5 / 67.5	67.5 / 67.5	67.5 / 67.5
WHEELBASE	120.5	140.5	140.5	140.5	149.4
BED HEIGHT	20.1	20.2	20.1	20.0	20.1
BED LENGTH	76.3	98.3	76.3	67.4	76.3
BED WIDTH, WALL-TO-WALL	66.4	66.4	66.4	66.4	66.4
BED WIDTH, BETWEEN WHEELHOUSINGS	51.0	51.0	51.0	51.0	51.0





# AMERICA'S LONGEST-LASTING PICKUPS<sup>1</sup>

<sup>1</sup> Based on IHS Automotive VIO registration data for all brands of GVW 1 – 3 pickup trucks continuously sold in the U.S. since 1988. Dodge and Ram have the highest overall percentage still on the road. <sup>2</sup> Based on Standard Pickup class. EPA estimated 29 highway mpg based on EcoDiesel V6 4x2. Actual results may vary. <sup>3</sup> Based on latest available competitive information. Class based on light-duty pickups. <sup>4</sup> No system, no matter how sophisticated, can repeal the laws of physics or overcome careless driving actions. Performance is limited by available traction, which snow, ice and other conditions can affect. When the ESC warning lamp flashes, the driver needs to use less throttle and adapt speed and driving behavior to prevailing road conditions. Always drive carefully, consistent with conditions. Always wear your seat belt. <sup>5</sup> Always look before proceeding, electronic drive aid is not a substitute for conscientious driving; always be aware of your surroundings. <sup>6</sup> SiriusXM subscriptions for audio and data services are sold by SiriusXM to follow your trial subscription. **If you decide to continue listening after your trial, the subscription plan you choose will automatically renew thereafter and you will be charged according to your chosen payment method at then-current rates.** Fees and taxes apply. To cancel, you must call SiriusXM at 1-866-635-2349. See the SiriusXM Customer Agreement for complete terms and more information at [siriusxm.com](http://siriusxm.com). All fees and programming subject to change. Your equipment and features for SiriusXM services will vary depending upon the vehicle you select and may be limited in select markets. <sup>7</sup> Wi-Fi subscription required. This feature is not intended for use by the driver while the vehicle is in motion. Always drive carefully. <sup>8</sup> Based on Standard Pickup class. Fuel economy based on EPA estimated 29 highway mpg on EcoDiesel V6 4x2. Actual results may vary. Torque comparison based on latest available competitive information. <sup>9</sup> Based on EPA estimated 29 highway mpg on Ram 1500 EcoDiesel V6 4x2 and standard 26-gal. fuel tank. Actual results may vary. <sup>10</sup> Transferable. See dealer for complete details and a copy of the 5-Year/100,000-Mile Diesel Powertrain Limited Warranty. <sup>11</sup> Transferable. See dealer for complete details and a copy of the 5-Year/60,000-Mile Gas Powertrain Limited Warranty. <sup>12</sup> Vehicle must be within the United States, have network coverage and must be registered with Uconnect Access with an active subscription that includes the applicable feature and you must fulfill minimum subscription requirements. It must also be equipped with features that enable remote commands, such as keyless entry, and must be in active and usable cellular range. The Uconnect Access App must be installed and launched on your mobile device to use these remote commands. Remote features are available only on vehicles that are properly equipped. Check state and local laws regarding the use of remote start systems. <sup>13</sup> Siri® Eyes Free requires an iPhone® mobile device equipped with the Siri feature. Certain features not available while the vehicle is in motion. iPhone must be within active cellular range. Customer's existing iPhone data rates apply to Internet-supported features. <sup>14</sup> Requires a mobile phone equipped with the Bluetooth Hands-Free Profile. Visit [UconnectPhone.com](http://UconnectPhone.com) for system and device compatibility. <sup>15</sup> The 9-1-1 Call button will connect you directly with Emergency Assistance. If you accidentally press the button, you have 10 seconds to cancel the call by either pressing the 9-1-1 button on the rearview mirror or the Cancel button on the Uconnect touchscreen. <sup>16</sup> Provides direct-dial access to Roadside Assistance Service. Vehicle must be within the United States, have network coverage and must be registered with Uconnect Access with an active subscription that includes the applicable feature. Additional roadside assistance charges may apply. Check warranty for details. <sup>17</sup> Wi-Fi subscription required. Vehicle must be registered with Uconnect Access and fulfill minimum subscription requirements. Vehicle must be properly equipped and in active and usable cellular range for Wi-Fi usage. Wi-Fi Hotspot does not enable direct communication between multiple in-vehicle devices. Factors affecting the performance of Wi-Fi Hotspot include: cellular network, signal strength and quality, time of day, number of channels used by the service provider, type of connection, number of clients using Wi-Fi Hotspot and client device. This feature is not intended for use by the driver while the vehicle is in motion. Always drive safely. <sup>18</sup> The Advanced Front Air Bags in this vehicle are certified to the new U.S. Federal regulations for advanced air bags. Children 12 years old and younger should always ride buckled up in a rear seat. Infants in rear-facing child restraints should never ride in the front seat of a vehicle with a passenger front air bag. All occupants should always wear their lap and shoulder belts properly. <sup>19</sup> Uconnect Access is available only on equipped vehicles purchased within the contiguous United States and AK. Services can only be used where coverage is available, see coverage map for details. For a complete list of Uconnect Access services, please visit [http://www.driveuconnect.com/features/uconnect\\_access/packages](http://www.driveuconnect.com/features/uconnect_access/packages). <sup>20</sup> Voice Text Reply and Voice Texting features require a compatible mobile device enabled with Bluetooth Message Access Profile (MAP). iPhone and some other smartphones do not currently support Bluetooth MAP. Visit [UconnectPhone.com](http://UconnectPhone.com) for system and device compatibility. Ensure MAP is ON and incoming message notification is enabled. Vehicle must be registered for Uconnect Access and you must fulfill minimum subscription requirements. Also requires the use of a compatible smartphone that supports text messaging and Bluetooth. Visit [UconnectPhone.com](http://UconnectPhone.com) for system and device compatibility.

©2016 FCA US LLC. All Rights Reserved. Ram, Mopar, AllSecure, Big Horn, HEMI, Laramie, Laramie Longhorn, the Mopar Owner Connect design, Mopar Vehicle Protection, ParkSense, ParkView, Pentastar, Quad Cab, Ram 1500 Express, R/T, RamBox, Rebel, Sentry Key, the Ram's Head logo, TorqueFlite, Tradesman and Uconnect are registered trademarks, and Active-Level, HFE High Fuel Efficiency & Design and Keyless Enter 'n Go are trademarks of FCA US LLC.

Toyo is a registered trademark of TOYO TIRE & RUBBER CO., LTD. iPhone and Siri are registered trademarks of Apple Inc. Bluetooth is a registered trademark of Bluetooth SIG, Inc. Sirius, XM and all related marks and logos are trademarks of SiriusXM Radio Inc. Facebook and logo are registered trademarks of Facebook, Inc. The Twitter logo is a service mark of Twitter, Inc. Instagram and logo are registered trademarks of Instagram, Inc. YouTube and logo and Google+ and logo are registered trademarks of Google Inc. Pinterest and logo are registered trademarks of Pinterest, Inc. Yelp is a registered trademark of Yelp. Bilstein is a registered trademark of August-Bilstein GmbH & Co. Polaris is a registered trademark of Polaris Industries Inc. RANGER BOATS is a registered trademark of Ranger Boats, LLC. Grizzly is a trademark of Grizzly Coolers LLC.

About this catalog: Since the time of printing, some of the information you'll find in this catalog may have been updated. Ask your dealer for details. Some of the equipment shown or described throughout this catalog may be available at extra cost. Specifications, descriptions, illustrative materials and all competitive comparisons contained herein are as accurate as known at the time this publication was approved for printing. FCA US LLC reserves the right to discontinue models at any time or change specifications without notice or without incurring obligation. Options may be required in combination with other options. For the price of the model with the equipment you desire, or verification of specifications contained here, see your Ram dealer.

## JOIN IN



Join fellow Ram enthusiasts and tell your story by posting comments, participating in discussions, and sharing your photos and videos. Join our community on Facebook, Twitter, YouTube, Google+, Pinterest and Instagram.

 **RAM OUTFITTER** [RAMTRUCKS.COM/OUTFITTER](http://RAMTRUCKS.COM/OUTFITTER)



# RAMTRUCKS.COM





**RAM**

**RAMTRUCKS.COM**

